



# 450LXi

## Maintenance Manual

BLUE BIRD  
**Coachworks®**



# Introduction

Dear Coachworks Owner:

Welcome - Thanks for choosing a Blue Bird Coachworks Motor Home!

We want to personally welcome you to our Family of Friends and we invite you to visit us at our Fort Valley facilities whenever you wish. We are always happy to see you and we are deeply interested in your experiences as you use and enjoy your Coachworks motor home. We recognize that it is our relationship to you, the Coachworks owner, which contributes most to the prestige of ownership of this finest over-the-road motor home.

We trust that as you become more intimately acquainted with your new motor home, the sound, careful thoughts behind every aspect of its design will become increasingly evident and your initial decision to choose Coachworks will be positively reinforced with every mile.

We encourage that you take the time to become familiar with this introduction section before taking your first trip in your new motor home. Inside you will find information that will be beneficial on future trips with your motor home such as: vehicle loading, emergency exits, safety information, etc.

Coachworks acknowledges the good faith you have demonstrated in choosing this product. All of us at Coachworks take great pride in our handiwork and want to do everything possible to beget in you what has become the Coachworks experience; the deep satisfaction that comes from years of a sure confidence of having chosen the very best.

BLUE BIRD  
**Coachworks®**  
**Limited Warranty**  
**450 LXi Recreational Vehicle**

Blue Bird Coachworks, a division of the Blue Bird Body Company, warrants each 450 LXi to the original purchaser to be free from defects in material and workmanship under normal use and service within the limits described below:

1. For a period of five (5) years/50,000 miles/80,000 kilometers, whichever occurs first, from date of delivery to the original purchaser, Coachworks warrants the:
  - a. Chassis frame rails and cross members to be free from defects in structural integrity (breaking or cracking).
  - b. Body shell (those structural metal components welded or riveted together forming floor, sidewalls, roof, front and rear sections) to be free from defects in structural integrity (breaking or cracking) including rust-through.
  - c. Paint adhesion to the body shell (those structural components forming side walls, roof, front and rear sections). Paint failures caused by corrosive atmospheric conditions and road chemicals are specifically not covered.
2. For a period of three (3) years/36,000 miles/60,000 kilometers, whichever occurs first from the date of delivery to the original purchaser, Coachworks warrants all other components not covered in sections 1 and 3 except diesel engines, automatic transmissions, tires and batteries, which are warranted by their manufacturers.
3. For a period of one (1) year from the date of delivery to the original purchaser, Coachworks warrants plasma televisions installed by Coachworks.

For demonstrators, the delivery date to the dealer will be the warranty start date. Mileage accumulated by the factory or dealer apply to any warranty mileage limits stated above. This limited warranty applies to the original purchaser during the warranty period. A transfer request and fee are required within thirty (30) days of resale to transfer the warranty.

Blue Bird Coachworks' obligation covered in this limited warranty is limited to the repair or replacement of such parts as shall, under normal use and service, appear to have been defective in workmanship or material. Without restricting the generality of this limitation, loss of use, commercial loss, maintenance, towing charges, lodging, telephone calls, inconvenience, and loss of time are specifically not covered. This warranty shall not apply to any parts or components which must be repaired or replaced during the warranty period as a result of what is, in the opinion of Coachworks, normal wear and/or deterioration in the course of normal operations and use, accident damage, misuse and/or abuse.

If distributors, dealers or customers have any vehicle modifications or equipment installations performed without the written approval of Coachworks to the extent of modifications or equipment installations adversely affect other vehicle components or performance. Coachworks shall not accept any product liability or claims under the terms of the limited warranty. These claims become the sole responsibility of the company performing the modifications and/or installations.

ANY IMPLIED WARRANTIES, INCLUDING THOSE OF MERCHANTABILITY OR FITNESS, ARE LIMITED TO THE WARRANTY PERIOD OF THIS WRITTEN WARRANTY. BLUE BIRD COACHWORKS SHALL NOT BE LIABLE FOR INCIDENTAL OR CONSEQUENTIAL DAMAGES RESULTING FROM BREACH OF THIS WRITTEN WARRANTY OR ANY IMPLIED WARRANTY. NO PERSON, INCLUDING SALESPEOPLE, DEALERS, SERVICE CENTERS, OR FACTORY REPRESENTATIVES OF BLUE BIRD COACHWORKS, IS AUTHORIZED TO MAKE ANY REPRESENTATION OR WARRANTY CONCERNING COACHWORKS PRODUCTS EXCEPT TO REFER TO THIS LIMITED WARRANTY.

Blue Bird Coachworks reserves the right to make changes in design and changes or improvements upon its products without imposing any obligations upon itself to install the same option upon products theretofore manufactured. Defects shall be repaired promptly after discovery of the defect and within the warranty period as stated herein. All claims for warranty adjustments must be received by Blue Bird Coachworks not later than 30 days after the repair date, and shall be channeled through an authorized Blue Bird Coachworks dealer or factory representative. Any suit alleging a breach of this limited warranty or any other alleged warranty must be filed within one year of breach.

All rights under this limited warranty shall be governed by the law of Georgia, U.S.A.

**NOTE: This information was correct at time of printing. For any vendor changes made to equipment and/or manual after printing date refer to the actual vendor owner manual supplied with motor home.**

**Blue Bird Coachworks**

One Wanderlodge Way • Fort Valley, Georgia 31030, U.S.A.

North American (USA & CAN)

Eff: 09/2002 (2003YM)

Rev: 12/2004

WLCN(eng)

Policy: W2

# INTRODUCTION

This section of your Owner's Manual contains general hints and recommendations for using your motor home. Checklists and suggestions are offered which cover just about every phase of motor home travel.

The remaining sections of this manual describe the operation and use of the individual items and systems which comprise your motor home.

Manufacturer's manuals for components and appliances are included in your owner's kit. If the information you need is not contained in this manual, refer to the specific manufacturers literature supplied in the owner's kit.

We hope that this manual will help answer questions that may arise about the use, operation and maintenance of your motor home. Any suggestions or recommendations that you might have for including or expanding on material of interest will be carefully considered for incorporation in future publications. We are always interested in providing our motor home owners with the most current and comprehensive information about their product.

## *Some Other Thoughts to Consider before Travel*

- Automobile insurance to cover you and your family.
- Avoid cash. Use traveler's checks and credit cards wherever possible.
- Confirm reservations well in advance of arrival.
- Make a clothing check list for everyone.

## **Citizen's Band Transceiver**

You might also bear in mind that your motor home is equipped with a CB unit (Citizen's Band receiver-transmitter) In the event of an emergency situation which requires outside assistance; remember to call for help on Channel 9. This channel is restricted to emergency use only and it is monitored 24 hours per day! Don't hesitate to use your CB if you see someone else in need of assistance.

## **Hot Weather Operation**

Wherever possible, choose a shaded parking site so that the motor home will be cooler during the hottest part of the day. The optional patio awning will be especially useful in lowering inside temperature. Air conditioning units are indispensable in hot climates. Keep in mind that their proper operation depends on adequate line voltage. Low voltage causes motors to run hotter and reduces compressor motor life. Supply voltage in some campgrounds may not be as high as necessary, especially where there are heavy loads on the lines from other air conditioners. Check the right hand overhead auxiliary panel 120 VAC meters when in doubt.

## **Cold Weather Operation**

If frost or condensation accumulates in closets or cabinets during long periods of cold weather operation, leave the doors to these areas slightly ajar to provide air circulation. Be sure that roof vents are open when using the cook top.

## **Campground Courtesy**

Don't forget the "Golden Rule". Being considerate of your neighbors will help make friends. A few of the "do's" and "don'ts" are:

- Good housekeeping – put all litter in the proper receptacles and leave your site neat and clean.
- Don't allow your water or sewer hook-ups to leak.
- Respect your neighbor's desire to retire at an early hour. Avoid loud noises and bright lights after dark.
- Drive slowly through camp areas at any hour for the safety of pedestrians.

## **Insurance**

As with your automobile, it is important that you have adequate protection with insurance coverage for personal liability, property damage, comprehensive, collision, medical payments, loss of use, etc.

## Canadian and Mexican Insurance

Insurance for travel in Canada can usually be covered by your present U.S. policy for the recreational vehicle, often at no extra cost. Consult your individual company for procedures and be sure of your coverage before entry.

For travel in Mexico (at the present time), there are no U.S. insurance companies that can provide recognized Mexican coverage, with the exception of that required for travel through a narrow strip of Mexican territory in and around parts of entry and the U.S./Mexican border.

Mexican insurance is controlled and rates are set by the Mexican government. There are several reliable companies handling Mexican insurance, with similar rates for the necessary coverage. The principle differences between them are the “fringe benefits”, received in the form of informational travelogues and other helpful information, such as dining places considered acceptable for sanitary conditions, fuel stations, and so on.

Some insurance services include detailed route maps with “where to stay” recommendations and “things to see” mile-by-mile (or kilometer-by-kilometer post). While the rates set by Mexico may seem quite expensive at first glance, you usually end up not spending quite as much as expected because you can usually arrange to hold your state-side policy in abeyance during the same period you are in Mexico, thus not having to pay unnecessarily for double coverage. In addition, you may be able to obtain substantial refunds on the Mexican collision insurance after your return to the U.S. Be sure to obtain a certification from the park operator at each location in Mexico to certify the dates that your motor home was parked there. If your motor home is parked for most of the time, instead of constantly traveling, your refund may be a major portion of the original cost. This feature is referred to as the “in-storage” credit. (It is a good idea to always check with your insurance company before taking a trip to find out whether applicable insurance rules and regulations have changed. Keep up to date on your coverage.)

Carry insurance papers at all times!

## Safety Considerations

### Using LP Gas

Check for leaks at the connections on the LP gas system soon after purchase and initial filling of the LP tank; continued periodic checks of the system are recommended. Even though the manufacturer and dealer have already made tests for leakage, this check is advisable because of the vibrations encountered during travel. Apply a soapy water solution to the outside of gas piping connections to find gas leakage (bubbles). Do not use products that contain ammonia or chlorine. Usually, tightening of connections will be sufficient. If not, ask your authorized dealer service to make the needed repairs. Liquefied Petroleum Gas (LPG) is heavier than air. Leaking gas tends to flow to low places, and will sometimes pocket in a low area. LP gas can usually be detected by an identifiable odor characteristic to garlic.

#### CAUTION!!

Never light a match or allow any open flame in the presence of leaking gas! Be sure that the main LP gas supply valve is closed or galley panel switch is OFF during refueling to prevent accidental ignition of gas fumes by appliance igniters.

#### WARNING!!

When motor home is to be stored in a confined area, turn off the LPG at the main tank shutoff valve, or more conveniently, at the galley systems control panel. Your Wanderlodge has been provided with an automatic 80% fill valve to protect you from the dangers of an overfilled LPG tank.

## Electrical Systems

Your motor home has been engineered and checked for your complete electrical system safety. The motor home is wired with Multiplex wiring throughout. Circuit breakers and fuses are installed to protect electrical circuits from overloading. Before making modifications or additions to the electrical system, consult your dealer for assistance in obtaining a safe and secure installation. For more information on the wiring system refer to Electrical Information found later in manual.

Do not “jump” circuit protectors!

## Emergency Stops

Always carry road flares and/or reflective triangular highway warning markers for emergency warning display. Pull off the roadway as far as possible when changing flats or for other emergency situations. Turn on your hazard warning flashers when parked alongside a roadway, even if only for a short while. Have your motor home occupants leave the vehicle and stand clear of the area when parked on the edge of a highway.

## In Case of Tire Blowout

As a result of extensive tests, leading tire manufacturers recommend the following when a blowout occurs:

1. Quickly step on the gas
2. Adjust steering as needed.
3. Stay off the brakes.
4. Keep driving until you find a safe place to pull over.

## Engine Exhaust Gas

Avoid inhaling exhaust gases because they contain carbon monoxide, which by itself is colorless and odorless. Carbon monoxide is a dangerous gas that can cause unconsciousness and is potentially lethal. If at any time you suspect that any exhaust fumes are entering the passenger compartment, have the cause determined and corrected as soon as possible.

The best protection against carbon monoxide entry into the vehicle body is properly maintained engine exhaust system, body and ventilation system. It is a good practice to have the exhaust system and body inspected by a competent mechanic each time the vehicle is raised for lubrication or oil change. It should also be inspected whenever a change is noticed in the sound of the exhaust system, and if the exhaust system, underbody or rear of the vehicle has been damaged.

To allow proper operation of the vehicle's ventilation system, keep ventilation inlets clear of snow, leaves or other obstructions.

Sitting in a parked vehicle with the engine on for extended periods of time, without proper ventilation, is not recommended!

## More Safety Considerations

- Sanitize fresh water supply system periodically.
- Prevent water connection fittings from contacting the ground or drain the hose to reduce chances of contamination.
- Consider using a qualified technician for repairing gas or electrical appliances.
- Check fire extinguishers periodically for proper charge.
- Avoid overloading your vehicle.
- Be careful not to cause an improper load distribution which can adversely affect road ability.
- Ensure that tires are in good condition and properly inflated at all times.
- Under-inflated tires overheat and are prone to blowouts!
- Check and tighten wheel lug nuts; manufacturer recommends after first 50-100 miles and every 1,000 miles thereafter.

## Emergency Exits

Sliding windows, which can be easily opened, may be used as an emergency exit. Squeeze the window latch and slide the window open. Emergency exit windows are identified by an EXIT decal on the glass.

### Owner's Manual Requirements

The minimum required educational information in the owner's manual shall include:

1. A sample of the weight label's contents affixed to the unit as appropriate.
2. An explanation of the following:
  - Vehicle weight distribution
  - How to weigh the vehicle
    - » These definitions:
      - » Gross Axle Weight Rating (GAWR)
      - » Gross Combination Weight Rating (GCWR)
      - » Gross Vehicle Weight Rating (GVWR)
      - » Unloaded Vehicle Weight (UVW)
      - » Net Carrying Capacity (NCC)
3. Towing guidelines.





**MOTOR HOME WEIGHT INFORMATION** *(to be filled out by owner for future reference)*

Model \_\_\_\_\_

GVWR \_\_\_\_\_

UVW \_\_\_\_\_

NCC \_\_\_\_\_

GCWR \_\_\_\_\_

**GVWR**

(Gross Vehicle Weight Rating) means the maximum permissible weight of this motor home. The GVWR is equal to or greater than the sum of the Unloaded Vehicle Weight plus the Net Carrying Capacity.

**UVW**

(Unloaded Vehicle Weight) means the weight of this motor home as built at the factory with full fuel, engine oil, and coolants. The UVW does not include cargo, fresh water, LP gas, occupants, or dealer installed accessories.

**NCC**

(Net Carrying Capacity) means the maximum weight of all occupants including the driver, personal belongings, food, fresh water, LP gas, tools, tongue weight of towed vehicle, dealer installed accessories, etc., that can be carried by this motor home. (NCC is equal to or less than GVWR minus UVW).

**GCWR**

(Gross Combination Weight Rating) means the value specified by the motor home manufacturer as the maximum allowable loaded weight of this motor home with its towed trailer or towed vehicle.

This motor home is capable of carrying up to 98 gallons of fresh water (including water heater) for a total of 816 pounds. Reference: Weight of fresh water is 8.33 lbs./gal.; Weight of LP gas is 4.5 lbs./gal. (average).

**CONSULT WEIGHT DECAL LOCATED IN MOTOR HOME FOR ACTUAL WEIGHTS****Vehicle Loading**

The Federal Certification Label, located inside and above the driver's windshield between the sun visor mounting brackets describes the maximum weight-carrying capacities of your motor home and for each axle, respectively abbreviated by "GVWR" and "GAWR".

The Gross Vehicle Weight Rating (GVWR) is the maximum motor home weight allowable with all systems filled and with passengers and supplies aboard.

Each axle also has a maximum load-bearing capacity referred to as the Gross Axle Weight Rating (GAWR).

The load capacity is the difference between the GVWR and the actual weight. This means that the total weight of all food, clothing, other supplies and passengers must not permit the load capacity to be exceeded.

To find the actual weight, with the motor home fully loaded, drive to a scale and read the weight on the front and rear wheels separately to determine axle loading. The load on each axle should not exceed its GAWR. If weight ratings are exceeded, move or remove items to bring all weights below the ratings.

When loading your motor home, store heavy gear first. Be sure to keep heavy gear on or as close to the floor as possible. Heavy items should be stored centrally to distribute the weight evenly between the front and the rear axles. Store only light objects on high shelves. Distribute weight to obtain even side-to-side balance of the loaded unit. Secure loose items to prevent weight shifts that could adversely affect the balance and road ability of the vehicle.

## Motor Home Service – Replacement Parts

A paint color label is located adjacent to the Federal Certification Label above the pilot's sun visor.

Data plates located on the rear of the chassis (raise rear engine compartment door for access) provide information useful for identifying your motor home if you are planning on ordering parts. Identification plates provide information such as:

1. Body Serial Number
2. Model Year
3. Body Service Number
4. Chassis Serial Number
5. Chassis Service Number

## Economical Driving

How you drive, where you drive and when you drive – these factors all have an effect on determining how many miles you can get from a gallon of fuel. Careful maintenance will also contribute to fuel economy.

Frequent stops and starts during a trip diminish miles per gallon. Planning even short shopping trips so you can take advantage of through-streets to avoid the traffic lights. Pace your driving like the professional drivers to avoid unnecessary stops.

An idling engine also consumes fuel. If you are faced with more than a few minutes wait, and you are not in traffic, it may be advisable to shut off the engine and re-start later.

A properly lubricated vehicle means less friction between moving parts. Consult the maintenance schedules for proper lubricants, lubrication intervals and general motor home maintenance scheduling.

Fuel economy is also related directly to the amount of work accomplished by the engine. Heavier loads require more power: Keep excess weight to a minimum.

## Cellular Phone Wiring

A roof mounted antenna and wiring (terminals in driver's area) are supplied for cellular phone hookup.

## Fog Lights

Clear fog lamps are mounted stationary in the front bumper. The fog lamps illuminate only with low beam headlights, provided the dash switch is activated.

## Traveling in Your Motor Home

### NOTE:

**1. Overall length - 44'-0", Interior Height - 83", Interior Width - 95", Exterior Width - 102", Wheelbase - 296", Front Overhang - 85", Rear Overhang 99", Cargo Carrying Capacity - 3,800 lbs. (depending on options).**

**2. It is recommended that compartment doors be locked so they do not open while in transit. There are many modern recreational vehicle parks with good facilities, including State, County and Federal Parks, where electrical, water and sewer connections are readily available. Directories are published which describe these parks in detail, and list available services and hookups.**

On overnight short weekend trips, your motor home has more than adequate holding tanks and water supply capacity in the event that campgrounds or parking sites are not equipped with these facilities.

On longer trips, where sewer connections and utility hookups are unavailable, it will be necessary to stop from time to time to dispose of holding tank wastes and replenish the water supply. Many gas stations (chain and individually-owned) have installed sanitary dumping stations for just this purpose.

When stopping for the night, park the motor home in a location that is relatively level and where the ground is firm. This will ensure your comfort as well as the leveling of your refrigerator (for most efficient operation).

Making a long trip is not very different from making a weekend excursion since everything you need is right at hand and you are home wherever you travel. When packing for an extended trip, try to avoid taking nonessential items.

When planning to stay in the same location for several days, weeks, or even months, be sure to maintain the motor home level. Use the leveling jacks system for this purpose. (See Leveling Jacks in Section 4-5 of this manual).

Hook up to the water supply by attaching the water hose to the commercial water supply inlet.

Plug the electrical cable into the shoreline receptacle. Be sure to observe all grounding and connection precautions!

Connect sewage hookup into the disposal facility.

## Winter Traveling

Certain precautions should be taken when traveling in your motor home during the cold winter months. Keep these suggestions in mind:

- Provide heat in the motor home at all times.
- Have a plentiful supply of LPG and diesel.
- If your stay is longer than overnight and you do not use the generator, try to have a shoreline hooked up to outside AC power.
- Minimize your use of electricity if 120 vac is unavailable.
- Leave cabinet doors and wardrobe doors slightly open at night to allow for proper air circulation.

Remember that low temperatures in combination with high winds will cause an equivalent chill temperature much below that indicated by your thermometer. For instance, with an outside temperature of zero degrees and a wind velocity of 10 miles per hour the equivalent chill temperature would be -20 °F!

There is no substitute for common sense when traveling in cold weather.

## General Storage Notes

Drawing draperies will reduce fading of rugs and upholstery. Leaving an air freshener agent will minimize odors from plastics and other materials. Slight opening of windows and vents will allow air circulation without worry of water entering. Covering wheels to eliminate direct rays of the sun on tires will reduce sidewall cracking.



**NOTE: Remove all items from the motor home that may freeze, including canned foods, miscellaneous liquids, etc. Remove all contents of the refrigerator/freezer, clean unit and leave doors ajar.**

## Countertop Care



### NOTES:

**Proper care of all countertops is the owner's responsibility. Scratches will occur if proper care is not implemented. Use cleaners and cleaning materials only recommended for these types of countertops. For example, using a scrub brushes or abrasive cleaners not recommended for this type of countertop could cause unsightly scratches.**

**Chipping of countertops is not covered under the warranty. Abrasive cleaners can cause chipping. Please take special care to avoid the chipping of countertops.**

## Reporting Safety Defects

If you believe your vehicle has a safety defect which could cause a crash or could cause injury or death, you should immediately inform the National Highway Traffic Safety Administration (NHTSA) in addition to notifying Blue Bird Wanderlodge.

If NHTSA receives similar complaints, it may open an investigation, and if it finds that a safety defect exists in a group of vehicles it may order a recall and remedy campaign. However, NHTSA cannot become involved in individual problems between you, your dealer, or Blue Bird Wanderlodge.

To contact NHTSA, you may either call the Auto Safety Hotline toll free at 1-800-424-9393 (or 366-0123 in Washington, D.C., area). Or write to: NHTSA, U.S. Department of Transportation, Washington, D.C. 20590. You can also obtain other information about Motor Vehicle Safety from the hotline.



# 1-1 Safety Features

## 1-1.1 Seat Belts and Restraint Systems

Pic of Pilot  
Safety Belt

### 1-1.1.1 Pilot and Co-Pilot Seats

The seatbelts in the pilot and co-pilot area use a 3-point system built into the seat itself. Seatbelts can be operated by grasping the shoulder buckle and moving it diagonally across the body and buckling it into the red and black receptacle. To remove simply press red button located at receptacle on seatbelt. Seatbelts automatically retract.

### 1-1.1.2 Living Room Area

Pic of Living Room  
Safety Belt

Two lap belts are provided at the sofa area in living room. These are manual non-retracting lap belts. These belts are operated by sitting between the belts and manually latching over your waist. Be sure to pull snug to your waist. An improperly adjusted seatbelt can be hazardous. To remove, simply press red button on seatbelt buckle.



**NOTE: these are the only four approved areas for seating while motor home is in transit.**

## 1-1.2 Smoke Alarm



Your motor home is equipped with two Safe T Alert smoke alarms located on the ceiling in the front and rear of the coach. These alarms meet U.L. Standard 217 and NFPA Standard 74 for operation of smoke detection devices.

### 1-1.2.1 Smoke Alarm Features

- Listed to UL 10/1/99 smoke alarm standard for Residential and Recreational Vehicle.
- New distinctive horn sound. Loud 85-decibel alarm horn.
- Test button checks smoke alarm functions.
- Alarm mute Models (S/SLL) feature Mute/Test button used to temporarily silence the alarm during ventilation. Alarm automatically resets.

**IMPORTANT SAFETY INFORMATION READ AND SAVE THESE INSTRUCTIONS**

### 1-1.2.2 Warnings and Cautions

- Smoke Alarms can only work if they are properly located, installed, and maintained, and if smoke reaches them. They are not foolproof.
- This alarm meets the 10/1/1999 UL standard for a new horn “alarm” pattern for smoke alarms. This sound is different than other Smoke Alarms you may have installed or may have heard in other locations. You must test this alarm and educate all members and guests of the residence of this different horn pattern.
- Different Smoke Alarm Sounds. If this unit replaces another 9 volt smoke alarm or is being used for additional protection where other smoke alarms are present, than everyone who might hear this alarm must be made aware of the different smoke alarms horn sounds.
- Smoke Alarms cannot work without power. Battery operated units cannot work if the batteries are missing, disconnected or dead, if the wrong type of batteries are used, or if the batteries are not installed correctly AC units cannot work if the AC power is cut off by an electrical fire, an open fuse, a circuit breaker or any other reason. If you are concerned about the limitations of battery or AC power, install both types of units.
- Smoke Alarms cannot detect fires if the smoke does not reach them. Anything preventing smoke from reaching the alarm may delay, or prevent an alarm. A smoke alarm cannot detect fire in the walls, chimney or roof unless and until a significant amount of smoke reaches the alarm. A closed door may prevent smoke from reaching an alarm on the other side of the door.
- Smoke Alarms may not be heard. Though the alarm horn in this unit meets or exceeds current UL standards, it may not be heard for many reasons. These include, but are not limited to: the unit is located outside a closed or partially closed door, residents recently consumed alcohol or drugs, the alarm is drowned out by other noise like the TV, stereo, traffic, weather, air conditioner or other appliances, residents are hearing impaired or sound sleepers.
- Smoke alarms have a limited life and are not foolproof. Smoke alarms will wear out over time like any appliance. Test your alarm at least once per week. Always replace detectors immediately if they are not working properly, if they display any type of problem, or prior to 10 years of use. They are not a substitute for property or life insurance.
- Smoke alarms may not have time to alarm before the fire causes damage, injury or even death. Examples of this include persons smoke in bed, children playing with matches or lighters, fires caused by violent explosions, natural causes like lighting, arson, escaping gas, overloaded electrical circuits, carelessness or by other safety hazards.
- Never disconnect the battery to silence the alarm.
- This unit will not alert hearing-impaired residents. Special alarms with flashing strobe lights are needed for the hearing impaired.
- This is a single station alarm. Do not attempt to connect this to any other device.
- Do not install this alarm over an electrical box. Do not use this detector as a replacement for an AC or AC/DC smoke alarm. Only use as an additional alarm for greater protection or as a replacement for a battery operated smoke alarm.

**CAUTION!!**

**Do not paint this unit. Paint may clog the openings to the sensing chamber and will prevent the unit from working properly**

**CAUTION!!**

**Do not stand too close to the unit when testing, silencing or during an alarm as the loud horn could damage your hearing. When testing move away when the horn starts sounding.**

**CAUTION!!**

This smoke alarm may not give adequate warning to those with physical limitations of any kind. Additional measures should be taken to insure their safe evacuation if a fire does occur. Install a professional fire alarm system that is connected to a call center.

**CAUTION!!**

**!!CAUTION: Smoke alarms sound their horns when they detect smoke. They do not detect heat, flame or gas. They will not operate if smoke does not reach them.**

### 1-1.2.3 Practice Fire Safety

Putting up smoke alarms is just one part of protection against fires. You must also reduce the chances of a fire starting and have a plan that you have practiced for everyone escaping if a fire does occur.

### 1-1.2.4 Escape Planning

- Determine a meeting location outside the coach where you can safely meet if a fire does occur.
- Familiarize everyone with the sound of this smoke alarm. Train them to safely exit the coach when the smoke alarm occurs.
- Update and practice your escape plan at least every six months. Inform guests and others of your plan and meeting place.
- Teach everyone how to check doors and not to open them if they are hot. Also to stay low and not to breathe smoke, fumes or gases.

### 1-1.2.5 What to Do When the Alarm Sounds

**WARNING!!**

**Never ignore any alarm. If the alarm sounds and you are not absolutely certain of the source of the smoke, get everyone out of the coach immediately.**

- Leave immediately by your plan of escape. Every second counts, do not waste time getting dressed or picking up valuables.
- Feel doors before opening them to see if they are hot. If a door is cool, open it slowly and check for fire and heat before you proceed. Do not open a hot door - use an alternate escape route.
- Stay close to the floor if air is smoky. Take short shallow breaths through a wet cloth if possible.
- Once outside, go to your selected meeting place and make sure everyone is there.
- Call the Fire Department from outside of the coach with the activated alarm, at a safe location.
- Do not return to coach until fire officials say that it is safe.

### 1-1.2.6 Operation, Testing and Maintenance

**Operation:** The smoke alarm is operating once the battery is correctly connected. The LED will flash every minute to show the battery is supplying power to the alarm. When production of combustion are sensed, the unit sounds a loud alarm which continues until the air is cleared.

**False Alarms “Mute” control:** Models (S/SLL) with the mute feature have the capability of temporarily reducing the sensitivity of the alarm circuit for approximately 10 minutes. This feature is to be used only when a known alarm condition such as smoke from cooking activates the smoke alarm. The smoke alarm horn is muted by pushing and holding the test button on the alarm cover for 5 seconds. The smoke alarm will automatically reduce sensitivity and the LED will “flash” every 10-20 seconds for approximately 10 minutes to indicate the alarm is in temporary mute condition. The smoke alarm is completely operational during the mute cycle and will alarm if the smoke density increases. After the 10 minute mute cycle the alarm will “beep” twice letting you know it has automatically returned to normal sensitivity.

#### CAUTION!!

Before using the “mute” feature, identify the source of smoke and be certain that safe conditions exist.

**Testing:** Test the alarm by pushing the test button on the smoke alarm cover for at least three seconds, until the alarm sounds. The alarm sounds if all electronic circuitry, horn and battery are working. If no alarm sounds, the unit has a defective battery or other failure and should be replaced immediately.

- Test each smoke alarm weekly to be sure it is installed correctly and operating properly.
- Stand at arm’s length from the smoke alarm when testing. The alarm horn is loud to alert you to an emergency. The alarm horn may be harmful to your hearing.
- The test button accurately tests all functions. Never use an open flame from a match or lighter to test this smoke alarm. You may ignite and set fire to the smoke alarm and your home.
- Test smoke alarm operation after vehicle has been in storage, before each trip, and at least once per week during use.
- Maintenance: This smoke alarm has been designed to be as maintenance free as possible, but there are a few simple things you must do to keep it working properly.
- Test each smoke alarm at least once a week.
- Keep a supply of approved 9 volt replacement batteries on hand.
- Test smoke alarms used in RVs after vehicle has been in storage, before each trip and at least once per week during use. Failure to test smoke alarm used in RV’s as described may remove your protection.
- Gently vacuum off any dust on the cover of the smoke alarm monthly with your vacuum’s soft brush attachment. Test unit once you have vacuumed the cover.
- Never use water, cleaners or solvents since they may damage the smoke alarm.
- Relocate the smoke alarm if it sounds frequently with unwanted alarms.
- When the battery becomes weak, the unit will “beep” about once a minute (the low battery warning). This, low battery warning should last for 30 days, but you should replace the battery immediately to continue your protection.
- Replace your Smoke Alarms at least every 10 years. This includes models with 10-year batteries (SA-668LL and SA-668SLL). Manufacturers date code is on the back of the Alarm.



### 1-1.2.7 Battery Information

**Battery Removal Indicator** - This Unit will not operate without a battery. When the battery is removed from the alarm, the battery flag in the compartment will pop up; therefore the alarm cannot be installed to the mounting bracket without a battery.

**Battery Replacement** - This smoke alarm requires one standard 9V battery. The Battery Gold Peak #1604P is approved (its reference: Gold Peak #16048; Eveready #522, #1222, #216; Duracell #MN1604 and #MN1604B). You may also use the long-life 10 Year Lithium battery Ultralife #89VL-J.

#### WARNING!!

Use only the replacement batteries listed. The unit may not operate properly, with other batteries. Never use rechargeable batteries since they may not provide a constant charge.



**NOTE:** Most carbon zinc batteries have an average service life of 1 year, most alkaline batteries have an average service life of 1-2 years. All the batteries specified above are acceptable replacement batteries for this unit.

**IMPORTANT!** Regardless of the manufacturer's suggested battery life, you **MUST** replace it immediately once the unit starts "beeping" ("the low battery warning").

### 1-1.3 LP-Gas Detector

The LP-Gas detector is provided for safety. The gas leakage detector sounds an alarm and closes down the main LPG supply in the event of an LPG leak. This unit does meet California requirements. It detects both LP-Gas and methane gas. Liquefied Petroleum (LP) Gas is heavier than air; methane gas is lighter than air. LP-Gas will settle to the lowest point, generally the floor of the motor home. Methane gas will rise. The gas detector is also sensitive to other fumes such as hair spray, of which most contain butane as the propellant. Butane, like propane, is heavier than air and will settle to the floor level where it will be detected. When this occurs, press reset button for 60 seconds to stop the alert.

Other combustibles, which will be detected, include alcohol, liquor, deodorants, colognes, perfumes, wine, adhesives, lacquer, kerosene, gasoline, glues, most cleaning agents and propellant of aerosol cans. Most are lighter than air in their vapor state and will only be detected when the motor home is closed up.

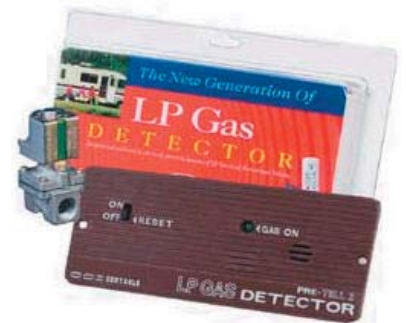

#### 1-1.3.1 Operation

Upon first application of power, the LED will flash yellow for three minutes, while the detector is stabilizing. At the end of the start cycle, the LED will turn Green, indicating full operation. If the detector senses unsafe levels of gas, it will immediately sound an alarm. The gas detector operates on 12 Volt DC, with a current draw less than 1/10th of one amp.

#### CAUTION!!

The detector will not alarm during the three minutes warm up cycle.

### 1-1.3.2 Alarm

The red LED will flash and the alarm will sound whenever a dangerous level of propane or methane gas is detected. The detector will continue to alarm until the gas clears or the TEST/MUTE switch is pressed.

### 1-1.3.3 Procedures to take during an alarm:

1. Turn off all gas appliances, (stove, heaters, furnace), extinguish all flames and smoking material. Evacuate, leave doors and windows open.
2. Turn off the propane tank valve.
3. Determine and repair the source of the leak. Seek professional help if necessary.

**CAUTION!!** Do not re-enter until the problem is corrected.

### 1-1.3.4 Fault Alarm:

Should the microprocessor sense a fault in the gas detector, a fault alarm will sound twice every 15 seconds. The LED will alternately flash red to green and the MUTE switch will not respond to any command. The gas detector must be repaired or replaced.

## 1-1.4 Carbon Monoxide Detector

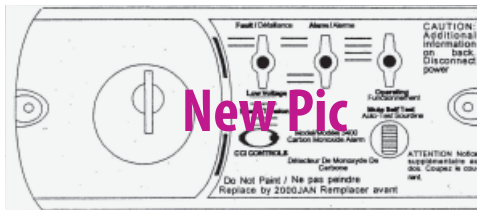

This motor home is equipped with a CCI Controls Carbon Monoxide detector. Carbon monoxide (CO) is a colorless, odorless and tasteless gas. Even low levels of CO have been known to cause brain and other vital organ damage in unborn infants, with no effect on the mother. In cases of mild exposure, the symptoms may include: a slight headache, drowsiness, confusion and fast heart rate. Extreme exposure can result in unconsciousness, convulsions, cardio-respiratory failure and death. Young children and household pets may be the first affected.

The CO detector is designed to detect the toxic CO fumes that result from vehicle exhaust and incomplete combustion sources like a furnace, gas stove or water heater. Consequently, it is uncommon for household smoke from cigarettes or normal cooking to cause the alarm to sound.

**NOTE:** Activation of this device indicates the presence of carbon monoxide (CO), which can be fatal. A concentration of above 100 PPM will cause a warning condition. Individuals with medical problems may consider using detection devices with lower carbon monoxide alarming capabilities. Prolonged exposure to the horn at a close distance may be harmful to your hearing.

### 1-1.4.1 Getting Started

These instructions include information on the installation, maintenance, and operation of the carbon monoxide (CO) alarm that is installed in your recreational vehicle (RV). It is important to keep these instructions in a handy location so you can refer to them as necessary. A properly installed and maintained CO alarm is an important part of your RV safety plan. Therefore, you and your family should read this manual thoroughly before operating your RV.

Your CO gas detector is operating at all times when it is connected to its power source. This detector will only operate when supplied with the stated operating voltage. This detector is a safety device. It must not be connected in such a way as to allow it to be switched off by the use of a wall switch or similar device, or to become disconnected from its power supply due to the use of a GFCI protected circuit. When the coach is equipped with an optional master cutoff switch for storage only, the detector will be turned off when this switch is turned OFF. This is acceptable as the coach is not to be used with the optional master cutoff switch in the off position.

In the event you have questions regarding the use of this CO alarm, call (800) 521-5228, Monday through Friday, 8 a.m. to 5 p.m. Pacific Standard Time. For the most current information visit the CCI website at: <http://www.ccicontrols.com>.

**WARNING!!**

**Actuation of your CO alarm indicates the presence of carbon monoxide (CO) which can KILL YOU.**

When the alarm sounds on this device and the RED Alarm Indicator light flashes, they indicate the presence of carbon monoxide (CO) which can be FATAL. The alarm will continue to sound until the carbon monoxide has dissipated or until the mute button is activated.

**If alarm sounds:**

1. Press the MUTE button.
2. Call for emergency services. (fire department 911)
3. Immediately move to fresh air outside or by an open door or window. Do a head count to check that all persons are accounted for. Do not re-enter the premises or move away from the open door or window until the emergency service personnel have arrived, the premises have been aired out, and your alarm returns to its normal condition.
4. After following steps 1-3, if your alarm reactivates within a 24 hour period, repeat steps 1-3 and call a qualified appliance technician.

Have the technician investigate for sources of CO from fuel burning equipment and appliances, and inspect for proper operation of this equipment. If problems are identified during this inspection have the equipment and appliances serviced immediately.

**NOTE:** Have technician inspect any combustion equipment or appliance and consult the manufacturer's instructions, or contact the manufacturers directly, for more information about CO safety of this equipment. Make sure that coach is not, and has not been, operating in an attached garage or adjacent to the residence.

**CAUTION!!**

This alarm will only indicate the presence of carbon monoxide (CO) gas at the sensor. CO gas may be present in other areas of the RV.

**1-1.4.2 Operation**

The CO alarm will only detect CO gas if the proper power is supplied. Once power is supplied (or re-supplied) to the alarm, it will perform a brief warm-up and self-check process before beginning to monitor for carbon monoxide gas.

**CAUTION!!**

This alarm will only indicate the presence of carbon monoxide gas at the sensor. Carbon monoxide gas may be present in other areas.

**1-1.4.3 CO Alarm Indicator Lights and Conditions**

**Power.** Once 12 volts DC power is supplied, the GREEN power indicator will turn on indicating the alarm is ready to detect CO gas.

**Alarm Condition.** When CO gas is present in alarm concentrations, an alarm will sound and the RED alarm indicator light will flash. The detector will continue to alarm until the CO gas has dissipated or until the MUTE button is momentarily pressed. If the MUTE button is pressed during an alarm condition, the alarm will stop sounding and the RED alarm indicator light will also stop flashing. If CO gas is still present in alarm concentrations, the alarm will resume within a few minutes depending on the concentration.

**Fault/Low Voltage.** In addition to sounding an alarm when CO gas reaches a specific concentration at the gas sensor, the CO alarm also performs two other valuable functions:

1. An automatic self diagnostic system check (called supervision) on the alarm's electronics to ensure reliable, trouble-free operation.
2. CO device acts as a low voltage indicator for the battery that supplies voltage to the alarm.

**Fault Condition.** In the event the CO alarm senses a fault in its electronics, the ORANGE Fault indicator light will illuminate continuously (not flashing) and then sound a beep once every five seconds. The GREEN power indicator will then turn off, indicating that the alarm is no longer monitoring for CO gas. If such action should occur, call CCI Controls for assistance during normal business hours. (8 a.m. to 5 p.m. PST).

**Low Voltage Condition.** This CO alarm has been designed to operate from a 12 volt DC power source. Without the correct voltage, the CO alarm may not detect carbon monoxide at the gas sensor. In the event that the CO alarm senses that a low voltage condition exists, the ORANGE Low Voltage indicator will illuminate continuously (not flashing) and then sound a beep once every sixty seconds. The GREEN Power indicator light will then turn off indicating that the alarm is no longer monitoring for CO gas.

In many instances, low voltage is an indication that the battery supplying voltage to the CO alarm needs recharging. If recharging your battery does not cause the ORANGE Low Voltage Indicator to turn off and the GREEN Power Indicator to turn on, call CCI Controls for assistance during normal business hours. (8 a.m. to 5 p.m. PST)

**NOTE:** Unlike the separate indicator lights for the GREEN power and the RED alarm, the Fault and Low Voltage conditions share the same ORANGE indicator light.

**Mute/Self-Test.** The Mute/Self-Test button serves two purposes: (1) to mute or silence the alarm and (2) to perform a self-test. See [Alarm Condition](#) above and [Testing Your CO Alarm](#).

### 1-1.4.4 Testing Your CO Alarm

**WARNING!!**  
 Test alarm operation after vehicle has been in storage, before each trip, and at least once per week during use.

It is important to test your CO alarm regularly.

To test the electronics of the CO alarm, press and release the test button. The alarm should sound a beep four times and the RED alarm indicator light will flash four times. In addition, the indicator lights are also tested. The GREEN power indicator light will turn off and the ORANGE Fault/Low Voltage indicator light will illuminate temporarily. If the CO alarm does not respond in this manner, then refer to the troubleshooting section.

### 1-1.4.5 Cleaning

Use a vacuum cleaner to remove dust or any other buildup on the detector. Do not wash. Wipe the detector with a damp cloth and dry it with a towel. Do not open the detector for cleaning. Do not paint the detector. It is recommended that the carbon monoxide detector be replaced every 10 years.

### 1-1.4.6 Troubleshooting

Description	Green Light	Red Light	Orange	Sounder	Resolution
<b>Normal Operation</b>	On	Off	Off	No Sound	
<b>CO Gas Detected</b>	On	Flashing	Off	Four Beeps then a pulse, every 5 seconds	Follow " <a href="#">What you should know if the CO alarm sounds</a> " section
<b>Low Battery Condition</b>	Off	Off	On	A single beep once every 60 seconds.	Recharge the vehicle battery.
<b>No Power</b>	Off	Off	Off	Off	You only have protection if the unit is powered.
<b>Fault Condition</b>	Off	Off	On	Beep Once every 5 seconds	Call CCI Controls
<b>Test Mode</b>	Dims off, then turns back on.	Flashes four times, then stops.	Dims on, then turns back off.	Four Beeps then a pulse, every 5 seconds.	Unit functional when Green light turns back on.

### 1-1.4.7 What You Should Know About Interaction with Other Products

Never ignore a CO alarm. A true alarm is an indication of potentially dangerous levels of carbon monoxide. This CO alarm is designed to provide an early warning signal to alert you to the presence of CO gas at the gas sensor. The alarm is designed to sound before most people will experience dangerous symptoms of CO poisoning. If you have special health conditions or medical problems, you should consider purchasing other warning devices which provide audible and visual signals for CO concentrations under 30 parts per million (PPM).

The glues, paints and other materials used in construction of new RV's and RV's that have been in storage often produce hydrocarbon vapors that may be detected. These hydrocarbon vapors may cause the alarm to sound. When this occurs, air out the RV.

In concentrated amounts, some common household products may cause the alarm to sound. These items could include alcohol, liquor, kerosene, gasoline, deodorants, colognes, and household cleaning products and aerosols. When this occurs, air out the RV and the CO alarm with fresh air.

#### 1-1.4.7.1 Sometimes the CO Alarm Will Sound Because Of:

- Simultaneous use of several fuel burning appliances competing for internal air.
- Negative air pressure resulting from the use of exhaust fans
- High outside wind causing CO to back up in the air vent pipes
- Vent pipe connections vibrating loose from clothes dryers, heaters or furnaces
- Obstructed vent pipes or unvented fuel burning appliances
- Temperature inversions which can trap exhaust gases near the ground.
- Car or RV idling nearby

**IMPORTANT NOTES:** Some products may prevent or delay your CO gas alarm from detecting carbon monoxide. Therefore, your CO gas alarm should not be:

- Installed too low where items such as water and other household chemicals can pollute the sensor
- Covered, obstructed or painted
- Exposed to sulfur products or powders of any kind

### 1-1.4.8 Technical Information

Sensor Level	70 ppm or more of carbon monoxide gas and before 10% carboxyhermoglobin (COHb) exposure level.
Operating	Green LED Illuminated
Alarm	Alarm will sound and red LED will flash.
Fault Condition	Orange LED illuminated. Alarm will beep every 5 seconds.
Low Voltage Condition	Orange LED illuminated. Alarm will beep every 60 seconds.
Audio Alarm	85dB at 10 Feet
Supply Voltage	12 volts DC nominal
Current Draw	50 milliamps maximum
Dimensions	3½ x 7 x 1-5/8 inches 8.89x17.78x4.12 cm
Storage Temperature	-40° F to 100° F -40° C to 37.8° C Humidity 95% max noncondensing
Operating Temperature	40° F to 100° F 4.4° C to 37.8° C Humidity 95% max noncondensing
Listing	Humidity 95% max noncondensing UL/CSA Listed

**Call (800) 521-5228 if you have any questions about your Carbon Monoxide Gas Alarm**

### 1-1.4.9 Limited Warranty

CCO Controls Warrants the equipment described hereon to be free from defects in material and workmanship under normal use and service when installed and used in accordance with all applicable state and local laws and regulations. CCI Controls sole obligation hereunder shall be limited to repairing or replacing the component or components shown to have been defective at time of shipment or to have become inoperative within the term of the warranty. This warranty does not cover transportation to and from the service locations, loss of time, inconvenience, commercial loss, loss of use, incidental changes, or other consequential damages. This warranty shall be for the term of two years from the date of the first sale by the dealer to the consumer. The consumer may be asked to produce the original sales contract or receipt to identify the date of purchase.

This CO gas alarm contains no user-serviceable parts. If you have questions as to servicing this alarm, contact CCI Controls. This warranty is voided if the alarm's casing is opened.

### 1-1.5 Fire Extinguisher

Your motor home is equipped with two Badger fire extinguishers. One located by the entrance door and the other by an outside bay. Please read the following operating instructions below before using your fire extinguisher. If there is any doubt on how to operate the fire extinguisher, you and your family should practice using it. Be sure to replace or recharge the extinguisher immediately after use.



#### 1-1.5.1 Basic Operation and Use

**In case of fire. . .**

1. Call the fire department
2. Get everyone out.
3. Plan your retreat.
4. The contents are discharged by pressure - DO NOT DISCHARGE AT A PERSON'S FACE - STAND A MINIMUM OF 6' to 10' FROM THE FIRE.
5. Hold the extinguisher firmly in an upright position.
6. Stay low to avoid inhalation of smoke and aim discharge just under the flames, using a side to side motion, sweeping the entire width of the fire. For wall fires, start at the bottom, sweep from side to side and progress upward. For floor fires, sweep side to side and move forward as fire diminishes to reach far edge of fire.
7. NEVER move into area where fire was burning even though it appears to have been extinguished. You could be trapped and burned if the fire reflash.
8. NEVER use water extinguishers on electrical fires.
9. NEVER use extinguishers at distances of less than 6 to 10 feet.

#### **Use the PASS word!**

**P**ull the pin to unlock the extinguisher

**A**im at the base (bottom) of the fire and stand 6-10 feet away.

**S**queeze the lever to discharge the agent.

**S**weep the spray from left to right until totally extinguished.

### 1-1.5.2 Inspection and Care

Be sure that the extinguisher is in its proper location so that there will be no delay in case of fire.

Your extinguisher should be checked once each month or more frequently if necessary to determine that:

1. The pointer on the pressure gauge is in the green operable area.
2. The nozzle opening has not been closed with some foreign object.
3. A ring pull is provided to prevent accidental discharge. This pin is secured by means of a plastic wire lock seal. On some models, the carry handle is sealed in place by a tape crossing over the lower portion. Check to make sure that the lock seal is intact. A broken lock seal is in indication of tampering and that there may have been a partial or total loss of contents.
4. Weigh the extinguisher at least every six months; and if below the weight designated under "Maintenance" on the extinguisher label, the extinguisher should be recharged.

### 1-1.5.3 Fire Classification Symbols

If your extinguisher bears these A, B or C symbols it can be used on the following fire types.



Ordinary Combustibles: Can be used on paper, cloth, wood, upholstery, and other ordinary combustibles.



Flammable Liquids: Can be used on gasoline, oil, grease, and other flammable liquids.



Electrical Equipment: Can be used on live electrical equipment.



Combustible Cooking Media: For use on cooking appliances that use combustible cooking media (vegetable or animal oils and fats).

FIRE EXTINGUISHER AND AGENTS		
TYPE EXTINGUISHER	BASIC AGENT	MAY BE USED ON
Regular (ordinary) Dry Chemical	Sodium Bicarbonate	
Multi-Purpose (ABC) Dry Chemical	Ammonium Phosphate	
Purple "K" Dry Chemical	Potassium Bicarbonate	
Carbon Dioxide	An Inert Gas	
Water	Tap Water	
Halotron 1	Vaporizing Liquid	
Wet Chemical	Potassium Acetate Solution	(WC-25)
		(WC-10)
		(WC-100 & WC-250)



## 1-1.6 Emergency Egress

An egress window is designated for use as an exit in the case of an emergency. Inside the motor home the egress is easily identified by the red locking handle. It is also marked as an "EXIT." Outside of the motor home, the egress window is identified by hinges along the top of the window. The glass slider in the egress window operates the same as all other windows. To open the egress window, lift the red handle and push outward on the window. Pull the window closed and lower the handles to lock the egress window.

### 1-1.6.1 Maintenance

The egress window should be opened twice a year to ensure proper operation. Over time, the rubber seal will tend to stick to the egress window. Occasional operation will help prevent the rubber seal from sticking.

## 1-1.7 Backup Alarm

Anytime motor home is in reverse a backup alarm will sound to warn that motor home is backing up. The alarm may be turned off by a switch on the dash marked Backup Alarm. A good reason to turn alarm off would be backing up a motor home into a spot in the early hours of the morning to avoid disturbing other residents.

## 1-1.8 Air/City Horns

Operate the horn by pressing on the center section of the wheel. Select air or city horn with the HORN SELECTOR switch on the dash. The air horn is a very loud horn much like the one on a semi-truck. The city horn is similar to your typical vehicle horn.

The air horn is a simple device, with limited parts, easy to adjust or repair. In most cases this can be done without removing or replacing the complete unit.

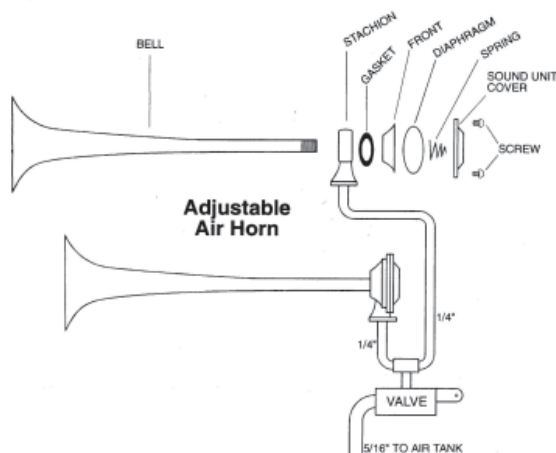

The Grover Product Line consists of two basic styles. There is the Adjustable model and Non-Adjustable model. These can be recognized by the mounting of the bell to the sound unit, examples below. The Adjustable models are all part numbers starting 10 in the four digit part number. The Non-Adjustable models start with 16, 17 and 20 in the four-digit number.

All Grover Air Horns are designed to operate at a minimum air pressure of 60psi and are factory tested at this pressure. The other main factor is the air volume, this is especially important in the 10 series dual mounted installation. By volume we are talking about the ability to pass enough air through a given line size. With dual 10s line size of at least 5/16" is required from tank to valve, from there through a tee 1/4" tube is OK. Kit #1098 Tubing, Fitting are recommended for large horns.



## Common Complaint

Air horn does not blow, or sounds weak. Assuming the plumbing is correct, we will check for tuning, when we refer to tune we are not talking about adjusting to high or low tone, it is in tune or out, blows weak or without the intensity you would expect from a air horn approximately 130db.

### Procedure:

To tune a horn, first check bushing threads exposed forward of sound unit should be one or two in most cases. To tune, hold bell end firmly with left hand and with right hand grasp complete sound unit and rotate counter clockwise slightly, only enough to turn bell, in or out to expose threads slightly forward of sound unit. A good starting point to tune is one thread exposed, tighten bell up to sound unit and try, if sound is not pronounced, loosen unit move slightly 1/8 turn in or out, and retry until sound is bright and crisp.

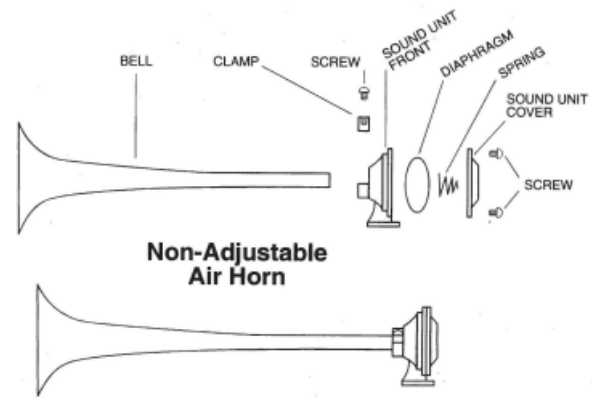

In some cases it becomes necessary to replace Spring, Diaphragm, or Gasket. Use Kit #1094.

On the Non-Adjustable style horns, Use Repair Kit #1681 for 1700 series and Kit #1607 for 1600 series horns. The only other item to check on these models, is the bell seating into the sound unit and tightness of clamp.

## 1-1.8.1 Backup Lights

Backup lights are similar to vehicle backup lights. They engage when the motor home is in reverse to warn motor home is backing up.

## 1-1.9 Landing Lights

There are three sets of landing lights. Two are on the left side of the motor home, two are on the right side of the motor home, and two are on the rear of the motor home. They may be switched on or off by selecting one of three buttons marked REAR LAND, LEFT LAND, or RIGHT LAND, on the panel just to the left of the main instrument panel on the dash. A common use would be to aid owner in various operations performed such as loading the motor home, entertaining, or anytime light is needed in that area of the motor home. The reverse landing lights will only operate while the motor home is in reverse or neutral. They will not operate if motor home is in drive.

## 1-1.10 Spot Lights

The spotlights are located on the roof in the front of the motor home. They are operated by and on/off switch and toggle switch used for directional purposes on the right hand side of the dash beside the ignition switch.

## 1-1.11 Vehicle Loading

The Federal Certification Label, located inside and above the driver's windshield between the sun visor mounting brackets describes the maximum weight-carrying capacities of your motor home and for each axle, respectively abbreviated by "GVWR" and "GAWR."

The Gross Vehicle Weight Rating (GVWR) is the maximum motor home weight allowable with all systems filled and with passengers and supplies aboard.

Each axle also has a maximum load-bearing capacity referred to as the Gross Axle Weight Rating (GAWR).

The load capacity is the difference between the GVWR and the actual weight. This means that the total weight of all food, clothing, other supplies and passengers must not permit the load capacity to be exceeded.

To find the actual weight, with the motor home fully loaded, drive to a scale, read the weight on the front, and rear wheels separately to determine axle loading. The load on each axle should not exceed its GAWR. If weight ratings are exceeded, move or remove items to bring all weights below the ratings.

When loading your motor home, store heavy gear first. Be sure to keep heavy gear on or as close to the floor as possible. Heavy items should be stored centrally to distribute the weight evenly between the front and the rear axles. Store only light objects on high shelves. Distribute weight to obtain even side-to-side balance of the loaded unit. Secure loose items to prevent weight shifts that could adversely affect the balance and road ability of the vehicle.

### 1-1.12.1 Motor Home Weight Information

Model \_\_\_\_\_

GVWR \_\_\_\_\_

UVW \_\_\_\_\_

NCC \_\_\_\_\_

GCWR \_\_\_\_\_

#### GVWR

(Gross Vehicle Weight Rating) means the maximum permissible weight of this motor home. The GVWR is equal to or greater than the sum of the Unloaded Vehicle Weight plus the Net Carrying Capacity.

#### UVW

(Unloaded Vehicle Weight) means the weight of this motor home as built at the factory with full fuel, engine oil, and coolants. The UVW does not include cargo, fresh water, LP gas, occupants, or dealer installed accessories.

#### NCC

(Net Carrying Capacity) means the maximum weight of all occupants including the driver, personal belongings, food, fresh water, LP gas, tools, tongue weight of towed vehicle, dealer installed accessories, etc., that can be carried by this motor home. (NCC is equal to or less than GVWR minus UVW).

#### GCWR

(Gross Combination Weight Rating) means the value specified by the motor home manufacturer as the maximum allowable loaded weight of this motor home with its towed trailer or towed vehicle.

This motor home is capable of carrying up to 100 gallons of fresh water (including water heater) for a total of 830 pounds. Reference: Weight of fresh water is 8.3 lbs./gal.; Weight of LP gas is 4.2 lbs./gal. (average).

 **NOTE: Consult weight decal located in motor home for actual weights.**

# 1-2 Security Features

## 1-2.1 Electric Compartment Locks

### 1-2.1.1 Entrance Door Dead Bolt Lock Operation

The entrance door has an automotive style two position catch. The second position is required for FMVSS certification. For maximum security and minimum wind noise be sure the door is fully closed. A dead bolt lock is also provided for your security; however, it will only engage and retract if the door is fully closed. Should you inadvertently open the automotive latch with the dead bolt engaged, you will have to shut the door to retract the dead bolt.

Dead bolt can be activated from switches located on the upper right hand dash panel; the entrance door systems control panel, and the bedroom control panel.

## 1-2.2 Black Widow Security System

The security system that is supplied with this coach is the Black Widow Security System. Basic operation directions for this system are as follows:

### 1-2.2.1 About Your Black Widow Security System

The security systems combine the benefits of easy-to-use convenience with “no nonsense” protection of person and property. Please review this manual to become familiar with your Black Widow vehicle security system. To operate your security system, the three principle components are first described: the Remote Control Transmitter, the Red Status Indicator Light, and the Easy Valet™ Switch.

### 1-2.2.2 Standard Features

The system has the following standard features:

- 5-button remote transmitter
- Status indicator (LED)
- Valet/Service mode switch
- Remote Start capabilities
- Extended Range Receiver
- Multi-tone siren (120 dB)
- Dual stage impact detector
- Remote panic
- Valet mode
- Remote chirp delete
- Remote sensor bypass
- Passive or active arming
- Stop and Go Feature
- Auto Cold Start
- Flashing Parking Lights
- Auto Rearm
- Passive/Active Arming
- Bay Door Release
- Rear Engine Door Release

### 1-2.2.3 Optional Features

This system has many optional features that may require additional parts and/or labor. Please contact your dealer for more details.

Remote keyless entry (Door lock/unlock)

- Illuminated entry
- LCD FM 2-way Remote
- Horn honk
- Window roll-up
- Back up battery
- Additional sensors: glass breakage/microwave

**NOTE:** Some features may not be appropriate for certain models. Automatic transmission and electronic fuel injection are required on models using this system.

### 1-2.2.4 Remote Transmitter Functions

**Button 1** Arms the system and locks the doors\*. Button 1 also activates the Panic feature.

**Button 2** Disarms the system and unlocks the doors\*.

**Button 3** Activates the Bay Door Release feature.

**Button 4** Activates the Remote Start Feature.

**Button 5** Auxiliary Shift Key.

**Button 5** then 4 Activates the 2nd auxiliary function.

### 1-2.2.5 Arming Operation

To arm the system press transmitter button 1:

- The siren will chirp once.
- The parking lights will flash once.
- The doors will lock\*.
- The LED will turn solid for 10 seconds then start flashing slowly, the system is now armed.

While the system is armed the alarm will trigger if:

- A door is opened.
- The bay door is opened.
- The shock sensor detects an impact to the vehicle.

When the alarm is triggered the siren will sound, the parking lights will flash, and the horn will honk\*. If the alarm is triggered while the remote start is engaged, the remote start will immediately shut down.

### 1-2.2.6 Passive Arming

The passive arming feature allows the system to arm automatically without user intervention. This programmable feature may be enabled during installation.

To arm the system passively:

1. Turn the ignition key off. †
2. Exit the vehicle and close all doors.
  - The LED will start flashing rapidly to indicate that the system is preparing to arm. (The system can be armed at any time by pressing transmitter button 1.)
  - The siren will chirp 30 seconds after the last door is closed to indicate the system is now armed.
  - The doors will lock ‡\*

\*Optional feature

† The ignition must have been on for at least 10 seconds prior to exiting the vehicle or Passive Arming will be bypassed.

‡ If the Passive Locking feature was enabled during installation.

### 1-2.2.7 Disarming Operation

To disarm the system press transmitter button 2.

- The siren will chirp twice ¥
- The parking lights will flash twice. ¥
- The doors will unlock. †
- The dome light will turn on for 30 seconds. \*

¥ if the siren was triggered while away, the system will respond with 3 chirps and 3 parking light features.

† If the Passenger Unlock Feature is enabled, pressing the unlock button will unlock only the driver's door. Pressing the unlock button again unlocks all doors.

### 1-2.2.8 Tamper Alert

If the alarm was triggered while away from the vehicle, the siren will chirp 3 times on disarming for tamper indication. After disarming the alarm, enter vehicle and turn ignition on. The LED will flash the zone that was triggered 5 times (see *LED chart*).

## 1-2-2.9 Auto Rearm

The Auto Rearm feature allows the system to automatically re-arm itself in the event the system is disarmed and ignition is not turned on within 30 seconds.

 **NOTE: This programmable feature may be disabled during installation. The Passive Arming feature and Auto Rearm feature are related. In order to disable the Auto Rearm feature, the Passive Arming feature must also be disabled during installation. This feature will not work on vehicles with the illuminated entry feature enabled.**

### 1-2.2.10 Silent Arming/Disarming

Press transmitter button 5 (the Shift Button) then the Arm or Disarm button for one-time silent operation.

### 1-2.2.11 Chirp Delete

For full time silent operation, the ARM/DISARM chirps can be permanently disabled. This feature must be programmed during installation.

### 1-2.2.12 Ignition Lock\*

The ignition locking feature allows the doors to automatically lock when the ignition key is turned on, and automatically unlock when the ignition key is turned off. This feature may be disabled during installation.

### 1-2.2.13 Remote Panic

In the event of an emergency (PANIC) situation, the system's siren can be triggered for 45 seconds to attract attention. To activate the Panic Feature, press transmitter button 1 for 3 seconds:

- The siren will sound.
- The parking lights will flash.

Press button 1 to exit panic mode and rearm the system. Press button 2 to exit panic mode and disarm the system. The Panic Feature will operate when the ignition is on.

### 1-2.2.14 Emergency Override

If the transmitter becomes lost or fails to operate, the system can be disarmed by using the emergency override feature.

To override the system:

1. Enter the vehicle.
  - Because the system is armed, the siren will sound.
2. Turn on the ignition key.
3. Press the Valet switch for 5 seconds.
  - The siren will stop sounding.
  - Starter defeat bypassed.

\*Optional feature

† The ignition must have been on for at least 10 seconds prior to exiting the vehicle or Passive Arming will be bypassed.

‡ If the Passive Locking feature was enabled during installation.

### 1-2.2.15 Valet Mode

When the system is placed in the Valet Mode the security system will be disabled. However, the optional keyless entry and remote start features will still function if installed.

 **NOTE: Remote Start feature may be disabled during valet mode if programmed during installation.**

**To enter the Valet Mode:**

1. Be sure the system is disarmed.
2. Turn the ignition key on.
3. Press and hold the valet/service mode switch for 3 seconds.
  - The siren will chirp once.
  - The LED will turn on solid indicating the system is in Valet Mode.

**To exit Valet Mode:**

1. Turn the ignition key on.
2. Press and hold the valet/service mode switch for 3 seconds.
  - The LED will turn off.
  - The Siren will chirp 2 times.

**1-2.2.16 Bay Door Release**

Press button 3 for approximately 2 seconds to open the bay door.

**1-2.2.17 Bay Door Disarm**

The Bay Door Disarm feature allows the alarm to disarm automatically whenever transmitter button 3 is used to activate the optional trunk release. This eliminates having to first, disarm the alarm before activating the bay door release.

 **NOTE: The feature is programmed during installation.**

**1-2.2.18 Remote Sensor Bypass**

To arm the system and bypass the shock sensor, press button 1 to arm, then within 2 seconds press button 2 again. The siren will chirp 5 times and sensors will be ignored until the system is disarmed and rearmed.

**1-2.2.19 Optional Secure Override Code**

If your system was programmed to override with a personal override code-pressing the override switch from 1 to 15 times.

To disarm the system with your personal override code please use the following steps:

1. Open Door, Alarm system will trigger
2. Turn ignition key to on.
3. Press the override switch to the selected number of times and hold on the last one for 5 seconds until the alarm turns off.

**1-2.2.20 Remote Starting the Motor Home**

**IMPORTANT: Only start the motor home in a well ventilated area. Do not use in a closed garage or indoors. Be sure to familiarize yourself with all features prior to using this product.**

*To remote start the motor home:*

Press the transmitter button 4 for 3 seconds.

- The parking lights turn on.
- Approximately 2 seconds later the system will attempt to start the motor home.
- Once the motor home has started, the heater or air conditioner will turn on and run for the pre-programmed time (15 or 25 minutes). If the engine fails to start on the first attempt, it will repeat the starting procedure 2 more times. If the vehicle fails to start after a total of 3 times the system will shut down.

**Driving motor home after Remote Starting:**

Unlock the door by pressing button 2 on the remote transmitter. Enter motor home, turn ignition key to the on position.

 **NOTE: Do not turn the key all the way to the start position as you may damage the starter.**

Once the ignition key is turned to the on position, press the brake pedal and shift the motor home into the proper gear and you may now drive the motor home.

 **NOTE: If brake pedal is pressed prior to turning on ignition, engine will turn off.**

**1-2.2.21 Remote Engine Shutdown**

If the motor home has been remotely started and you desire to turn the vehicle off, simply press and hold button 4 on the remote transmitter for three seconds. After the motor has turned off the doors will relock. This feature must be programmed during installation.

**1-2.2.22 Auto Cold Start**

This feature allows the system to start and run the motor home every one or two hours (selectable by the installer) for a period of 24 hours. This allows the engine to remain at an operational temperature in extremely cold weather. Auto Cold Start must be enabled during installation or it cannot be engaged.

**Engaging the Auto Cold Start feature:**

To turn Auto Cold Start on:

1. Press and hold the brake pedal.
2. While holding the brake pedal down, push the Valet switch and transmitter button 2 for two seconds.
  - The parking lights will flash four times to indicate the Cold Start feature is engaged.
3. Release the brake pedal.

**Disengaging the Auto Cold Start feature:**

The Auto Cold Start feature can be deactivated in one of three ways:

- Press the brake pedal.
- Turn on the ignition.
- Remote start the motor home using the transmitter.

**1-2.2.23 Stop and Go**

The Stop and Go features allows the motor home to remain running without use of the ignition key during short stops.

**To activate the Stop and Go feature:**

1. With engine running push transmitter button 4 (on FM 2-way press button 2).
  - The parking lights will turn on.
2. Remove the key from the ignition.
3. Exit the motor home and lock the doors manually or using transmitter button 1.

**To resume driver control:**

1. Unlock the doors manually or by pressing transmitter button 2.
2. Turn on the ignition.
  - The motor home resumes driver control.

### 1-2.2.24 Safety Features

The system will not start the motor home if the brake pedal is pressed. Also, if the brake pedal is pressed while remote running, the remote start will shut down.

### 1-2.2.25 Replacing Lost or Stolen Remote Transmitters

This system can “learn” a maximum of 4 remote transmitters. To add a transmitter or replace lost/stolen transmitters, please consult with an authorized dealer.

#### SYSTEM REFERENCE INDICATORS

##### STATUS INDICATOR (LED) FUNCTIONS

On Solid = Valet Mode  
 Slow Flash = System Armed  
 Rapid Flash = Passive Arming

##### TAMPER ALERT LED FUNCTIONS

1 Flash = Sensor #2  
 2 Flashes = Shock Sensor  
 4 Flashes = Door  
 5 Flashes = Bay Door  
 flash-flash-pause-flash-pause = Shock Sensor

##### PARKING LIGHTS FUNCTIONS

On Solid = Coach Remote Starting  
 Flash 1x = System Armed  
 Flash 2x = System Disarmed  
 Flash 3x = Tamper indication (after disarming)  
 Flash 4x = Defective zone warning (after arming)

### 1-2.2.26 Entering Programming

To enter System Programming:

1. Turn on ignition.
2. Within 5 seconds, press valet switch 5 times.
  - The siren will chirp 3 times, indicating that you have entered Programming.
3. Press the valet switch the number times equal to the Feature you want to change.
  - The siren will chirp each time the valet switch is pressed.
4. Within 5 seconds, press the transmitter button corresponding to the desired operating mode for that Feature.
  - The siren will chirp to indicate the setting.
    - One chirp = Button 1
    - Two chirps = Button 2
    - Three chirps = Button 3
5. Repeat steps 3 and 4 to change additional features.
6. Turn off ignition to save changes.



**NOTE: The optional FM transmitter may not be used for feature programming.**



<b>PROGRAMMABLE FEATURES</b>				
Step	Function	Button 1	Button 2	Button 3
1	Arming Mode	Active	Passive	
2	Auto Rearm	Off	On	
3	Normal/Silent Arming	Normal	Silent	
4	Ignition Locking	On	Off	Override Code Set
5	Ignition Locking	All Doors	Driver Only	Off
6	Door Unlock Pulse	Single	Double	
7	Door Lock Pulse Width	1 Second	3 Seconds	
8	Passive Locking	Off	On	
9	Entry Delay with Passive Arming	Off	On	
10	Bad Zone Report	5 Seconds	Off	
11	Auxiliary 2 Auto Activate on Arming	Off	On	
12	Auxiliary 1 Output	Momentary	10 Seconds Timed	Latched
13	Auxiliary 2 Output	Momentary	10 Seconds Timed	Latched
14	Bay Door Disarm Feature	Off	On	
15	Remote Start in Valet Mode (optional)	Enabled	Disabled	
16	Lock with Remote Start	On	Off	
17	Lock with Remote Shutdown	On	Off	
18	Engine Run Time	12 Minutes	24 Minutes	
19	Cold Temperature Starting	Every 2 hours	Every hour	
20	Engine Start Sense	Smart Start	Tach Start	
21	Engine Programming	Learn RPM	Gas Engine	Diesel Engine
22	FM Module Program (optional)	Learn Module	Learn FM Transmitter	
23	Ignition 2 Relay Programming	Ignition 2	Accessory 2	Starter 2
24	Horn Output	Horn Output	Ignition 3 Output	

### 1-2.2.27 Programmable Features

- 1. Arming Mode.** Select between manual arming (Active) or automatic arming (Passive).
- 2. Auto Rearm.** Automatically rearms the system in case of accidental disarming. The system must be armed for at least 10 seconds before disarming, and the bay door must not be opened or Auto Rearm will be bypassed.
- 3. Arming Chirps.** Select Normal or Silent Arming.
- 4. Ignition Locking / Override Code Set.** Automatically locks the doors when the ignition is turned on. The system will not lock the doors if any door is open with then ignition is turned on. Pressing Button 3 during this step enters the Override Code Set mode. Press the valet switch the desired number of times from 1-15 to set the code.
- 5. Ignition Unlocking.** Automatically unlocks the doors when the ignition is turned off. Select from all door unlock, driver's door only unlock, or no unlock.



**NOTE: Driver's door only unlock requires wiring the system for Passenger Unlock.**

- 6. Door Unlock Pulse – Single/Double.** Selects between a single pulse or a double pulse door unlock output.

- 7. Door Lock Pulse Width.** Selects between a 1-second and a 3-second output for motor homes equipped with vacuum door locking systems.
- 8. Passive Locking.** Selects whether or not the system will automatically lock the doors with Auto Rearm and Passive Arming.
- 9. Door Entry Delay with Passive Arming.** When selected, the door input trigger will be delayed for 15 seconds, allowing access to the emergency override switch. Only delays when the system is armed passively.
- 10. Bad Zone Report.** Siren will chirp 3 times if any zone remains open 5 seconds after arming. If motor home has delayed dome light, program this feature to OFF.
- 11. Auxiliary 2 Auto Activate on Arming.** When selected, the Auxiliary 2 output will pulse upon system arming to activate accessory items when the system is armed.
- 12. Auxiliary Function 1 –** Selectable for Momentary, Timed or Latched operation.  
When Momentary operation is selected, the system will provide an output for as long as the Transmitter button is held.  
When Latched operation is selected, the system will provide an output that turns on when the transmitter button is pressed and turns off when the transmitter button is pressed again.  
When Timed operation is selected, the system will provide an output that turns on for 10 seconds each time the transmitter button is pressed. If the button is pressed again during the 10 seconds, the output will turn off.
- 13. Auxiliary Function 2 –** Selectable for Momentary, Timed, or Latched operation.
- 14. Bay Door Disarm Feature.** When selected, activating the Auxiliary 1 function to open the bay door will automatically disarm the system.
- 15. Remote Start in Valet Mode.** Determines if the remote start feature will operate when the alarm is set for valet mode.
- 16. Lock with Remote Start.** Automatically locks the doors after successfully remote starting.
- 17. Lock with Remote Shutdown.** Automatically locks the doors 5 seconds after the remote start is shut down.
- 18. Engine Run Time.** Selects between 12 and 24 minutes run cycle.
- 19. Cold Temperature Starting.** Allows the vehicle to automatically start and run every 2 hours or every hour for severe cold weather.
- 20. Engine Start Sense.** Selects between Smart Start for tachless operation, or Tach Start for actual RPM monitored starting. (see Step #21)
- 21. Engine Programming.** Pressing transmitter button 1 “learns” the RPM. For diesel vehicles, after learning Tach signal enter step #21 again and set for diesel by pressing button 3.
- 22. FM Transmitter Module.** Pressing button 1 learns the add-on FM module ID so the FM transmitter can operate the system. Pressing button 2 learns the FM transmitter. After pressing button 2 on the AM remote, press transmitter button 1 on each FM remote (max 2).
- 23. Ignition 2 Relay Programming.** Selects between second ignition, second accessory, or second starter output operation for heavy gauge BROWN wire.
- 24. Horn Output.** Selects between horn output or ignition 3 output for the horn wire.

### Engine Programming for Remote Start

In order for the system to properly start and run the motor home, the unit must be able to determine if the motor home is cranking or if the engine is actually running. This system is equipped with two means of detecting the engine's run status: Smart Start and Tach Start.

The **Smart Start** feature detects the engine's run status using specially designed software that interprets certain characteristics of the engine, and does not require a connection to the motor home's tachometer wire. This feature allows a faster installation, but may not be compatible with all motor homes, or under extreme temperatures.

The **Tach Start** feature requires connection to the motor homes tachometer wire, or an injector wire if the tach wire is not available. The Tach Start feature provides reliable operation with virtually any vehicle and in severe temperature extremes. When the Tach Start feature is selected, the vehicle's tach signal must be "learned" through system programming. (see below)

### To Program the Tach Start feature:

1. Enter System Programming, (see Entering Programming)
2. Program Step #20 to Tach Start using transmitter button 2.
3. Re-enter system programming, and go to Step #21.
4. Immediately start the vehicle with the key to avoid the programming sequence timing out.
5. Press transmitter button 1 to learn the vehicle's tach signal.
  - The siren will chirp and the LED will flash once if the tach was learned.
  - The siren will chirp and the LED will flash 5 times if the tach was not learned.
6. Turn off ignition to save settings.

The default setting for the engine mode is Gas Engine. For diesel vehicles, the engine type for Step #21 must be set to Diesel Engine. When programmed for diesel engines, the BLUE/YELLOW wire (glow plug input) is monitored to make sure the glow plugs have warmed up before the engine begins cranking. If the glow plug wire is not connected, the unit has a built-in timer that waits 15 seconds before cranking the starter.

### Complete Default Reset

Following this procedure will set all User and Installer Programming Parameters to factory default settings.

1. Enter System Programming.
2. Press Transmitter Button 3.
  - The siren will chirp 6 times indicating the reset signal was received.
  - All Programming options are now set to factory default settings.
3. Turn ignition off.

### Test System and Adjust Shock Sensor

Arm, disarm, and start the system, checking that the siren and parking lights are functioning normally. Make sure that the programmed features are performing correctly, ie.: ignition locks, passive arming, passive locks, etc.

1. Test the doors and bay door inputs (make sure all doors trigger the system.)
2. Adjust the shock sensor. (see Real-time Sensor Adjustment Mode).
3. Arm the system and disarm it with the ignition and valet switch.
4. If programmed to passively arm make sure that the system arms properly.
5. Tie up wire harness, and replace any under dash panels.
6. Make sure the customer has physical knowledge of the location of the valet/override switch.

### Real-time Sensor Adjustment Mode

This mode allows active testing of the shock sensor and optional sensor input making adjustments without arming the alarm.

 **NOTE: Arm and Disarm chirps must be enabled for proper operation. Sensor Adjustment Mode does not operate with the optional FM transmitter.**

**To Enter Sensor Adjustment Mode:**

1. Turn the ignition on.
2. Press the Shift Button (Button 5) 3 times, then press Button 3.
  - The siren will chirp 4 times, indicating that the sensor is ready to be tested.
3. Test the sensitivity. The siren will chirp to indicate a sensor is triggered.
  - One chirp indicates the shock sensor.
  - Two chirps indicates the warn away.
  - Three chirps indicates the optional sensor.
4. To make shock sensor adjustments:
  - Turn the adjustment screw on the sensor clockwise to increase the sensitivity.
  - Turn the adjustment screw on the sensor counter clockwise to decrease the sensitivity.
5. Turn off the ignition when the desired sensitivity level is reached.

**Adding Transmitters**

To add a new transmitter to the system have the desired transmitters ready and follow the Code Learning sequence.

**To Enter Code Learning Mode:**

1. Turn the ignition on, off, on, off and leave on.
  - The siren will chirp.
2. Press the Override switch.
  - The status LED will turn on red.
  - The siren will chirp.
3. Press the Lock Button on the transmitter.
  - The siren will chirp once.
4. Press Lock Button on the transmitter again.
  - The siren will chirp twice.
5. Repeat steps 3 and 4 for each additional transmitter.
6. Turn off the ignition.
  - The siren will chirp 3 times.

### 1-2.3.28 Troubleshooting

Problem	Probable Cause	Suggested Correction
Alarm does not operate.	Alarm in Valet Mode; Ignition input has voltage on it; Missing +12V or ground.	Take alarm out of Valet Mode, Turn key off and verify yellow wire is connected to correct ignition wire; Check +12V and ground connections.
Alarm will not Passively Arm.	Unit is not programmed for Passive Arming, wrong polarity door input wire, Yellow ignition input has 12V+ on it.	Program step #1 for Passive Arming, Correct door switch polarity; Change Ignition input wire; make sure alarm is not in Valet.
Alarm will not enter Code Learning Mode.	Ignition was not left in the On position after turning it On and Off three times; Sequence not performed rapidly enough (5 sec.); Valet/Override Switch is defective or not plugged in.	Leave Ignition in On position; Repeat procedure quicker, Replace Valet Switch.
Alarm chirps 4 times 5 seconds after system is Armed.	Factory Dome Light Delay is longer than 5 seconds; Door open or defective pin switch; Shock sensor is not properly adjusted or defective.	If dome light delay is longer than 5 seconds program step #10 to OFF. Replace defective pin switch; Adjust or replace shock sensor.
Parking lights do not flash.	Wrong wire connected, Wrong polarity selected, or RED Wire #1 not connected to battery power.	Connect WHITE wire to proper wire, Reverse jumper polarity (see Jumper Settings), Connect RED wire #1 to +12V.
Door locks do not lock or unlock correctly, or action is reversed.	Defective GREEN or BLUE wire in door lock connector plug, GREEN and BLUE wires reversed, or wrong door lock wiring diagram used.	Check GREEN and BLUE wires on door lock connector plug; Verify vehicle's type of door lock system; Reverse wiring to door relays.
Illuminated Entry does not activate on upon disarm.	External relay required, or Wrong polarity wired for relay.	Add relay.
Range is poor.	Antenna wire is grounded; Module is picking up interference from coaches electrical system.	Make sure antenna is not connected to ground; Relocate module or route antenna away from computer modules.
Coach will not remote start.	Safety inputs are triggered.	Check Brake Switch input (+) or Bay Door Input (-).
Coach cranks and begins to run, then shuts off.	Smart Start is not compatible with this coach; Coaches tach signal is not learned.	Connect the BLACK/GRAY wire, and program the unit to learn the coaches tach signal.
Keyless entry does not operate with remote.	Wrong door lock polarity; Wrong lock wires connected.	See Bypassing Factory Theft Deterrent Systems.
Ignition triggered door lock feature does not operate.	Yellow wires shows +12V; Door is open; Door trigger input wrong polarity.	Connect yellow wire to proper ignition wire; Close door; Change door trigger polarity.
Coach horn honks when system disarmed and door is opened.	Coaches factory security system needs to be disarmed.	Locate the disarm wire (usually located in driver's kick panel) and connect VIOLET/WHITE wire to disarm factory system.
Coach will not start and alarm does not function properly.	Coach battery dead or drops below 9 volts when trying to start the coach.	Change or replace battery.

## 1-2.3 Entrance Door Air Lock

An air-operated lock is installed at the top of the entrance door for a tight seal. This lock engages automatically when the unit is put in drive after reaching 3 mph. This lock also disengages when unit drops below 3 mph. An override switch is located on the main dash panel. This keeps door locked all the time until the unlock switch is manually pushed.



## 2-1 Dash and Monitor Panels

This section is an overview of the Instrument and Control panels on your coach. Below you will find a illustration and an explanation for each button or dial that is installed in the coach. This is as it appears on a standard coach with all the standard options. Coaches purchased with different options may have a slightly different appearance.

### 2-1.1 Main Instrument Panel

Below is an photograph of the main instrument panel on the coach.

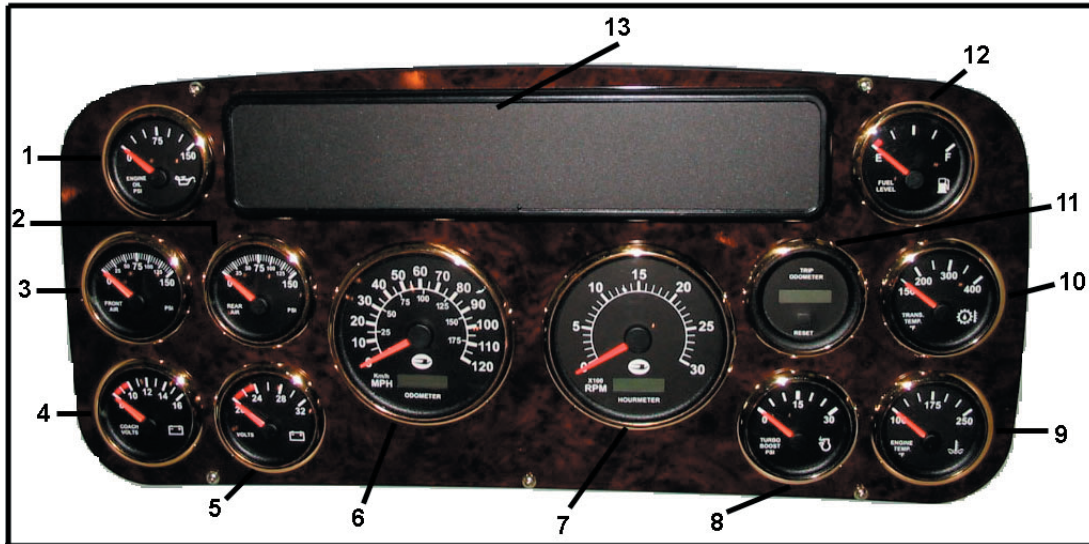

1. **ENGINE OIL GAUGE** - Gives constant reading of the engine oil in the supply line from the pump.
2. **REAR AIR GAUGE** - Normal: 110 to 135 psi. The Dual Air Service Brake Pressure systems are engine-operated and supply independent brake system air pressure for front and rear service brakes and the parking brake. During normal operation, each air pressure gauge reading will build up to 110 psi to 135 psi shortly after the engine is started.
3. **FRONT AIR GAUGE** - Normal: 110 to 135 psi. The Dual Air Service Brake Pressure systems are engine-operated and supply independent brake system air pressure for front and rear service brakes and the parking brake. During normal operation, each air pressure gauge reading will build up to 110 psi to 135 psi shortly after the engine is started.
4. **COACH VOLTAGE GAUGE** - Measures voltage of coach + 12v.
5. **VOLTAGE GAUGE** - Measures voltage on chassis +24 system.
6. **SPEEDOMETER IN MPH** - Measures miles per hour coach is traveling. Includes odometer.
7. **TACHOMETER IN RPM** - Measures engine revolutions per minute. Includes hourmeter which keeps track of how many actual hours engine has been used.
8. **TURBO BOOST PSI** - Registers the pressure of the Turbo Compressor outlet. This gauge should read an approximate maximum of 30 psi at maximum power.
9. **ENGINE TEMPERATURE GAUGE** - Monitors temperature of engine.
10. **TRANSMISSION TEMPERATURE GAUGE** - Indicates temperature of the transmission oil. If the WARNING LIGHT comes on, reduce speed or load.
11. **TRIP ODOMETER** - Allows user to track how long each trip is. This can be reset at any time to start counter over.
12. **FUEL GAUGE** - Indicates the amount of diesel fuel remaining in the fuel tank.
13. **TELLTALE PANEL** - Serves as a message center for the coach. See Telltale Panel section later in manual for further explanation.

## 2-1.2 Left Side of Main Instrument Panel Controls

Described below are the panel buttons that are found on the left side of the main instrument panel. All buttons are explained left to right. When top portion of button is depressed, the feature is engaged.



**HEADLIGHTS, PARK AND CLEARANCE LIGHTS** - Use this switch to select headlights, park and clearance lights.



**PARK AND CLEARANCE LIGHTS** - Use this switch to select your park and clearance lights only.



**FOG LAMPS** - Switches fog lamps on and off.



**REAR LAND** - Turns rear landing lights on/off.



**LEFT LAND** - Turns left landing lights on/off.



**RIGHT LAND** - Turns right landing lights on/off.



**CLEARANCE LIGHTS** - Turns clearance lights on and off.



**SUSP DUMP** - Switch for main suspension air. See Air Suspension System for operation.



**AIR/CITY HORN** - Allows user to toggle between the air and city horns. It is recommended the air horn be used for highway travel, and the city horn be used in residential areas.



**ENG BRAKE** - Enables the engine brake.



**BRK HI/LOW** - Selects HI or LOW if engine brake is engaged.



**TRACTION CONTROL** - Allows driver to select traction control in slippery or adverse weather conditions.



**HIGH IDLE** - When the engine is cold, the engine can be placed in the high idle state by turning on this switch.







## 2-1.3 Right Side of Main Instrument Panel Controls

Described below are the panel buttons that are found on the right side of the main instrument panel.



**120V AIR COMP** - This switch operates the auxiliary air compressor (*optional equipment*), which is a 120 vac operated back up air compressor.



**ENT AIR LOCK** - Enables entrance air lock. Locks door and overrides 3mph speed sensor.



**ENT DR LOCK** - Locks/unlocks entrance door.



**ENT STEP** - When switch is selected step is set to the EXTENDED position, with the ignition off, activates a relay locking the outside entry step in the EXTENDED position. When the ignition is turned on, the entry step automatically extends when the door is opened and automatically retracts when the door is closed. The indicator reminds you that your switch is in the ON position.



**RADAR** - Turns on power to the radar detector. The radar detector is a high-sensitivity super heterodyne microwave radar detector. This unit is designed to activate when transmissions are received from radar-type speed detection equipment.



**BAY LOCK/UNLOCK** - Locks/unlocks bay area.



**BRIGHT/DIM GAUGE** - This switch adjusts the gauge lights from bright to dim.



**GEN ON/OFF** - Turns Generator on and off.



**BATTERY CONNECT/BATTERY DISC** - This switch connects and disconnects the house and chassis batteries.



**ENG PRE HT** - This button is used to preheat the engine.



**CAMERA A/CAMERA B** - Camera A selects rear view. Camera B is available for future use.



**BACK UP** - Turns back up alarm on and off. Leave off when leaving RV park early in the morning. When top portion of switch is depressed, alarm is set to off.



**HAZARD FLASHERS** - Turns on emergency flashers. When the switch is used, both left and right turn signals will flash in unison.





**MIRROR HEAT** - This switch turns on a thermostatically controlled heater in the right and left outside mirrors (convex mirrors excluded). With the switch ON, the mirror heaters will automatically come on to defog the mirrors. Switch is shown in the off position.



**LEFT/RIGHT VISOR** - Use to raise/lower either left or right hand visor.



**FRONT A/C** - Turns front air conditioning on and off.



**KIT/BATH A/C** - Turns kitchen and bathroom air conditioning on and off.



**LIV RM A/C** - Turns living room air conditioning on and off.



**REAR A/C** - Turns rear air conditioning on and off.

## 2-1.4 Left Armrest Panel Transmission Gear Panel (under driver's window)

This panel is used to switch gears and modes in the transmission. The top box lights up to reflect which gear/mode is selected.

**R - Reverse** - Puts transmission in reverse.

**N - Neutral** - Transmission is in neutral.

**D - Drive** - Transmission is in drive.

**ECONOMY MODE** - Puts transmission in economy mode. This shifts transmission from 2000 to 1800 rpm which will save on fuel.

**ARROW UP** - Allows driver to shift up one gear at a time. For instance from 4th to 5th gear.

**ARROW DOWN** - Allows driver to shift down one gear at a time. For instance shifts from 5th to 4th gear.

**ARROW UP AND DOWN PUSHED TOGETHER** - When these are pushed at the same time the transmission will go into diagnostic mode. To use this feature the coach has to have the engine running, transmission must be at normal operating temperature. This mode will check the transmission fluid level and transmission defect codes. If this mode is selected and you have not met the conditions stated the system will let you know.



**HORN PWR** - Select to turn power on to horn.



**HORN SONG SEL** - This will allow user to select the song to play on the horn.



**HORN PLAY** - Select to play the horn.



**LEFT AND RIGHT OUTSIDE MIRRORS** - Use these controls to adjust outside mirrors as needed.

## 2-1.5 Leveling Panel

This panel controls the functions of the leveling system. Complete instructions on operating the leveling apparatus can be found in [Section 4-5 Leveling](#) found later in this manual.











## 2-1.6 Smart Wheel Controls

The steering wheel in the coach is a "Smart Wheel". Many functions can be performed from this wheel. The cruise control switches are located on the left hand side of the steering wheel and the windshield wiper functions are located on the right side of the steering wheel.

**HEADLAMP FLASH** - The button at the top left of the cruise panel flashes the headlights on and off.

The four buttons under the Headlamp Flash Button are for using the cruise control. These four buttons are explained below.

**NOTE:** The coach must be traveling at least 35 mph before the cruise control will operate properly.

-  **SET** - Use this button to set the cruise control to the desired cruising speed. Once engine is at desired speed press the button and hold momentarily and this will lock in that speed.
-  **RES** - This allows coach to resume cruising speed that was previously set when the off button was selected. If the brake was pushed down the cruise would be cancelled until this button has been pushed.
-  **ON OFF** - This turns cruise on and off.
-  **CANCEL** - Cancels all cruise control activity.
-  **CLEARANCE LIGHTS INTERRUPT** - This is the first button at the top on the right hand panel. Use this switch to turn off your clearance lights momentarily.
-  **OFF** - This turns windshield wipers off.
-  **HI-LO** - This controls two speeds at which the windshield wipers work, Hi or Lo.
-  **BOTTOM LEFT** - This switch is for the windshield washer fluid.
-  **BOTTOM RIGHT** - Is an intermittent switch. Use this when something other than HI-LO is needed. This regulates speed more accurately to allow for amount of moisture that is collecting on windshield. After off, press this switch once, wait the amount of delay you want in the wiper, and press the switch again. Wipers will continue to wipe at that delay.

## 2-1.7 Heat and Air Conditioning Dials

This panel is used to select the amount of heat and/or air conditioning that is needed, as well as defrost and fan.



## 2-1.8 Telltale Panel

The Telltale Panel shall contain the electronics necessary to interface to the vehicle system indicator inputs. This panel shall have a maximum of 34 indicators, which shall be arranged with two rows of eleven indicators located on the top and bottom separated by a single center row of twelve indicators. The turn signals shall be housed in the center row, outer indicator locations. Refer to the following tables for indicator source information. When the Indicator Bar is first powered on and sees the ignition signal, it shall run a lamp check on all lamps for a two second sound delay.

See Table 1 for details on signal source, audible alarm requirements, symbol or nomenclature, color function, and location on telltale panel.









Location	Indicator Lights	Signal Source	Audible Alarm	Symbol or Letters	Color	Function
1	Spare	N/A	-	SPARE	RED	SPARE
2	Spare	N/A	-	SPARE	RED	SPARE
3	Low Fuel	INSTR. ECU	-		AMBER	URNS ON IF < 1/8 TANK
4	Traction Control (ATC)	ABS	-	ATC	RED	URNS ON FOR DIAGNOSTICS, AND WHEN IN TRACTION CONTROL MODE
5	Park Brake	VEH	-		RED	URNS ON WHEN PARK BRAKE IS SET
6	Hi Beam	VEH	-		BLUE	URNS ON IF HI BEAM HEADLIGHTS ARE ON.
7	Stop Engine	ENGINE	BUZZER	STOP ENGINE	RED	URNS ON IF ENGINE FAULT
8	WAIT TO START (GRID HEATER)	ENGINE	-	WAIT TO START	RED	URNS ON WHEN ENGINE IS TURNING ON THE GRID HEATERS
9	ENGINE MAINTENANCE	ENGINE	-	ENGINE MAINT	AMBER	URNS ON IF ENGINE NEEDS MAINTENANCE
10	LOW COOLANT	VEH	BUZZER		AMBER	URNS ON IF COOLANT IS LOW
11	Spare	N/A	-	SPARE	RED	SPARE
12	LH TURN INDICATOR ARROW	VEH	CLICK		GREEN	URNS ON IF LEFT TURN SIGNAL HAS BEEN ACTIVATED
13	Spare	N/A	-	SPARE	RED	SPARE
14	WATER IN FILTER (RACOR)	VEH	See Note 1	WATER IN FILTER	AMBER	URNS ON IF WATER IN FUEL SENSOR DETECTS WATER
15	ABS	ABS	-		AMBER	URNS ON IF ABS SYSTEM HAS A FAULT OR DIAGNOSTIC INFORMATION
16	LOW AIR	PRX1	See Note 2	LOW AIR	RED	URNS ONIF AIR PRESSURE IS LESS THAN 62 PSI
17	ENGINE BRAKE	VEH	-	ENGINE BRAKE	RED	URNS ON IF ENGINE BRAKE DASH SWITCH IS ON
18	ENGINE COMPARTMENT (Fire) ALARM	VEH	See Note 3		RED	URNS ON IF ENGINE COMPT. FIRE SENSORS DETECT A FIRE
19	TRANSTEMP	TRANS	-	TRANS TEMP	RED	URNS ON IF TRANSMISSION FAULT

Table 1 - Telltale Panel Definitions

Table 1 - Telltale Panel Definitions - Continued from previous page

Location	Indicator Lights	Signal Source	Audible Alarm	Symbol or Letters	Color	Function
20	CHECK ENGINE	ENGINE	BUZZER (See Note 4)	CHECK ENGINE	AMBER	TURNS ON IF ENGINE DETECTS A PROBLEM
21	HYDRAULIC OIL TEMP WARNING	VEH	BUZZER		AMBER	TURNS ON IF HYDRAULIC OIL TEMPERATURE IS EXCESSIVE (>200°F)
22	Spare	N/A	-	SPARE	RED	SPARE
23	RH TURN INDICATOR ARROW	VEH	CLICK		GREEN	TURNS ON IF RIGHT TURN SIGNAL HAS BEEN ACTIVATED
24	DRL	VEH	-	DRL	GREEN	TURNS ON IF DAYTIME RUNNING LIGHTS ARE ON
25	Spare	N/A	-	SPARE	RED	SPARE
26	Spare	N/A	-	SPARE	AMBER	SPARE
27	HEADLIGHT ALERT	VEH	BUZZER		AMBER	TURNS ON IF HEADLIGHTS ARE LEFT ON BUT THE KEY IS OUT OF THE IGNITION
28	LEVEL WARNING	VEH	BUZZER	LEVEL WARNING	RED	NOT ON 45 FOOT VEHICLES
29	SUSPENSION DUMP	VEH	BUZZER	SUSP DUMP	RED	TURNS ON AFTER SUSP IS DUMPED (2 SEC. ON DELAY) TURNS BACK OFF (AFTER 1 MINUTE) AFTER SUSP. PRESSURE BACK UP
30	TAG DUMP	VEH	-		RED	NOT ON 45 FOOT VEHICLES
31	CHECK TRANS	TRANS	-	CHECK TRANS	AMBER	TURNS ON IF TRANSMISSION FAULT
32	TV ANT/SAFELINE	VEH	BUZZER (See Note 5)		FLASHING AMBER	TURNS ON IF SAFELINE PLUG IS LEFT PLUGGED IN AND IGNITION IS TURNED ON.
33	Spare	N/A	-	SPARE	RED	SPARE
34	Spare	N/A	-	SPARE	GREEN	SPARE

**Audible Outputs:** The Indicator bar shall have two audio transducers to produce the sounds listed in the table above. These sounds are identified as being a buzzer, a click, and a chime.

**Click:** The click output is used to indicate that the turn signals are flashing. Every time a turn signal indicator is turned on, the Buzzer output will be turned on for 10 ms.

**Single Chime:** The single chime output is used to indicate a Next Stop Request. The Indicator Bar will output 1.0 kHz for 1000 ms (including 800 ms of decay) when the Next Stop Request function is first activated, with a minimum sound pressure level of 85dB at 10cm.

**Double Chime:** The double chime output is used to indicate a Wheel Chair Next Stop Request. The Indicator Bar will output 1.0 kHz for 1000 ms (including 800ms of decay), then output 1.0 kHz for 1000 ms (including 800 ms of decay) when the Wheel Chair Next Stop Request function is first activated, with a minimum sound pressure level of 85dB at 10cm.

**Buzzer:** The buzzer output is the primary audible output. The Indicator Bar output 3.6 kHz +/- 0.5 kHz for as long as a buzzer function is activated, with a minimum sound pressure level of 90 dB at 10cm with 12 Volts applied.

**Buzzer Notes:**

**Note 1:** Water in Filter Buzzer. The Water in Filter (L14) input will activate the Buzzer during initial startup for a duration of 30 seconds, if the corresponding input was at ground when power was first applied.

**Note 2:** Low Air Buzzer. The buzzer and Low Air Indicator shall come on if the air pressure in EITHER front OR rear system has decreased to  $\leq 62 +2/-0$  PSI. Once the air pressure in EITHER front OR rear system falls below  $62 +2/-0$  PSI, the buzzer and indicator light shall remain on until the air pressure in BOTH front AND rear systems has reached a minimum of  $70 + 1/-1$  PSI.

**Note 3:** Engine Compartment Fire Alarm Buzzer. The Engine Compartment (Fire) Alarm (L18) input will activate the Buzzer at the rate of 2.0 Hz with a 50% duty cycle when the corresponding input is at +12 Volts.

**Note 4:** Stop and Check Engine (engine warning) Buzzer. The buzzer shall be continuously energized when either the stop engine OR check engine lamps are commanded by the engine AND critical limits are exceeded on EITHER the oil pressure data OR the coolant temperature data received off the data link. These limits shall be programmable. Default values for engine are in the following table:

**Table 2**

ENGINE	COOLANT TEMP	OIL PRESSURE
Deleted	Deleted	Deleted
C13	220	10

**Note 5:** TV/Safeline Buzzer. The TV/Safeline input will activate its indicator and the Buzzer at the rate of 1.0 Hz with a 50% duty cycle when the corresponding input is at ground.

**Priority Buzzer:** Priority shall be as follows with a priority 1 as the highest.

**Table 3**

BUZZER APPLICATION	PRIORITY
ENGINE COMPARTMENT FIRE ALARM	1
LOW AIR	2
ENGINE WARNING	3
TV / SAFELINE	4
WATER IN FILTER	5
TURN SIGNALS	7

**Indicator Signal Source:** See Table 4 for details on source for indicator light.

Table 4: 450 LXi Telltale Panel Signal Sources

FUNCTION					
	CUM	WT	BENDIX	PRX 1	VEHICLE
LOW OIL PRES ALARM				GND	
HIGH COOL TEMP ALARM				GND	
TRANS TEMP		GND			
CHECK TRANS		GND			
STOP ENGINE	GND				
CHECK ENGINE	GND				
ENGINE MAINTENANCE	GND				
WAIT TO START	GND				
LOW AIR				GND	
ABS			GND		
TRACT CONTROL (ATC)			GND		
PARK BRAKE					GND
RH TURN IND ARROW					+12V
LH TURN IND ARROW					+12V
HIHG BEAM					+12V
HYD OIL TEMP WARNING					GND
LOW COOLANT					GND
DRL					GND
ENG COMP FIRE ALARM					+12V
ENGINE BRAKE					GND
LOW FUEL				GND	
WATER IN FUEL					GND
WATER IN FILTER					GND
SUSPENSION DUMP					+12V
TAG DUMP					GND
LEVEL WARNING					+12V
HEADLIGHT ALERT					+12V
SPARE					GND
SPARE					GND
TV/ANT SAFELINE					GND

**Indicators that need to come on without Ignition On:** RH indicator, LH indicator, High Beam indicator, Level Warning indicator, Headlight Alert indicator, and Engine Compartment (fire) alarm indicator.

**Low Fuel Indicator:** This indicator input shall come from the PRX1 module, which will have special requirements. See the section on the PRX module.

**Power Up and Power Down Requirements:** Upon start up the indicator lights will turn on for a two second delay.

Table 5: Telltale Panel Pin Assignments

<b>450LXi</b>			
<b>SIGNAL NAME</b>	<b>PIN #</b>	<b>SIGNAL NAME</b>	<b>PIN #</b>
Spare Indicator	B1	DRL	B8
Spare Indicator	B4	Spare Indicator	C18
Low Fuel SIGNAL	A1	Spare Indicator	C19
Tract. Control (ATC)	A3	Headlight Alert (Not Used)	B12
Park Brake	C4	Level Warning (Not Used)	C2
High Beam	C15	Suspension Dump	C5
Stop Engine	C7	Tag Dump (not used)	C10
Wait To Start	A8	Check Trans	C11
Engine Maintenance	C16	TV Ant/Safeline	A4
Low Coolant	C9	Spare Indicator	C12
Spare Indicator	B3	Spare Indicator	C14
LH Turn Indicator	A18	Coolant Temp SIGNAL	A5
Spare Indicator	B3	Oil Pressure SIGNAL	A6
Water in Filter	B5	Spare Buzzer 4	A16
ABS	A2	Spare Buzzer 5	A17
Low Air	C1	Spare Buzzer 6	A15
Engine Brake	C3	Spare Buzzer 1	A14
Eng. Compartment (Fire) Alarm	C6	Spare Buzzer 2	A12
Trans Temp	C8	Spare Buzzer 3	A13
Check Engine	C17	Switched +12V	B6
Hydraulic Oil Temp Warning	C13	Ground	B7
Spare Indicator	B9	Spare Indicator	B10
RH Turn Indicator	C20		



## 2-2 Driver and Co-Pilot Area

### 2-2.1 CB Receiver Transmitter

Your motor home is equipped with a forty channel, CB receiver/transmitter installed in the lower left armrest with all controls in the hand held portion.



### 2-2.2 Closed Circuit Rear-Vision TV System

A color LCD rear view monitor is standard on the motor home. This allows you to see behind motor home. This is especially helpful when towing a vehicle, or backing up, allowing driver to see behind and keep an eye on what is in tow. Some features of this are:

- Wide Viewing Area (6.4" Diagonal)
- High Resolution (640 x 480)
- High Brightness (300 nit)
- Slimline Housing (1" Deep)
- Flat Rear Housing for easy Surface Mounting
- Automatic Video Signal Sensing for Turn-On Surface
- Designed and Tested for Automotive Use

#### Specifications:

Video Input System:	NTSC
Power Input:	12VDC; 850mA Current Draw
Video Input:	1V Peak to Peak Composite Video; 75 Ohm
Operating Temperature:	-10 °C to 60 °C
Storage Temperature:	-30 °C to 80 °C
Viewing Temperature:	6.4" Diagonal Measurement
Display Type:	Color TFT Active Matrix
Resolution:	640 x 480
Brightness	300 nit
View Angle Range (Left-Right)	±60°
View Angle Range (Top):	15°
View Angle Range (Down):	35°
Contrast Ratio:	120:1
Overall Dimensions:	5.22"(H) x 6.66" (W) x 1" (D)
Weight	16.0 oz.

### 2-2.2 Compass/Thermometer

The Compass/Thermometer is located in the center rear view mirror. There is also a thermometer located on the water tank monitor panel found in the pantry. Both thermometers measure outside ambient temperature in °F.



## 2-2.3 Remote Controlled, Heated Outside and Rear View Mirrors

Your motor home has two electronically adjustable heated mirrors. Each mirror has a flat mirror and a convex mirror. There are two switches, one that controls the left hand flat convex mirror and the other controls the right hand flat convex mirror. By flipping the switch from left to right this allows the driver to adjust the flat and convex mirrors separately.

Mirrors are electronically heated thermostatically controlled, designed not to overheat. Switches on the dash allow driver to turn heat on and off as desired.



Front View

Back View

## 2-2.4 Auto-Dimming Comp/Temp Mirror

The coach is supplied with a Gentex NVS® Auto-Dimming Comp/Temp Mirror. This mirror is equipped with the following features:

- Fully automatic electrochromic auto-dimming mirror
- Full range dimming - 75% to 6%
- Automatically disables dimming during daytime
- Digital compass with PathPoint™ continuous calibration software
- Outside temperature display
- Ice alert warning below 38°F
- Vacuum fluorescent display brightens and dims automatically

### Auto-Dimming Switch Function

- Hold Temp switch for 15 seconds to disable Auto Dimming and Auto LED will go off. Repeat step to enable Auto Dimming and the Auto LED will come on.

### Display Switch Functions

- Depress either the Comp or Temp switch to turn the display on/off.

### Zone Variation

This compass must be set to compensate for the variation between true north and magnetic north. To set variation:

- Turn ignition on.
- Using the map at right to find your geographic location, note the zone that you are in.
- To select Zone, push in the Comp switch for 3 seconds until the Zone selected comes up. Release, then toggle until correct zone is found and release switch. After 5 seconds of no switch activity, display will return to normal temperature reading.

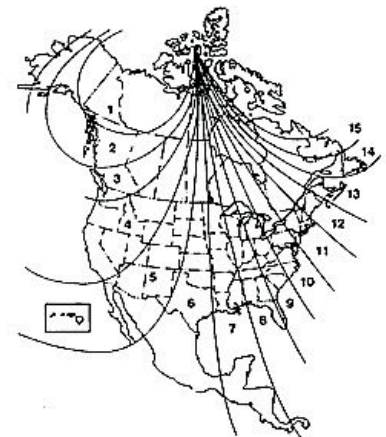

### Compass Calibration

This compass automatically calibrates itself while the vehicle is driven as your route takes you in complete circles. Therefore no calibration should be required, though it may take up to an hour. A quicker method is listed below. If the vehicle's compass headings become inaccurate, the compass can be manually calibrated by:

- Turn ignition on.
- Zone variation needs to be changed to use in different areas of the country.
- For a different Zone selection, push in the Comp switch for 3 seconds until the Zone selection comes up. Release, then toggle until correct zone is found and release switch.
- To re-calibrate, hold the Comp switch for 6 seconds until CAL is displayed. Drive the coach in at least 3 circles, allowing 45 seconds to complete one circle

### Temperature Function

- Push Temp switch for 3 seconds until display blinks °F or °C. Release, then toggle Temp switch to select between °F and °C. After 5 seconds of no switch activity, display will return to normal temperature reading.

### Ice Feature

Display will indicate “ICE” to alert driver of potential driving hazard when temperatures are below 38°F.

#### **WARNING!!**

**Do not locate a cellular antenna within 24” of the mirror.**

## 2-2.5 Entrance Door Electric Lock

The entrance door electric lock is operated by the right hand dash mounted switch that controls entry door locks.

## 2-2.6 Entrance Door Air Lock

The entrance door air lock is controlled by a signal generated by transmission which energizes the door air lock solenoid when motor home reaches 3 mph. There is also a switch located on the right hand dash panel which will override 3mph signal and lock the doors. When this switch is selected the motor home will not unlock automatically when it comes to a stop. Since this sound can be loud and annoying this feature will alleviate that problem when motor home is in stop-and-go traffic.

## 2-2.7 Six-Way Power Seats and Seat Belts

The seats in the motor home are Villa. They are mounted on a six way adjustable power and swivel base with electrically operated lumbar support. The seat is covered in Ultraleather.



## 3-1 Starting and Driving

### 3-1.1 General Information

The 450 LXi is equipped with a Caterpillar C13 Engine. The C13 engine is an in-line six cylinder arrangement. The engine has a bore of 130 mm (5.12 inch) and a stroke of 157 mm (6.18 inch). The displacement of the engine is 12.5 L (763 in3). Each cylinder has two inlet valves and two exhaust valves. The firing sequence of the engine is 1-5-3-6-2-4.

The engine has two turbochargers. The engine arranges the two turbochargers in a series. The two turbochargers allow the engine to have boost over the entire engine rpm range. The use of two turbochargers increases the maximum boost pressure to 310 kPa (45 psi). The engine also uses a precooler before the air-to-air aftercooler (ATAAC).

The Electronic Unit Injector (EUI) provides increased control of the timing and increased control of the fuel to air mixture. Engine speed is controlled by adjusting the injection duration. Engine timing is controlled by the precise control of fuel injection timing.

Modern electronic engines have the capability to perform self-diagnostic tests when the system detects an active problem, the operator will be alerted to the condition by the use of a check engine light and an event code will be stored in permanent memory in the Engine Control Module (ECM). Cat Electronic Technician ((ET) Caterpillar electronic service tool) can be connected to the engine in order to read any logged faults. Also, the cruise control switches and be used to flash the code on the check engine light. Intermittent faults are logged and stored in memory.

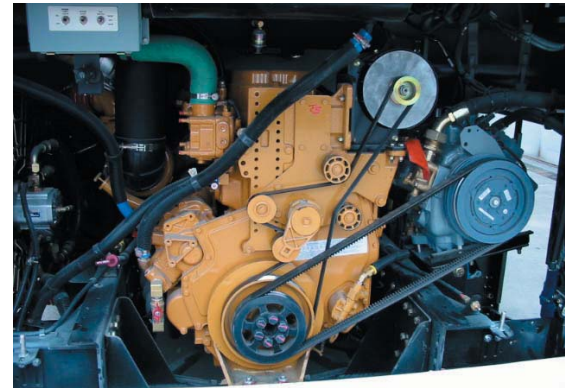

### 3-1.2 Starting the Engine

The engine's ECM will automatically provide the correct amount of fuel in order to start the engine. Do not hold the throttle down while the engine is cranking. If the engine fails to start in 30 seconds, release the starting switch. Allow the starting motor to cool for at least two minutes before attempting to use it again.

**NOTICE:** Excessive ether (starting fluid) can cause piston and ring damage. Use ether for cold weather starting purposes only.

#### 3-1.2.1 Cold Mode Operation

The ECM will set the cold start strategy when the coolant temperature is below 18°C (64°F).

When the cold start strategy is activated, low idle rpm will be increased to 1000 rpm and the engine's power will be limited until the engine reaches normal operation temperatures.

Cold mode operation will be deactivated when any of the following conditions have been met:

- Coolant temperature reaches 18°C (64°F).
- The engine has been running for fourteen minutes.

Cold mode operation varies the fuel injection amount for white smoke cleanup. Cold mode operation also varies the timing for white smoke cleanup. The engine operating temperature is usually reached before the walk-around inspection is completed. The engine will idle at the programmed low idle rpm in order to be put in gear.

**NOTICE:** Do not move the vehicle with the engine in the cold mode condition. Engine power could be noticeably reduced. At a vehicle speed above 8 km/h (5 mph), low idle rpm will be reduced to the customer programmed low idle and the power will still be reduced.

After the cold mode is completed, the engine should be operated at low rpm until normal operating temperature is reached. The engine will reach normal operating temperature faster when the engine is operated at low rpm and low power demand.

## 3-1.3 Remote Engine Starting

Because it may sometimes be necessary to start diesel engine remotely, a separate switch is located on the right side of the engine compartment. Toggle switch must be down (REAR) to start from the engine compartment. Engine will not start from front with rear engine door open. Front ignition key must be ON to start from rear.

## 3-1.4 Stopping Engine

**NOTICE:** Stopping the engine immediately after it has been working under load can result in overheating and accelerated wear of the engine components.

If the engine has been operating at high speed and/or high loads, run at low idle for at least three minutes to reduce and stabilize internal engine temperature before stopping the engine.

Avoiding hot engine shutdowns will increase turbocharger shaft and bearing life.

Prior to stopping an engine that is being operated at low loads, operate the engine at low idle for 30 seconds before stopping. If the engine has been operating at highway speeds and/or at high loads, operate the engine at low idle for at least three minutes. This procedure will cause the internal engine temperature to be reduced and stabilized.

Ensure that the engine stopping procedure is understood. Stop the engine according to the shutoff system on the vehicle.

- To stop the engine, turn the ignition key switch to the OFF position.

### 3-1.4.1 After Stopping the Engine

- Check the crankcase oil level. Maintain the oil level between the “ADD” mark and the “FULL” mark on the oil level gauge.
- If necessary, perform minor adjustments. Repair any leaks and tighten any loose bolts.
- Note the service hour meter reading. Perform the maintenance that is in the “Maintenance Interval Schedule” section of this manual.
- Fill the fuel tank in order to help prevent accumulation of moisture in the fuel. Do not overfill the fuel tank.

**NOTICE:** Only use antifreeze/coolant mixtures recommended in the Coolant Specifications of this manual. Failure to do so can cause engine damage.

- Allow the engine to cool. Check the coolant level. Maintain the cooling system at 13 mm (.5 inch) from the bottom of the pipe for filling.
- If freezing temperatures are expected, check the coolant for proper antifreeze protection. The cooling system must be protected against freezing to the lowest expected outside temperature. Add the proper coolant/water mixture, if necessary.
- Perform all required periodic maintenance on all driven equipment.

## 3-1.5 Cold Weather Operation

### 3-1.5.1 Radiator Restrictions

Caterpillar discourages the use of airflow restriction devices that are mounted in front of radiators. Airflow restriction can cause the following conditions:

- High exhaust temperatures
- Power loss
- Excessive fan usage
- Reduction in fuel economy

Shutters can be properly used for parking overnight, very cold temperatures, and high winds. In those particular cases, the coolant temperature and the inlet manifold temperature must be carefully monitored and controlled.

**NOTICE:** Failure to open the winter fronts in the morning could cause engine damage and/or loss of fuel economy.

### 3-1.5.2 Fuel and the Effect from Cold Weather

The following fuels are in the grades that are available for Caterpillar engines:

- No. 1
- No. 2
- Blend of No. 1 and No. 2

No. 2 diesel fuel is the most commonly used fuel. Either No. 1 diesel fuel or a blend of No. 1 and No. 2 is best suited for cold weather operation.

Quantities of No. 1 diesel fuel are limited. No. 1 diesel fuels are usually available during the months of the winter in the colder climates. During cold weather operation, if No. 1 diesel fuel is not available, use No. 2 diesel fuel, if necessary.

There are three major differences between No. 1 and No. 2 diesel fuel. No. 1 diesel fuel has the following properties:

- Lower cloud point
- Lower pour point
- Lower rating of BTU per unit volume of fuel

When No. 1 diesel fuel is used, a decrease in power and in fuel efficiency may be noticed. Other operating effects should not be experienced.

The cloud point is the temperature when a cloud of wax crystals begins to form in the fuel. These crystals can cause the fuel filters to plug. The pour point is the temperature when diesel fuel will thicken. The diesel fuel becomes more resistant to flow through fuel pumps and through fuel lines.

Be aware of these values when diesel fuel is purchased. Anticipate the average ambient temperature of the area that the engine will be operated. Engines that are fueled in one climate may not operate well if the engines are moved to another climate. Problems can result due to changes in temperature.

Before troubleshooting for low power or for poor performance in the winter, check the type of fuel that is being used.

When No. 2 diesel fuel is used the following components provide some means of minimizing problems in cold weather:

- Starting aids
- Engine oil pan heaters
- Engine coolant heaters
- Fuel heaters

### 3-1.5.3 Fuel Related Components in Cold Weather

#### Fuel Tanks

Condensation can form in partially filled fuel tanks. Top off the fuel tanks after operating the engine.

Fuel tanks should contain some provision for draining water and sediment from the bottom of the tanks. Some fuel tanks use supply pipes that allow water and sediment to settle below the end of the fuel supply pipe.

Some fuel tanks use supply lines that take fuel directly from the bottom of the tank. If the engine is equipped with this system, regular maintenance of the fuel system filter is important.

Drain the water and sediment from any fuel storage tank at the following intervals:

- Weekly
- Oil changes
- Refueling of the fuel tank

This will help prevent water and/or sediment from being pumped from the fuel storage tank and into the engine fuel tank.

#### Fuel Filters

A primary fuel filter and/or a water separator is installed between the fuel tank and the engine mounted fuel filter. The primary fuel filter and the fuel supply line are commonly affected by cold fuel. The primary fuel filter is mounted in the engine compartment. The primary fuel filter will benefit from the radiant heat of the engine.

#### Fuel Heaters

Fuel heaters help to prevent fuel filters from plugging in cold weather due to waxing. If coach is going to be driven extensively in cold weather a fuel heater may want to be considered. If a fuel heater is purchased it should be installed so that the fuel is heated before the fuel enters the primary fuel filter.

To select a fuel heater, contact your Caterpillar dealer.

The following fuel heaters are recommended for use with Caterpillar engines:

- 7C-3557 Fuel Heater Group
- 7C-3558 Heater Kit

Your Caterpillar dealer can give you full information on the benefits of fuel heaters and which type would be best for you.

## 3-1.6 Adding Antifreeze

### 3-1.6.1 Adding Shell Heavy Duty Extended Life Antifreeze

The 450LXi comes with KOSTGard Pre-Charged Antifreeze made especially for Blue Bird Corporation. Kost does not recommend that Shell's Heavy Duty Extended Life Antifreeze be added to this solution. Though it will not cause any permanent damage, it will cause maintenance to be done more frequently. The KOST USA product is formulated with a conventional additive system that is less aggressive when reacting with the components of the cooling system. The Shell Extended Life product is made with an organic acid technology based additive system. These two additive systems will not create a major problem in the cooling system when mixed together, but they do not particularly like each other and essentially revert to the lowest common denominator, which would be approximately a 30,000 mile coolant.

If you do choose to mix these two technologies together Kost recommends servicing the cooling system at this 30,000 mile interval which includes draining and refilling the cooling system.

### 3-1.6.2 Acceptable Products

Any conventional type antifreeze that is low in silicates and is phosphate free would be suitable to mix with the KOSTGuard Pre-Charged Antifreeze. Some of these products include:

- Fleet Charge - by Old World
- Zerex Pre-Charged - by Valvoline
- Shell Diesel Ready with SCA's added - by Shell



## 3-2 Towing

### 3-2.1 Receiver Type Trailer Hitch

This is a 10,000 pounds rated capacity and 1,000 pounds tongue weight capacity receiver type hitch.

When using the rear hitch remember that the motorhome is intended for towing light loads. Your motorhome is designed to be used primarily as a recreational vehicle, towing will affect durability and economy. Your safety and satisfaction depends on proper use. Avoid excessive loads. Do not use the motorhome to tow anything until it has been driven 500 miles (800 kilometers). Weight pushing down on the rear hitch must not exceed 1,000 pounds. We recommend weighing your motorhome, as it will be operated, to be certain that there is proper weight distribution. When weighing the motorhome be sure to take the passenger locations into consideration. Total weight of your motorhome and any vehicle towed by it must not exceed the GCWR.

#### WARNING!!

**Any trailer being towed by your motorhome must have adequate brakes. Failure to follow these instructions will create a safety hazard and may result in an accident.**

### 3-2.2 Tow Hooks

Two tow eyes are located at the front of the motorhome. Removable tow hooks are provided. Insert hooks into receivers and secure with pins provided.



**NOTE: If towing a vehicle from tow hooks generator access panel must be removed prior to towing.**

#### WARNING!!

**DO NOT LIFT MOTORHOME WITH TOW EYES. TOW EYES ARE FOR FLAT GROUND MANEUVERING ONLY.**

## 3-2.3 Having Your Motorhome Towed

### 3-2.3.1 Towing Procedures

It is recommended that if a towing company is called make sure they use a wheel grid (an arm that goes under motorhome and lifts from the front tires.) *Refer to figures 1 and 2* below.



Figure 1



Figure 2

The towing company may need to locate the air valve (see fig. 3) to release the air brakes. The air fitting is located in the front electrical compartment and should only be used by towing or service personnel. If the motorhome ever needs to be towed, use the following instructions:

- Secure any loose or protruding parts if the motorhome is damaged.
- Inspect points of attachment on a disabled motorhome. If attachment points are damaged, select other attachment points at a substantial frame structural member.
- Never allow anyone to go under a motorhome while it is being lifted by towing equipment unless the disabled motorhome is adequately supported by safety stands.
- Do not lift the motorhome from the rear. Lifting from the rear will cause the front tires and suspension to be seriously overloaded, possibly resulting in a tire or front suspension failure. Rear frame extensions are not designed to withstand loads imposed by lifting the rear of the motorhome. Flat towing of motorhome from rear is acceptable.
- If rear wheels are disabled, place the motorhome on a flat bed trailer or use a heavy-duty dolly under the rear wheels and tow from the front of the motorhome.
- The drive shaft must be removed to protect transmission.



Air Fitting

Figure 3

**WARNING!!**

**In the event the motorhome requires towing ensure all precautions are followed. The drive-line must be disconnected and the mud flap may need to be removed. Blue Bird Coachworks will not cover damage to the motorhome caused by a towing company.**

**3-2.3.2 Disabling the Parking Brake**

**Block wheels securely before attempting this procedure.**

- Remove the plug from the center of drive and tag axle brake cans. (see fig. 4)
- Use a wrench to tighten the bolt, which compresses the internal spring, releasing the brake.
- Repeat for the other brake cans.
- After towing, or when air pressure is again available, loosen the bolt and replace plug.
- Repeat for the other brake cans.



Figure 4

**WARNING!!**

**Do not attempt to disassemble brake canisters without special tools and without having studied specific manufacturer's instructions. Canisters contain springs under very high tension. Improper handling could result in component damage or personal injury.**

### 3-2.3.3 Towing With a Wheel Grid (Front End Only)

Make sure the tow truck can safely handle the weight of the motorhome. Give the towing company the weight of your motorhome when you call. If your motorhome is going to be towed with a wheel grid do the following:

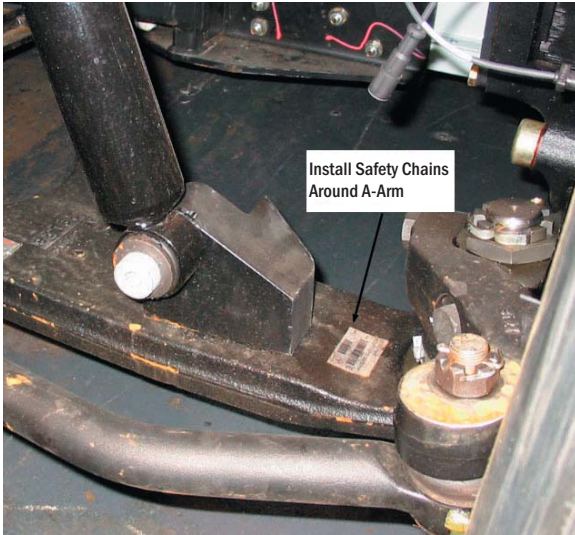

Figure 5 - Front Axle

- Maneuver wheel grid into position. After motorhome has been lifted, install safety chains on lower A-arms. (See Fig. 5)
- Attach safety chains, which are completely independent of the primary lifting device, to the tow eyes.
- When the motorhome is under tow allow enough room between the front of the motorhome and the rear of the tow vehicle while turning corners.



## 4-1 Interior/Exterior Storage

### 4-1.1 Interior Storage

Your coach comes equipped with the finest cabinets. There is storage located in cabinets, closets and under the bed, except for slide-out cross-island beds (see note below).

#### 4-1.1.1 Cabinets

Cabinets in the coach have positive latches. This keeps them closed when moving designed to keep things inside when in over-the-road-use. What this means is a little force needs to be used when opening them up.

#### 4-1.1.2 Cleaning Cabinets

The motor coach are finished with a high quality nitro-cellulose lacquer. Select a non-alcohol based cleaner for cleaning cabinets. Cleaners recommended for cleaning cabinets are Pledge, Endust, etc.

**IMPORTANT: Do not use any alcohol based cleaners. They will dull and strip the finish of the wood.**

#### 4-1.1.3 Closets

At least one full-length hanging closet is standard in each floor plan. A 12 VDC light fixture in the ceiling of the closet is standard. Closet lighting is automatic when swinging doors are opened. Swinging doors provide access. Sliding doors in bedroom closets have manually switched lights.

#### 4-1.1.4 Under Bed

The Wanderlodge 450 LXi island bed provides storage underneath the bed. This storage is accessed with the assistance of gas cylinders. This area is carpeted with the floor carpet selected for the remainder of the bedroom.

**NOTE: Slide-out cross-island beds do not have storage underneath due to the slide-out mechanism.**

#### 4-1.1.5 Accessing Under Bed Storage

Under bed storage area in island beds is accessed by a hinged bed board. Gas cylinders are installed on bed board for easy operation. Storage area is carpeted using floor carpet selected per each interior.

#### 4-1.1.6 Overhead Cabinet

A full-length overhead cabinet is installed over the head of the bed.



### 4-1.6 Dinette Cabinets

Cabinets are installed over the dining area. These cabinets are made of a laminate surface with a 5/8" lite plywood solid core substrate.

To clean these cabinets, wipe off with warm water. Cabinets may be cleaned with any non-abrasive, non-volatile cleaner.

## 4-1.2 Exterior Storage

### 4-1.2.1 Cargo Bays

The 450 LXi has exterior storage in compartments below the coach called cargo bays (basement). There are four cargo bays located beneath the coach. The bays are constructed of ridged stainless steel to control slipping of personal items.



Cargo Bays Closed

Cargo Bays #1, #2 and most of #3 are left empty for storage use.



Cargo Bays Open



Cargo Bay #3 - Curbside

**Cargo Bay #3 - Curbside** - This is mostly used for storage with a small portion housing the Webasto Hydronic Heating System. For a full explanation of this system as well as the uses and benefits refer to Section 4-8 Heating Systems found later in this manual.

**Cargo Bay #4** houses the gray and black tanks, water systems and the outside water and air hookups. As well as switches for:

- Fresh Tank Fill
- Water Hose Reel
- Black Dump Valve
- Left Porch Light
- Panel Lights Master
- Water Pump
- Gray Dump Valve
- RS Land Lights



Bay 4 - Roadside



Bay 3 - Inverter

Bay 3 also houses the Vanner inverter. The inverter has the ability to pull power out of 12-volt batteries and convert it to 120 VAC to run appliances. It can also pull 120 VAC power and convert it to 12 volt as needed. A full explanation on how this device is used can be found in Section 4-3 Inverter later in this manual.





## 4-2 PowerTech PTSMH20.0 Generator

A PowerTech PTSMH20.0 Generator is supplied with the 450 LXi Coach. This is located in the front of the coach under the windshield area. The area can be extended out by pushing the “out” button located under the driver’s panel inside the coach. See Instruments and Controls section for more details. This allows for easy access for repairs and maintenance procedures. Pushing the “in” button will push the generator back in the coach.



### 4-2.1 Safety Precautions

Careful operation is your best insurance against an accident. Read and understand this entire section carefully before operating the generator engine. All operators, no matter how much experience they may have had, should read this and other related manuals before operating the engine or any equipment attached to it. It is the owner’s obligation to instruct all operators in safe operation.

#### 4-2.1.1 Observe Safety Instructions

- Read and understand carefully this “Operator’s Manual” and “Labels on the Engine” before attempting to start and operate the engine.
- Learn how to operate and work safely. Know your equipment and its limitations. Always keep the engine in good running condition.
- Before allowing other people to use engine, explain how to operate and have them read this manual before operation.
- Do not modify the engine by yourself. Unauthorized modifications to the engine may impair the function and/or safety and affect engine life.

#### 4-2.1.2 Wear Safety Clothing

- Do not wear loose, torn or bulky clothing around the machine that may catch on working controls and projections causing personal injury.
- Use additional safety items, e.g. hard hat, safety protection, gloves, etc., as appropriate or required.
- Do not operate machine or any equipment attached to it while under the influence of alcohol, medication, or other drugs, or while fatigued.
- Do not wear radio or music headphones while operating engine.

#### 4-2.1.3 Check Before Operating and Starting the Engine

- Be sure to check the engine before operation. If something is wrong with the engine, do not fail to repair it quickly.
- Keep all guards and shields in place before operating the engine. Replace any that are damaged or missing.
- Check to see if there is a safe distance from the engine before starting.
- Always keep the engine at least 3 feet (1 meter) away from buildings and other facilities.
- DO NOT allow children or livestock to approach the machine while the engine is running.
- DO NOT start the engine by shorting across starter terminals. The machine may start.

#### 4-2.1.4 Keep Area Around the Engine Clean

- Be sure to stop the engine before cleaning.
- Keep the engine clean and free of accumulated dirt, grease and trash to avoid a fire. Store flammable fluids away from sparks and fire.
- Keep the engine idling for about 5 minutes or over before stopping. Temperatures around the engine rise suddenly.

### 4-2.1.5 Safe Handling of Fuel and Lubricants

- Always stop the engine before refueling or/and lubricating.
- DO NOT smoke or allow flames or sparks in your working area. Fuel is extremely flammable and explosive under certain conditions.
- Refuel at a well ventilated and open place. When fuel and lubricants are spilled, refuel after letting engine cool off.
- DO NOT mix gasoline or alcohol with diesel fuel. The mixture can cause a fire.

### 4-2.1.6 Exhaust Gases & Fire Prevention

- Engine exhaust fumes can be very harmful if allowed to accumulate. Be sure to run the engine in a well ventilated place and where there are no people or livestock near the engine.
- The exhaust gas from the muffler is very hot. To prevent a fire, do not expose dry grass, mowed grass, oil and any other combustible materials to exhaust gas. Also, keep the engine and muffler clean all the time.
- To avoid a fire, be alert for leaks of flammables from hoses and lines. Be sure to check for leaks from hoses or pipes, such as fuel and hydraulic by following the maintenance check list.
- To avoid a fire, do not short across power cables and wires. Check to see that all power cables and wirings are in good condition. Keep all power connections clean. Bare wire or frayed insulation can cause a dangerous electrical shock and personal injury.

### 4-2.1.7 Escaping Fluid

- Relieve all pressure in the air, the oil and the cooling systems before any lines, fittings or related items are removed or disconnected.
- Be alert for possible pressure when disconnecting any device from a system that utilizes pressure. DO NOT check for pressure leaks with your hand. High pressure oil or fuel can cause personal injury.
- Escaping hydraulic fluid under pressure has sufficient force to penetrate skin causing serious personal injury.
- Fluid escaping from pinholes may be invisible. Use a piece of cardboard or wood to search for suspected leaks: do not use hands and body. Use safety goggles or other eye protection, when checking for leaks.
- If injured by escaping fluid, see a medical doctor immediately. This fluid can produce gangrene or severe allergic reactions

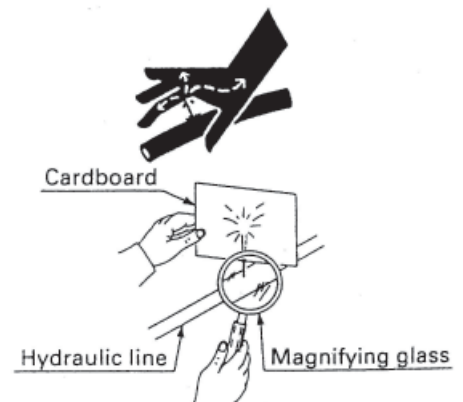

### 4-2.1.8 Cautions Against Burns and Battery Explosion

- To avoid burns, be alert for hot components, e.g. muffler, muffler cover, radiator, pipes, engine body, coolants, engine oil, etc. during operation and just after the engine has been shut off.
- DO NOT remove the radiator cap while the engine is running or immediately after stopping. Otherwise hot water will spout out from radiator. Wait for more than ten minutes to cool the radiator, before removing the cap.
- Make sure to shut the drain valve off coolant and close oil pressure cap, and to hand fasten pipe before operating. If those parts are taken off, or loosened, it will result in serious personal injury.
- The battery presents an explosive hazard. When the battery is being activated, hydrogen and oxygen gases are extremely explosive.
- Keep sparks and open flames away from the battery, especially when charging the battery. DO NOT strike a match near the battery.
- DO NOT check battery charge by placing a metal object across the terminals. Use a voltmeter or hydrometer.
- DO NOT charge battery if frozen. It can be explosive. When frozen, warm the battery up more than 16°C (61°F).

### 4-2-1.9 Keep Hands and Body Away From the Rotating Parts

- Be sure to stop the engine before checking or adjusting belt tension and cooling fan.
- Keep your hands and body away from any rotating parts, such as cooling fan, V-belt, fan drive V-belt pulley or flywheel to avoid causing personal injury.
- DO NOT run the engine with installed safety guards detached. Install safety guards securely during operation.

### 4-2.1.10 Anti-Freeze and Disposal of Fluids

- Anti-freeze contains poison. Wear rubber gloves to avoid personal injury. In case of contact with skin, wash it off immediately.
- DO NOT mix different types of anti-freeze. The mixture can produce a chemical reaction causing harmful substances. Use approved or genuine KUBOTA anti-freeze.
- Be mindful of the environment and the ecology. Before draining any fluids, find out the correct way of disposing of them. Observe the relevant environmental protection regulations when disposing of oil, fuel, coolant, brake fluid, filters and batteries.
- When draining fluids from the engine, place a container underneath the engine body.
- DO NOT pour waste onto the ground, down a drain, or into any water source.

### 4-2.1.11 Conducting Safety Checks and Maintenance

- When checking engine or servicing, place the engine on a wide and level ground. DO NOT work on anything that is supported ONLY by lift jacks or a hoist. Always use blocks or correct stands to support the engine before servicing.
- Detach the battery from the engine before conducting service. Put a "DO NOT OPERATE" tag in the key switch to avoid accidental starting.
- To avoid sparks from an accidental short circuit always disconnect the battery's ground cable first and connect it last.
- Be sure to stop the engine and remove the key when conducting daily and periodic maintenance, servicing and cleaning.
- Check or conduct maintenance after the engine, coolant, muffler, or muffler cover, have been cooled off completely.
- Always use the appropriate tools and jig-figure in good condition when performing any service work. Make sure you understand how to use them before service.
- Use ONLY correct engine barring techniques for manually rotating the engine. DO NOT attempt to rotate the engine by pulling or prying on the cooling fan and V-belt. This practice can cause serious personal injury or premature machine damage to the cooling fan.
- Replace fuel pipes and lubricant pipes with their hose clamps every 2 years or earlier whether they are damaged or not. They are made of rubber and are aged gradually.
- When service is performed together by two or more people, take care to perform all work safely.
- Keep first aid kit and fire extinguisher handy at all times.

### 4-2.1.11 Warning and Caution Labels



### 4-2.1.12 Care of Warning and Caution Labels

1. Keep warning and caution labels clean and free from obstructing material.
2. Clean warning and caution labels with soap and water, dry with a soft cloth.
3. Replace damaged or missing warning and caution labels with new labels from your local KUBOTA dealer.
4. If a component with warning and caution label(s) affixed is replaced with new part, make sure new label(s) is (are) attached in the same location(s) as the replaced component.
5. Mount new warning and caution labels by applying on a clean dry surface and pressing any bubbles to outside edge.

## 4-2.2 Pre-Operation Check

### 4-2.2.1 Break-In

1. During the engine break-in period, by all means, observe the following:  
Change engine oil and oil filter cartridge after the first 50 hours of operation (See “Engine Oil” in Periodic Service Section).
2. When ambient temperature is low, operate the machine after the engine has been completely warmed up.

### 4-2.2.2 Daily Check

To prevent trouble from occurring, it is important to know the conditions of the engine well. Check it before starting.

**CAUTION!!**

**To avoid personal injury:**

- **Be sure to install shields and safeguards attached to the engine when operating.**
- **Stop the engine at a flat and wide space when checking.**
- **Keep dust or fuel away from the battery, wiring, muffler and engine to prevent a fire. Check and clear them before operating everyday. Pay attention to the heat of the exhaust pipe or exhaust gas so that it cannot ignite trash.**

<b>ITEM</b>	
Parts which had trouble in previous operation.	
1. By walking around the machine	(1) Oil or water leaks
	(2) Engine oil level and contamination
	(3) Amount of fuel
	(4) Amount of coolant
	(5) Dust in air cleaner dust cup
	(6) Damaged parts and loosened bolts and nuts
2. By inserting the key into the starter switch	(1) Proper functions of meters and pilot lamps; no stains on these parts.
	(2) Proper functions of glow lamp timer.
3. By starting the engine	(1) Color of exhaust fumes
	(2) Unusual engine noise

### 4-2.2.3 Stopping the Engine

1. Return the speed control lever to low idle, and run the engine under idling conditions.
2. Set the engine stop lever to the "STOP" position.
3. With the starter switch placed at the "OFF" position, remove the key. (Be sure to return the engine stop lever to the "START" position to be ready for the next start.)

### 4-2.2.4 Checks During Operation

While running, make the following checks to see that all parts are working correctly.

#### Radiator Cooling Water (Coolant)

#### **WARNING!!**

**To avoid personal injury:**

**Do not remove radiator cap until coolant temperature is well below its boiling point. Then loosen cap slightly to the stop position, to relieve any pressure, before removing cap completely.**

When the engine overheats and hot coolant overflows through the overflow pipe and cannot be stopped, stop the engine immediately and make the following checks to determine the cause of trouble:

#### Check Item

1. Check to see if there is any coolant leak;
2. Check to see if there if any obstacle around the cooling air inlet or outlet;
3. Check to see if there is any dirt or dust between radiator fins and tube;
4. Check to see if the fan belt is too loose;
5. Check to see if radiator water pipe is clogged; and
6. Check to see if anti-freeze is mixed into coolant in warm seasons.

#### Oil Pressure Lamp

The lamp lights up to warn the operator that the engine oil pressure has dropped below the prescribed level. If this should happen during operation or should not go off even after the engine is accelerated more than 1000 rpm, immediately stop the engine and check the following:

1. Engine oil level (See "Engine Oil" in Maintenance Section).
2. Lubricant system (See "Engine Oil" in Maintenance Section).

#### Fuel

#### **CAUTION!!**

**To avoid personal injury:**

- **Fluid escaping from pinholes may be invisible. Do not use hands to search for suspected leaks; Use a piece of cardboard or wood, instead. If injured by escaping fluid, see a medical doctor at once.**
- **This fluid can produce gangrene or a severe allergic reaction.**
- **Check any leaks from fuel pipes or fuel injection pipes. Use eye protection when checking for leaks.**

Be careful not to empty the fuel tank. Otherwise air may enter the fuel system, required fuel system bleeding. (See "FUEL" in Maintenance Section).

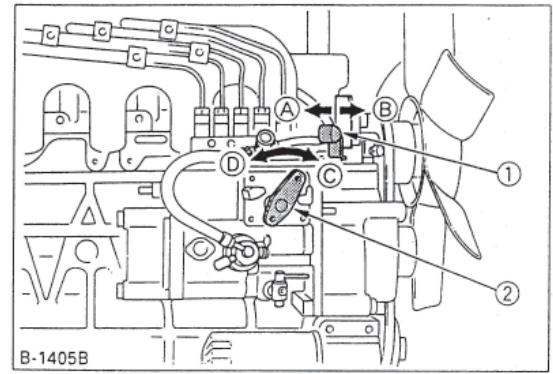

(1) Speed control lever  
(2) Engine stop lever

(A) "IDLING"  
(B) "OPERATION"  
(C) "START"  
(D) "STOP"

### Color of Exhaust

While the engine is running within the rated output range:

- The color of exhaust remains colorless.
- If the output slightly exceeds the rated level, exhaust may become a little colored with the output level kept constant.
- If the engine is run continuously with dark exhaust emission, it may lead to trouble with the engine.

### Immediately Stop the Engine If:

- The engine suddenly slows down or accelerates.
- Unusual noises suddenly sound.
- Exhaust fumes suddenly become very dark.
- The oil pressure lamp or the water temperature alarm lamp lights up.

## 4-2.2.5 Reversed Engine Revolution and Remedies

**CAUTION!!**

To avoid personal injury:

**Reversed engine operation can make the machine reverse and run it backwards. It may lead to serious trouble.**

**Reversed engine operation may make exhaust gas gush out into the intake side and ignite the air cleaner; it could catch fire.**

Reversed engine revolution must be stopped immediately since engine oil circulation is cut quickly, leading to serious trouble.

### How to Tell When the Engine Starts Running Backwards

1. Lubricating oil pressure drops sharply. Oil pressure warning light, if used, will light.
2. Since the intake and exhaust sides are reversed, the sound of the engine changes, and exhaust gas will come out of the air cleaner.
3. A louder knocking sound will be heard when the engine starts running backwards.

### Remedies

1. Immediately set the engine stop lever to the "STOP" position to stop the engine.
2. After stopping the engine, check the air cleaner, intake rubber tube and other parts and replace parts as needed.

## 4-2.3 Names of Parts

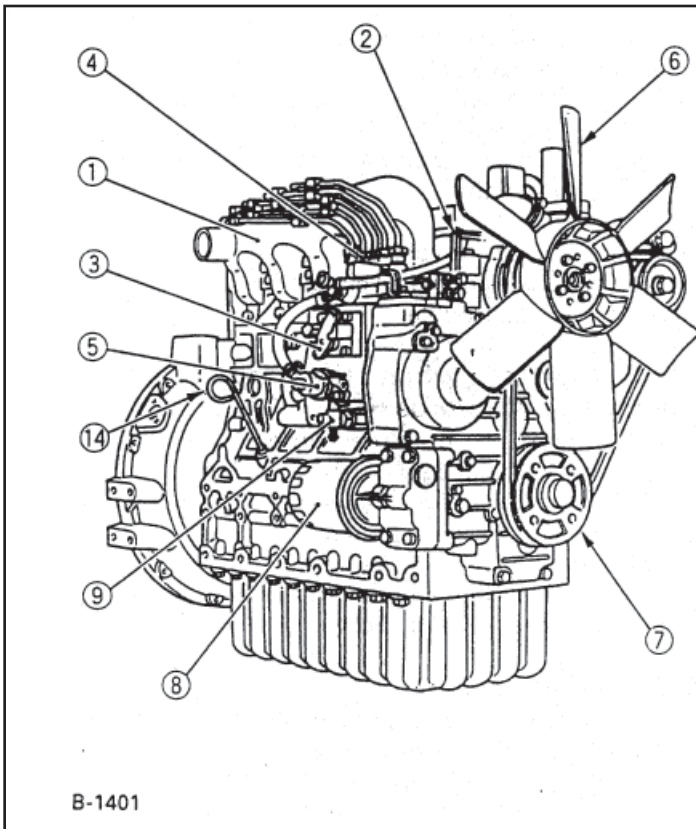

- (1) Intake manifold
- (2) Speed control lever
- (3) Engine stop lever
- (4) Injection pump
- (5) Fuel feed pump
- (6) Cooling fan
- (7) Fan drive pulley
- (8) Oil filter cartridge
- (9) Water drain cock

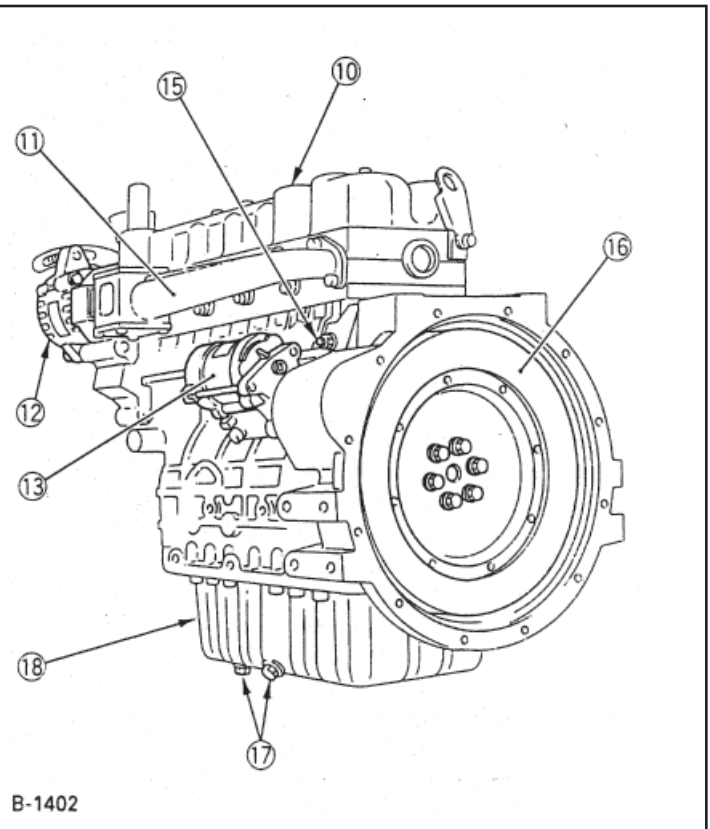

- (10) Oil filler plug
- (11) Exhaust manifold
- (12) Alternator
- (13) Starter
- (14) Oil level gauge
- (15) Oil pressure switch
- (16) Flywheel
- (17) Oil drain plug
- (18) Oil pan

## 4-2.4 Principles of Operation

The exciter pole pieces contain residual magnetism, setting up lines of force across the air gap to the exciter armature. When the exciter armature begins to rotate a voltage is induced and current flow is initiated in the exciter armature AC windings. This voltage is fed to the rotating rectifier assembly, rectified and fed to the alternator field coils. This DC voltage is sufficient to magnetize the laminated alternator field which will set up lines of force across the air gap to the alternator stator. As the generator rotor rotates a voltage will be induced and current will flow in the alternator stator windings and to the output circuit.

A static type voltage regulator is connected to the generator output. The regulator will rectify part of the output voltage to provide a DC voltage to the exciter field coils. This will increase the density of the lines of force in the exciter, increasing the voltage induced into the exciter armature windings, and therefore to the rotating rectifiers.

The rotating rectifier output will be increased, which will increase the alternator field strength and the generator output will build up to its rated voltage.

Adjustment of the generator output to the rated voltage level is accomplished by controlling the current fed to the exciter field coils.

Regulation is automatic with the static type voltage regulator. An additional voltage adjustment range is provided if desired by operating the voltage adjust rheostat.

**ROTATING FIELD ASSEMBLY (ROTOR)** - The rotating field assembly consists basically of four members; the shaft assembly, the core assembly, field coil damper windings and balance lugs to provide a high degree of static and dynamic balance. The exciter rotor and rotating rectifier-hub assembly are separate units which are heat shrunk onto the generator shaft.

**CORE ASSEMBLY** - The core assembly consists of one piece electrical steel laminations which are stacked on the shaft assembly.

**FIELD COIL** - Field coils of heavily insulated wire are "wet" wound directly onto the poles. Field coil leads are brought out to the rectifier assembly for connection to the source of DC excitation voltage.

**GENERATOR SHAFT** - The generator shaft is made of forged high strength steel, which is turned to close tolerances and then ground to a closer tolerance.

**GENERAL DESCRIPTION** - The revolving field type generators have a DC field revolving within a stationary AC winding called the stator. AC power is distributed from the generator through leads connected to the stator windings. There are no sliding contacts between the AC winding and the load, therefore, great amounts of power may be drawn from this generator.

**VOLTAGE CONNECTIONS** - The generator may be connected at the terminal board to deliver 120/240 volts to a 3 wire grounded neutral system, or 120 volts only to a 2 wire distribution system. If any equipment requires 240 volts, then the 120/240 volt connection must be used. If all equipment requires 120 volts, then the 120 volt connection is preferred even if two lines leave the switch box. The two lines at the input to the switch box are both connected to the ungrounded 120 volt lines from the generator. The 120 volt connection enables the EVR to hold the voltage very close the 115 or 120 volts (as initially adjusted) regardless of the power distribution among the different distribution lines. The 120 volt connection is recommended if all the electrical load requires only 115 or 120 volts.

Although the 120/240 volt connection may also be used when all load requires only 120 volts, it should be pointed out that this connection the 240 volt is regulated and the lightly loaded phase will deliver a high line-to-neutral voltage and the heavily loaded phase will deliver a low line-to-neutral voltage. The heavily loaded line may have such a low voltage that air conditioning will have more difficulty in starting, and long starting time may over-load generator and trip circuit breakers.



**ELECTRONIC VOLTAGE REGULATION** - Electronic Voltage Regulation (sometimes called automatic voltage regulation by many users) regulates the voltage by using a solid state electronic circuit of transistors, integrated circuits, SCR's, resistors, capacitors, etc., to sense the generator voltage and feed a DC current into the exciter field of the proper average value to hold the generator voltage constant from no-load to full rated load and above. These electronic voltage regulators are very reliable devices which regulate the voltage to 2% or less.

**BRUSHLESS EXCITER** - The brushless exciter consists of an armature with a three phase AC winding and rotating rectifier assembly within a stationary field.

The stationary exciter field assembly is contained in the main generator frame. The exciter armature is bolted fit and keyed onto the shaft assembly. The rotating rectifier assembly slides over the bearing end of the generator rotor shaft.

**DC OUTPUT POWER FOR EXCITER FIELD** - The EVR rectifies the AC power input with a full wave rectifier to provide DC current (a series of half sine waves) with a high ripple content at a frequency of 120 HZ. This DC current is fed to the exciter field through one (or two) SCR's to provide a pulsed output in one direction only. The resistance and impedance within the regulator is very low and the peak value of the current into the exciter field is limited only by the impedance and resistance of the exciter field. For this reason exciter fields must have a minimum specified resistance or the peak current delivered by the regulator will be so high that the regulator components will be damaged. The regulators are commonly designed for a minimum exciter field resistance of 25 OHM's, although sometimes a slightly lower resistance can be tolerated. Connections to the exciter field are made of two DC output terminals, F+ and C.

**ROTATING RECTIFIER BRIDGE** - The rotating rectifier bridge consists basically of rectifying diodes mounted on a heat sink which is in turn mounted on an insulating ring. The entire assembly bolts to the adaptor on the generator shaft. Therefore, the rotating rectifier assembly will rotate with the exciter armature eliminating the need for any sliding contacts between the exciter output and the alternator field. (See Figure 1).

**EXCITER FIELD** - The exciter field on the high frequency exciter consists of laminated segments of high carbon steel which are fitted together to make up the field poles. The field coils are placed into the slots of the field poles.

**EXCITER FIELD COIL VOLTAGE SOURCE** - Field coil DC voltage is obtained by rectifying the voltage from phase to neutral line of the generator output, or other appropriate terminal to provide the needed voltage reference.

The rectifier bridge is an integral part of the static regulator. The static regulator senses a change in the generator output and automatically regulates current flow in the exciter field coil current to increase or adjustable rheostat sized to be compatible with the regulator is used to provide adjustment to the regulator sensing circuit.

**BALANCE** - The rotor assembly is precision balanced to a high degree of static and dynamic balance. Balance is achieved with the balance lugs on the field pole tips. Although the balance will remain dynamically stable at speed in excess of the design frequencies, the prime mover should be adequately governed to prevent excessive over speed. High centrifugal forces at excessive over speed can damage the damper winding and field coils.

**BEARING** - The generator rotor assembly is suspended on shielded, factory lubricated ball bearings. They are greased for life and should not require regreasing.

**STATOR ASSEMBLY** - The stator assembly consists of laminations of steel mounted in a rolled steel frame. Random wound stator coils are fitted into the insulated slots.

**STANDBY UNITS** - Generators used as an auxiliary power source in case of commercial power failure must be isolated from the commercial line before being placed in operation.

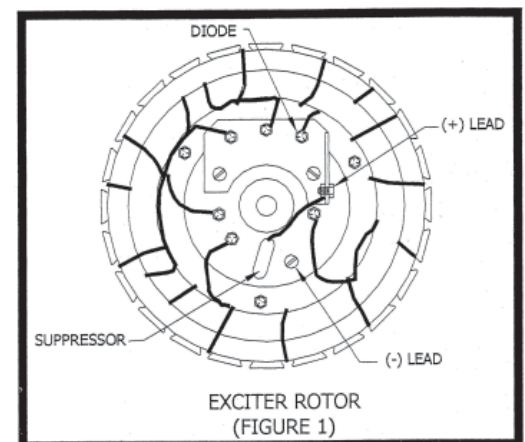
**CAUTION!!**

Make sure the unit is completely shut down and free of any power source before attempting any repair or maintenance on the unit.

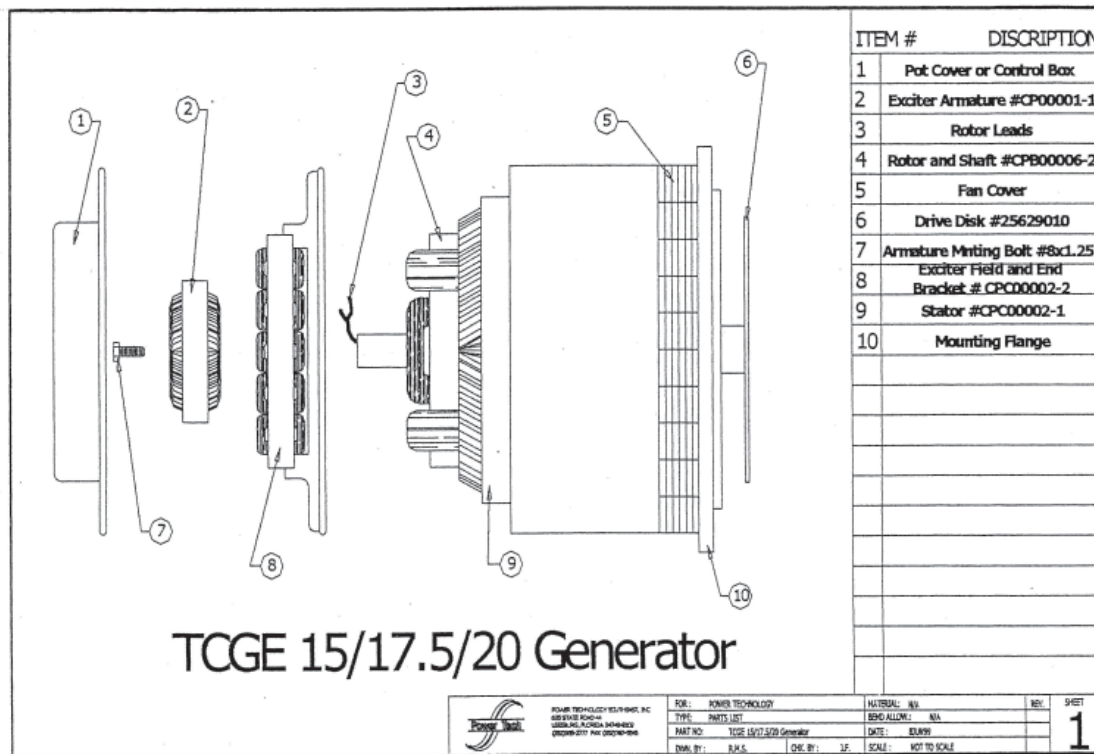

FIGURE 2

## 4-2.5 Service and Maintenance

### 4-2.5.1 Preventative Maintenance and Operating Precautions

Costly repairs and down time can usually be prevented by operating electrical equipment under conditions which are compatible with those at which the equipment was designed to operate. Follow the instructions outlined below to ensure maximum efficiency of the electrical equipment.

**CAUTION!!**

- Do not exceed air temperature rise as shown for 50 deg. C above 40 deg. C ambient.
- Do not exceed the rated voltage or load.
- Operate Genset at rated speed.
- Keep regulating equipment at proper adjustment.

### 4-2.5.2 Cooling

Keep all cooling parts clean and make certain sufficient room is left on all sides for a plentiful supply of fresh coolant air flow. Do not exceed air temperature rise as shown for 50°C above 40°C ambient. This ensures that the insulation NEMA class “F” will not be damaged. Do not exceed the rated voltage or load. Operate generator at rated speed. Keep regulating equipment in proper adjustment. Failure to operate generators at rated voltages, load or speed will cause overheating and possibly damage to the windings due to over voltage or current.

### 4-2.5.3 Regulating Equipment

Regulating equipment should be kept in proper adjustment at all times. Read all instructions carefully before adjusting or repairing the regulating equipment.

**CAUTION!!**

Read all instructions carefully before adjusting or repairing the regulating equipment.

## 4-2.5.4 Bearing Replacement

Factory lubricated shielded bearings will normally provide several years of trouble free service when operated under normal conditions. Excessive bearing load and adverse environment conditions will greatly shorten bearing life. Should bearing failure occur, bearings can be replaced. ALWAYS REPLACE WITH THE SAME TYPE BEARING AS INSTALLED AT THE FACTORY. CHECK PART LIST FOR PART NUMBER. Include generator serial number when ordering bearings.

## 4-2.5.5 Rotating Diode Bridge

The rotating diode bridge can be removed and replaced. Excessive over current, over voltage, overspend, or reverse currents can cause damage to the assembly or any of the component parts.

All rotors are static and dynamically balanced to a high degree on precision machines to assure minimum vibration. They will therefore, remain dynamically stable at speeds well beyond the synchronous speed of the generator. The rotors on generators are, however, subjected to extreme centrifugal forces which can increase beyond safe operating limits at excessive over speed. Therefore, the prime mover should be adequately governed to prevent over speed. Damage to the rotor can also occur due to overheating which can be caused by one of the following:

1. Excessive field current due to failure of the regulator.
2. The exciter being operated below the rated speed which can result in excessive field current due to the regulator trying to maintain rated voltage.
3. The air flow is restricted from dust or other foreign objects collecting in the air passage.

If a rotor becomes defective, it should be returned to the factory with full nameplate data, because the rotor coils are enclosed in welded squirrel cage winding. Should a failure occur, the factory should be notified immediately and steps will be taken to get the generator back into service with the least expense; and more important, to determine the cause of the failure and take steps to prevent recurrence.

## 4-2.6 Precautions

### 4-2.6.1 Generator Winding (Drying)

Generators that have been in transit or storage for long periods may be subjected to extreme temperature and moisture changes. This can cause excessive condensation, and the generator windings should be thoroughly dried out before bringing the generator up to full nameplate voltage. If this precaution is not taken, serious damage to generator can result. The following steps should be taken to effectively dry the generator windings:

1. Short circuit the generator lead wires. Start the generator and separately excite the exciter with DC battery power of approximately 50 volts to produce rated AC nameplate current. To accomplish this excitation, the leads (F+ and C-) must be disconnected from the voltage regulator. Nameplate current can be measured with a clip-on ammeter at the generator leads. Make sure the AC current does not exceed the nameplate rating. Be sure to reconnect the leads to the proper terminals on the voltage regulator after the drying exercise.
2. Another procedure would be to put the generator in a heated room or to moderately heat with a heat source.

Experience has shown that it is necessary to take these precautions in locations such as seaboard installations and other highly humid areas. Some installations will be in atmospheres that are much more corrosive than others. A little precaution along the lines outlined here could eliminate an unnecessary repair job.

### **WARNING!!**

**High voltage (dielectric) testing must not be performed to the machine without first observing NEMA rules. The insulation of this generator winding may be safely checked by using a megger. A high megger reading indicates low insulation leakage.**

Each generator was subjected to a standard NEMA insulation test, which means 1000 volts plus twice the highest voltage for which the generator is rated was impressed between the windings and the frame. All machines are insulated with a high safety factor for the class of insulation used. The latest and newest in insulation and baking techniques are used.

The finest insulation job can be very quickly broken down by carelessly applying high voltage to windings in a moisture saturated condition. Mishandling in this respect can easily cause a break down, making it necessary to return the generator to the factory for repair, and consequent expense and loss of time.

### 4-2.6.2 Field Flashing

The direct current (DC) necessary to magnetize the alternator field is obtained from the exciter. Initially, upon starting the generator, current flow and voltage are induced into the exciter armature by the magnetic lines of force set up by the residual magnetism of the exciter field poles.

Residual magnetism of the exciter field poles may be lost or weakened by a momentary reversal of the field connection, a strong neutralizing magnetic field from any source, or if the generator is not operated for a long period of time.

To restore the small amount of residual magnetism necessary to being the voltage build up, connect a battery from 6 to 32 volts to the exciter field coil circuit. Normally, a battery of 6 or 12 volts is large enough.

#### Procedure for Field Flashing to Restore Residual Magnetism

1. Disconnect the exciter field coil wire F+ at terminal F+.
2. Connect a batteries positive lead to the field coil lead F+. Use 12 volt battery.
3. Connect the batteries negative lead to the field coil circuit terminal C.
4. Disconnect the battery leads after approximately 3 to 5 seconds. If the battery is connected for too long, over heating and subsequent damage to the exciter can occur.
5. Reconnect the field coil lead F+ to terminal F+.
6. Start the unit and observe the generator build up.

**NOTE:** If the polarity of the exciter is reversed by flashing the field, it may be corrected by interchanging the battery leads.

Reflash field (steps 1 through 5 above) if the generator voltage does not build up.

### 4-2.6.3 Alternate Procedure for Field Flashing

Apply either an alternating current or a direct current voltage of approximately 12 volts to any tow generator leads. Do not make a positive connection but rather touch the leads together until the generator voltage begins to rise and then separate the leads. It is suggested than a 30 ampere fuse be inserted in the circuit to prevent any damage in case the build up voltage is not removed quickly enough.

Start the generator and observe generator build up. Reflash field if generator output voltage does not build up. This procedure should be performed by Trained Service Personnel only. (See Figure 1)

### 4-2.6.4 Testing Diodes with an Ohmmeter

Isolate the rectifier assembly by disconnecting the lead from the main rotor and tree leads from the exciter rotor. Test each diode by applying the probes of an ohmmeter to the anode and cathode.

A good diode will produce a meter reading of only a few OHM's when the probes are applied in one direction, and a reading of near infinity when the probes are reversed. If both readings are high, or both are low, the diode is defective and must be replaced.

Diode failure after 25 hours "run in" period is generally traceable to external causes such as overheating or a reverse current fed into the alternator. To save excessive service time and call backs, it is a generally accepted practice to replace all diodes where failure can be traced to external causes after the cause of the diode failure is identified and corrected.

### 4-2.6.5 Troubleshooting Procedure for AC Brushless Generator

As with any machine, trouble may develop in electrical generators. It may be due to long service or neglect of regular maintenance, servicing, and checking. Should trouble develop, the following instructions will be helpful in tracing the cause and making repairs.

Brushless generators are not complete units without added control equipment, therefore, reference will be made to control components.

### 4-2.6.6 Voltage Deviations

The generator output voltage should be kept as close as possible to the rated voltage shown on the generator nameplate. High voltage, low voltage and fluctuating voltage (hunting) may cause serious damage to the generator and its control equipment. A high voltage could damage sensitive equipment and low voltage could cause motors to burn out.

### 4-2.6.7 Speed Deviation

The generator speed should be maintained at rated nameplate speed. The frequency of the generator output depends on speed. If the generator runs slower than the rated speed, the voltage may drop off. Automatic control equipment may burn out trying to maintain voltage by forcing the field.

### 4-2.6.8 Visual Examination

The first step in investigating any generator failure or trouble should be to look for obvious evidence such as: burned areas, loose or open connections, wrong speed, incorrect reassembly and reconnection, etc.

### 4-2.6.9 Observe Voltage of Defective Generator

The next step is to carefully measure line to line voltage. A voltage about 10% of the rated voltage (at rated RPM) is probably the residual voltage (determined by residual magnetism in the exciter field). A normal residual voltage indicates exciter armature, rotor and stator are all good and that the trouble is probably in the excitation circuit. A very low voltage, or no voltage, indicates either the residual magnetism in the exciter field was lost (generally by disassembly or by sudden interruption of the exciter field current), or that a generator defect exists in the exciter armature, rotor or stator.

### 4-2.6.10 Battery Excitation

The behavior of the generator, when the exciter field is connected to a 12 volt battery for excitation current, is a useful guide for location the generator fault. Disconnect F+ from C- from EVR and open CBI circuit breaker/switch in lead 3 or 4 to EVR (lead for power input to the EVR). Connect F+ to the positive side of the battery. Connect the negative side of the battery to C-. Spin the generator at 1800 RPM.

- A. If residual voltage is normal, 12 volts across lead F+ and C- should cause the generator to deliver a voltage near rated voltage with no load. If 12 volt excitation produces near normal voltage, failure of the voltage regulator to provide the voltage could mean a defective voltage regulator, or an open circuit in leads to terminals 3 or 4 of the electronic regulator. Check the switch or circuit breaker in these leads. With 12 volt excitation, connect voltmeter across terminals 3 and 4. Voltage should be 200 to 240 volts with CBI closed.
- B. If 12 volt excitation produces no voltage, check the exciter field resistance. It should normally be 25 to 28 OHM's at 77 deg. F. If the field is open or shorted, then the exciter field is defective. An open or short in the main rotor behaves similarly, but is also accompanied by a very low line to line voltage (residual voltage) without 12 volt battery excitation. If an open or shorted rotors suspected, remove "R" lead from #10 base terminal on the armature and measure the resistance since "Q" lead is normally connected to ground. See "Resistance of Rotors".

- C. If 12 volt excitation causes the engine to growl and load the engine with no or very low generator output voltage, the stator could be grounded or shorted. Or, a short or ground in the wiring of the generator power circuit could be the main fault. In either case, the stator will develop hot spots or could even smoke after running a few minutes. Run the generator until a hot smell is detected, or stop in 5 minutes (whichever occurs first). Feel the stator winding. If it is not, the stator or power wiring contains a short circuit. Examine the stator for burned (black) insulation which indicates a defective or damaged stator. Measure the stator resistance T1 to T2 and T3 to T4 if possible. With 12 volt excitation measure the voltage of T1 to T2 and T3 to T4. If one of these voltages is very low while the other is close to normal, the low voltage winding has shorted turns.
- D. If 12 volt excitation causes an increase in voltage but the output voltage is less than 60% of the rated voltage, the rectifier (see 4) in the exciter armature could be defective or the exciter armature could have an open circuit. Also, one pole of the main field (rotor) could be shorted or grounded. If any of these effects exist, failure of the electronic regulator will occur. Replacement of the regulator alone will be followed by failure of the new regulator. If the electronic regulator has failed, it is wise to check the exciter current by placing a DC Ammeter in the F+ lead to the exciter field. Normal exciter current at no load rated voltage is 0.65 to 0.95 ampere. A higher current is another indication of a generator defect (described above), which could cause a new voltage regulator to fail.

### 4-2.6.11 Rectifier Checking

- A. Each armature full wave bridge rectifier has 5 terminals and 6 rectifying junctions. Rectifiers may be readily checked on the low range of an ohmmeter. From the "+" tab to the "AC" tab the ohmmeter should show a high resistance when polarity of the ohmmeter leads are reversed. The same conditions should be found from the "+" tab to any other "AC" tab and from "-" tab to "AC" tabs. If a ZERO resistance reading is found, this junction of the rectifier is shorted and the rectifier must be replaced. If a HIGH resistance is found with both polarities of the ohmmeter, this junction of the rectifier is "OPEN" and the rectifier must be replaced.
- B. Armature with 3 phase FULL-WAVE bridge rectifier. The three phase full-wave rectifier is now standard on most armatures used in generators. This 3 phase (full-wave rectifier) is a single unit with 6 diodes in a special case. The (+) terminal is identified by a red dot on the case and is connected by a short lead to the (+) terminal of the armature to which the (+) rotor lead and suppressor leads are connected. The other 3 terminals at the top of the rectifier are AC connections to each of the armature phase leads. The case is the (grounded) (-) lead to the rotor. To test the diodes disconnect the rectifier positive lead at the armature (+) terminal. Test between the rectifier (+) and any AC terminal. Make the test also between the rectifier (-) lead (ground to case) to any AC lead. The test determines that all diodes are good or that one or more is defective. Since a ground armature winding gives the same test results as a bad diode, it is necessary to disconnect all AC rectifier connections and test the armature windings for a short to ground before a fault can be positively identified. Also test each diode separately (-) to each AC terminal, and case to each AC terminal to positively identify which diode is bad.
- C. The armature with two full-wave bridge rectifiers. On some generator models an armature will be supplied with two full-wave bridge rectifiers very similar to the rectifiers used on armatures with one 3 phase FW rectifier. To test these rectifiers, remove the two rectifier (-) leads at the R (rotor) (+) terminal and test each rectifier separately, first from + lead (rectifier #10) to any AC terminal. Then go to rectifier #2 and test + to any AC terminal, then case to any AC terminal. A failure in the test "case to any AC terminal" could be a bad diode in either FW bridge rectifier. To determine which diode is bad, all AC terminals must be disconnected and each AC terminal of the rectifier tested to both + and to - (case) of that bridge rectifier.

### 4-2.6.12 Voltage Suppressor

Voltage suppressors are similar to rectifiers in that they contain in effect a single semiconductor one way junction. A suppressor should have a high resistance with one polarity of test leads and low but not zero resistance in the opposite direction. Resistance measurements sometimes fail to identify a defective suppressor. The best test is to remove the suppressor from the circuit. If an obvious improvement in the generator is observed, the suppressor is bad. Some suppressors have a high resistance in either polarity of applied voltage (if applied voltage is low), but have a low resistance of voltages of 300 to 450 volts.

### 4-2.6.13 Resistance of Windings

Frequently in troubleshooting a generator, a defective component can be identified by measuring the resistance of a winding. The Exciter field, armature, rotor and stator should withstand 1500 volts between winding and ground with less than 0.002 ampere of current between winding and ground. All electronic components such as rectifiers, suppressors, and resistors must be disconnected.

GENERATOR RESISTANCE VALUES								
ARMATURE		470-520 OHMS PER PHASE			5 TO 10 KW			
		650-720 OHMS PER PHASE			12.5 TO 50 KW			
FIELD		18-22 OHMS			5 TO 10 KW			
		23-28 OHMS			12.5 TO 50 KW			
Stator OHM's vary with KW rating, but less than 1 OHM per phase.								
ROTOR:								
8	10	12.5	15	17.5	20	25	30	50
1.47	1.58	1.73	1.84	2	2.1	2.2	2.5	3.8

#### 4-2.6.14 Electronic Regulation

An electronically regulated generator has superior voltage regulation than other types (+/- 2 deg. within rated loads). Power Technology Southeast, Inc. uses voltage regulators made by Basler Electric Co., Highland, Illinois. The electronic voltage regulator, regulates the voltage using a solid state electronic circuit of transistors, integrated circuits, SCR's, resistors, etc. To sense the generator voltage and feed a DC current into the exciter field of the proper average value to hold the generator voltage constant from no load to full rated load and above.

**Characteristics: Overload Protection** - To prevent damage to devices receiving electrical power from the generator. The regulator provides both under load frequency and over load protection. The voltage regulator operates at 50 HZ, the voltage does not rise above that value set at the proper frequency (proper engine speed). AC Power Input - All EVR's must supply up to 4 amperes of DC output current into the exciter field at a voltage up to 70 volts DC. This voltage and current constitutes a power output of about 280 watts. This output power must come from the generator. The exciter field input power must be supplied at 190 to 240 volts AC at a volt ampere burden of 500 VA maximum. When the generator is connected to deliver 120 volts, a separate winding in the stator provides 208 to 240 volts for the voltage regulator power input.

**DC Output Power for the Exciter Field** - The EVR rectifies the AC power input with a full wave rectifier to provide DC current (a series of half sine waves) with a high ripple content at a frequency of 120 HA. This DC current is fed to the exciter field through one or two SCR's to provide a pulsed output in one direction only. The resistance and impedance within the regulator is very low and the peak value of the current into the exciter fields must have a minimum specified resistance or the peak current delivered by the regulator will be so high that the regulator components will be damaged. The regulator is commonly designed for a minimum exciter field resistance of 20 OHM's 8-10 KW and 25 OHM's 12-50 KW, although sometimes a slightly lower resistance can be tolerated. Connections to the exciter field are made at two DC output terminals, F+ and F-.





## 4-3 Inverter

The 450 LXi is equipped with a Vanner ITC-Series inverter/charger system. This is a very important system within the coach. This system can pull power out of 12-volt batteries and convert it to 120 VAC to run appliances. It can also pull 120 VAC power and convert it to 12 volt as needed to charge the house batteries when connected to 120 VAC shore power or generator. Lights on the motor home use 12 volt and appliances use 120. This is useful when you are some place that does not have plug-ins or you cannot run the generator for some reason. For example, maybe the park you are in has rules that state no running generator after a certain time; this is where your inverter would come in handy.

### 4-3.1 Inverter Overview

An inverter converts DC electrical power into AC power. This power can be used to operate various AC-driven appliances.

The most common battery systems are 12 or 24 volt. Some systems, however, operate on higher voltages such as 32, 36, 48, or 120 volts. The most common inverter AC output power is 120 volts at a frequency of 60 Hz, although some inverters are designed to produce 240 volts, or both 120 and 240 volts at 60 Hz. Because some countries use power of different voltage and frequency (e.g. 230 volts at 50 Hz), inverters are available to conform to these requirements.

Inverters use electronic circuits to switch DC input power at the required frequency, such as 60 Hz. This “switched” DC resembles AC power, and is then stepped up in voltage through a transformer. The result is a modified sine wave AC output of the required voltage and frequency that can power AC-driven equipment.

### 4-3.2 System Features and Specifications

#### 4-3.2.1 General Description

The ITC-Series system consists of a DC to AC true sine wave inverter, a battery charger, an automatic AC transfer switch, and a microprocessor based controller. An important feature of this system is the ITC-Series Control/Display Unit user interface.

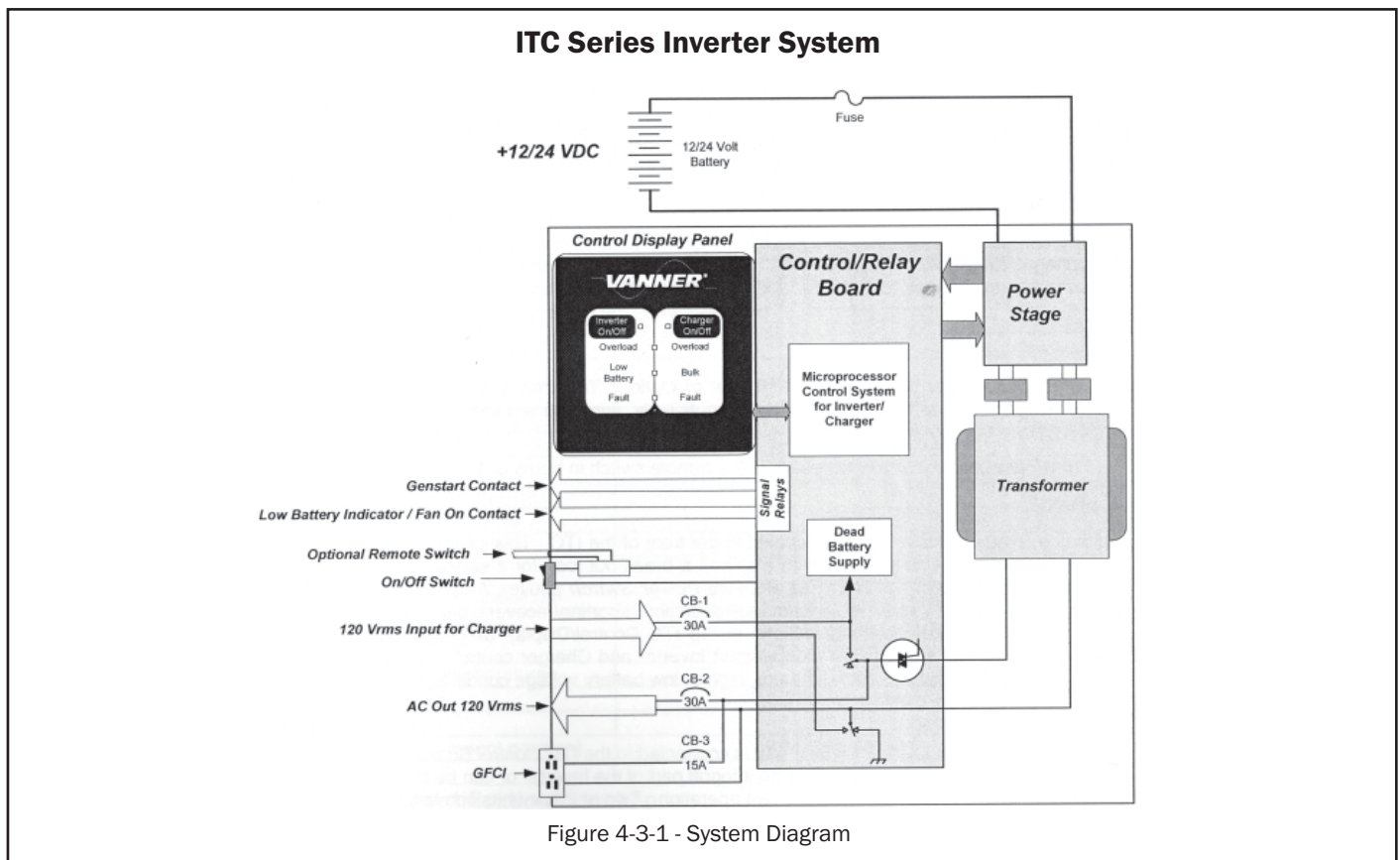

## 4-3.2.2 System Features

### ***Inverter***

The inverter consists of a true sine wave inverter that supplies power when AC loads are applied. This model develops 3600 watts of continuous power. Using TruSine® technology, a very high quality sine wave is produced. Total harmonic distortion (THD) is less than 4.0 percent.

### ***Battery Charger with Automatic Power Management***

The high efficiency, multi-stage battery charger allows automatic charging of flooded lead acid and gel type batteries. The efficient 0.85 power factor or PF, compared to typical 0.59PF on triac plus type chargers, allows full charger output from a 30-amp AC source. The system's Bulk, Absorption, and Float charge cycle quickly charges and maintains the battery bank. An Equalization charge cycle is available for flooded lead acid battery maintenance. In addition, there is an optional battery temperature sensor to reduce battery float voltage as temperature increases above 25° Celsius.

Automatic Power Management (APM) monitors the AC Input current and will reduce the battery charger output as needed to keep the AC input current below the preset APM Limit.

### ***GenStart Contact***

The GenStart feature provides a start/stop signal to control an automatic generator. The start/stop signal consists of a contact closure to start the GenStart based on battery voltage of 12.3 (24.6) VDC. The GenStart turns off when the battery charging current falls below 10 amps.

### ***Low Battery or Fan On Contact***

The Low Battery contact allows remote monitoring of the Inverter's battery status. The contact will close when battery voltage falls below 11.0 (22.0) volts. This will alert the user to take appropriate measures to avoid shutdown of the Inverter at 10.5 (21.0) VDC. The SP00172 offers a Fan On contact instead of the Low Battery contact for turning on an external fan or blower when the ITC's fan is on.

### ***Remote Power Switch***

This loop between Options Terminal 7 and 8 (left side of Options Terminal) allow remote control of the system On/Off. Tying these two terminals together or optionally, tying the terminal 7 (Remote Switch) to battery ground applies power to the unit.

** NOTE: The Front Panel switch will always overrule the remote switch in terms of disabling the unit.**

### ***System Control***

The ITC contains a System ON/OFF Switch located in the front of the ITC. This switch is used to turn the control power ON and OFF. This power switch also has a break out loop for a series switch that can be placed in a remote location from the unit (See Remote Power Switch above). A control microprocessor provides a variety of protection interlocks, system fault detection/reporting, recovery, storage of system data parameters, and high-speed data communications to the ITC Control/Display Unit. This Control/Display Unit also has individual on/off switches for independent Inverter and Charger control. The ITC will protect itself in the event of any overload, over temperature, high or low battery voltage condition.

### ***ITC Control/Display Unit***

The ITC Control/Display Unit is a user interface that is connected to the ITC Control Board via a 6-wire modular cable. This Control/Display unit can be an integral part of the Inverter or can be removed and mounted in a remote area to allowing remote system operation. Two of these units can talk to the System Control Board one display would be configured as a Master, and the other as Slave. The configuration switches on top of the Master allow programming of the Charger current, Automatic Power Management and battery type settings.

** NOTE: It should be noted that if the Control Display unit is taken out of the front of the unit, the cover plate (Vanner Part #D011339) must be installed in it's place to insure that debris does not enter the unit through the opening and to maintain proper airflow through the unit.**

Model	ITC24-3600 SP00172	Model	ITC24-3600 SP00172
<b>AC OUTPUT</b>		<b>INVERTER EFFICIENCY @ Nom.</b>	
Voltage (RMS)	120 VAC	200 watts	77%
Frequency	60 Hz $\pm$ 0.5%	500 watts	85%
AC Waveform	Pure Sine Wave	700 watts	87%
Total Harmonic Distortion (THD)	Less than 4.0% @ full power	1000 watts	89%
Power Factor Allowed	-1 to 1	1500 watts	90%
Continuous Output Rating @ 25°C		2000 watts	89%
Phase to Neutral	3600 watts (30.0 amps)	2500 watts	89%
Surge Capacity @ 25°C (3 sec.)	6400 watts	3000 watts	88%
<b>DC INPUT:</b>		3200 watts	87%
Operating Range (12 Volt Nominal)	21.0 to 31 Volts	3600 watts	87%
No Load, Inverter ON	2 amps	<b>AC INPUT</b>	
No Load, Inverter OFF	0.30 amps	Voltage	120 Volts Nominal
Full Power	175 amps	Frequency	60 Hz $\pm$ 12.5% (52.5 to 67.5)
<b>SYSTEM</b>		<b>AC TRANSFER SWITCH</b>	
Ambient Operating Temperature	-40 to +40°C (-40 to +104°F)	Power Rating	30 amps @ 120 VAC
Cooling Exhaust Fan	Thermostatically Controlled	Transfer Time	Less than 40 milliseconds
Mounting	Shelf or suspended	<b>BATTERY CHARGER</b>	
Dimensions (Bottom mount position)	8¼"H x 18 7/16"W x 13⅝"D	Charger Output Current Maximum	60 amps
Weight	66 pounds	AC Input Current Maximum	30 amps (0.88PF @ rated output)

### Component Identification/Location

The figures on the next page show the location of the various components of the ITC system.

ITEM #	DESCRIPTION
1	BATTERY TERMINAL ACCESS
2	REMOTE CABLE INPUT
3	CONTROL/DISPLAY PANEL
4	INVERTER ON/OFF SWITCH
5	CHARGER ON/OFF SWITCH
6	SYSTEM ON/OFF SWITCH
7	AC INPUT BREAKER (CB-1)
8	AC OUTPUT BREAKER (CB-2)
9	GFCI BREAKER (CB-3)
10	AC INPUT CABLE ENTRY
11	BATTERY +
12	BATTERY -
13	GFCI OUTLET
14	AC OUTPUT CABLE ENTRY
15	OPTIONS CABLE ENTRY
16	CHASSIS GROUND

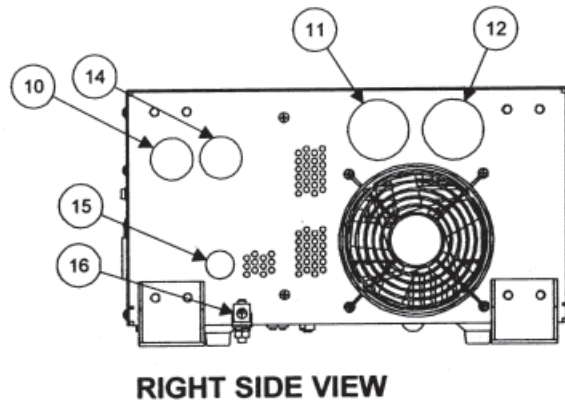
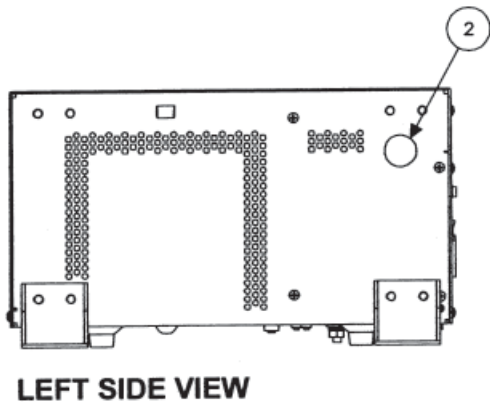
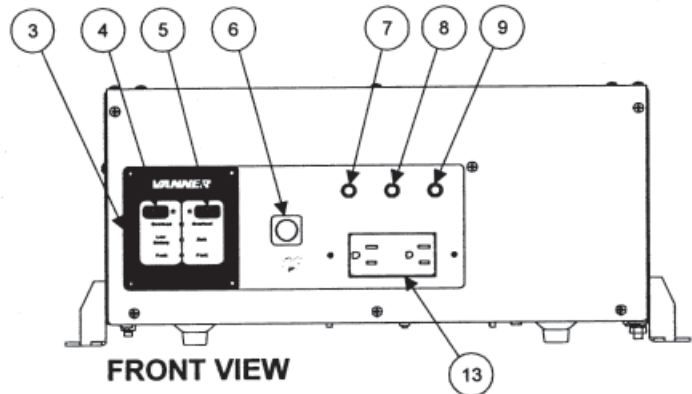
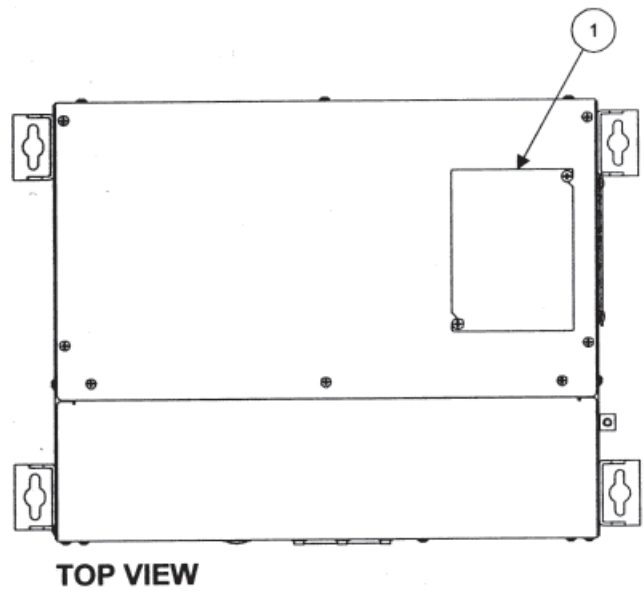

Figure 2 - Component Location

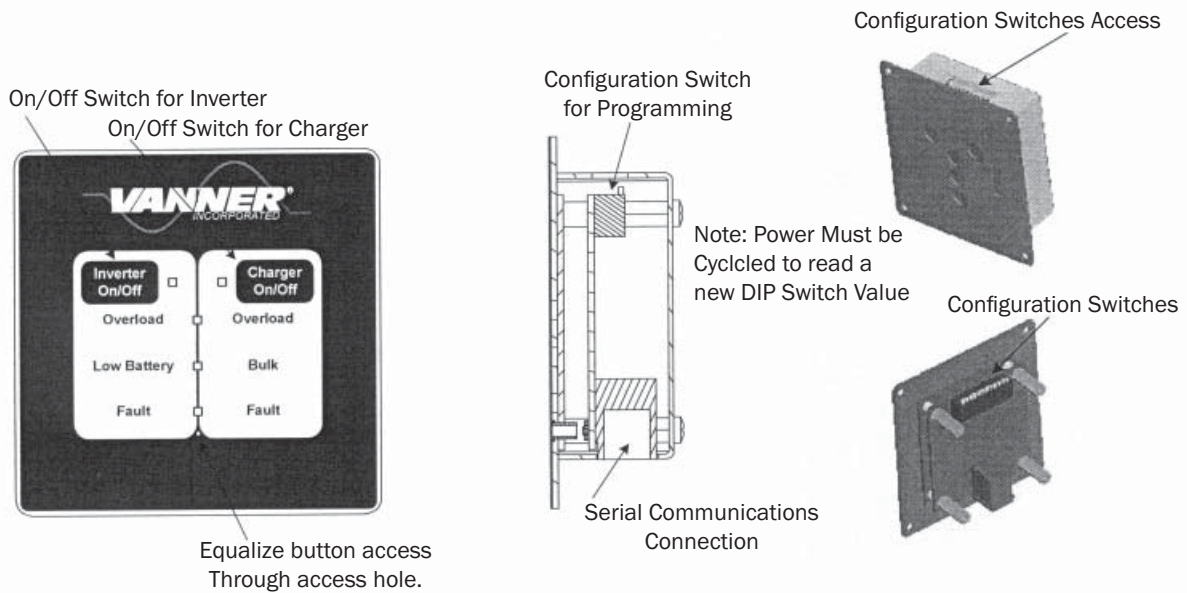

Fig. 3 - ITC Control/Display Unit

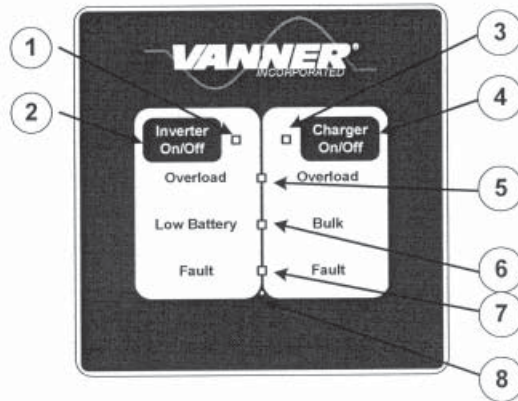

Fig. 4 - ITC Control/Display Unit Component Identification

ITEM	DESCRIPTION
1	Inverter Indicator Light Solid when on, flashes when enabled but not on
2	Inverter On/Off Button Enables/Disables Inverter Function
3	Charger Indicator Light Solid when on, flashes when enabled but not on
4	Charger On/Off Button Enables/Disables Charger Function
5	Overload Light Indicates if Inverter Overloaded
6	Low Battery/Bulk Light Dual Purpose - Indicates Low Battery in Inverter Mode. In Charger Mode - if on indicates that Charger is in Bulk Mode and if in Equalize, this light flashes.
7	Fault Light Dual Purpose - Indicates that a fault has occurred in the inverter or Charger. Could be a Over Temperature shutdown, Low/High Battery Shutdown, Power Stage Fault.
8	Equalize Button Access This is used to enable the equalization cycle on the battery during charging. <b>Note: Master remote can only initiate the equalize cycle. Slave remote cannot initialize equalize cycle.</b>

## 4-3.3 Description of Operation

### 4-3.3.1 Inverter

The System ON/OFF Switch, located on the front panel, allows the user to turn the system power ON and OFF and to reset the system after a fault.

The Charger ON/OFF and Inverter ON/OFF buttons, located on the Control/Display Unit enable or disable the Charger or Inverter Functions. The corresponding light next to Inverter/Charger buttons will be steadily on when the unit is in the Inverter or Charger mode. These Inverter and Charger lights will blink if the mode is not currently on, but are enabled.

**For Example: The Inverter light will blink when the Inverter is Enabled, the ITC is plugged into the utility, and the Charger is Active.**

The Inverter AC Output Circuit Breaker is a 1 pole, 30-amp breaker marked “CB-2” on the front unit. The CB-2 breaker protects the Inverter AC output and a second Breaker (CB-1) protects the Battery Charger AC input against a severe overload. This CB-1 breaker also protects AC Pass through Power. If this CB-1 breaker trips during charger operation, it must be reset.

### 4-3.3.2 Inverter Protective Interlocks

The Inverter operation is protected by a series of safety interlocks that protect against most failures such as overloads, over-temperature conditions or other conditions where the unit may be asked to operate outside safe battery voltages. These situations will trigger a display of the “Overload”, “Low Battery” and “Fault” indicators on the Control/Display panel and are listed below:

<b>Overload</b>	Inverter AC output current is at the Maximum Current allowed and is presently in “Surge”. The AC voltage will decrease if load increases. Overload Shutdown will occur if voltage goes below 105 VAC for 3 seconds.
<b>Dead Battery</b>	The inverter continually monitors battery voltage. If battery voltage falls below the Low Battery Shutdown 10.5 (21.0) VDC setpoint the inverter will shut OFF. Auto-reset will restart the inverter after battery voltage rises above the Low Battery Warning 11.0 (22.0) VDC setpoint (after 5 minutes).
<b>High Battery</b>	The inverter will shut OFF if battery voltage rises above the High Battery 16.0 (31.0) VDC setpoint.
<b>Battery Low Warning</b>	Battery voltage is below Low Battery Warning setpoint and soon may reach Low Battery Shutdown setpoint of 11.0 (22.0) VDC.
<b>Over Temperature</b>	The inverter will shut OFF if internal temperature sensors detect a high temperature condition that could damage the inverter.
<b>Hardware Fault</b>	Internal protection circuit activated or power brick high temperature will shut down system.

**If the unit has faulted there are the two following options:**

- 1. Auto-restart** After shutting down for any of the above fault conditions, the inverter will try to restart itself every 5 minutes if Auto-Restart is Enabled and the fault condition no longer exists.
- 2. Manual restart** You can manually restart the system after the fault conditions are removed. Reset the inverter by turning the System ON/OFF Switch OFF and then ON.

### 4-3.3.3 Battery Charger

The battery charger's advanced design incorporates an automatic, multi-stage charger. This design enables the unit to automatically charge batteries, which maintains the battery's integrity and reduces the likelihood of premature battery failure. In addition, the battery charger can utilize the remote battery temperature sensor to reduce the float voltage based on battery temperature. The battery charger is designed to be used with lead-acid type batteries including sealed and gel types, but not for nickel-cadmium (Ni-Cad) or nickel-iron types.

### 4-3.3.4 Battery Charging Sequence

#### Stage 1: Bulk Charge Stage

The charger always starts in the Bulk Charge Stage each time shore power becomes present and/or each time the charger is turned ON. In the Bulk Charge Stage, the system charges at the "Bulk Charge Amps" setpoint until the battery voltage rises to the "Bulk Charge Voltage" setpoint. Then the voltage is held at the setpoint until charging current has fallen to 5 amps above the "Battery Absorption Amps". This ends the Bulk Charge Stage and begins the Absorption Charge Stage. The charger will not enter the Bulk Stage again until shore power is re-applied, or until the charger or the system is turned ON again.

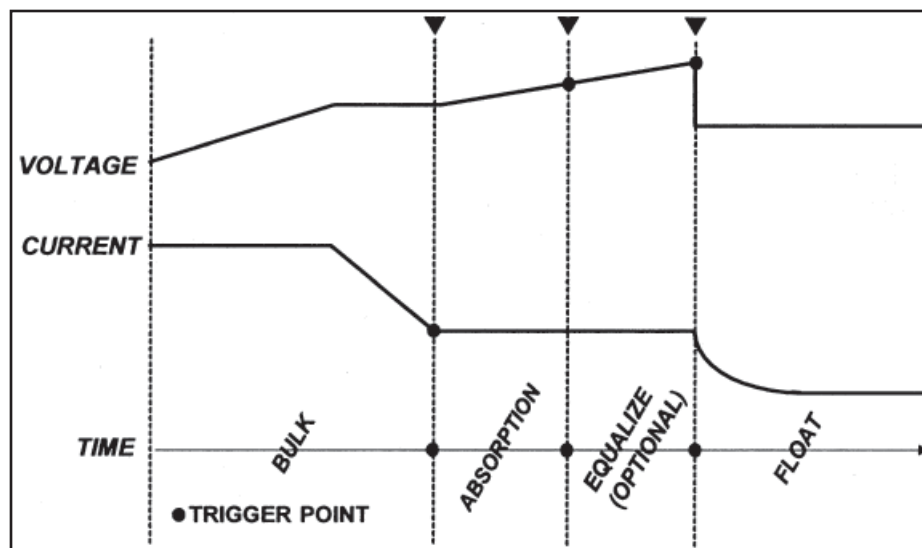

Figure 4 - Charging/Voltage Curves

#### Stage 2: Absorption Charge Stage

The Absorption Charge Stage provides a controlled "overcharging" of the battery that is necessary to bring the battery up to the full charge. The battery is charged at the "Absorption Charge" until one of the following three conditions occur that signals the end of the Absorption Stage:

Time: The Absorption Maximum Time setpoint is reached

Time: The Absorption Charge Stage time has reached  $\frac{1}{2}$  of the duration of the Bulk Charge Stage.

Voltage: Battery voltage reaches the "Absorption Voltage" setpoint

#### Stage 2A: Equalize Charge Cycle

When Equalize Mode is ENABLED (by inserting a paperclip or similar device through the "master" Control/Display unit Equalizer Hole), one Equalize Charge Cycle will follow the Absorption Charge Stage. The Equalize Cycle will last for the "Equalize Time" setpoint of 15 minutes. Equalize Mode will automatically switch to DISABLED at the end of the Equalize Charge Cycle. During the Equalize Cycle the battery is charged at the "Absorption Charge Amps" setpoint and the Equalize Voltage 15.5 (30.0) VDC setpoint.

The Equalize Charge Cycle provides a deliberate overcharging of the battery to remove sulfate, which accumulates on the battery plates through normal use. Equalizing returns battery cells to equal performance levels, which improves battery performance and extends battery life. Consult the battery manufacturer for their recommendations regarding how often the Equalize Cycle should be performed.

**CAUTION!!**

**Do not equalize sealed (valve regulated lead acid, AGM or gel) batteries! Consult battery manufacturer for equalizing guidelines. Do not equalize more often than approximately once a month. Check battery fluids after equalizing is complete, as gassing will occur. Use Equalize Mode only if batteries are in a well ventilated area!**

**Stage 3: Float Charge Stage - Maintenance Mode**

In the Float Stage the charging voltage is reduced to the “Float Charge Voltage” setpoint and charging current is limited to the “Absorption Charge Amps” setpoint. The charger will remain in the Float Stage until shore power is reapplied, or until the charger or system is turned OFF and then ON again.

**4-3.3.5 Charging Setpoints**

The ITC’s battery charger factory setpoints are for wet batteries. Do not use GEL type batteries without changing the factory setpoints via the configuration switches.

**CAUTION!!**

**Do not operate DC loads, such as DC lights, pumps, etc., during battery charging. The loads may cause overcharging by preventing the charging stages from reaching their “trigger points” or may cause the battery to run down even though the charger is ON.**

**Battery Charger Factory Setpoints**

	Guideline	SP00172 24V	Factory Setpoint (for Wet Battery)		Factory Setpoint for Gel/AGM Battery		Units
			12V	24V	12V	24V	
Bulk Charge Volts		28.6	14.2	28.4	14.1	28.2	VDC
Bulk Charge Current	20% C Rate	60	80	60	80	80	Amps
Absorption Charge Volts		28.6	14.5	29.0	14.2	28.4	VDC
Absorption Charge Current		55	40	55	40	40	Amps
Absorption Maximum Time		10	10	10	10	10	Minutes
Float Charge Volts		26.6	13.2	26.4	13.7	27.4	VDC
Equalize Volts	Wet only	N/A	15.5	31.0	N/A	N/A	VDC
Equalize Maximum Time	Wet only	N/A	15	15	N/A	N/A	Minutes

Battery “C Rate” is equal to battery Amp Hour capacity.

**4-3.3.6 Battery Temperature Sensor Option**

The battery temp sensor is designed to reduce the float voltage when the battery temperature exceeds 25° Celsius. No reduction in float voltage should occur below 25°C (77°F). The battery temp sensor plugs into P7, which is located on the left side of the control board. See *F 13 Figure 6 - Customer Terminations*. The battery temperature sensor and 35’ cable kit part number is ITC-BTS. Individually, the temperature sensor part number is D012684 and the cable part number is D012638.

**4-3.3.7 Automatic Power Management (APM)**

A key feature of the battery charger operation is Automatic Power Management (APM). This feature monitors the AC input current and will reduce the battery charger output as necessary to keep the AC input current under the APM setpoint. The APM circuit will not limit power to the passthrough AC loads. If the passthrough AC loads exceed 30 Amp, the battery charger output will be reduced to zero and the breaker may trip.



### 4-3.3.8 GenStart

It should be noted that the Generator Start Operation is designed to minimize the generator run time, so at the preset set points there is no Absorption stage per se. Therefore, the batteries must be periodically conditioned by leaving the generator on, or charging them with another system.

The GenStart feature is designed for use in installations where a generator is used to provide AC input power for battery charging. The GenStart feature provides a contact closure to signal the generator to start when battery voltage falls below the "Generator Start Volts" 12.5 (25.0) VDC setpoint. The GenStart contacts open when bulk charging current fall below the "Generator End Amps" 20 Amp DC setpoint. The Bulk charging current is checked every 4 minutes, therefore the minimum generator ON time is 4 minutes. The contact are NEC Class 2, rated 2 amps at 24 VDC.

It should be noted that the GenStart contacts are shown in Figure 6 - Customer Terminations, and likewise a similar set of Normally Open Contacts are available to indicate a "Low Battery" or "Fan On" condition.

**CAUTION!!**

The battery charging process will be affected if 12 (24) VDC loads are being powered during battery charging. The increased charger output, required to power those loads, may keep the charger from reaching the "Generator End Amps" setpoint.

### 4-3.3.9 Charger and APM Programming

The chart below shows the control switch settings for programming the ITC Charger and APM settings.

**NOTE:** It should be noted that the power switch on the front of the unit must be cycled to read in the new Control Switch settings into memory. The new vales will not be recognized until this takes place.

The first 4 (1-4) switches program in the Maximum Charger Current and the next 4 (5-8) program in the APM Current Limit.

The next switch (switch 9) is for selecting either Wet or Gel type batteries.

The next switch (switch 10) is reserved for future expansion.

The next switch (switch 11) is reserved for future expansion.

The next switch (switch 12) is reserved for selecting a Master/Slave remote with multiple Control/Display Units.

**NOTE:** The figure on next page may be available on the Rear of the Control/Display Unit depending on model.

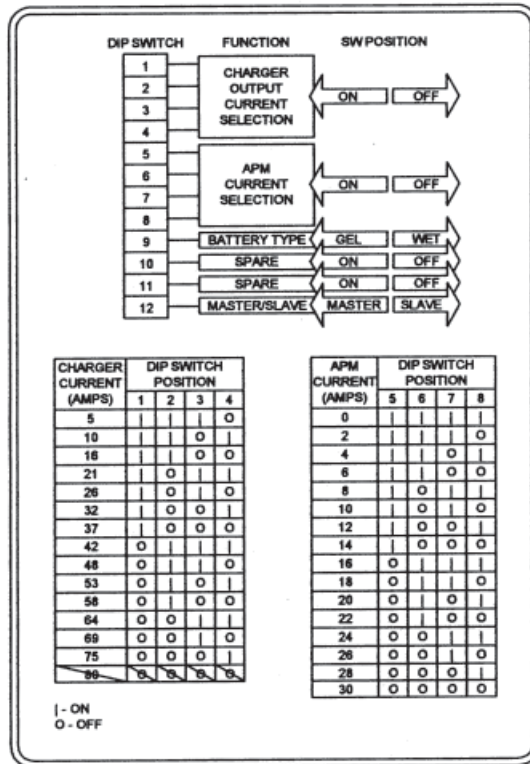

**NOTE:** After a new switch setting is set, the power switch must be cycled on the main unit for the new setting to take effect.

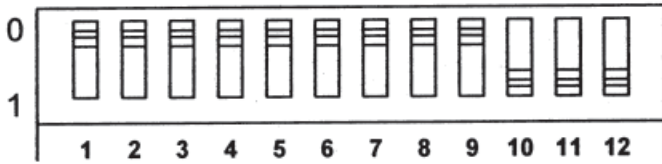

The graphic to the left indicates the factory defaults. Switches 1 through 4 show a maximum charger current setting. Switches 5 through 8 indicate 30-amp automatic power management. Switch 9 has selected West Cell battery configuration. Switch number 12 indicates "Master" display/control unit.

Figure 5 - APM/Charger/Config DIP Switch Settings

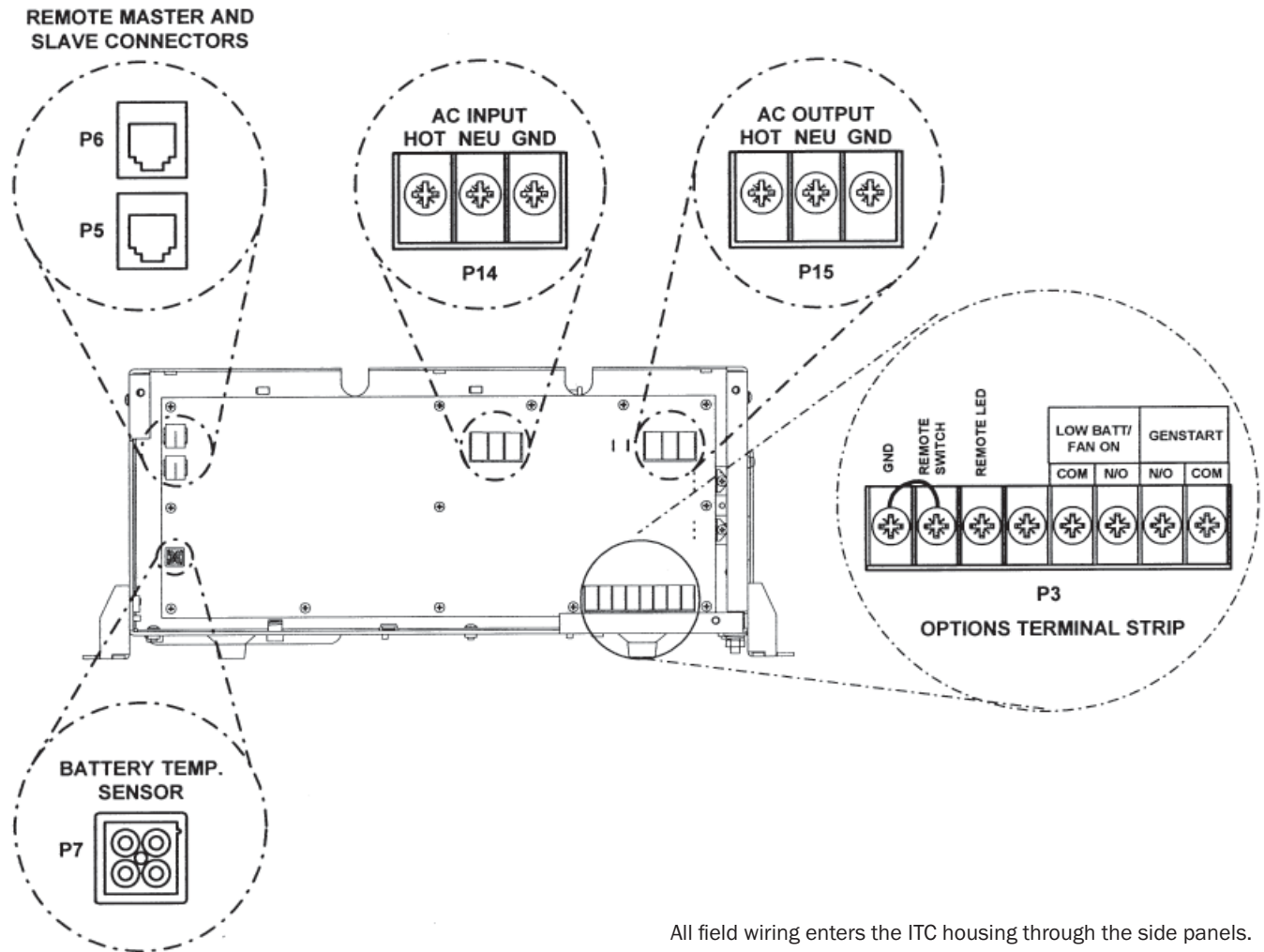

All field wiring enters the ITC housing through the side panels.

Figure 6 - Customer Terminations

## 4-3.4 Customer Wiring Identification

### 4-3.4.1 AC Input & Output Wiring

The AC wiring compartment is located on the front right side of the unit. A removable access cover covers this compartment. Two cable clamps are installed for the AC input and the AC output wiring. The removable access cover can be removed by simply removing the screws on the front panel of the unit (ONLY!). There is no need to remove screws from the top or sides of the unit to gain access to the AC wiring compartment. Inside the compartment is a terminal strip for making AC input and AC output connections (P14 and P15).

**NOTE:** The AC output voltage and the *required* AC input voltage of the ITC is 120 VAC, 60Hz.

### 4-3.4.2 DC (Battery) Wiring

A DC wiring compartment is located behind the wiring panel on the right side of the unit. The compartment contains a removable access cover on the top of the inverter and two cable clamps for the battery positive and battery negative cables. The inverter's battery cable terminal studs are 5/16-18 and can accommodate Cable sizes up to 250 MCM.

### 4-3.4.3 Front Panel Control/Display Outlet

This is a RJ-11 (6-Wire) jack (P5) for communications with the Control/Display Unit. A secondary Control/Display unit can be plugged into the P6 jack who would be configured as a slave.

### 4-3.4.4 System ON/OFF Switch

Use this rocker switch to turn the system ON and OFF and to reset the system. This switch is located on the front panel of the system. If placed in the "OFF" position, this switch will override the operation of a remote ON/OFF switch connected to terminals 7 and 8 of the Options connector shown in Figure 6 - Customer Terminations.

**WARNING!!**

**The System ON/OFF Switch does not interrupt the DC input power to the system, so it must be noted that dangerous DC voltages still exist inside the unit, even if the power switch is turned off.**

### 4-3.4.5 Remote Signal Contacts

Terminal Contacts provide capabilities for Remote Inverter Power ON/OFF and Power indication, Remote Low Battery Warning or Fan On indication, and GenStart control. Contacts are rated 2 amps at 24 volts. Class 2 circuits. Wiring connections are made through an 8 position Options terminal block. Screw pressure-clamp terminals accept up to 14-gauge wire.

A remote power switch will control the system by tying terminals 7 and 8 of the options connector (shown in Figure 6) together. This will actuate an internal relay that turns the control power on. The Power On/Off switch on the front panel defeats this remote switch.

In addition, a terminal for a remote LED indicator is provided (terminal 6) with a current limiting resistor integral to the circuit.

## 4-3.5 General Information

### 4-3.5.1 Generic Inverter Description

In general, an inverter converts DC electrical power into AC power. This power can be used to operate various AC-driven appliances. Typical DC power sources include batteries that store electrical energy, power generated from a vehicle alternator or renewable energy sources such as photovoltaic (solar) panels both with the appropriate regulator or charge controller to bring the DC source within the operating range of the inverter.

The most common battery systems are 12 or 24 volt. Some systems, however, operate on higher voltages such as 32, 36, 48, or 120 volts. The most common inverter AC output power is 120 volts at a frequency of 60 Hz. Some inverters, however, are designed to produce 240 volts, or both 120 and 240 volts at 60 Hz. Because some countries use power of different voltage and frequency (e.g., 230 volts at 50 Hz), inverters are available to conform to these requirements.

There are three available inverter types and they are distinguished by the type of AC output wave form they produce. Below is a graphic of the three types of inverters. The coach is supplied with a true Sine Wave Inverter.

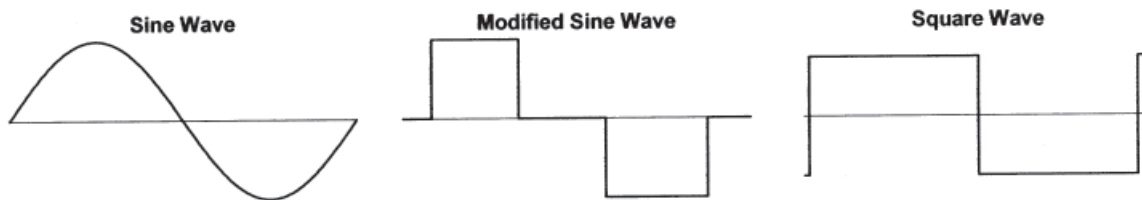

#### **Sine Wave Inverter**

Sine Wave Inverters produce an AC output waveform like power produced by the electric utility companies and rotating generators. The sine wave inverter's waveform is characterized by the highest peak voltage and smooth voltage transitions (no square wave components). Such inverters are the most costly of the three inverter types because they contain additional electronics to produce the required waveform. A measure of the sine wave quality is Total Harmonic Distortion (THD), and is expressed in a percentage. The lower the THD the higher the quality of the sine wave power.

#### **Modified Sine Wave Inverter**

Modified Sine Wave Inverters are sometimes called "quasi sine wave inverters" or "modified square wave inverters." Modified sine wave inverters generally cost more than square wave inverters because they contain additional electronic circuitry to produce true RMS regulated AC output. Modified sine wave inverters have higher AC peak voltages than square wave inverters, and automatically control the width of the AC output waveform to regulate the output voltage (pulse-width modulation). The shape of the modified sine wave inverter's waveform includes a square wave component. It is stepped in such a way, however, to closely approximate the true sine wave produced by the electric utility companies. Although this waveform has a higher peak voltage than do square wave inverters, its peak voltage is not as high as a pure sine wave. Therefore, AC loads containing power supplies might not always operate properly on the modified sine wave inverter.

#### **Square Wave Inverter**

The Square Wave Inverter is a low cost device that produces a pure square wave AC power output. This AC power can be an accurate 60 Hz frequency if it is crystal controlled. It does not have the necessary peak voltage to properly operate many AC appliances that contain electronic power supplies (e.g., computers, TVs, and VCRs). The square wave is appropriate when operating AC loads such as resistive heating devices.

## 4-3.6 Maintenance and Troubleshooting

### 4-3.6.1 Preventative Maintenance

There are no user serviceable components inside the ITC-Series Inverter/Charger. For service refer to Vanner Incorporated or your Blue Bird Coachworks service department.

#### Maintenance Items:

For continued reliability and safety, a monthly maintenance program should be implemented to include the following:

1. Check to insure that all AC and DC wiring is secure and connections are tight and corrosion free.
2. Check air ventilation openings for dust and other obstructions.
3. Examine receptacle, indicators and switches for cracks and breaks in insulation material.

### 4-3.6.2 Troubleshooting

The Unit does not come on when Shore Power or DC is applied and the front Power Switch is on.

#### Suggestion:

Make certain that the remote switch connected to Options Terminal Strip P3 - terminals (Remote Power Switch P3-7 - To Ground P3-8) is functioning properly. If the switch is not installed, make certain that a jumper is present between the two left most terminals (GND and Remote Switch) as shown below.

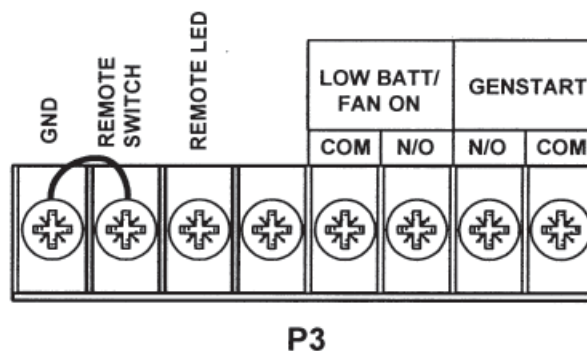

Figure 8 - Options Terminal Strip

## 4-4 Battery Systems

The battery system is comprised of two chassis (engine) batteries and eight house batteries, located in the last bay curbside of the coach. There is also a generator battery that is located in the nose of the coach next to the generator. Batteries are described below:

### 4-4.1 Chassis (engine) Batteries

Two 12-volt maintenance free 810 CCA batteries wired parallel produce power for starting the motor home engine.

### 4-4.2 Battery Charger

One 160-Amp battery charger (integral with the Vanner inverter) operates when a source of 120 volts of AC is supplied from either shoreline or generator. The charger is connected to the motor home batteries. Enabling the auxiliary battery switch on the lower dash may also charge the engine batteries.

### 4-4.3 Generator Battery

A separate 12V rated at 530 CCA battery is installed for starting the generator. This is located in the nose of the coach right next to the generator.

### 4-4.4 House Batteries

The house battery system consists of eight Lifeline 4D AGM batteries with an Amp-Hour rating of 210 alt each.

With the Lifeline batteries you get:

- Aircraft class cell construction:
  - » Lowers internal resistance for high repeated engine start current.
  - » Withstands shock and vibration much better than standard flooded or gelled electrolyte designs.
- Twice as many discharge/charge cycles as the leading gel battery depending on depth of discharges.
- Faster recharge, no current limitations with voltage regulated recharging
- Much better charge retention than low cost, flooded cell types, even at high ambient temperature.
- Full recharge after 30 days storage in a full discharge condition (77 °F rating).
- Less than 3% per month self discharge at 77 °F (25 °C); less at lower temperatures.
- Sealed construction with absorbed electrolyte-no shipment restrictions, submersible without damage; install in any position; no need for watering.
- Cell safety vent valves-pressure regulated, non-removable.
- Rugged, non-marring polypropylene (copolymer) case/cover.
- Safety-even during severe overcharge the Lifeline AGM battery produces less than 2% hydrogen gas (4.1% is required for flammability in air)

### Deep Cycle Batteries Specifications

PART NUMBER	NOM VOLTS	OVERALL DIMENSIONS			UNIT WT Lbs. (Kgs)	CCA 68 °F	CCA 32 °F	CCA 0 °F	CAPACITY AMPERE HOURS @20 HR. RATE	MINUTES OF DISCHARGE@		
		L in (mm)	W in (mm)	H in (mm)						25 AMPS	15 AMPS	8 AMPS
GPL-U1T	12	7.71 (196)	5.18 (132)	6.89 (175)	24 (10.9)	325	275	215	33	50	93	185
GPL-24T	12	11.13 (283)	6.77 (172)	9.25 (235)	56 (25.5)	800	680	550	80	149	259	524
GPL-27T	12	13.09 (333)	6.77 (172)	9.25 (235)	65 (29.5)	845	715	575	100	186	324	655
GPL-31T	12	12.90 (328)	6.75 (172)	9.27 (236)	69 (31.4)	880	750	600	105	195	340	688
GPL-4DA	12	20.75 (528)	8.71 (222)	10.09 (257)	135 (61.2)	1595	1360	1100	210	390	680	1375
GPL-4DL	12	20.75 (528)	8.71 (222)	10.44 (266)	135 (61.2)	1595	1360	1100	210	390	680	1375
GPL-8DA	12	20.72 (527)	10.94 (278)	9.88 (251)	162 (73.6)	1975	1675	1350	255	475	825	1670
GPL-8DL	12	20.72 (527)	10.94 (278)	10.23 (260)	162 (73.6)	1975	1675	1350	255	475	825	1670
GPL-4C	6	10.27 (261)	7.12 (181)	11.54 (294)	66 (30.0)	1095	925	750	220	492	856	1692

Terminals: GPL-24T, GPL-27T & GPL-31T are heavy duty silicon-bronze Marine Terminals and the GPL-U1T is a 6mm copper alloy threaded insert. All "T" batteries supplied with brass bolts and washers. A=Automatic Post. L=L bladed terminal 8mm bolt hole and supplied with bolts and washers. Handles: "T" models-Handles are built into cover design. GPL-24T and GPL-27T also incorporate strap handles. Handles not available on part numbers GPL-4C and GPL-31T. Models GPL-4D & GPL-8D are equipped with rope handles. Ratings: Capacity ratings are stated at 77 °F (25 °C) to 1.75 volts per cell. Drawings: Product drawings for each model available upon request.

### Starting Batteries Specifications

PART NUMBER	NOM VOLTS	OVERALL DIMENSIONS			UNIT WT Lbs. (Kgs)	CCA 68 °f	CCA 32 °F	CCA 0 °F	CAPACITY AMPERE HOURS @20 HR. RATE
		L in (mm)	W in (mm)	H in (mm)					
*GPL-1400T	12	9.78 (249)	5.17 (132)	5.83 (174)	32 (14.5)	850	700	550	57
*GPL-2400T	12	11.13 (283)	6.77 (172)	9.25 (235)	53 (24.1)	870	790	650	75
*GPL-2700T	12	13.09 (333)	6.77 (172)	9.25 (235)	63 (28.6)	1020	900	745	95
*GPL-3100T	12	12.90 (328)	6.75 (172)	9.27 (236)	67 (30.4)	1120	950	810	100

Ratings: Capacity ratings are stated at 77 °F (25 °C) to 1.75 volts per cell.

Drawings: Product drawings for each model available upon request.

**\*NOTE: These are starting batteries only. SPECIFICATIONS SUBJECT TO CHANGE WITHOUT NOTICE.**



## 4-4.5 Split Battery Power System

The coach is run by house and chassis batteries. The Battery Connect/ Battery Disconnect switch connects and disconnects the house and chassis batteries.

## 4-4.6 Battery Maintenance

Your motor home is equipped with separate engine and house battery systems for greater assurance that there will be sufficient voltage to crank the motor home engine.

The two engine batteries and the eight house batteries are all located in the last bay curbside of the coach.



The house and engine batteries are charged from either the alternator or the inverter battery charger. The auxiliary battery switch is in the ON position in order for the inverter battery charger to operate, either the generator must be running or the motor home must be connected to a shoreline supply.

To make sure that the batteries are always ready for use, periodically check and charge them as necessary.

A dirty battery may eventually dissipate its charge through conductive surface contamination. Clean the engine battery top surfaces with a damp cloth and dry thoroughly. Check that battery terminals and associated battery jumper terminals are tight and free of corrosion. To clean terminals, neutralize corrosive deposits with a solution of baking soda, rinse with clear water, and dry. Note that commercial type spray-on battery cleaners are available at automotive supply stores. Use as directed to keep the batteries clean. Spray-on cable and terminal protective coatings are also available, easy to use, and effective.

**CAUTION!!** Avoid sparking of any form in the vicinity of the batteries.

**CAUTION!!** Do not wear metal rings, watches or jewelry when working on or near the batteries, cable, solenoids or chassis wiring. These can short out electrical wiring and cause injury.

## 4-4.7 Battery Storage in Freezing Weather

Batteries that are not kept fully charged must be given protection against freezing. Partially charged batteries will freeze at low temperatures, so batteries must either be left charged or removed from the vehicle and stored in a warm location. The motor home can be left connected to the shoreline AC supply and the inverter battery charger will keep the motor home batteries charged.

**NOTE:** The inverter must be turned on to charge the batteries.

**NOTE:** Even in a warm location it is advisable to keep the batteries charged to prevent deterioration. The engine batteries are the sealed type and require no electrolyte service.

Coat battery terminals with lubricant or protective coating.

## 4-4.8 Battery Terminals and Jump Starting

The proper procedure for jump-starting, using the Wanderlodge® engine batteries, is as follows:

1. Turn off all main battery-operated accessories in both vehicles such as the lights, radio, etc.
2. Connect one end of the positive-coded jumper cable to the positive (+) battery terminal, and the opposite end of the cable to the positive (+) terminal on the other battery.
3. Connect one end of the negative-coded jumper cable to the negative (-) terminal on the other battery and the opposite end of the cable to the Wanderlodge engine block.
4. Once the engine of the disable vehicle is started and brought up to idle, reverse the above procedure to remove the jumper cables. Always remove the jumper cable connected to the engine block terminal first to prevent sparks at the other battery.

**CAUTION!!** Avoid sparks in the vicinity of a charging battery. The gas produced is explosive.

## 4-5 Leveling System

### 4-5.1 Introduction

#### 4-5.1.1 What it Can Do

Your motorhome is equipped with a Hadley Air Leveling System which has two operational modes: Ride Mode and Parked Mode. The Ride Mode uses the Hadley Smart Air Management System (SAMS). The Parked Mode uses the Hadley Self-Leveling System (SLS). This microprocessor based system controls the inflate/deflate operation of the individual suspension air bags in accordance with the respective operational mode.

The Ride Mode, SAMS, is selected when the Park Brake is released. This mode automatically adjusts the ride height when the Ignition switch is ON and the engine driven air compressor is running.

With SAMS, the user can change the vehicle height by selecting one of several predetermined settings from the operator's control panel. This is useful when departing from a steep driveway; the rear end can be raised to increase the departure angle.

With SAMS, the user can also inflate/deflate the tag axle air bags when the vehicle is stationary or is traveling at slow speeds. By deflating the tag axle air bags, the turning radius can be reduced or additional traction can be transferred to the drive axle.

The Parked Mode, SLS, is selected when the Park Brake is engaged. This allows the user to level the vehicle when parked on an uneven surface. After the vehicle is leveled, the SLS can be placed into the Standby Mode to reduce House battery drain.

The transition from the Parked Mode to the Ride Mode occurs when the Park Brake is released. The vehicle attains ride height within 5-10 seconds after the engine is started.

#### 4-5.1.2 What it Cannot Do

Many of the user settings are available only when operating below certain speeds or when the parking brake is applied.

#### 4-5.1.3 User Interface

The Hadley operator's panel is located on the left side of the driver position. The user has the ability to select the predetermined ride height settings, SLS functions, and tag axle control. The indicator lights provide feedback to the operator.

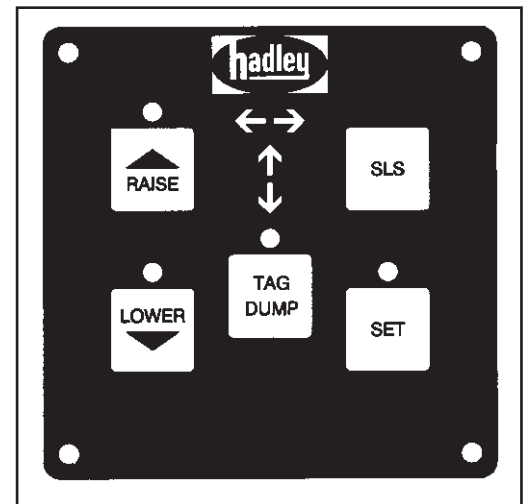

Leveling Operator's Panel

## 4-5.2 Operation Instructions

### 4-5.2.1 Location of Raise, Lower and Tag Axle Buttons and Indicator Lights

#### Ride Mode - Raise, Lower, and Tag Control

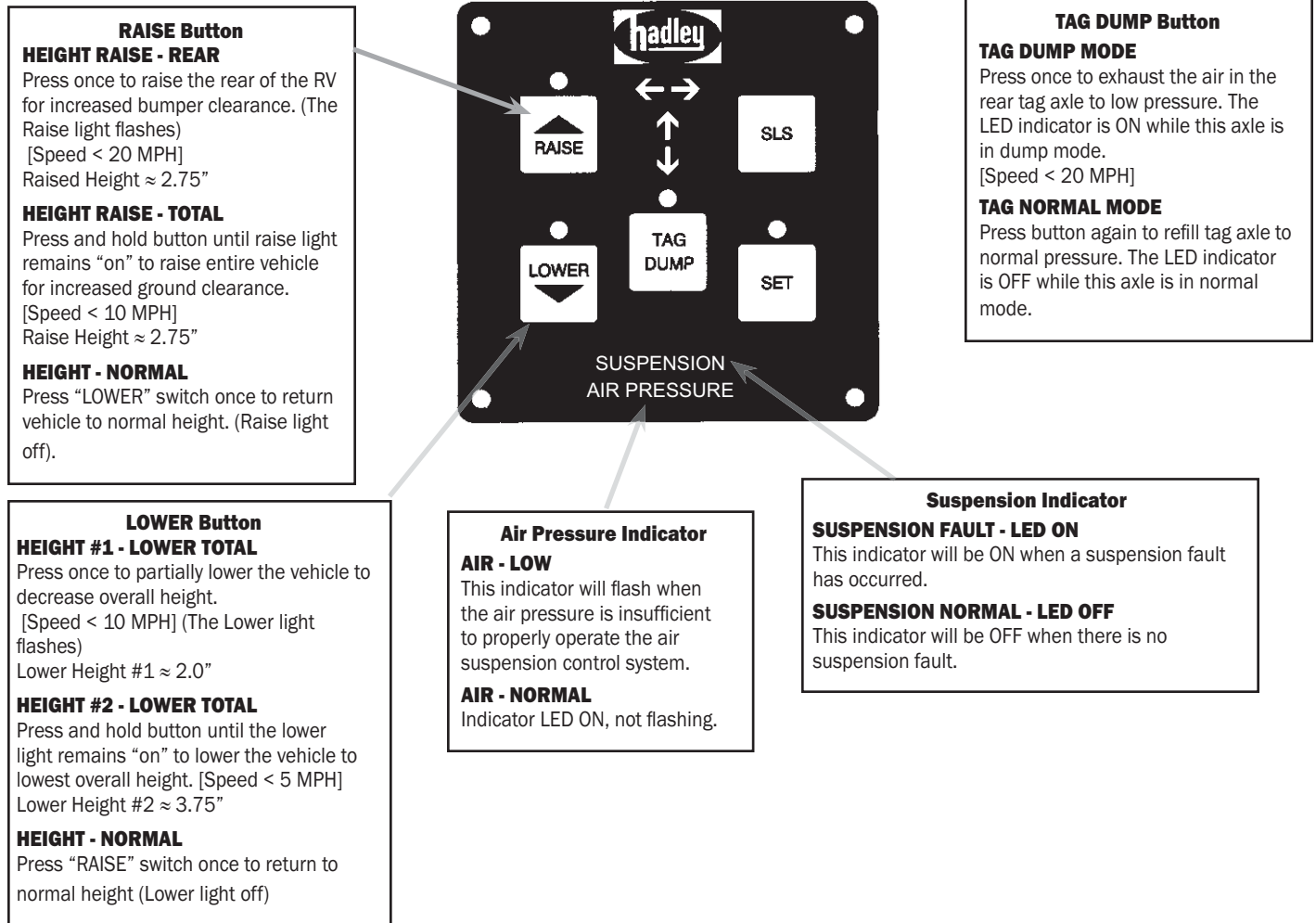

## Parked Mode Buttons and Indicators

**Note:** The “Level Find Mode” is used to help locate a level surface on which to park before the SLS “SET” button is used.

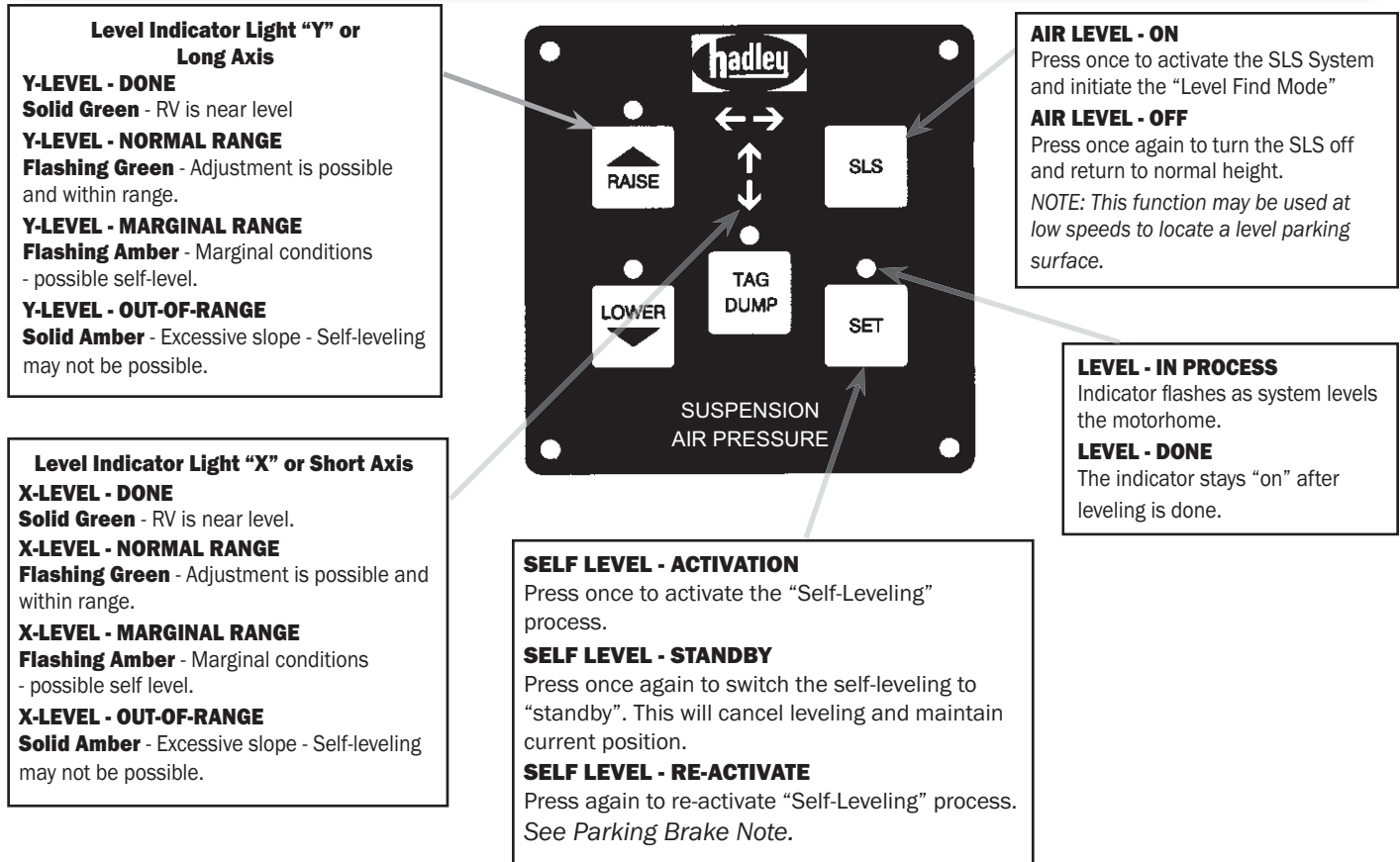

## SLS Control Functions and Indicators

**Note:** The parking brake must be applied before the SLS “SET” feature can be used.

### 4-5.2.2 Power ON

When the vehicle is first turned on, the Hadley SAMS will gather information from the sensors. This period of time will be approximately 5 seconds. The system will not make any adjustments during this time. See the troubleshooting section if the Suspension Light stays on or starts blinking.

## 4-5.3 Hadley SAMS Pressure Requirements - Ride Mode

### 4-5.3.1 Switch ON

Electrical power must be “ON” and system air pressure above 90 PSI.

**WARNING!!**

Failure to operate the vehicle without sufficient air pressure may cause vehicle damage or personal injury.

### 4-5.3.2 Switch OFF

The electrical power must be switched “OFF” when jacking, hoist towing or during designated service procedures.

**WARNING!!**

Failure to power off electrical system power and release air pressure may cause vehicle damage or personal injury.

## 4-5.4 Ride Height Mode Definitions

### 4-5.4.1 Normal Ride Height

This is the standard height for the vehicle during normal driving operation.

### 4-5.4.2 Raised Mode

The vehicle is raised to increase the clearance between the ground surface and the underside of the frame. The vehicle can be raised approximately 2.75 inches.

### 4-5.4.3 Lowered Mode

The vehicle is lowered to increase clearance above the vehicle. This mode will reduce the clearance between the ground and the vehicle frame. By pushing the Lower Button once, it will lower vehicle approximately 2.0 inches. If Lower Button is held down vehicle will lower approximately 3.75 inches.

### 4-5.4.4 Tag Dump

This button controls the air pressure in the tag axle air bags. This feature allows the user to reduce load on the rear axle to decrease turning radius and improve maneuverability. The dump feature is also used to increase traction on the drive axle.

### 4-5.4.5 Vehicle Height Change Procedures

**IMPORTANT: The vehicle’s engine should be running when changing heights. This allows the vehicle to provide sufficient air supply to the air suspension system.**

### 4-5.4.6 Normal Driving Mode to Raised Rear Mode

Press the “Raise” button once to enter the “Raise Rear Mode”. This mode is used to increase the clearance between the bumper and the ground.

The “Raise Rear Mode” may be activated at speeds up to 20 MPH, the vehicle will return to normal ride height mode when your speed exceeds 20 MPH or if the “Raise Rear Mode” has been on for more than 40 seconds.

The “Lower” button may be pressed once to return to the normal ride height mode.

### 4-5.4.7 Normal Driving Mode to Raise Mode

Press and hold the “Raise” button (about 3 seconds) until the indicator remains “on” to activate the “Raise Mode”. This mode is used to increase the clearance between the entire vehicle and the ground.

The “Raise Mode” may be activated at speeds up to 10 MPH, the vehicle will return to normal ride height mode when your speed exceeds 10 MPH or if the “Lower button” is pressed once.

### 4-5.4.8 Normal Driving Mode to Lower Mode

Press the “Lower” button once to enter the “Partial Lower Mode”. This mode is used to decrease the overall height of the vehicle to clear obstructions.

The “Lower Mode” may be activated at speeds up to 10 MPH, the vehicle will return to normal ride height mode when your speed exceeds 10 MPH or if the “Raise” switch is pressed once.

### 4-5.4.9 Normal Driving Mode to Full Lower Mode

Press and hold the “Lower” button (about 3 seconds) until the indicator light remains “on” to activate the “Full Lower Mode”. This mode is used to decrease the overall height of the vehicle to minimum to clear obstructions.

The “Full Lower Mode” may be activated at speeds up to 5 MPH, the vehicle will return to normal ride height mode when your speed exceeds 5 MPH or if the “Raise” button is pressed once.

### 4-5.4.10 Tag Dump Mode

The “Tag Dump” button controls the air pressure in the tag axle air bags. This feature allows the user to reduce the load on the rear axle to decrease turning radius and to improve maneuverability. This feature is also used to increase traction on the drive axle.

When the “Tag Dump” is active and the speed is less than 12 MPH, the system will reduce the tag axle pressure from normal pressure to about 5 PSI, if the speed increases above 12 mph the tag axle pressure will increase to about 30 PSI, when above 20 mph the tag axle will return to normal operating pressure and the “Tag Dump” mode indicator will switch off.

The “Tag Dump” button can be pressed at any time to either activate or switch off the “Tag Dump Mode”.

## 4-5.5 SLS/SET Controls - Parked Mode

The “SLS” and “Set” buttons are used to control the self leveling feature.

The SLS button is used to activate the system and two indicator arrows located to the left of the SLS button.

The SLS feature can be turned on when operating at slow speeds to help find a level location (“Level Find Mode”).

Refer to the information on page 6 regarding the arrow indicators.

Note: The “Set” button activates the self leveling feature. The SLS system must be switched ON and the parking brake applied before the “Set” button can operate.

The “Set” command levels the RV by first adjusting the “Y” axis and then adjusting the “X” axis. The “Set” indicator flashes while the RV is leveling and then stays “ON” when the leveling is complete.

By pressing the “Set” button after leveling is complete, the SLS is placed into “Standby” State. The “Standby” State disables the automatic leveling process and reduces the battery power consumption.

## 4-5.6 Roadside Emergencies and Service

### 4-5.6.1 Jacking or Towing

The electrical power to the Hadley SAMS system must be turned OFF whenever jacking or towing this vehicle.

### 4-5.6.2 Tire Replacement

The electrical power to the Hadley SAMS system must be turned OFF whenever jacking or towing this vehicle.

See **Towing Section** for instructions on how to tow the motorhome.





## 4-6 Awning Operation

Your motor home comes equipped with three manual awnings, a patio awning, a slide-out awning and a window awning. Zip Dee, Inc manufactures all three. An optional power awning can be purchased for the patio awning, which is manufactured by Girard RV Products, Inc. See below for basic operation of these awnings.

### 4-6.1 Manual Awning Operation with Clamp Wheels

#### 4-6.1.1 Opening

1. Insert the pull rod behind the Z-Lock lever and pull downward (Fig. 1A). This releases the awning. Then turn the clamp wheel counterclockwise and swing the assembly toward the center to free the hardware (Fig. 1B).

**NOTE:** Leave Z-Lock open when awning is open to avoid damage.

2. Insert the pull rod into the loop of the center control strap and unroll the awning by pulling it toward you (Fig. 2). Step under the awning and fold or roll the control strap toward the backside of the roller and tuck under restraining strap.

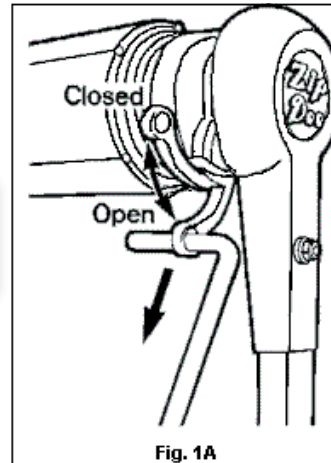

Fig. 1A

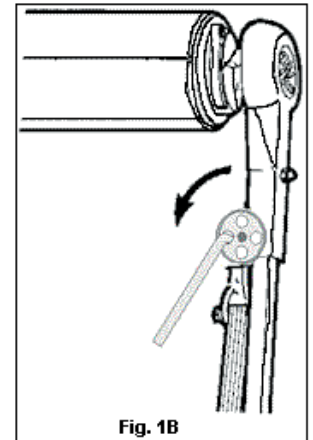

Fig. 1B

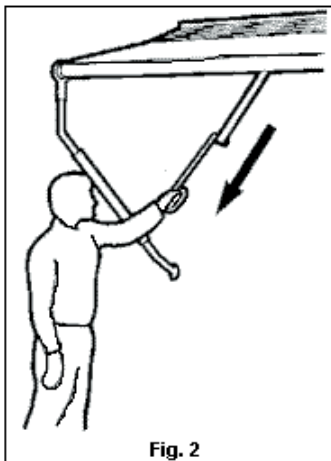

Fig. 2

3. Release the rafter arm by pulling outward on the cap of the ratchet stud located on the upper portion of the arm (Fig. 4). Extend the arm and place the claw over the shaft of the roller.

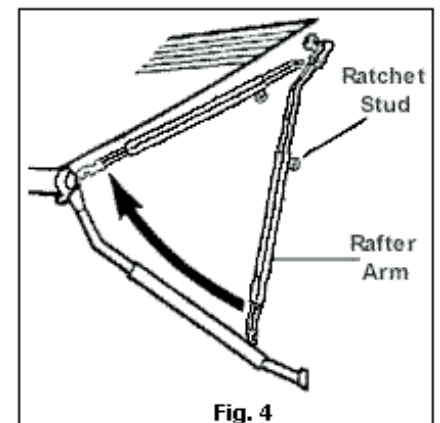

Fig. 4

4. Set the spring tension of the rafter arm by grasping the outer tube and pushing briskly forward in the direction of the arrow as shown in Fig. 5 until a click is heard indicating the arm is locked. At this point the awning fabric will be taut.

**NOTE:** Leave Z-Lock open when awning is open to avoid damage.

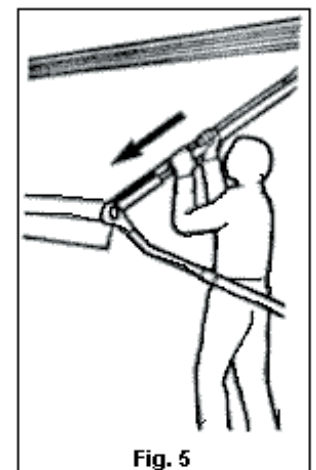

Fig. 5

5. Raise the awning to the desired height by releasing the snap stud on the main arm and pushing up and outward on the roller assembly (Fig. 6).

REPEAT STEPS 3-5 FOR THE OTHER END OF THE AWNING.

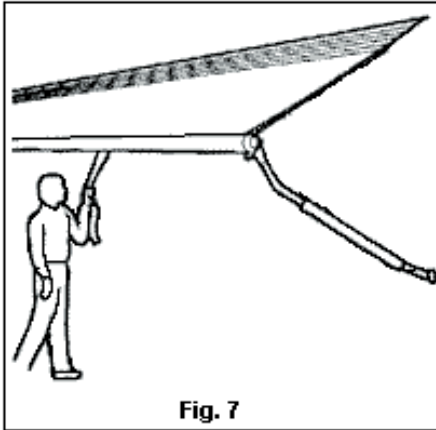

Fig. 7

### Partial Extension or “Caravan” Position

1. Follow Steps 1 and 2 above.
2. Insert the pull rod in the loop of the center control strap and unroll the awning to the desired extension (Fig. 7).
3. To prevent billowing, hook the claw of the unextended rafter arm over the roller shaft (Fig. 4). This will require the awning be extended approximately four and one half feet.
4. Raise the awning to the desired height by following step above.

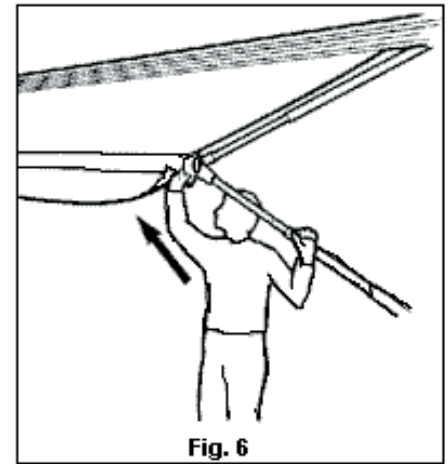

Fig. 6

## 4-6.1.2 Closing

1. Release the snap stud of the main arm and lower the awning.
2. Release the ratchet stud on the rafter arm by pulling outward on the cap. Lift the claw from the roller shaft and place it on the height adjustment stud located on the inside of the main arm. This allows a “scissors-like” action that helps guide the arm upward.
3. Repeat steps 1 and 2 for the other end of the awning.
4. Face the awning and hold the end of the control strap firmly in one hand then push the roller up briskly with a rolling motion until you feel the spring take over. Control the speed by holding the control strap and let the awning roll freely the rest of the way. This additional force will help tighten the fabric around the roller for the tightest, neatest appearance.
5. Lock the awning in place by reversing Steps 1 and 2 of the opening procedure (Figs. 1A and 1B).

**NOTE:** If you don't have clamp wheels (Fig. 1B), see Universal Operation later in this manual.

## 4-6.2 Universal Awning Operation

### 4-6.2.1 Opening

1. Insert the pull rod into the Z-Lock lever and pull down (Fig. 8). This releases the awning.

**NOTE:** Leave Z-Lock open when awning is open to avoid damage.

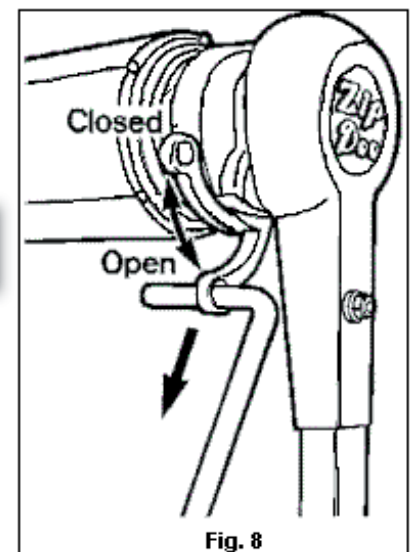
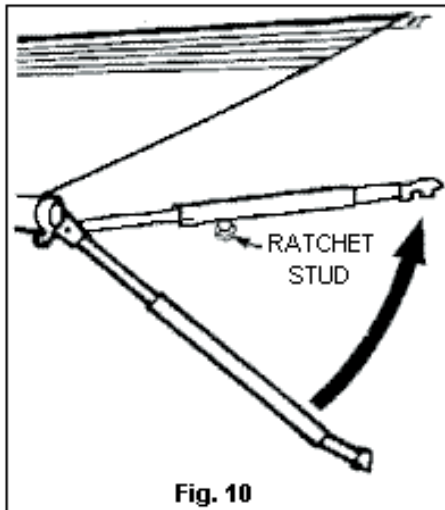
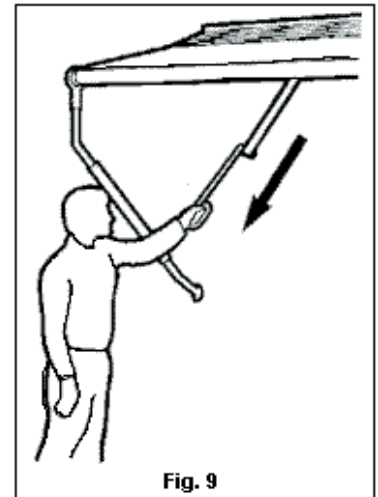
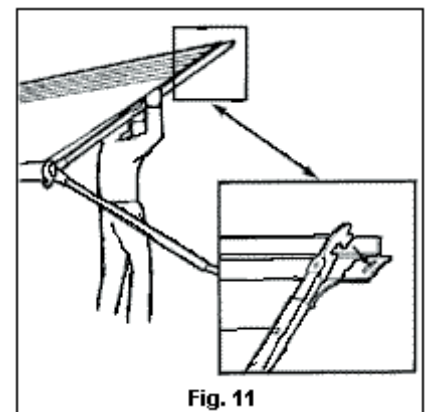

Fig. 8

- Insert the pull rod into the loop of the center control strap and unroll the awning by pulling it toward you. (Fig. 9). Step under the awning and roll or fold the control strap toward the backside of the roller and tuck under the restraining strap.



- Release the rafter arm by pulling outward on the cap of the ratchet stud. Raise the arm upward toward the case (Fig. 10). Extend the arm and set the claw shaped end into the slot of the rafter lock (Fig. 11).



- Lock the rafter arm in position by pressing down on the steel main arm bar (Fig. 12) until the ratchet stud clicks. At this point the fabric will be taut.
- Raise the awning to the desired height by releasing the snap stud on the main arm and pushing up and out on the roller assembly (Fig. 13).

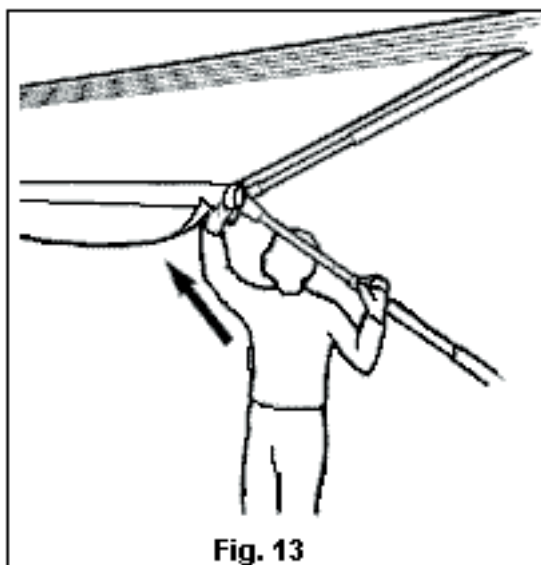
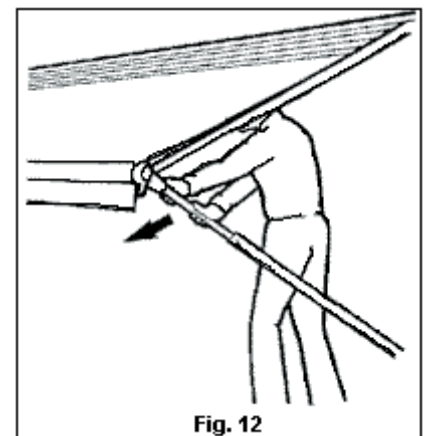

**NOTE:** Leave Z-Lock open when awning is open to avoid damage.

### Partial Extension or “Caravan” Position

1. Follow Step 1 on previous page.
2. Insert the pull rod in the loop of the center control strap and unroll the awning to the desired extension.
3. To prevent billowing, release and raise the rafter arm (Fig. 10) and hook the claw of the arm into the slot of the rafter lock (Fig. 14). This will require the awning to be extended approximately four and one half feet.
4. Raise the awning to the desired height by following Step 5.

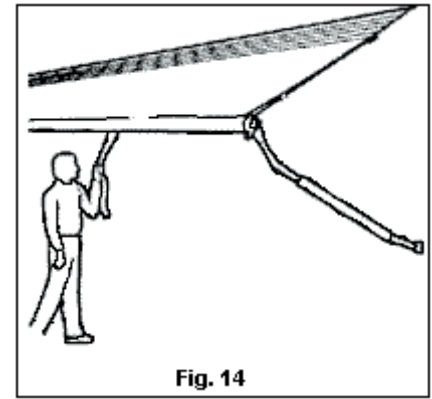

Fig. 14

### 4-6.2.2 Closing

1. Release the snap stud of the main arm and lower the awning to its bottom most position.
2. Release the ratchet stud of the rafter arm and lift the claw out of the rafter hook.
3. Place the claw casting on the protruding height adjustment stud. To lock the assembly in a travel position, push the other tube downward until the ratchet stud snaps closed. Repeat Steps 1-3 for the other end of the awning.
4. Face the awning and hold the end of the control strap firmly in one hand. Push the roller briskly upward with a rolling motion until you feel the spring take over. Control the speed of closure by holding the control strap until all but 6 inches of the fabric has rolled up. Release the strap and let the awning roll freely the rest of the way. This extra force will help tighten the fabric around the roller to insure the tightest, neatest appearance.
5. Lock the awning in place by flipping the Z-lock lever into the “closed” position using the pull rod.

### If Awning Rolls Up Uneven

Observe if the roll-up is even and in line with the clamps (if any). If not, then unroll the awning and give the roller a slight push towards the direction it should go. If you wish to have the awning roll up more in either direction, then spiral the pull strap in that direction.



**NOTE: The strap must be spiraled around the roller. This prevents a loose roll and bunching of the fabric.**

### How to Adjust Spring Tension

There is only one spring, located at the rear end of the awning. The winding procedure uses the main arm bar as a lever, since the spring is connected to the bar through the roller shaft and head casting.

1. Open the Z-Lock lever(s) carefully and allow the awning to open.
2. Support awning roller with ladder or with help of assistant.
3. Disconnect rear main arm from main hinge. Pull outward on snap stud and slide tube portion off from bar (to shorten arm for winding.)
4. Stand at the rear of awning facing front of vehicle and grasp main arm bar. Adjust the spring by winding clockwise to increase tension or counter-clockwise to decrease tension so that the open awning will not start to roll up until given a rolling start by hand of about 12 inches. This will eliminate the need to lock the awning open.

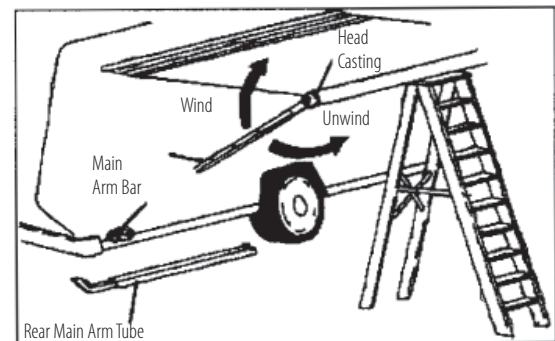

### WARNING!!

**The spring is under tension. Do not disconnect the bar from the head casting. The weight of the bar is enough to counterbalance the spring tension. Use of any other winding device could be dangerous if not controlled, resulting in personal injury or property damage.**

- After winding, slip the main arm tube back onto the bar and reconnect it to the main hinge on the vehicle and test the tension.

**NOTE: Leave Z-Lock lever (both ends) OPEN when awning is open to avoid damage.**

For proper rafter arm operation the ratchet stud must be correctly installed.

The ratchet stud screws into the tube using a 7/16" wrench and the flat side of the stud should face the end of the rafter tube.

The off center pin can be pushed up or down using pliers so the cap (and the pin that's attached to it) can be re-positioned.

**NOTE: The claw opening should face away from the motor home on "Universal Style" hardware and TOWARDS the motor home on "Contour Style" hardware.**

On contour hardware the ratchet stud should release easily from the counter sunk stop hole at the top of bar when opening awning.

### How to Repair a Bowed Roller

**NOTE: This can only be done if there is no crimp or kink in the 3" tube. If the tube is crimped, it is necessary to replace the tube.**

- Unroll the awning.
- The awning should be supported and held at both ends on the shoulders of two (2) individuals, see Fig. At left. Also, the awning should be walked in toward the motor home approximately one (1) foot, to provide slack in the fabric.
- Place the bow of the roller facing up.
- A third person should hang on the tube at the center point of the bow. Doing this gradually will remove the bow.
- To check for straightness, roll the awning up. If a wobble is present, further straightening is required.

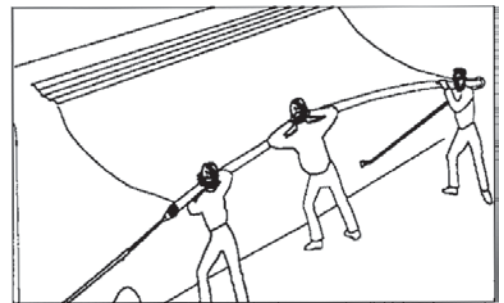

## 4-6.3 Hardware and Mechanism Maintenance

Although your Zip Dee awning requires less maintenance than any other awning, a little care (about the same amount that you give to your motor home) will keep the metal parts in top shape. The rafter arm assemblies, main arm tubes, and the awning case are anodized aluminum; the castings are high-strength aluminum alloys. To keep these parts new looking they should be cleaned once a year with a good quality non-abrasive chrome or aluminum polish.

The main arm bar and all fasteners and stress bearing shafts are stainless steel. These need only be cleaned occasionally to remove accumulated grime that might hinder their operation.

### At the end of each season:

- Tighten any loose bolts or screws (Replace missing parts only with factory authorized replacements).
- Clean accessible hardware with non-abrasive cleaner.
- Use a silicone lubricant only on the 1/2" round shafts that protrude from each end of the roller.
- Extend all telescoping arms as far as possible to wipe off accumulated sand and dirt that can clog and scratch the protective aluminum finish. No lubrication is required on those parts.

## Replacement Parts

Use only genuine Zip Dee replacement parts when repairs are needed. Use of substitutes may damage your awning or void your warranty. Parts may be ordered through your local Zip Dee dealer. If you need help, we are as close as your telephone or post office. Use the number and description found on the parts list in the Zip Dee booklet provided with your motor home when ordering parts and be sure to include the make, model and year of your vehicle. Warranty claims must include the damaged part. If you cannot remove the damaged parts with a replacement, you must purchase the part at full price and receive a refund (if the warranty applies) when we get the damaged part back. Take a moment to copy your hardware serial number and hardware code number from your front main arm tube here \_\_\_\_\_

All parts are sent COD unless your charge card number or check accompanies your order.

## 4-6.4 Optional Power Awning

If you purchased the optional power awning by Girard RV Products, Inc. below you will find the basic operation instructions for this awning.

### 4-6.4.1 Operating Instructions

The Girard G-2000 Lateral Arm Awning incorporates the very latest in technology and design. The box awning offers total protection in all weather and features the following advanced features:

- Convenient push button operation - optional remote control for the ultimate in state of the art convenience.
- Heavy duty, lateral arms eliminate clumsy, unattractive, side support arms. The angle of the arms is adjustable from 5 to 35 degrees for maximum comfort..
- Provides 25% more shade than traditional roll-up awnings. The 100% acrylic fabric is weatherproof, permeable to air, and resistant to mildew, rotting and fading.
- Equipped with a manual crank for operation in the event of power failures.
- Exclusive wind sensor system automatically retracts awning in the event of excessively high winds.

### 4-6.4.2 Crank Operation:



A hand crank is supplied with every awning and easily telescopes from 50 to 82 inches. Simply insert the end of the crank into the receiver, which is located at either the right or left side of the awning. Push up and rotate the handle one-quarter turn clockwise, then let the handle drop about a half-inch. You should then feel the handle lodge in the receiver. You are now ready to extend the awning.

To open the awning, rotate the handle in a counter clockwise direction. To close the awning, rotate in a clockwise direction. When extending awning to full extension, extend only until the elbowing arms “click” and lock themselves into place. Unrolling the awning further than this point will result in excessive slack in awning fabric. Additionally, when awning is rolled past full extension, the fabric can reverse from the bottom of the roller tube to the top of the tub. The

fabric must always roll from the bottom. If this should happen, simply crank the awning all the way out until the roller tube is exposed and continue cranking in the same direction. The fabric should then be rolling onto the bottom of the roller tube.

To open the awning, rotate the handle in a counter clockwise direction. To close the awning, rotate in a clockwise direction. When extending awning to full extension, extend only until the elbowing arms “click” and lock themselves into place. Unrolling the awning further than this point will result in excessive slack in awning fabric. Additionally, when awning is rolled past full extension, the fabric can reverse from the bottom of the roller tube to the top of the tube. The fabric must always roll from the bottom. If this should happen, simply crank the awning all the way out until the roller tube is exposed and continue cranking in the same direction. The fabric should then be rolling onto the bottom of the roller tube.

When the awning is extended to the desired position, push up on the crank handle and turn counter clockwise on quarter turn, which will release the crank handle from the housing. The crank handle can then be stored in a convenient place.

### 4-6.4.3 Motorized Operation (without wind sensor)

The motorized operation is simplicity in itself. The 110-volt motor is housed in the roller tube where it is protected from the elements.

To extend the awning all the way, move the switch to the down position.

After depressing the switch, the awning will then extend to its full projection. To retract the awning, press the switch in the up position. There is no need to hold the switch once it has been activated. To stop the awning at any point in its projection or retraction, move the switch to the middle position. The switch should be left in the center position at all times when the awning is stationary.

The motor used in the Girard G-2000 will use approximately 300 watts and will draw approximately 3 amps of power.

#### **WARNING!!**

**The motor in the Girard G-2000 is not designed for continuous use. In the event that the motor is used to excess, it will automatically shut off and be inoperative until the internal breaker cools down and resets. Run time is 4-5 minutes per hour. Reset time is 30 minutes to 1 hour depending on outside temperature.**

### 4-6.4.4 Wind Sensor Option:

#### **Wind Sensor V with Remote Control Summary**

If your Girard G-2000 awning is fitted with a wind sensor, your awning is designed to retract automatically in the event of high winds. The Wind Sensor will operate as long as it has a 110 volt power supply and the wind has unrestricted access to the wind sensor cups on the roof of your coach.

To operate the awning, simply push the button, momentarily, to extend the awning. The awning will continue to open until it reaches its full extension. It will then stop automatically. Pressing the button after the awning is fully extended will retract the awning automatically. Once the awning is fully closed, it will stop automatically, and the motor will turn off. The awning can be stopped at any point, and in either direction, by pushing the button while the awning is in process of either extending or retracting.

The wind sensor is dominant and will override any manual commands in the event of excessive winds. When the wind sensor is activated, the awning will close completely. The awning will NOT re-open automatically. It must be re-opened by once again pressing the button on the wall mount switch. It is recommended, however, to use the warnings of the wind sensor and leave the awning IN until the winds subside.



## Wind Sensor V Control

### Description

The Wind Sensor V is a single motor control designed for use on the Girard G-2000 Automatic Awning. The unit features the wind sensor control box, the wind sensor anemometer, and an attractive indoor, push-button wall mount switch. The Wind Sensor V Remote includes the additional, hand-held remote control, which is electronically integrated with the control box.

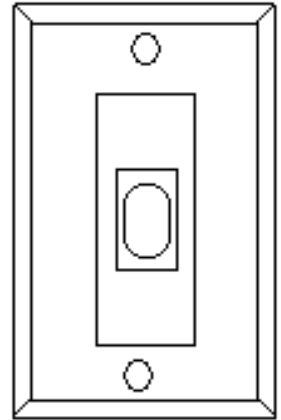

### Operation

1. Always be sure that sufficient 110 Volt power is supplied to the awning system for correct functioning of all component parts (controller, anemometer, awning motor, etc.) i.e., be sure that either the inverter is on, the generator is functioning, or the vehicle is connected to shore power.
2. Turn the vehicle power ON and/or turn the circuit breakers to ON.
3. Push the button on the Wind Sensor V control switch to EXTEND the awning. The button can be released and the awning will continue to open until it reaches full extension. It will then stop automatically.
4. Push the button on the Wind Sensor V control switch to RETRACT the awning. The button can be released and the awning will continue to retract until it is fully closed. The awning motor will then turn off automatically.
5. Push the button during either the extend or retract mode to STOP the awning at any desired position. The button can also be used to change direction of the awning by pushing it twice.

**NOTE:** The motor supplied with your Girard G-2000 Awning is a high torque/low RPM motor, and has been carefully selected for its reliability and application compatibility. It is designed for intermittent use with a rating of 4 minutes/hour. If the motor's run-time exceeds this time period, a built-in circuit breaker will disable the motor from operation. This condition indicates normal operation of your awning system, and generally only occurs during excessive adjustment periods. If this condition should occur, please allow sufficient time (up to one hour, depending on the outside temperatures) for the motor to reset and use the manual override feature.

## Wind Sensor Function

The Wind Sensor V Controller, and the Wind Sensor V Anemometer work together to continuously monitor the wind speeds, at any given minute, around your awning. If the actual wind speed becomes GREATER than the wind speed setting of your controller, a two (2) second delay occurs, and a signal is sent to the awning motor to retract the awning. THE AWNING WILL REMAIN IN THE RETRACTED POSITION UNTIL SUCH A TIME THAT IT IS ONCE AGAIN EXTENDED BY PRESSING THE BUTTON OF THE SWITCH PANEL.

## Adjusting the Wind Speed Setting

The Wind Sensor V has been factory pre-set to a maximum wind speed of 22 MPH. Under no circumstances should this level be set at higher speeds. It is recommended, however, that you become familiar with the location of your Wind Sensor Control Box. It is usually located inside of an upper cabinet. In the event that you wish to reduce the pre-set wind speed, locate your control box and remove the four (4) Phillips screws that secure the cover. Remove the cover and notice the small dial located near the center of the box. This dial should be pointed at 22. The minimum setting will be approximately 12 MPH.



### 4-6.4.5 Remote Control Programming

Normally, your remote control will come pre-programmed. However, if it is not, follow this procedure:

1. On the Control Box
  - To put the receiver in its programming mode, press the PROGRAM button and hold, until the LED lights up and then release. The Programming Button is located on the PCB Board inside the control box.
  - The receiver is now ready to memorize any transmitter/channel for a period of one (1) minute.
2. On the Transmitter
  - Press the Programming Button on the back of the transmitter. After one (1) minute, or once the receiver is programmed, the LED goes off. The transmitter is now programmed.
  - To verify the program, press the DOWN button to make sure that the awning is extending. If it does not, repeat the instructions from number one (1) above.

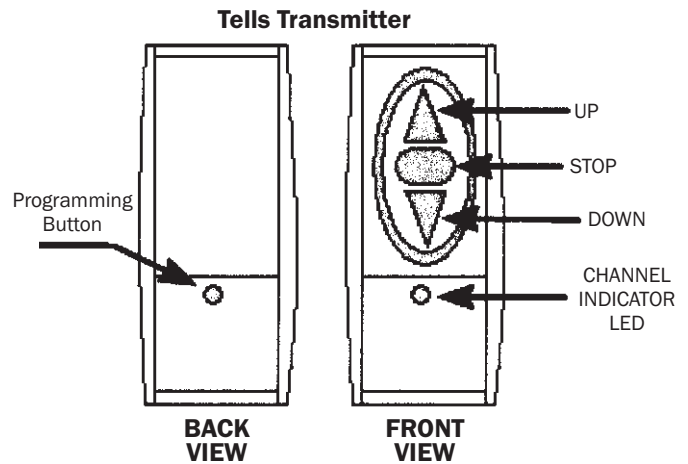

### 4-6.4.6 Remote Control Operation

#### Single channel transmitter:

- Press the UP, DOWN, or STOP button.
  - The programmed RTS receivers are activated.

#### Four channels transmitter:

- Select the channel of the motor module you wish to control.
  - The corresponding LED is blinking during 3 seconds (the channel is still memorized for 30s and then the transmitter returns to channel 1).
- Press the UP, DOWN or STOP button.
  - The programmed RTS receivers are activated.

#### Battery Life

The transmitters are filled with a 3V battery (type 2430) which provides about three years operation assuming 4 operations per day. When the battery becomes discharged, the control LED no longer lights up when a command is sent, and the command is not carried out. The module has an integrated backup control under the programming button. It operates by successive presses: raising, stop, lowering, stop.

#### How to Change the Battery:

- Remove the back cover of the transmitter with a screwdriver.
- Slide the battery out of its housing by pushing it with a screwdriver.
- Insert the new battery

### 4-6.4.7 Setting Motor Limits

IF THE AWNING DOES NOT CLOSE COMPLETELY, and there is no apparent binding of any awning components, then the fabric has most likely stretched or shifted slightly over time. This can be easily corrected by adjusting the motor limits. This will allow the awning roller tube to run a split second longer to draw the awning fabric in tighter.

**The Adjustment:**

- The MO (manual override) motor has manual limit switches for both the OUT (extend) and the IN (retract).
- The limit switches are adjusted by inserting the black plastic key (supplied) or a 5/32" / 4mm Allen wrench into the appropriate hole on the underside of the motor.
- The motor is usually located at the front of the awning inside the roller tube. The limit switches can be accessed by opening the awning a few feet, and are located above, at the end of the roller tube in the exposed end of the motor. These switches will appear as (2) hex shaped holes. You will also see a double arrow with a (+) and (-) sign next to each switch.
- The IN limit is the switch located closest to the vehicle side. The Girard G-2000 provides an exclusive current limiting device (MS-1) which detects the current increase as the awning box closes, and then shuts off power to the motor. This device eliminates the need or frequency for future in-bound limit switch adjustments. If this adjustment is still required however, and the awning box does not close completely, then this switch should be adjusted. To make the awning close MORE, first turn your main awning wall switch or wind sensor switch to the IN (retract) position. Place the plastic adjustment tool or Allen wrench into the switch and turn toward the (+) direction. This action will create a tighter fit as the awning box closes. Listen carefully to the motor to assure that the current limiting device has shut power off to the motor.
- The OUT limit is the switch located in the outer most location. This switch is factory pre-set so that the motor stops turning at the precise moment that the arms reach full extension. If further adjustment is required however, and to make the awning extend more and to release more fabric, first, place the main awning wall switch or wind sensor switch to the OUT (extend) position and extend the awning until the motor stops. Place the plastic adjustment tool or Allen wrench into the limit switch and turn toward the (+) arrow. The awning will "follow" as you turn. Turn switch until awning reaches full extension and the arms "click" into their locked position. To make the awning extend LESS, turn switch toward the (-) arrow, bring the awning in a few inches, then re-extend to see the new stop location.
  - To adjust IN Limits: Use the INNER most switch (+) closes more (-) closes less
  - To adjust OUT Limits: Use the OUTER most switch. (+) extends more (-) extends less.



**NOTE: If motor is mounted on LEFT end of the awning, the functions of the limit switches will be reversed.**

**4-8.4.8 Lead Rail Adjustments****Lateral Shifting of Lead Rail***Tools Required:*

- 5mm (3/16") Allen Wrench
- Phillips Screwdriver
- Rubber Mallet
- 1/8" Drill Bit and Drill Motor

The Lead Rail has shifted toward the front or toward the rear of the awning casing, preventing the awning from closing properly.

1. Open the awning about 2 feet.
2. Locate the connection bracket at the forward most portion of the arm at the Lead Rail. (Item #43 of Exploded view). Using an Allen Wrench, loosen the center set screw on this bracket, by  $\frac{3}{4}$  turn, which un-tightens this bracket from the Lead Rail. Repeat for all arms. Do NOT loosen the offset leveling screw found on the upper corner of the bracket assembly.
3. With a Phillips Head Screwdriver, remove the (2) fabric set screws (Item #50 of Exploded View) which secure the fabric to the Lead Rail.
4. Close the awning to about 4 inches and, using a rubber mallet, tap on the end of the Lead Rail, allowing it to shift relative to the fabric and arm attachments.

5. Close the awning to check for proper alignment.
6. Re-open the awning to about 2 feet and re-tighten set screws at each arm connection. Finish by replacing both fabric set screws.

**NOTE:** These screws should be located approx.  $\frac{3}{4}$ " from the edge of the fabric. If the adjustment process places either of these 2 screws further than this point, drill new holes ( $\frac{1}{8}$ " dia), and re-install fabric screws.

7. Close the awning completely to check for final fit.

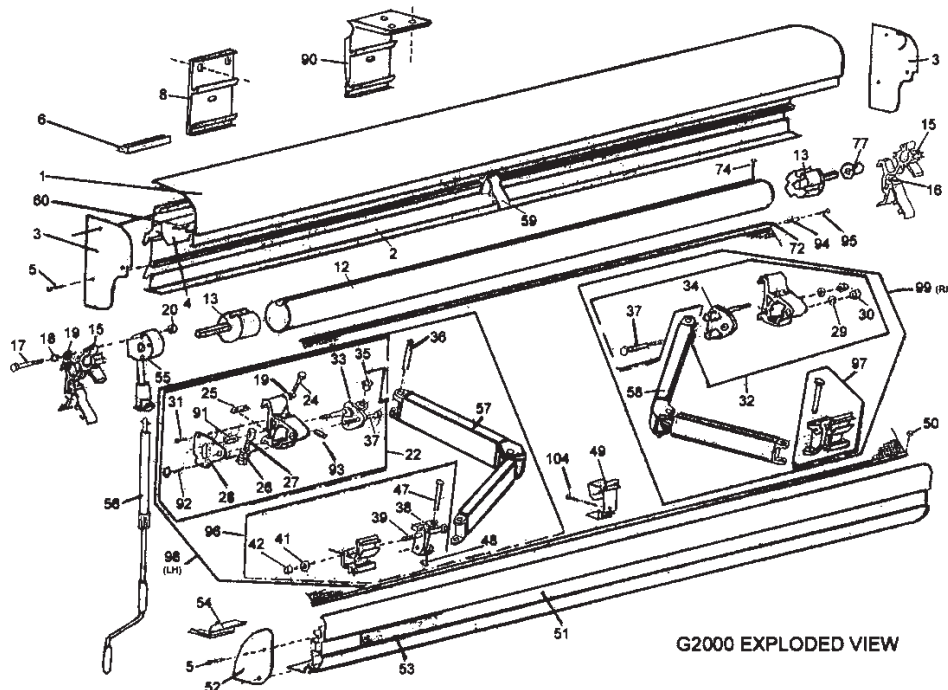

### “IN” Adjustment of Lead Rail

#### Tools Required

- 5mm (3/16”) Allen Wrench
- Rubber Mallet

This adjustment may be required if the Lead Rail remains out from the awning casing at one end. The Limit Switches may need to be adjusted. Please see that section entitled ADJUSTING MOTOR LIMIT SWITCHES. Otherwise, arms may need to be adjusted as follows:

1. Open the awning about 16 inches.
2. At the selected arm, locate the connection bracket at the forward most portion of the arm at the Lead Rail (Item #43 of Exploded View). Using a 5mm (3/16) Allen Wrench, loosen the center set screw on this bracket, by  $\frac{3}{4}$  turn, which un-tightens this bracket from the Lead Rail. This bracket should now be free to slide. Do NOT loosen the offset leveling screw found on the upper corner of this bracket assembly.
3. Close awning completely and the arms will relocate themselves to the proper location. Re-open the awning just far enough to re-tighten the arm screws.

### Pivotal Adjustment of Lead Rail

#### Tools Required:

- 5mm (3/16”) Allen Wrench
- 17mm (11/16) Open End Wrench

This adjustment, not being available on earlier models, affects the pivotal angle of the Lead Rail and is seldom required, as, this angle is factory preset. However, if adjustments are required, the procedures are:

1. Open the awning about 16 inches.
2. Locate the connection bracket at the forward most portion of the left/rear arm, i.e., the arm furthest from the motor. (*Item #43 of Exploded View*)
3. The “pivoting” style connection bracket can be identified by having one set screw in the center of the bracket, in addition to a second set screw at the upper portion of the pivoting section of the bracket assembly. The non-pivoting style bracket has two set screws, in-line, in the center of the bracket.
4. If the pivoting style bracket is present, grasp the Lead Rail with one hand and manually pivot, up and down, the Lead Rail on this bracket. It should pivot freely. If it does not pivot freely, loosen slightly, the large lock nut on the end of the horizontal bolt that fastens these two pivoting brackets together. This should free the two brackets and allow a pivot between them. Repeat for each arm, if necessary.
5. Using the awning switch and motor, close the awning to about 3”. Check the angle of the Lead Rail in relation to the awning casing. The Lead Rail should approach the awning casing with the TOP portion of the Lead Rail striking the casing FIRST. From the TOP of the Lead Rail, a 10 degree angle should occur as it angles away from the awning casing. If this angle is not present, again open the awning to about 18”. Locate the UPPER set screw in the pivoting portion of the connection bracket. Using a 5mm (3/16”) allen wrench, turn this set screw (counterclockwise) to achieve the desired 10 degree angle. Repeat this procedure for each of the arm connections, assuring that the proper angle and “free pivot” condition is maintained.

### Height Adjustment of Arms (*see Exploded View - Item No. 37*)

Tools Required:

- 19mm (3/4”) Open End Wrench
- 10mm (3/8”) Open End Wrench

This adjustment may be required if, as the awning Lead Rail closes into the awning casing, the “elbow” of one of the arms is hanging downward, hitting the bottom of the casing. This adjustment is usually required after an arm replacement.

1. Open the awning about 18 inches.
2. At the selected turn, loosen the (2) locknuts located at the side of the upper arm connection using a 19mm (3/4”) open end wrench.
3. See *Item No. 92 in Exploded View*. Locate the smaller adjustment bolt located directly under the rear locknut that was just loosened. Place a 10mm (3/8”) open end wrench around this bolt head, and rotate the wrench in a TIGHTEN direction to RAISE the arm. Slight rotation is all that is necessary. Likewise, LOOSENING the bolt will LOWER the arm. As this adjustment is being performed, keep in mind that after re-tightening the Locknuts, the arm will raise slightly further.
4. Tighten the (2) locknuts located on the side of the arm connection.
5. Close the awning completely, and check for proper fit.

**PITCH ANGLE:** The awning comes factory pre-set with a pitch angle of approximately 20°. This represents the minimum angle recommended for proper rain run-off. If it is desired to increase this angle, loosen the two (2) lock nuts located on the outside upper joint of each arm using a 3/4” or 19 mm wrench (*see fig. 2a*). Adjust the arms downward by rotating the bolt head at the bottom of the arm connection in a counter clockwise direction (looking from the bottom up) (*see fig. 2b*). Likewise, rotating the bolt in a clockwise direction will raise the arm. After all arms are adjusted to an equal height, re-tighten lock nuts on the side of each arm (*see fig. 2c*).

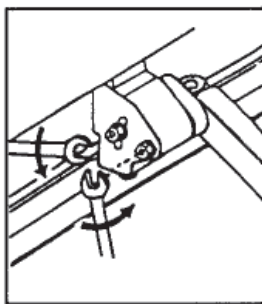

Figure 2a

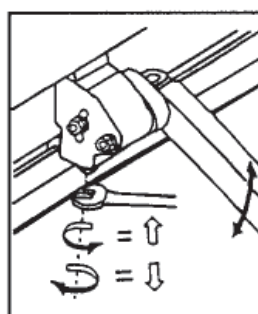

Figure 2b

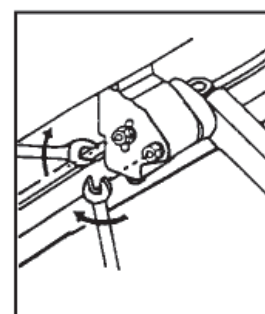

Figure 2c

### 4-6.4.9 Care and Cleaning of the Acrylic Fabric:

Acrylic fabric should be cleaned regularly before substances such as dirt, leaves, etc. are allowed to accumulate on, and become embedded in the fabric. The fabric can be cleaned without being removed from the awning casing. Simply brush off any loose dirt, leaves, etc. Hose down and clean with cloth and a mild solution of natural soap in lukewarm water. Rinse thoroughly to remove soap. **DO NOT USE DETERGENTS.** Allow to air dry, preferably on a warm sunny day. Should you have to retract the awning when the fabric is wet, it should be extended at the first opportunity to finish air drying.

A new acrylic fabric cleaner is now available at Girard Systems. This unique product has been specially formulated to clean all acrylic awning fabrics. Call (800) 382-8442 for ordering information.

**Warranty:** Girard Systems offers a five year warranty for its awnings to be free from defects in material and workmanship under normal and proper use. For the full warranty look in the black box material that was supplied with your coach or go to <http://www.girardrv.com>

Please remember that the Girard G-2000 Awning is a high-technology, retractable structure, and is built with a high level of pride and workmanship. All steps have been taken to provide a product of the highest quality, performance, and weather protection, including wind and rain protection. As any other investment, it should be respected and protected. It is the owners responsibility to use good judgment and assert caution when using this product in heavy weather conditions. During heavy or unpredictable rain conditions, or during strong winds, the awning should be retracted.

### 4-6.4.10 Troubleshooting

**NOTE:** These troubleshooting tips are offered to you for informational purposes and it is recommended that the following adjustments be made by an authorized service center. This guide will, however, allow you to become more familiar with your awning and will provide you with adequate knowledge in the event of an emergency.

PROBLEM	SOLUTION
Lead Rail is binding on side of awning casing, i.e. is offset from awning casing.	Open awning about three (3) feet. Loosen both set screws on each arm at their point of connection to the lead rail. Remove both fabric set screws located at each end of the lead rail. The lead rail is now ready to be shifted. Close the awning to about four (4) inches and, using a rubber mallet, tap on the end of the lead rail to move the rail over. Check for proper alignment, retighten the set screws, and replace the fabric set screws. For more information see " <a href="#">LATERAL SHIFTING OF LEAD RAIL.</a> "
One part of the box (opposite end from motor) does not close tightly. Motor end closes correctly.	See " <a href="#">IN AND OUT ADJUSTMENT OF LEAD RAIL.</a> "
After above adjustment, one end of box (opposite end from motor) STILL does not close tightly. Motor end closes correctly.	On later model awnings, a "pivotal" adjustment of the lead rail is available. This means that the lead rail is allowed to PIVOT on its connection bracket to the awning ARMS. First, check that this option is present. If so, check that the lead rail is free to pivot on its pivot bolt. If not, loosen the lock nut on the pivot bolt by 1/2 turn. Additionally, check that the pivot angle is correct.
The motor will not operate.	Check that the GFI circuit breaker in the vehicle is turned on. Also, if the vehicle is equipped with an awning main power switch, located inside the cabinets, check that it is turned on. The 110V motor in the Girard awning is for intermittent use only (4 Min Per Hour) and is designed to "temporarily cut out" if it is used to the point of overheating. In this event, the motor must be allowed to cool, to provide time for its built-in circuit breaker to reset. Please allow up to one hour, depending on outside air temperature, for this cool down period. The manual crank can be used during this period.
The motor will not operate, or the motor will operate long enough for the awning to extend 10 to 12 inches and then stops.	The motor is not receiving enough amps, i.e., the inverter output is low. Check that a minimum of 10 amps is running. If not, turn on the generator or go to shore power.
The fabric is loose when the awning is fully extended, i.e., the roller keeps turning after the awning arms have locked open.	The motor "OUT" limits need to be re-set (see <a href="#">Setting Motor Limits</a> section) to ensure that the motor stops when the arms are fully extended and locked.
The box does not close completely, i.e., the motor stops before the lead rail has retracted completely (on either end) into the awning casing. There is no apparent binding of the awning components.	Your awning is equipped with a MO (manual override) motor which has manual limit settings. The "IN" limit may need to be re-set to allow the box to close tighter. See " <a href="#">Setting Motor Limits</a> " section.
As the awning is closing, the "elbow" of one or more of the arms is hanging downward, preventing the case from closing.	Open the awning about 18 inches. At the selected arm, loosen the two (2) large lock nuts located at the side of the upper arm connection. Locate the smaller adjustment bolt head directly under the REAR lock nut and rotate SLIGHTLY UPWARD to raise the arm. Retighten lock nuts. NOTE: After re-tightening lock nuts the arm will raise slightly further. See <a href="#">Height Adjustment of Arms.</a>

## 4-6.4.11 Adjustments

### Adjusting Motor Limit Switches

#### Tools Required

Black plastic key provided with awning or 4mm Allen Wrench

#### PROCEDURE

The limit switches are adjusted at the factory, prior to shipment, such that the awning motor stops at the EXACT moment the awning box closes. Likewise, the awning motor is set to stop at the EXACT moment that, while opening, the elbowing arms “click” into an outward locked position. Occasionally, after shipment and installation, the motor rotational limits “creep” out of adjustment. It is always wise to check the motor limits after installation to assure that the awning is opening and closing correctly. Additionally, over a period of time the awning fabric can stretch, causing the need for simple motor limit adjustments.

**VERY IMPORTANT:** Extreme care must be taken when setting the “IN” limits of the motor, such that the motor turns off EXACTLY the same time the box closes. Otherwise, the motor will continue to run, as it has not reached its limit. This condition, if not corrected, will substantially reduce motor life. Turn the awning switch OFF.

If adjustments are required, please follow these instructions:

1. The BMO (Manual Override) motor has limit settings for both the OUT direction (projection) and the IN direction (retraction).
2. Limit switches are adjusted using the black plastic key (provided) or a 4mm Allen Wrench.
3. Open the awning a few feet and locate the awning motor, installed standard at the right end of the awning (front end). It is a cylindrical motor mounted inside the awning roller tube. The limit switches are mounted inside the black casing at the exposed end of the motor. Notice at the limit switches a BLACK arrow and a RED arrow, both with a (+) plus and (-) sign. The actual limit switch is the recessed hole next to the corresponding arrow.
4. The IN limit is the BLACK arrow. To make the awning close MORE, first turn the main awning wall switch or Wind Sensor switch to the IN (retract) position. At the motor, insert the tool and turn the switch next to the BLACK arrow in the direction of the (+) sign.  $\frac{1}{4}$  turn represents approximately 1” of the awning movement. This action will create a tighter fit as the awning box closes. To make it close LESS, turn in the direction of the (-) sign. [See Fig. 1.](#)

 **NOTE: If the awning motor is installed on the LEFT end of the awning, the actions of the red and black arrows will be reversed.)**

**FOR MOTORS WITH BLACK PLASTIC CASINGS ONLY**

To adjust IN Limits: Use switch next to BLACK arrow (+) closes more (-) closes less  
 To adjust OUT Limits: Use switch next to RED arrow (+) extends more (-) extends less

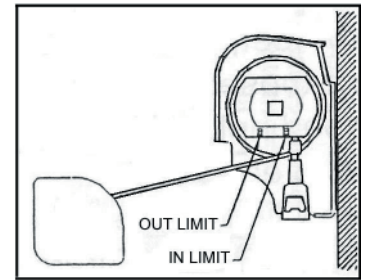

Fig. 1 Motors with Black Plastic Casings

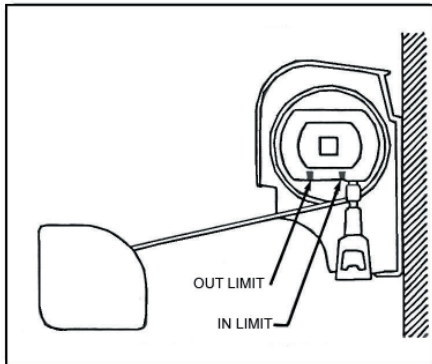

Fig. 2 Motors with Silver Aluminum Casings

**FOR MOTORS WITH SILVER ALUMINUM CASINGS:**

To adjust IN Limits: Turn the switch located toward the REAR of the motor. (+) closes more (-) closes less.

To adjust OUT Limits: Turn the switch located toward the FRONT of the motor. (+) extends more (-) extends less.

The OUT limit is the RED arrow. To make the awning extend MORE and release more fabric, first turn the main awning wall switch or the Wind Sensor switch to the OUT (extend) position and extend the awning to its maximum position. Proceed by turning the limit switch next to the RED arrow in the direction of the (+) sign. To make the awning extend LESS, turn the switch in the (-) direction. See Fig. 1.

**NOTE:** If the awning motor is installed on the LEFT end of the awning, the actions of the red and black arrows will be reversed.

**NOTE:** Never set outward limits such that slack fabric occurs after full extension of the arms. Adjust the limit switches such that the motor stops at the EXACT time that the elbowing arms “click” into a locked position.

**4-6.4.12 Adjusting the Awning Pitch Angle**

Tools Required:

19mm (3/4”) Open End Wrench

The awning comes factory pre-set with a pitch angle of approximately 20 degrees. If it is desired to increase the angle, loosen the (2) lock nuts located on the outside upper joint of each arm using a 3/4” or 19mm wrench. See Fig. 2a. Adjust the arms DOWNWARD by rotating the bolt head at the bottom of the arm connection in a CLOCKWISE direction (looking from the bottom up). See Fig. 2b. Likewise, rotating the bolt in a COUNTER CLOCKWISE direction will RAISE the arm. After all arms are adjusted to the desired height, re-tighten lock nuts on the side of each arm. See Fig. 2c

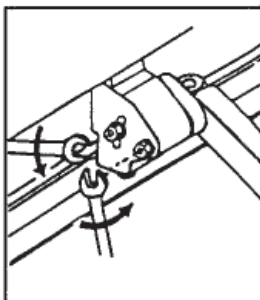

Figure 2a

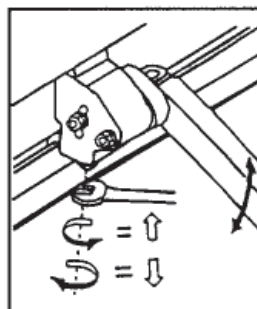

Figure 2b

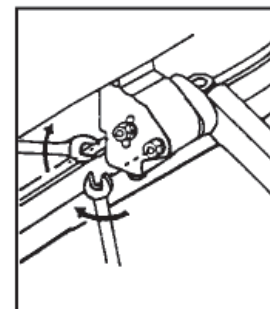

Figure 2c



### 4-6.4.13 Lead Rail Adjustments

#### Lateral Shifting of Lead Rail

Tools Required:

- 5mm (3/16") Allen Wrench
- Phillips Screwdriver
- Rubber Mallet
- 1/8" Drill Bit and Drill Motor

The Lead Rail has shifted toward the front or toward the rear of the awning casing, preventing the awning from closing properly.

1. Open the awning about 2 feet.
2. Locate the connection bracket at the forward most portion of the arm at the Lead Rail. (*Item #43 of Exploded View*). Using an Allen Wrench, loosen the center set screw on this bracket, by  $\frac{3}{4}$  turn, which un-tightens this bracket from the Lead Rail. Repeat for all arms. Do NOT loosen the offset leveling screw found on the upper corner of the bracket assembly.
3. With a Phillips Head Screwdriver, remove the (2) fabric set screws (*Item #50 of Exploded View*) which secure the fabric to the Lead Rail.
4. Close the awning to about 4 inches and, using a rubber mallet, tap on the end of the Lead Rail, allowing it to shift relative to the fabric and arm attachments.
5. Close the awning to check for proper alignment.
6. Re-open the awning to about 2 feet, and re-tighten set screws at each arm connection. Finish by replacing both fabric set screws.

 **NOTE: These screws should be located approx.  $\frac{3}{4}$ " from the edge of the fabric. If the adjustment process places either of these 2 screws further than this point, drill new holes (1/8" dia) and re-install fabric screws.**

7. Close awning completely to check for final fit.

### 4-6.4.14 "IN" Adjustment of Lead Rail

Tools Required:

- 5mm (3/16") Allen Wrench
- Rubber Mallet

This adjustment may be required if the Lead Rail remains out from the awning casing at one end. The Limit Switches may need to be adjusted. Please see that section entitled [ADJUSTING MOTOR LIMIT SWITCHES](#). Otherwise, arms may need to be adjusted as follows:

1. Open the awning about 16 inches.
2. At the selected arm, locate the connection bracket at the forward most portion of the arm at the Lead Rail (*Item #43 of Exploded View*). Using a 5mm (3/16) Allen Wrench, loosen the center set screw on this bracket, by  $\frac{3}{4}$  turn, which un-tightens this bracket from the Lead Rail. This bracket should now be free to slide. Do NOT loosen the offset leveling screw found on the upper corner of this bracket assembly.
3. Close awning completely and the arms will relocate themselves to the proper location. Re-open the awning just far enough to re-tighten the arm screws.

### 4-6.4.15 Pivotal Adjustment of Lead Rail

Tools Required:

- 5mm (3/16") Allen Wrench
- 17mm (11/16) Open End Wrench

This adjustment, not being available on earlier models, affects the pivotal angle of the Lead Rail and is seldom required, as, this angle is factory preset. However, if adjustments are required, the procedures are:

1. Open the awning about 16 inches.
2. Locate the connection bracket at the forward most portion of the left/rear arm, i.e., the arm furthest from the motor. (*Item #43 of Exploded View*).
3. The "pivoting" style connection bracket can be identified by having one set screw in the center of the bracket, in addition to a second set screw at the upper portion of the pivoting section of the bracket assembly. The non-pivoting style bracket has two set screws, in-line, in the center of the bracket.
4. If the pivoting style bracket is present, grasp the Lead Rail with one hand and manually pivot, up and down, the Lead Rail on this bracket. It should pivot freely. If it does not pivot freely, loosen slightly, the large lock nut on the end of the horizontal bolt that fastens these two pivoting brackets together. This should free the two brackets and allow a pivot between them. Repeat for each arm, if necessary.
5. Using the awning switch and motor, close the awning to about 3". Check the angle of the Lead Rail in relation to the awning casing. The Lead Rail should approach the awning casing with the TOP portion of the Lead Rail striking the casing FIRST. From the TOP of the Lead Rail, a 10 degree angle should occur as it angles away from the awning casing. If this angle is not present, again open the awning to about 18". Locate the UPPER set screw in the pivoting portion of the connection bracket. Using a 5mm (3/16") Allen Wrench, turn this set screw (counterclockwise) to achieve the desired 10 degree angle. Repeat this procedure for each of the arm connections, assuring that the proper angle and "free pivot" condition is maintained.

### 4-6.4.16 Height Adjustment of Arms

(*see Exploded View - Item No. 37*)

Tools Required:

- 19mm (3/4") Open End Wrench
- 10mm (3/8") Open End Wrench

This adjustment may be required if, as the awning Lead Rail closes into the awning casing, the "elbow" of one of the arms is hanging downward, hitting the bottom of the casing. This adjustment is usually required after an Arm replacement.

1. Open the awning about 18 inches.
2. At the selected arm, loosen the (2) Locknuts located at the side of the upper arm connection using a 19mm (3/4") Open End Wrench.
3. *See Exploded View Item #92*. Locate the smaller adjustment bolt located directly under the rear Locknut that was just loosened. Place a 10mm (3/8") Open End Wrench around this bolt head, and rotate the wrench in a TIGHTEN direction to RAISE the arm. Slight rotation is all that is necessary. Likewise, LOOSENING the bolt will LOWER the arm. As this adjustment is being performed, keep in mind that after re-tightening the Locknuts, the arm will raise slightly further.
4. Tighten the (2) locknuts located on the side of the arm connection.
5. Close the awning completely, and check for proper fit.

## 4-7 Slide-Out Operation

### 4-7.1 Introduction

The 450 LXi Slide-out Control System controls the extend/retract operation of the multiple slide-out rooms on the 450 LXi motor home platforms - 450LXi & 400LXi models. The control system is capable of operating one to three slide-out rooms with one or two electric motor actuators.

The 450 LXi structure can accommodate three slide-out rooms: two living room - left & right; one bedroom - left. The Slide-out Control System is capable of controlling three slide-out rooms, each with two electric motor actuators. The present configuration is setup for three slide-out rooms: two living room - left & right, each with two electric motor actuators; one bedroom - left, with one electric motor actuator.

Each slide-out room has two air cylinder locks which are sequenced by the Slide-out Control System. These air locks are retracted when the slide-out rooms are in any position other than fully extended or fully retracted; i.e. the air locks are only extended when the slide-out rooms are fully extended or fully retracted.



450 LXi shown here with two slide-out rooms.

#### CAUTION!!

If the locks are manually extended with the slide-out room in an intermediate position, the locks will cause severe damage to the slide-out room sides.

### 4-7.2 Overview

The Slide-out Control System applies power to the electric motor actuator(s) to move the slide-out room In or Out when the respective Room Motion switch is pressed. The Slide-out PLC Controller examines the state of five parameters: Ignition switch in the Accessory position, parking brake, system air pressure, lock state, & IN/OUT limit switches before processing the IN/OUT command from the respective Room Motion switches. When all parameters are in the correct states, the Slide-out PLC Controller sequences the air locks and executes a IN/OUT command.

The Power Supply Assembly operates from panel #2, circuit breaker 4B of the 120VAC load center. This converts 120VAC to 27VDC which provides power to the Slide-out PLC Controller, the Dual Motor Synchronizer, and the slide-out room motor actuators.

**NOTE:** Circuit Breaker 4B must be ON to operate slide-out room. If the locks are manually extended with the slide-out room in an intermediate position, the locks will cause severe damage to the slide-out room sides.

#### 4-7.2.1 Room Motion Switch Assembly

The Room Motion Switch Assembly provides the slide-out room IN & OUT control switches along with eight status LED indicators. The IN switch moves the room inward as long as the switch is depressed. The IN switch should remain pressed until the LOCKED LED lights indicating that the Room In sequence has completed. The Room In motion can be stopped at an intermediate state by releasing the IN switch. The room in motion can resume by pressing & holding the IN switch or the Room Out motion can proceed by pressing the OUT switch. The OUT switch moves the room outward as long as the switch is depressed. The OUT switch should remain pressed until the LOCKED LED lights indicating the Room Out sequence has completed.

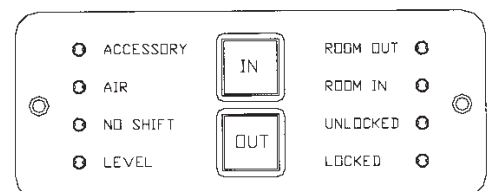

Figure 1 - Room Motion Switch Panel

**Table 1 - Room Motion Switch Status LEDs - Normal Operation**

LED	Type	Description
Accessory	Common	Air
Air	Common	Indicates the System AIR pressure is greater than 90 psi. The air pressure is required to operate the slide-out room locks.
No Shift	Common	Indicates the transmission cannot be shifted from its present state. The NO SHIFT state occurs whenever any slide-out room IN limit switch is not closed.
Level	Common	Indicates when the coach is LEVEL. This is not a necessary condition for slide-out operation and is only for status purposes.
Room Out	Specific	Indicates that the OUT limit switches are closed. <i>Note: the living room slide-out rooms have two OUT limit switches; the bedroom slide-out room has one OUT limit switch.</i>
Room In	Specific	Indicates that the IN limit switches are closed. <i>Note: the living room slide-out rooms have two IN limit switches; the bedroom slide-out room has one IN limit switch.</i>
Unlocked	Specific	Indicates the UNLOCKED limit switches are closed. Each slide-out room has two locks & two UNLOCKED limit switches.
Locked	Specific	Indicates the LOCKED limit switches are closed. Each slide-out room has two locks & two LOCKED limit switches.

## 4-7.3 Slide-Out Room Operation

### 4-7.3.1 Normal Mode

- Accessory State:** Ignition in Accessory position, Parking brake ON.
- Level State:** Level condition not required for slide-out operation. Level LED indicates Level state only.
- Locked State:** Both slide-out room locks are in the LOCKED state.
- Unlocked State:** Both slide-out room locks are in the UNLOCKED state.
- No Shift State:** Transmission inhibited from shifting gears. The Shift Inhibit relay closes when any Room IN limit switch is not closed which indicates the respective slide-out room is in the IN state. The NO SHIFT LED indicates the transmission cannot be shifted.

**Note:** The Shift Inhibit relay opens (disengages) when the 12V power to the Slide-out PLC Controller is not present which can occur when the 120VAC/27VDC power supply is unplugged or the 120VAC circuit breaker in respective load center is OFF, there is no utility power (shore or generator), or Inverter-1 is not ON.

- Air State:** System air pressure greater than 90 psi.
- In State:** Both slide-out room IN limit switches are closed.
- Out State:** Both slide-out room OUT limit switches are closed.

### 4-7.3.2 Service Mode

When the Service switch is in the "ON" position, the "Shift Inhibit" relay engages and prevents the coach transmission from shifting gears. The Service Mode overrides the "Accessory" and the "Air System" interlock conditions required for Normal Slide-out operation; i.e. the "Accessory LED" and "Air LED" on the Room Motion Switch Panel do not have to be lighted for Slide-out operation. The "No Shift LED" on the Room Motion Switch Panel is lighted.

## 4-7 Slide-Out Operation

### 4-7.1 Introduction

The 450 LXi Slide-out Control System controls the extend/retract operation of the multiple slide-out rooms on the 450 LXi motor home platforms - 450LXi & 400LXi models. The control system is capable of operating one to three slide-out rooms with one or two electric motor actuators.

The 450 LXi structure can accommodate three slide-out rooms: two living room - left & right; one bedroom - left. The Slide-out Control System is capable of controlling three slide-out rooms, each with two electric motor actuators. The present configuration is setup for three slide-out rooms: two living room - left & right, each with two electric motor actuators; one bedroom - left, with one electric motor actuator.

Each slide-out room has two air cylinder locks which are sequenced by the Slide-out Control System. These air locks are retracted when the slide-out rooms are in any position other than fully extended or fully retracted; i.e. the air locks are only extended when the slide-out rooms are fully extended or fully retracted.



450 LXi shown here with two slide-out rooms.

#### CAUTION!!

If the locks are manually extended with the slide-out room in an intermediate position, the locks will cause severe damage to the slide-out room sides.

### 4-7.2 Overview

The Slide-out Control System applies power to the electric motor actuator(s) to move the slide-out room In or Out when the respective Room Motion switch is pressed. The Slide-out PLC Controller examines the state of five parameters: Ignition switch in the Accessory position, parking brake, system air pressure, lock state, & IN/OUT limit switches before processing the IN/OUT command from the respective Room Motion switches. When all parameters are in the correct states, the Slide-out PLC Controller sequences the air locks and executes a IN/OUT command.

The Power Supply Assembly operates from panel #2, circuit breaker 4B of the 120VAC load center. This converts 120VAC to 27VDC which provides power to the Slide-out PLC Controller, the Dual Motor Synchronizer, and the slide-out room motor actuators.

**NOTE:** Circuit Breaker 4B must be ON to operate slide-out room. If the locks are manually extended with the slide-out room in an intermediate position, the locks will cause severe damage to the slide-out room sides.

#### 4-7.2.1 Room Motion Switch Assembly

The Room Motion Switch Assembly provides the slide-out room IN & OUT control switches along with eight status LED indicators. The IN switch moves the room inward as long as the switch is depressed. The IN switch should remain pressed until the LOCKED LED lights indicating that the Room In sequence has completed. The Room In motion can be stopped at an intermediate state by releasing the IN switch. The room in motion can resume by pressing & holding the IN switch or the Room Out motion can proceed by pressing the OUT switch. The OUT switch moves the room outward as long as the switch is depressed. The OUT switch should remain pressed until the LOCKED LED lights indicating the Room Out sequence has completed.

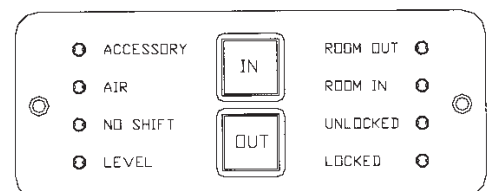

Figure 1 - Room Motion Switch Panel

**Table 1 - Room Motion Switch Status LEDs - Normal Operation**

LED	Type	Description
Accessory	Common	Air
Air	Common	Indicates the System AIR pressure is greater than 90 psi. The air pressure is required to operate the slide-out room locks.
No Shift	Common	Indicates the transmission cannot be shifted from its present state. The NO SHIFT state occurs whenever any slide-out room IN limit switch is not closed.
Level	Common	Indicates when the coach is LEVEL. This is not a necessary condition for slide-out operation and is only for status purposes.
Room Out	Specific	Indicates that the OUT limit switches are closed. <i>Note: the living room slide-out rooms have two OUT limit switches; the bedroom slide-out room has one OUT limit switch.</i>
Room In	Specific	Indicates that the IN limit switches are closed. <i>Note: the living room slide-out rooms have two IN limit switches; the bedroom slide-out room has one IN limit switch.</i>
Unlocked	Specific	Indicates the UNLOCKED limit switches are closed. Each slide-out room has two locks & two UNLOCKED limit switches.
Locked	Specific	Indicates the LOCKED limit switches are closed. Each slide-out room has two locks & two LOCKED limit switches.

## 4-7.3 Slide-Out Room Operation

### 4-7.3.1 Normal Mode

- Accessory State:** Ignition in Accessory position, Parking brake ON.
- Level State:** Level condition not required for slide-out operation. Level LED indicates Level state only.
- Locked State:** Both slide-out room locks are in the LOCKED state.
- Unlocked State:** Both slide-out room locks are in the UNLOCKED state.
- No Shift State:** Transmission inhibited from shifting gears. The Shift Inhibit relay closes when any Room IN limit switch is not closed which indicates the respective slide-out room is in the IN state. The NO SHIFT LED indicates the transmission cannot be shifted.

**Note:** The Shift Inhibit relay opens (disengages) when the 12V power to the Slide-out PLC Controller is not present which can occur when the 120VAC/27VDC power supply is unplugged or the 120VAC circuit breaker in respective load center is OFF, there is no utility power (shore or generator), or Inverter-1 is not ON.

- Air State:** System air pressure greater than 90 psi.
- In State:** Both slide-out room IN limit switches are closed.
- Out State:** Both slide-out room OUT limit switches are closed.

### 4-7.3.2 Service Mode

When the Service switch is in the “ON” position, the “Shift Inhibit” relay engages and prevents the coach transmission from shifting gears. The Service Mode overrides the “Accessory” and the “Air System” interlock conditions required for Normal Slide-out operation; i.e. the “Accessory LED” and “Air LED” on the Room Motion Switch Panel do not have to be lighted for Slide-out operation. The “No Shift LED” on the Room Motion Switch Panel is lighted.

### 4-7.3.3 Emergency Mode

When the Emergency switch is in the "ON" position, the "Shift Inhibit" relay disengages and allows the coach transmission to shift gears. The Emergency Mode overrides the "Accessory" and the "Air System" interlock conditions required for Normal Slide-out operation; i.e. the "Accessory LED" and "Air LED" on the Room Motion Switch Panel do not have to be lighted for Slide-out operation. The "No Shift LED" on the Room Motion Switch Panel is not lighted. This mode is used in an emergency situation and allows the coach to move when all interlock conditions are not satisfied. One such situation would be when slide-out rooms are not retracted.

**IMPORTANT NOTE!! The Slide-Room Controller is located in Bay 2 - left.**

## 4-7.4 Accessory Air System Moisture Purge Procedure

During humid weather or high air-use conditions, it is necessary to purge moisture (liquid) from the accessory air system frequently. This purging should be performed weekly or more often to ensure moisture-free air is supplied to the accessory components.

Please refer to the diagram below for location of drain valves. These valves are located in the front accessory compartment directly below the driver. Slowly open each valve to expel accumulated liquid and close tightly after clear air is observed.

**CAUTION!!** Point loose end of drain valve tube away from you - liquid is expelled at a high velocity!

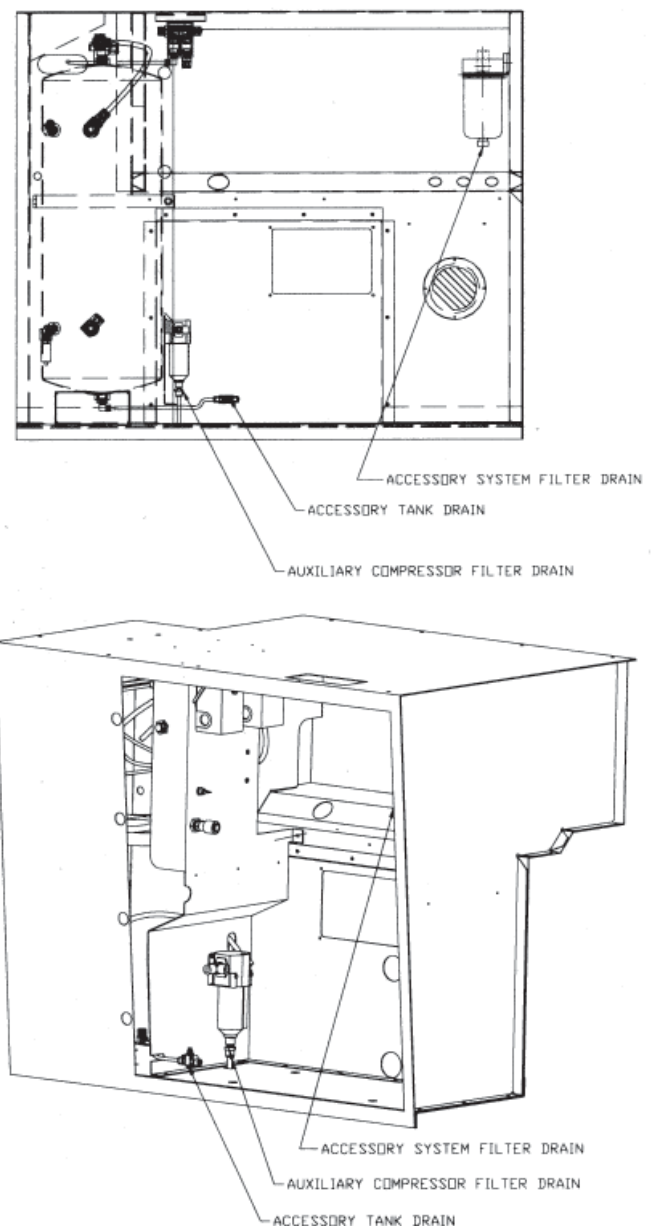

### 4-7.4.1 Purge Procedure Step Two

If more than 2 ounces of water still exits after purge procedure has been performed, and locks are still not working, the following procedure can be used to purge the remaining water and restore locks to proper working order.

1. Loosen cap on schrader valve and using a pen or screwdriver press center of valve to release excess water. Be sure to stand to one side or another or water will spray you.
2. Tighten cap finger tight.

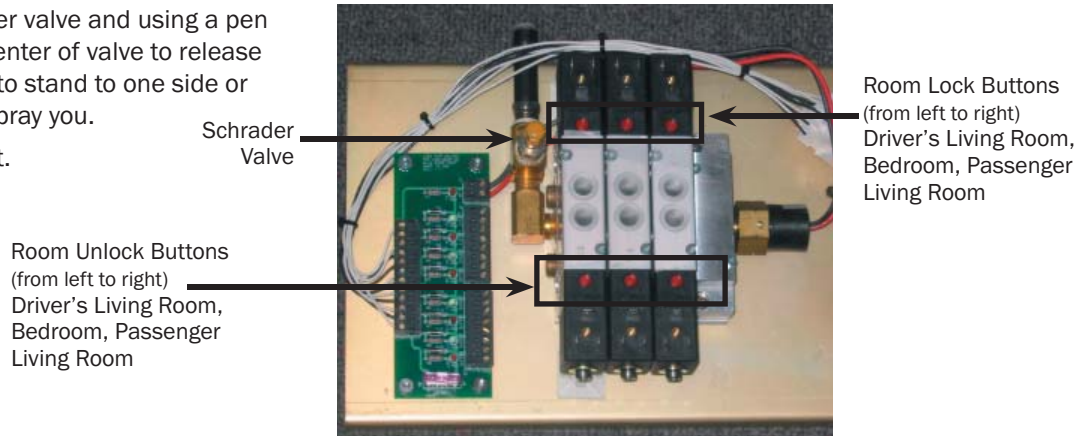

Slideout Controller (with cover off) located in Bay 2 of coach.

**WARNING!!** Perform steps 3 and 4 of this procedure only if room is fully extended or fully retracted (in or out). If unsure whether rooms are fully out you can measure from flat side of coach to the end of the room. Driver's Side Living Room extends 24", Bedroom extends 22" and Passenger Side Living Room extends 18". Failure to comply can severely damage the coach, voiding warranty.

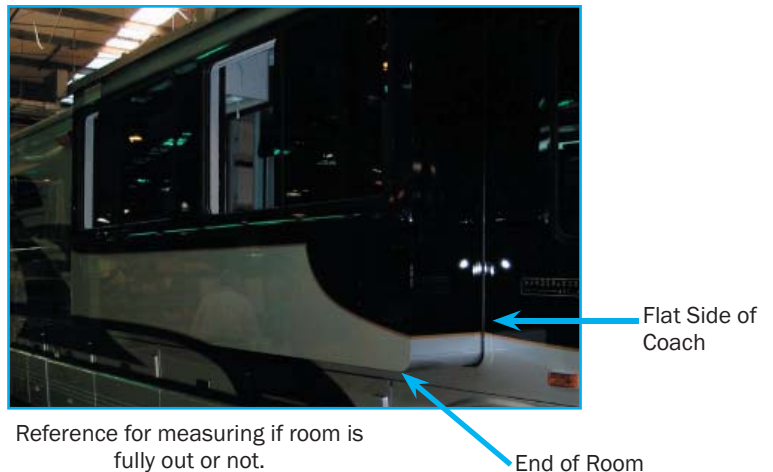

3. If room(s) are in locked position, press first red bottom on left of the Room Unlock Buttons on bottom of controller. Press second button (middle) and then the button on right.
4. If you know for absolute sure that the room(s) are completely in (flush with side of coach) or out (see figure above) then press top left red button of the Locking Buttons on controller, press middle button and then right button.

The excess water should all be fully purged from system and coach slideouts should operate properly.

See following page for diagram of controller if any questions.



**Air Lock Valve Assembly**

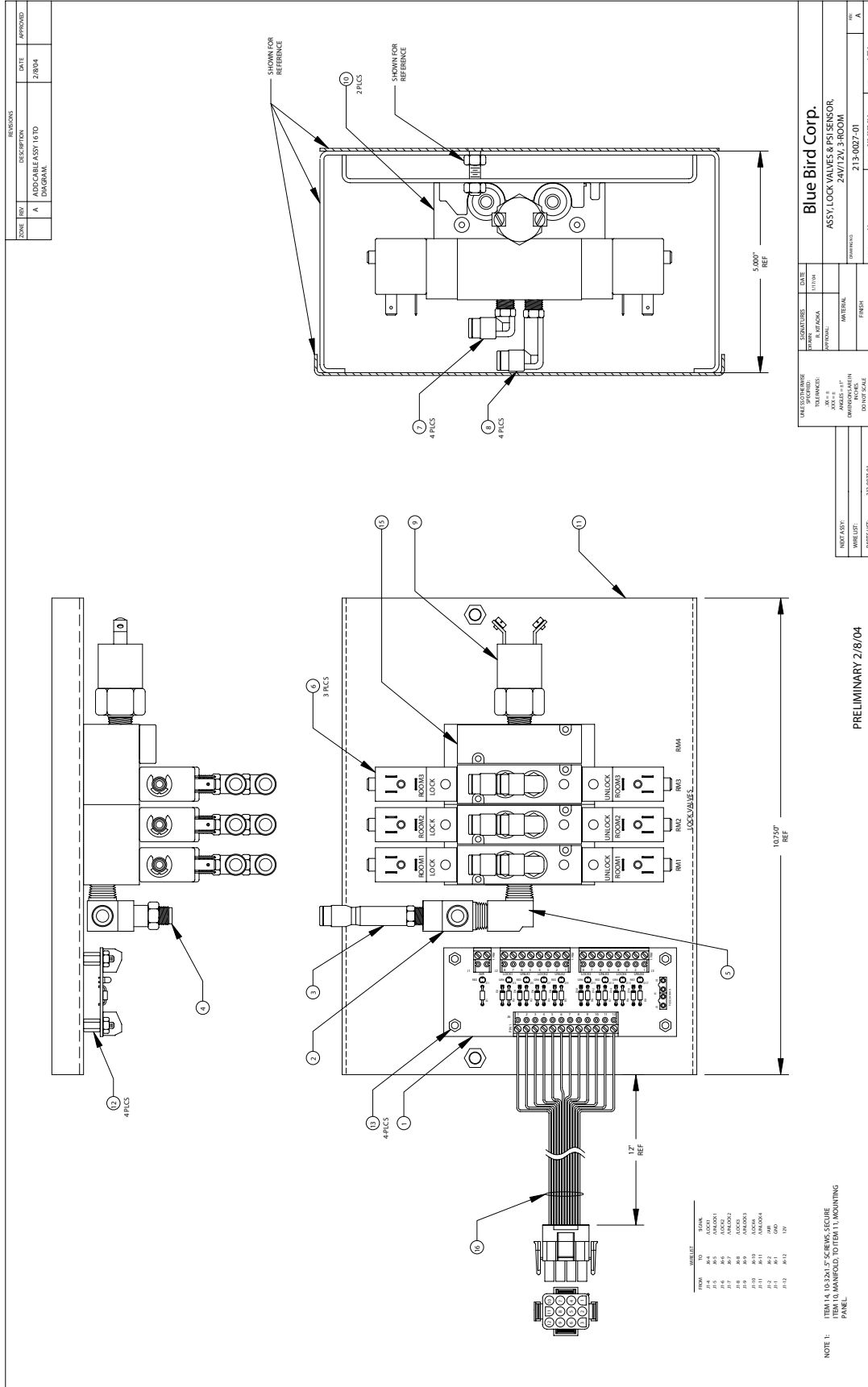



## 4-8 Heating Systems

There are three different heating systems in your coach. The Webasto hydronic heating system circulates a glycol-water mixture throughout the coach. The Operator can control four heating zones which direct the heat where it is needed. Further explanations of its operation and its advantages are discussed later in this section. The second heat source is a set of four heat pumps that are part of the Dometic roof top air conditioning units. These heat pumps provide heat at temperatures above 42°F. The third source of heat is four 120VAC electric heaters - two 1000 watt heaters are installed in the bathroom and kitchen, two 500 watt heaters are installed in Bay 2 and Bay 4.

### 4-8.1 Webasto Hydronic Heating System

Hydronic heating is comprised of a 50/50 water, antifreeze mixture that is ran through piping in the coach and continuously heated. There are zones placed throughout the coach that have fans attached to them. Using the two thermostats that are installed in the coach a user can control the heat zones for the coach. One thermostat controls the front of the coach and the other controls the back. The dividing line is the first pocket door at back of galley. The thermostats are located in the bedroom area and the front main galley area. This system is run off of the diesel and it may be preferred to use the 110 electric heating system when parked in a campground to save diesel provided the weather isn't too inclement. Some advantages of the hydronic system are:

- Continuous hot water
- Fuel efficient burner which burns all grades of diesel fuel, stove oil, furnace oil, and kerosene without any burner adjustments (not for use with gasoline.)
- Zero smoke, no carbon built-up, no fouling or smell.
- Copper and brass water jacket transfers more heat to the water and reduces the fuel consumption (three year warranty).
- High temperatures 310 stainless steel burner and marine stainless steel jacket.
- Quiet operation and low power consumption.
- All heaters are designed to operate on 10.5 to 15.0 V.D.C.
- All heaters are electric ignition, which draws 2 amps for 30 seconds on startup.
- Insulated enclosure for retaining heat and minimizing noise.
- Sealed combustion - 100% outside air is fan assisted to the combustion chamber and then exhausted outside, avoiding backpressure.
- Optional bottom exhaust - mostly used in motor homes.
- Includes four zone heating control for up to four thermostats.
- Completely modular and field serviceable (user friendly).
- Hookups and connections are easily accessible.
- Electronically controlled. Safety features include four-second shutdown in case of failure, LED digital readout on the electronic control panel for indicating faults, aquastats for monitoring water temperatures and a photodiode to monitor the flame.
- Complete with remote control panel with ON/OFF reset button, LED digital readout, and signal horn.
- Jumper for constant pump circulation (Automatic cycling when off).
- All heaters cycle at an operating temperature of 180°F (82°C) with overheat cutout set at 195°F (90.5°C).
- Air accumulator installed in the fuel line to collect air bubbles and prevent them from reaching the burner and causing nuisance shutdowns.

The Webasto heater utilizes a low pressure fuel system. The built in fuel pump draws fuel from the fuel tank up to a zero pressure regulator where it stops. An air accumulator is installed inline between the fuel pump and the regulator to trap any air bubbles from passing through the nozzle valve. For continuous bleeding, a return line can be run back to the fuel tank. A small compressor delivers air to an air aspirating nozzle. This nozzle draws fuel from the zero pressure regulator, mixing it with air through a venturi. This process produces a very fine mist of fuel into the burner providing complete combustion and very low emissions. This low pressure system allows the use of a larger fuel orifice, less clogging, less wear and less maintenance. Ignition is accomplished by a low draw ignitor, approximately 2 amps, for thirty seconds. Combustion air is drawn from outside so the heater can be installed in an air tight compartment or in the engine room without the fear of starving the heater of air or back venting the heater with the engine running.

## 4-8.2 Operation

### 4-8.2.1 Starting the Heater

The major steps in starting the heater are as follows:

1. Turn on the ON/OFF control switch, located on the remote indicator panel.
2. Turn up the zone thermostat to a setting higher than room temperature.
3. Start the heater by switching the service switch to ON. This switch is located on the side of the electronic control box located next to the unit in the bay.

### 4-8.2.2 Signs of Normal Operation

When the heater is operating normally:

- The ignitor will glow and the combustion air intake fan and the circulating pump begin to run. Whenever the pump is running, the green LED at the bottom of the LED display will be on.
- A few seconds later, the fuel pump starts delivering fuel to the regulator, the compressor turns ON, the fuel valve opens, and fuel is drawn to the air aspirating nozzle. The fuel is atomized and sprayed into the combustion chamber to start combustion.

After the ignition period (about 10 seconds), the ignitor shuts OFF, and the burner continues to operate. The heater will operate until all the zone thermostats are satisfied, or until the heater reaches its normal water operating temperature of 180°F. Once the normal operating temperature is reached, the burner itself will cycle off and the combustion fan will operate for an additional two minutes to purge the burner. If a zone thermostat, domestic water heater aquastat, or engine heat exchanger aquastat is not satisfied, the circulating pump will continue to operate. If a thermostat cannot be satisfied by the residual heat in the system, and the water temperature drops, the burner will restart and cycle until all thermostats are satisfied. Once all thermostats are satisfied, the heater will go through the two minute purge, and the circulating pump will ease. The circulating pump will operate if the remote switch and any zone thermostat or the domestic water aquastat are on. The circulating pump will be activated independently by the engine heat aquastat. After the heater has been running for a little while, the water outlet of the heater case should become warm. If the water hose leaving the outlet of the heater does not warm up immediately after the pump comes on, water is not circulating properly and air may be in the system. Turn the heater OFF immediately and check water circulation, refer to [Water Filling Procedure Section](#) later in this manual.

### 4-8.2.3 Main Control Board Operation

Once the heater is operating normally, you must check the operating safety functions of the main board. To make sure the safety functions work properly, place your hand over the air intake inlet to the compressor, this will snuff out the flame. If you continue to block the air intake inlet, the heater will try to restart two more times and failing to do so will shut it down, stopping the compressor and fuel pump. The board will display a code 7. Reset the fault and the heater will continue with normal operation.

### 4-8.2.4 Stopping the Heater (For Seasonal Purposes)

**WARNING!!! NEVER shut off the power to the heater using the circuit breaker or a master switch, or disconnect the battery while the heater is running. Doing so will cause serious damage to the heater, which will not be covered under warranty.**

To turn the Heater OFF, turn OFF the ON/OFF control switch, located on the remote indicator panel. The room thermostat or the remote indicator panel ON/OFF switch can be turned ON or OFF at any time, without harming the heater. The heater will automatically run through the purge cycle, which takes about two minutes.

### 4-8.2.5 Stopping the Heater (For Maintenance)

To shut down the heater totally, for maintenance purposes:

1. Turn OFF, the ON/OFF control switch, located on the remote indicator panel.
2. Turn OFF, the service switch on the electronic control box.
3. Wait until the heater has completed the purge cycle and turned itself OFF.
4. Disconnect the power supply.

### 4-8.2.6 Resetting the Fault

When a fault occurs and has been corrected, you can reset the fault by switching the service switch on the side of the main control box located next to the unit in the bay, or the remote control switch OFF, then ON again. This will reset the fault and the diagnostic code.

### 4-8.2.7 Stopping the Heaters (When coach is left for extended periods of time)

There are two heating systems supplied with the motor home. The Hydronic heat system has two thermostats located in the bathroom and the galley. The bay electric heater has a thermostat located in bay 2, right. If the Auto Gen-Start feature on the Inverter is Off and coach is unused for a period of time, (more than a day), be sure that all three thermostats are set to the full Off position (the thermostat Off state has a detent position at the end of the full counterclockwise rotation). If not turned to full Off position and motor home gets below 50°F, the hydronic heater pump turns On and the bay electric heaters turn On, thus draining the battery. To use the Auto Gen-Start function on the inverter, refer to [Inverter Section](#) section of this manual.

## 4-8.3 Heat Exchanger Operation

If your motor home is equipped with a heat exchanger to pre-heat your engine and recycle waste engine heat, follow these procedures.

To pre-heat your engine: Turn on the heater by a manual switch or timer wired to the jumper W-W terminal, located in the control box. If the heat exchanger is mounted upright, close to and near the bottom of the engine, it will transfer heat to the engine's cooling system through gravity circulation. A more positive solution is to install a pump on the engine side of the heat exchanger wired to the A-A pump terminals located in the control box, on the main board in series with a master switch.

To use waste engine heat for space and domestic water heating:

1. Install a switch, and/or an aquastat (part #1027), on the engine supply line to the heat exchanger, and wire to the A-A terminals on the main control board.
2. Turn OFF, the ON/OFF control switch, located on the remote indicator panel. This will stop the burner from operating, but all other heater functions will operate normally.
3. Start your engine.
4. When the engine aquastat heats up to its preset temperatures, it will automatically switch on the circulating pump of the heating system. All other functions of the system will operate normally.
5. The circulating pump will continue to operate until the engine aquastat has cooled down. A manual switch can be wired in series with this aquastat to shut down the pump sooner if required.

## 4-8.4 Domestic Water Operation

If your water heater is connected to the hydronic heating system and its controlling aquastat (part #1024) is wired to the W-W terminals on the main board, it will cycle the heater and the water pump. A manual switch can be wired in series with this aquastat to shut down the operation if desired. A bypass loop can be plumbed in for summer operation.

### CAUTION!!

Where there is a chance of contamination of your domestic water when using a heating system, use antifreeze specifically intended for hydronic heating systems. Inhibited propylene glycol is recommended. Do not use automotive, ethylene glycol, or any undiluted or petroleum based antifreeze as they can cause severe personal injury should antifreeze leak into your potable water supply. Double wall heat exchangers are available for potable water which will prevent contamination in the event of an internal leak.

## 4-8.5 Troubleshooting

### 4-8.5.5 Overview

The electronic board consists of a flash micro controller programmed to monitor the timing and safety function of the heater. Each time the board is energized by a call for heat, it will check its own circuits for any problems. Should a problem exist, the board will shut down.

You can easily monitor your Webasto heater's operation by checking the electronic control box. Any fault or problem will be immediately picked up by the control board and an LED diagnostic code indicator will light up to pinpoint the fault. Once the fault has been corrected, it can be reset by switching the service or remote switch OFF, then ON again. The diagnostic codes are described below.

### 4-8.5.6 Power On (Green)

The POWER ON indicator is lit whenever the service switch on the control box is ON and if the remote panel is switched ON, a small red LED near the lower right hand side of the digit on the remote panel will also glow. If this light does not come on, check to see if the service switch is ON.

If the power on light does NOT come on:

Check for a blown fuse.

### 4-8.5.7 Burner On

No diagnostic code will be displayed on the main board or the remote panel when the burner is ON and operating normally. A small red LED will glow near the right hand side of the digital readout on the main board located on the unit in the upper left hand corner, indicating it is ON.

### 4-8.5.8 - Service Switch Off

The service switch is switched OFF.

- The burner will shut down if it has been running.
- The diagnostic code,  will be displayed.
- The control board will purge the system with the combustion fan and circulating pump for two minutes. At the end of the purge period, the system will power down and will go into a low power consumption mode (10mA max.). There will not be any display or LED's lit.

### 4-8.5.9 - Remote Switch Off

The remote panel is switched OFF.

- The burner will shut down.
- The diagnostic code,  will be displayed.
- The control board will purge the system with the combustion fan and the circulating pump for two minutes.

If the remote switch is put in the ON position, the control board resumes operation and a small red LED glows near the lower right hand corner of the digit. If there is no diagnostic code displayed or small LED glowing:

1. Make sure the service switch is ON.
2. Make sure the remote switch cable is plugged into the control box and remote switch.
3. Make sure the remote rocker switch is working.
4. Check the cable continuity.

### 4-8.5.10 – Heater Cycling (Normal Operation)

The operating aquastat installed on the water jacket has been satisfied.

- The burner will shut down.
- The diagnostic code,  will be displayed.
- The control board will purge the burner with the combustion fan for two minutes and then stop. The circulating pump will run until the last thermostat is satisfied, then will purge for two minutes and stop.
- To maintain the system temperature the operating aquastat will cycle the burner off at 185°F (85°C) and on again at 150°F (65°C).
- If the heater cools and fails to resume operation and the diagnostic code continues to be displayed, the aquastat is faulty or has an open connection.

### 4-8.5.11 – Thermostats Off (Normal Operation)

All thermostats and aquastats are satisfied.

- The burner will shut down.
- The diagnostic code,  will be displayed.
- The control board will purge the system with the combustion fan and the circulating pump for two minutes. When any thermostat or aquastat calls for heat, the heater will resume normal operation.
- If the heater fails to resume operations, check the thermostat and their connections.

### 4-8.5.12 – Voltage Low or High

The battery or power supply voltage is below 10.5Vdc or above 15.5Vdc.

- The burner will shut down.
- The diagnostic code,  will be displayed.
- The buzzer will sound for 10 seconds.
- The control board will purge the system with the combustion fan and circulating pump for two minutes while it is checking if the voltage fault is still present.

If the voltage fault has cleared, the control board resets the alarm and restarts the burner. If the condition has not cleared by the end of the purge period, the diagnostic code remains displayed. The control board continues to check the voltage every half hour until the voltage fault clears and then restarts the burner. To manually reset the fault, switch the service switch or the remote panel switch OFF then ON again.

### 4-8.5.13 – Overheat

The high temperature limit has been reached.

- The burner will shut down.
- The diagnostic code,  will be displayed.
- The buzzer will sound for 10 seconds.
- The control board will purge the system with the combustion fan and the circulating pump for two minutes while it is checking if the overheat condition exists. If the condition exists, the diagnostic code will continue to be displayed.
- In order to restart the burner, first check the circulating pump, the level of the coolant, and the movement of the coolant while the circulating pump is running. Then reset the fault after the water has cooled down by switching the service switch or the remote panel switch OFF then ON again. If it does not reset, check for faulty aquastat and proper ground.

If a number diagnostic code lights up and the heater is not in an overheat condition, check the ground from the heater to the battery. The ground should be a minimum 10 AWG and connected directly to the battery.

### 4-8.5.14 2 – Fuse Blown

One of the fuses on the control board has blown.

- The burner will shut down.
- The diagnostic code, 2 will be displayed.
- The buzzer will sound for 10 seconds.
- The control board will purge the system with the combustion fan and the circulating pump for two minutes while it is checking for a blown fuse.

If a blown fuse exists, the diagnostic code will continue to be displayed.

- In order to restart the burner, replace any blown fuses with one of the proper size. Then reset the fault by switching the service switch or the remote panel switch OFF then ON again.

### 4-8.5.15 3 – Fuel Pump/Solenoid

The fuel pump or fuel solenoid has shorted.

- The burner will shut down.
- The diagnostic code, 3 will be displayed.
- The buzzer will sound for 10 seconds.
- The control board will purge the system with the combustion fan and the circulating pump for two minutes.
- In order to restart the burner, check the fuel pump and solenoid for a short circuit. Then reset the fault by switching the service switch OFF and ON again.

*The remote panel switch does not reset short circuit faults.*

### 4-8.5.16 4 – Ignitor

The ignitor is open or shorted.

- The burner will shut down.
- The diagnostic code, 4 will be displayed.
- The buzzer will sound for 10 seconds.
- The control board will purge the system with the combustion fan and the circulating pump for two minutes.
- In order to restart the burner, check the ignitor and connections. Then reset the fault by switching the service switch or the remote panel switch OFF then ON again if the ignitor is open or by the service switch only if the ignitor is shorted.

*The remote panel switch does not reset a short circuit fault.*

### 4-8.5.17 5 – Combustion Fan

The combustion fan is open or shorted.

- The burner will shut down.
- The diagnostic code, 5 will be displayed.
- The buzzer will sound for 10 seconds.
- The control board will purge, with the circulating pump for two minutes.
- In order to restart the burner, check the combustion fan. Then reset the fault by switching the service switch or the remote panel switch OFF then ON again if the combustion fan is open or by the service switch only if the combustion fan has shorted.

*The remote panel switch does not reset a short circuit fault.*

### 4-8.5.18 6 – Water Pump

The water pump is shorted.

- The burner will shut down.
- The diagnostic code, 6 will be displayed.
- The buzzer will sound for 10 seconds.
- The control board will purge with the combustion fan for two minutes.
- In order to restart the burner, check the water pump. Then reset the fault by switching the service switch OFF then ON again.

*The remote panel switch does not reset a short circuit fault.*



### 4-8.5.19 7 – Flame Out

The flame went out or did not ignite.

- The burner will shut down.
- The diagnostic code, 7 will be displayed.
- The control board will try to restart the burner two more times. After three unsuccessful ignition attempts, the buzzer will sound for 10 seconds.
- The control board will purge with the combustion fan and circulating pump for two minutes. The diagnostic code 7 will continue to be displayed.

The single most common reason for flame out faults is when air gets into the fuel system. This is normally caused by loose fittings or when your fuel supply is teed off a fuel line used by your engine or generator. As air accumulates and passes through the nozzle, it interrupts the fuel and shuts down the burner. When this happens, it may be necessary to reset the fault a few times to ensure all air has passed through the system. If the burner resumes normal operation, you must find the source of the air leak, otherwise, this fault will continue to occur. An Air Accumulator has been installed to collect the air before it reaches the nozzle. Check regularly and bleed if necessary. Air which is collected is an indication of a leak somewhere in the fuel system.

1. Check the fuel supply. The fuel pump will chatter if there is no fuel or when air is passing through the pump. Check the Air Accumulator for air and bleed if necessary. Check connections between the fuel tank and fuel pump and the regulator and nozzle for air leaks. Find source of air entry and repair. Make sure the nozzle or fuel filter is not clogged.
2. Check the air line hoses for any restriction of air flow through the compressor. Restrictions may be caused by a crimped hose, clogged air filter, or a loose or leaking air hose from the compressor outlet to the nozzle. Check the air filter inlet for any obstructions.
3. Make sure the air pressure of the compressor with the nozzle installed, is at 8 to 90 psig for CO-20/32 models and 10 to 12 psig for CO-45/65, and 14 to 16 psig for CO-85/105 models.
4. Check for negative pressure in the area around the heater. When the engine is running, it can draw air back through the heater's exhaust pipe. All intake air and exhaust connections must be tight.
5. Check for restrictions or leaks in the combustion air intake hose or exhaust pipe.
6. Check for open circuit on fuel pump/solenoid and compressor.
  - To restart the burner, check the fuel supply, check for air in the fuel line, and clean the nozzle. Then reset the fault by switching the service switch or the remote switch OFF then ON again.
7. If when reset, the board shuts down without trying to restart the burner the board is defective.

### 4-8.5.20 8 – Compressor

The air compressor has shorted.

- The burner will shut down
- The diagnostic code, 8 will be displayed.
- The buzzer will sound for 10 seconds.
- The control board will purge the system with the combustion fan and the circulating pump for two minutes.
- In order to restart the burner, check the air compressor. Then reset the fault by switching the service switch OFF then ON again.

*The remote panel switch does not reset a short circuit fault.*

### 4-8.5.17 – Bypass Mode

The bypass mode is a service feature to be used by authorized service personnel only. The bypass mode overrides the remote switch, voltage fault, fuse blown fault, flame out fault, open ignitor fault, open fan fault, and thermostats. All these safety devices will be bypassed for five minutes.

- While in the bypass mode, the diagnostic code,  will be displayed and the Power ON LED will flash rapidly.
- If the heater cycling aquastat is satisfied or the overheat limit is reached, the burner stops and purges for two minutes while displaying the diagnostic codes: C-heater cycling or 1-overheat, and the Power ON LED flashes slowly. You must wait for the heater to cool before continuing in the bypass mode. The bypass mode times out in five minutes. After the first three minutes running, it automatically purges for the last two minutes.

### 4-8.5.18 Water Pump On (Green)

The green light located directly under the LED digit on the main board turns on whenever the circulating water pump is energized.

### 4-8.5.19 Remote Panel

The remote panel consists of an ON/OFF reset switch, an LED diagnostic digit, and fault buzzer. The diagnostic digit matches the main control board which refers to the diagnostic codes as explained previously in this section. A small red LED glows when the switch is on, which also indicates that the service switch is ON. The small buzzer sounds for 10 seconds to alert you of a fault.

### 4-8.5.20 LCD Readout Remote Panel (Optional)

This panel displays the diagnostic explanation which matches up to the diagnostic code on the main board. A small buzzer sounds for 10 seconds to alert you of a fault.

### 4-8.5.21 Flame Sensor Module

The Flame Sensor consists of a sealed module with a photodiode aimed at the flame, a red LED indicator light and 3 wires, white (+), black (-), and green (signal) connected to the main board. Under normal operating conditions whenever the burner ignition begins, the red LED flashes once indicating the white and black wires are connected and the module is receiving power and working properly. Once the burner is ignited, the LED begins to flicker like a flame. If for any reason the flame is extinguished, the flickering stops and the board shuts down the heater. If the green (signal) wire is disconnected, the board shuts down. If all wires are properly connected with module flashing and the board still shuts down, diagnostic code  Flame Out, the board may be defective.

### 4-8.5.22 Reduced Output

The heater may run without faulting, but at a reduced output. If this is noticed, it could be caused by the following:

1. High altitude
2. Dirty nozzle
3. Defective regulator
4. Too small a nozzle
5. Poor water circulation
6. Ash deposit in combustion chamber

### 4-8.5.23 Smokey, Smelly Exhaust

The heater may run without faulting, but you may experience signs of soot, exhaust smoke and/or a pungent smell. This is usually caused by the wrong fuel to air mixture. This can be affected by the following:

1. Low voltage
2. High altitude
3. Dirty compressor air filter
4. Low compressor air output
5. Restricted combustion air flow (intake hose/exhaust hose/combustion chamber)
6. Low combustion fan output (defective motor/wrong rotation/dirty fan blade)
7. Partially clogged grooves in nozzle distributor.

### 4-8.5.24 Hot Water is Coming Out Cool

This may be a sign that the Mixing Valve is not set to the proper setting. Look through the 3/8" x 1" Inspection Slot on the front of the Webasto Heat case, if setting is not at 4, it will need to be adjusted.

To adjust setting, remove cover from case and manually turn knob to highest setting (4), replace cover.

**NOTE:** If there is no slot on the Webasto case then this is not the cause of the cool water. Unit may need to be serviced.

## 4-8.6 Maintenance

### 4-8.6.1 The First Few Weeks

About two weeks after your Webasto heater has been running, you should conduct a general inspection of the entire system. Check for any leaks in the exhaust, fuel, or water systems. Tighten all clamps.

### 4-8.6.2 Adding Antifreeze

Once the system has been filled with water and purged of all air during the installation procedure, you need to operate the heater at normal temperatures and then check for water leaks. If you do not find any, add antifreeze to lubricate the pump and prevent the water system from corroding or freezing in cold weather. To do this see [Water Filling Section Procedures](#) later in this manual.

#### CAUTION!!

Where there is a chance of contamination of your domestic water when using a heating system, use antifreeze specifically intended for hydronic heating systems. Inhibited propylene glycol is recommended. Do not use automotive, ethylene glycol, or any undiluted or petroleum based antifreeze as they can cause severe personal injury.

**IT IS VERY IMPORTANT THAT YOU NEVER USE WATER ONLY AS A COOLANT.**

We recommend that you add a mixture of 50% water and 50% antifreeze. NEVER use more than a 50/50 mixture, since the added viscosity of the antifreeze solution will cause circulation problems. Your antifreeze/water mixture should be changed every three years. Antifreeze does wear out and can become very acidic.

A coolant conditioner should be added to the water system, to keep the coolant alkaline and not acidic, see section [Protecting Hydronic Heating Systems](#) later in this manual. These inhibitors also prevent the coolant from forming calcium scales. Conditioners are available from diesel engine manufacturers to maintain water stability and prolong heater life. If a conditioner is not installed in your system, check the pH level yearly. The components inside the heater should not normally require maintenance, except for periodic checks for obvious problems, such as leaks or overheating.

### 4-8.6.3 Nozzle

Nozzle problems such as clogging results in a poor flame, small and blue. Carefully disassemble. Hold nozzle and turn stem counter clockwise. Clean distributor orifice and air slots of any debris using solvent and high pressure air. Check O-rings for nicks and replace if in doubt. A leaking O-ring allows air into the fuel causing popping of the flame.

### 4-8.6.4 Fuel Lines and Filter

You should check your filter every season to determine if it needs replacement. The frequency depends largely on the quality of fuel you've been using.

### 4-8.6.5 Combustion Chamber

The quality of the fuel varies and some ash is left in the chamber after combustion. The burner and combustion tube must be removed and the combustion chamber vacuumed clean every 1000 hours. If this is neglected, the exhaust becomes restricted and causes the combustion chamber to burn out. The exhaust pipe should be checked and also be vacuumed, if required.

### 4-8.6.6 Checking Hoses and Tubes

Every so often, check all water hoses and tubes for leaks or weak points. Tighten all clamps and replace any sections of worn hose immediately.

#### CAUTION!!

Never let the water pump run dry. This causes irreparable damage to the pump and voids the warranty.

### 4-8.6.7 Electrical System

The electronic control panel should not normally require servicing, except for the following:

- Make sure that all your connections are secure.
- Periodically, do a voltage test to ensure that you are getting 12 volts from the battery.
- Check for corrosion of wires.

### 4-8.6.8 Recommended Spare Parts

Like any piece of machinery, your Webasto heater will need servicing from time to time. A suggested maintenance schedule can be found in [Maintenance Schedule Section](#) below. The following is a list of parts recommended to have on hand.

Description	Part No.
Fuel filter cartridge	6021
Air filter	6018
Fuel nozzle (# for model CO 45)	14017
Fuel nozzle "O" ring	14025
Photocell (Board versions 5-10)	16002
Photodiode (Board version 11/12)	16003
Flame Sensor (Board version 2000 and 2001)	16004

Over a period of time, operational parts of the heater will wear out and need replacing:

- Air compressor
- Fan Motor
- Ignitor
- Operating and High Limit Aquastat

### 4-8.6.9 Maintenance Schedule

Maintenance Item	Maintenance Frequency	Service Required
Fuel/Water Hoses	Seasonally	Inspect for leaks and weak points
Hose Clamps	Seasonally	Inspect for corrosion
		Tighten if Loose
Combustion Chamber and Exhaust	1000 Hours	Vacuum Clean
Fuel Filter	Seasonally	Inspect for Cleaning or Replacement
Nozzles, Distributor Orifice, Air Slots and O-Rings	Seasonally or Every 2000 Hours	Cleaning and Inspection for Wear and Damage
Exhaust System	Seasonally	Inspect for Leaks and Corrosion
Coolant Mixture	36 Months	Replace
	12 Months	pH Level for Acidity
Electronic Control Panel	Seasonally	Voltage Test/Inspect for Corroded Wires
Air Compressor, Fuel Pump, Combustion Fan, Motor	Seasonally	Inspect for Leaks, Corrosion and Wear

### 4-8.6.10 Protecting Hydronic Heating Systems

The advantage of closed hydronic heating systems is that as long as there are no leaks, (i.e., no need for constant make-up water), the fill neutralizes (that is, it reaches equilibrium). The long term result is minimal scale build-up and insignificant corrosion since after operating for a period of time, most oxygen has been “starved” out of the boiler fill water. While boiler fill water treatments have their place, leak prevention is the single most important preventative maintenance item.

Regular maintenance and prompt repair of leaks, combined with a one time application of appropriate inhibitors, can help you enjoy problem-free heating. Since it is difficult to guarantee that a hydronic heating system will never leak, corrosion inhibitors and scale inhibitors added to “fresh” boiler fill water can act as low cost “insurance” for hydronic systems.

#### Causes of Scale

Tap water is the most typical source selected for boiler fill water. Water contains dissolved solids such as magnesium and calcium which when heated becomes much less soluble and forms scale. Scale comes out of solution in the largest amounts where the temperature is highest in the system (i.e., the boiler heat exchanger). As the scale builds up, noise and cold spots develop since scales plug up water channels and acts as an insulator that impedes proper heater transfer.

#### Acidity and Corrosion

Corrosion is the result of metal oxidizing (that is, metals reacting with oxygen-rich boiler fill water). The acidity of any liquid (including water) is a good indicator of how much corrosion will actually take place. As a rule of thumb, boiler fill water should have a pH greater than 7 and less than 10.5. The key to preventing corrosion is to make sure that the heating system is free of leaks and there is no need to replace it with fresh, oxygen rich boiler fill water. Corrosion inside a hydronic heating system stops quite quickly as the fill water stabilizes and becomes oxygen-starved. The pH should be measured at least annually.

Since most hydronic heating systems are comprised of different metals (e.g., iron, copper, etc.) and since boiler fill water is an electrolyte (that is, it will conduct electrical current), electro-chemical reactions (“galvanic” reactions) can take place. As the fill water stabilizes, however, it becomes a very weak electrolyte, so galvanic corrosion rarely becomes a problem – as long as the system remains leak-free.

#### Preventative Treatments

Corrosion and scale inhibitors are relatively inexpensive. Ideally, they should be applied, once only, at the time of a new installation or whenever a system has been completely drained. Boiler water treatment specialists almost unanimously agree that the prevention of leaks and the elimination of the need for frequent boiler water make-up are top priorities for hydronic systems.

### 4-8.6.11 Water Filling Procedure

After your system has been completely installed, filled with straight water, purged of all air, and operating for a period of time at normal operating temperatures, you should now double check all connections for leaks. If no leaks are found, the system can be drained and filled with a 50/50 mixture of antifreeze and water.

**CAUTION!!**

Where there is a chance of contamination of your domestic water when using a heating system, use antifreeze specifically intended for hydronic heating systems. Inhibited propylene glycol is recommended. Do not use automotive, ethylene glycol, or any undiluted or petroleum based antifreeze as they can cause severe personal injury.

To fill the system use a separate self priming pressure pump with a hose on the suction side. Put the hose into a 5 gallon container. Remove the systems hose from the outlet of the expansion tank, which is feeding the systems circulating pump and attach it to the outlet of the self priming pressure pump. Remove the hose from the inlet of the expansion tank and hang it into the 5 gallon container.

Make a final check to ensure all of the air vents and drains are closed. Pour a mixture of antifreeze and water into the container and start the pump. As the mixture is pumped out, slowly add more mixture keeping the level above the inlet of the suction hose until all air has been expelled and the mixture starts coming out of the return hose hanging in the container. This flushes the system of any debris and purges the lines of air. Continue to run the pump for about 15 minutes.

When no more air is being expelled, stop the pump and reconnect the lines to the expansion tank. Top off the expansion tank with the mixture and turn on the system's circulating pump with the jumper, located on the main control board just right of the pump fuse, marked "Circ. Pump Override". When the jumper is on, the pump will run continuously and the bottom LED will be lit.

Check for a good flow through the expansion tank and double check all joints for leaks. Open and close all air vents to eliminate any remaining air bubbles. Recheck the mixture level and circulation in the expansion tank.

**CAUTION!!**

Make sure you have a good, quiet circulation of water through the heater. Check the pump to make sure it does not run dry. If the heater has air pockets trapped in the water jacket when it is turned on, it could overheat and damage the unit. None of this is covered by warranty.

## 4-9 Air Conditioning/Heat Pump

### 4-9.1 System Description

Air conditioners are located in the living room and bedroom areas. A wall mounted master thermostat is located in the dinette area to control all units. Directions for operation can be found in "Comfort Control Center" section. Remote temperature sensors are located in the kitchen/dinette area and bedroom. The air conditioners are operable from 120 VAC source (generator or shoreline power). Each air conditioning unit is also a heat pump.

There are four heat pump units mounted on the roof of the coach. These units operate at 42°F and above.

Condensate Drains - Separate drain lines are provided for each air conditioning unit to route condensation from the roof to the ground through the body side walls.

### 4-9.2 Electric Heat

An electric forced air heater is located in the bath, controlled by remote thermostat. A second electric heater is located in the kitchen.

### 4-9.3 Comfort Control Center

The coach comes equipped with Duo-Therm's Comfort Control Center™. The Comfort Control Center has been designed for you to easily operate all the air conditioning and gas heating appliances found in the coach from one location.

In order to familiarize yourself with the operation of the Comfort Control Center, the following diagram along with the accompanying text will explain all the functional characteristics of the system.

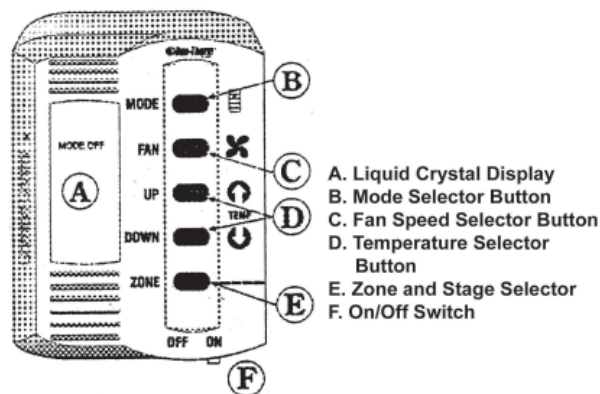

**A. LIQUID CRYSTAL DISPLAY** - Your Comfort Control Center is equipped with a liquid crystal display (LCD) that identifies the mode of operation, the temperature set-point, the zone identification and the fan speed. The Comfort Control Center is designed to accept and control many varied air conditioning and gas heating appliances. When you begin to first operate your Comfort Control Center, you will see that the LCD readout will only show the options available based on the appliances installed on your vehicle. An incandescent light will illuminate the LCD area when a selector button is pushed for easy reading at all times.

**B. MODE SELECTOR BUTTON** - Modes of operation available are: OFF, FAN ONLY, COOL, HEAT PUMP, FURNACE, HEAT STRIP and AUX. HEAT. Remember, the LCD readout will only show the options available based on the appliances installed on your vehicle. To select the mode of operation, momentarily depress the MODE push-button. You will need to continue to depress and release the button until the desired mode is shown in the LCD readout area on the Comfort Control Center.

To determine the Comfort Control Center options available to you, depress and release the MODE push-button until it goes through all selections.

**C. FAN SPEEDS** - Possible available fan speeds are: LOW, MEDIUM, HIGH and AUTO. To select the desired fan speed, momentarily depress the FAN push button. Continue to depress and release the FAN button until the desired fan speed is shown in the LCD readout area of the Comfort Control Center.

**D. TEMPERATURE SELECTOR BUTTONS** - The temperature Set-point range is from 40° to 99°F or 4° to 37°C. Determination of Fahrenheit or Celsius standard is done at the time of the manufacturer's installation of the Climate Control Center. To set the temperature at the desired comfort level, simply depress and release the UP or DOWN push-button until the desired temperature is shown in the LCD readout area of the Comfort Control Center.

- E. ZONE SELECTOR BUTTON** - The number of ZONES installed on the coach directly corresponds with the number of heating/cooling systems installed. The 450LXi has ?? Zones (?? Comfort Control Centers).
- F. ON/OFF SWITCH** - The ON/OFF switch is located on the lower right hand edge of the Comfort Control Center. Move the lever from side to side to change status.

### 4-9.3.1 Operation

The Comfort Control Center allows the freedom of controlling the vehicle's temperature to provide a comfortable environment. With just a few simple steps, the operator can control which mode of operation to use, the vehicle temperature and the fan speeds.

#### A. FAN ONLY MODE OF OPERATION

1. Begin by placing the power switch on the lower right hand edge of the Control Center on the ON position. To do this, simply move the lever to the right.
2. Momentarily depress and release the MODE push-button until the FAN ONLY indicator on the Liquid Crystal Display (LCD) is illuminated.
3. Momentarily depress and release the FAN push-button until the desired fan speed indicator (LOW, MED, HIGH, AUTO) is illuminated. If your vehicle is equipped with a heat pump air conditioning system, the selection choice will be LOW, HIGH or AUTO.
4. After approximately 5 seconds, the selected fan speed will come on. The MODE and FAN speed you have selected will remain shown in the LCD area of the Control Center until the selection is changed.
5. If The coach contains more than one ZONE, depress the ZONE push-button to select ZONE 2, and repeat procedures from step two above. Repeat entire procedure for each additional zone.

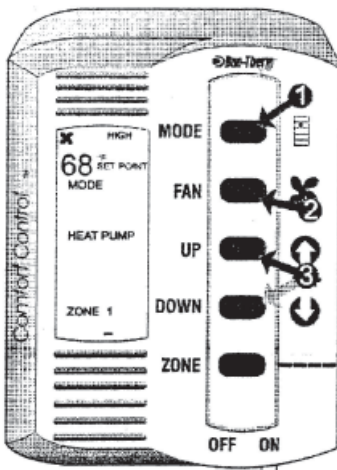
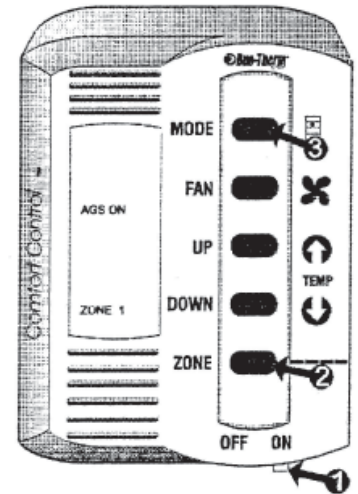

#### B. COOLING MODE OPERATION

(To set cooling temperatures and fan speeds on Duo-Therm Air Conditioners and the cooling mode of Duo-Therm Heat Pumps.)

1. Momentarily depress and release the MODE push-button until the COOL indicator on the LCD is illuminated.
2. Depress and release the FAN push-button to select your desired fan speed (LOW, MEDIUM, HIGH or AUTO). If the coach is equipped with a heat pump or a dual basement air conditioner system, selection choice will be LOW, HIGH or AUTO.
3. Depress and release the UP push-button to increase the temperature or the DOWN push-button to decrease the desired temperature. The final selected SET-POINT will be displayed in the LCD area of the Comfort Control Center.
4. After a delay of approximately 2 minutes the air conditioner's compressor will come on and the cooling process will begin. Once the room temperature reaches the selected SET-POINT, the compressor will cycle off. Once the Comfort Control Center senses the need for cooling, the compressor will restart in approximately two minutes. At this point, the fan will either:
  5. continue to operate in the single selected fan speed or,
  6. cycle OFF and ON with the compressor if the AUTO fan speed has been selected.

If The coach contains more than one ZONE, depress the ZONE push-button to select ZONE 2, and repeat procedures from step two above. Repeat entire procedure for each additional zone.



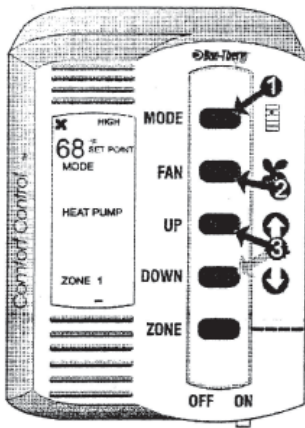

**NOTE:** See Defrost Cycle and Optional Automatic Generator Start (AGS) for additional Special Heat Pump Features.

### C. HEAT PUMP OPERATION

(To set heating temperatures for coaches equipped with a Duo-Therm rooftop heat pump. To operate cooling mode with a heat pump, see “B. Cooling Mode Operation” found previously.)

1. Momentarily depress and release the MODE push-button until the HEAT PUMP indicator on the LCD is illuminated.
2. If the fan speed was not previously set, do so by depressing and releasing the FAN push-button to select the desired fan speed.
3. Depress and release the UP push-button to increase the temperature or the DOWN push-button to decrease the desired temperature. The final selected SET-POINT will be displayed in the LCD area of the Comfort Control Center.
4. After a delay of approximately 2 minutes the heat pump’s compressor will come on and the heating process will begin. Once the room temperature reaches the selected SET-POINT, the compressor will cycle off. Once the Comfort Control Center senses the need for heating, the compressor will restart in approximately two minutes. At this point, the fan will either:
  - a. continue to operate in the single selected fan speed, or,
  - b. cycle OFF and ON with the compressor if the AUTO fan speed has been selected.
5. If The coach contains more than one ZONE, depress the ZONE push-button to select ZONE 2, and repeat procedures from step two above. Repeat entire procedure for each additional zone.

### D. FURNACE MODE OPERATION

(The coach is equipped with a hydronic heating system connected to the Comfort Control Center)

1. Momentarily depress and release the MODE push-button until the FURNACE indicator on the LCD is illuminated.
2. The A/C fan does not operate in the FURNACE mode.
3. Depress and release the UP push-button to increase the temperature or the DOWN push-button to decrease the desired temperature. The final selected SET-POINT will be displayed in the LCD area of the Comfort Control Center.
4. Your Duo-Therm air conditioning system will not operate when the Comfort Control System is in the FURNACE mode. For cooling, change the MODE to COOL.
5. If The coach contains more than one ZONE, depress the ZONE push-button to select ZONE 2, and repeat procedures from step two above. Repeat entire procedure for each additional zone.

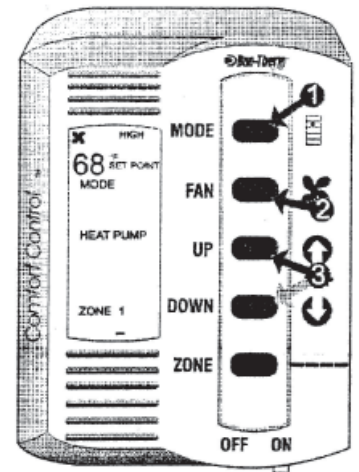

## 4-9.3.2 Special Control Features

### A. AUTO FAN

When AUTO FAN is selected, the fan speed will be determined by the mode you are in.

1. COOL MODE - In the COOL mode, which is the air conditioning mode, the fan will automatically select the speed depending upon the difference between the temperature SET-POINT and the room temperature.

When the difference is:

8° or more	The fan will operate on HIGH
4° to 8°	The fan will operate on MED
4° or below	The fan will operate on LOW

- 2. COOL MODE** (Heat Pump units) - If the coach is equipped with a Duo-Therm Heat Pump unit, the fan will automatically select the fan speed depending upon the difference between the temperature SET-POINT and the room temperature.

When the difference is:

Greater than 4°            The fan operates on HIGH

4° or less                 The fan operates on LOW

- 3. HEAT PUMP MODE** - When HEAT PUMP mode is selected, the fan will start running in the LOW speed.

- 4. HEAT STRIP MODE** - When HEAT STRIP mode is selected, the fan will start running in the LOW speed.

- 5. FAN ONLY MODE** - In the FAN ONLY mode, the fan will start running in the LOW speed

### B. REFRIGERANT COMPRESSOR TIME DELAY

A time delay of approximately two minutes occurs any time the compressor is required to begin the cooling or heat pump cycle.

### C. POWER INTERRUPTION

In the event that power to the air conditioner or control is interrupted, the system will restart with the same settings you have previously set.

### D. ZONE CONTROL

Your Duo-Therm Control Center will operate cooling and heating appliances which your vehicle manufacturer has designed to heat or cool different areas (ZONES) of your coach. The Comfort Control Center will advise you if your coach has multiple ZONES, by showing ZONE 1,2,3 or 4 illuminated in the LCD readout. In the event your coach has multiple zones designed, you have the freedom of selecting the MODE of operation for each zone independently. To change from one zone to another, depress the ZONE push-button. Each time you depress and release this push-button, the indicator will change the zone data displayed. The zone number flashing indicates zone being programmed. The zone number will flash for approximately 30 seconds unless another zone is selected or programming has been completed. At this time the number will stop flashing and the display light will go out. When all zones have been programmed, the zones in operation will be underlined. To program each zone, simply repeat the programming steps shown in the operation section of this manual.

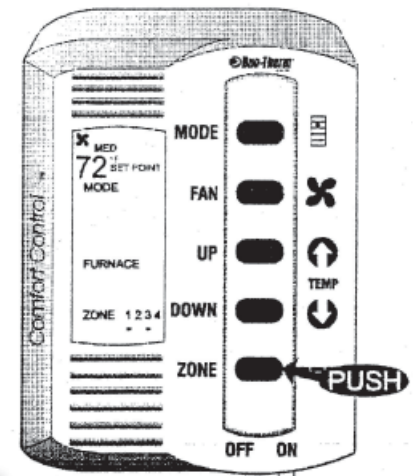

**Please note: The Comfort Control Center will prevent operating FURNACE and COOL or FURNACE and HEAT PUMP at the same time.**

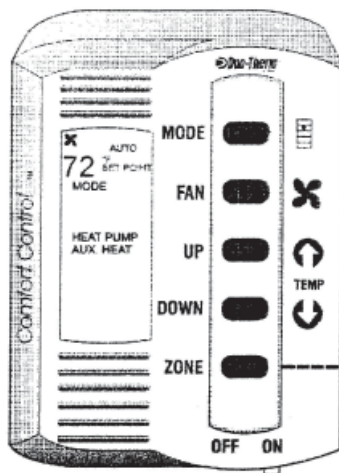

### E. AUX. HEAT

When in the HEAT PUMP mode, if the outside ambient temperature is measured to be below 30°F, the control will automatically select the FURNACE operation. When this happens, the AUX. HEAT and the HEAT PUMP indicators on the LCD will illuminate. Once the outside ambient temperature is measured above 38°F, the control will return to the HEAT PUMP operation. If the coach does not contain a furnace, and there is a Duo-Therm Heat Pump, once the outside ambient temperature goes below 30°F, the system will shut down until the outside temperature reaches 38°F, at which time the Heat Pump will resume operation.

### F. DEFROST CYCLE

This cycle is active during HEAT PUMP operation and allows the heat pump to operate down to 30°F. When the outside ambient temperature is less than 42°F and greater than 30°F, a defrost timing cycle will begin. The defrost timing cycle will allow operation of the heat pump for 25 minutes. The fan will then be shut off, the refrigerant flow reversed and run for 4 ½ minutes, this is the DEFROST cycle. The refrigerant flow will then be returned to normal and, after a 30 second delay will continue until the temperature is greater than 42°F or until the temperature becomes less than 30°F, at which time the furnace will activate. (See AUX. HEAT section). During the defrost cycle, the DEFROST indicator on the LCD shall be illuminated.

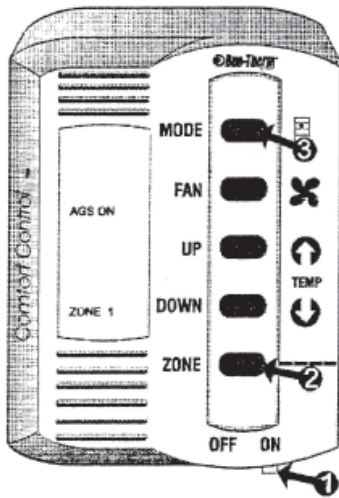

### G. OPTIONAL AUTOMATIC GENERATOR START (AGS)

On coaches equipped with an optional AGS kit the coach generator will automatically start when any zone calls for cooling and will shut off when all zones reach set point.

1. Put the power switch in the ON position.
2. Momentarily depress and release the ZONE push-button until AGS indicator appears on the LCD.
3. Momentarily depress and release the MODE push-button to select AGS status.

**IMPORTANT: When shore power is available, AGS must be switched to the off position.**

### 4-9.3.3 General Information

The ability of the air conditioner to maintain the desired inside temperature depends on the heat gain of the coach. Some preventative measures taken by the occupants of the coach can reduce the heat gain and improve the performance of the air conditioner. During extremely high outdoor temperatures, the heat gain of the vehicle may be reduced by:

1. Parking the coach in a shaded area.
2. Using window shades (blinds and/or curtains).
3. Keeping windows and doors shut or minimizing usage.
4. Avoiding the use of heat producing appliances.

Starting the air conditioner early in the morning and giving it a “head start” on the expected high outdoor ambient temperature will greatly improve its ability to maintain the desired indoor temperature.

The manufacturer of this air conditioner will not be responsible for damage caused by condensed moisture on ceilings or other surfaces. Air contains moisture and this moisture tends to condense on cold surfaces. When air enters the coach, condensed moisture may appear on the ceiling windows, metal parts, etc. The air conditioner removes this moisture from the air during normal operation. Keeping doors and windows closed when this air conditioner is in operation will minimize condensed moisture on cold surfaces.

This equipment must be serviced by qualified personnel and some states require these people to be licensed.

### 4-9.3.4 Rebooting

Just like your computer which you may have to reboot from time to time to correct erratic behavior, you also may need to reboot the Comfort Control panel. Voltage spikes may get it off message Resetting takes it back to the factory settings.

1. Turn slide switch to OFF position
2. Press and hold down MODE and ZONE buttons
3. Turn slide switch to ON position
4. Release MODE and ZONE buttons
5. FF appears in display, indicating reset is complete

### 4-9.3.5 Maintenance

**AIR FILTER:** Periodically remove the return air filter. Wash the filter with soap and warm water; let dry and then reinstall or replace as required.

**NOTE:** Never run the air conditioner without the return air filter in place. This may plug the unit evaporator coil with dirt and may substantially affect the performance of the unit.

**Comfort Control Center™:** clean the Comfort Control Center™ with a moist, soft cloth. DO NOT use solvents for cleaning.

### 4-9.3.6 Service

If your unit fails to operate or operates improperly, check the following before calling your service center.

- a. If your coach is connected to a motor generator, check to be sure the motor generator is running and producing power.
- b. If the coach is connected to a power supply by a land line, check to be sure the line is sized properly to run air conditioner load and it is plugged into the power supply.
- c. Check the 115VAC fuse or circuit breaker to see if it is open.
- d. Check the 12VDC fuse or circuit breaker to see if it is open.
- e. After the above checks, call your local service center for further help. This unit must be serviced by qualified service personnel only.

When calling for service, always give the following:

1. Air Conditioner Model Number and Serial Number found on Rating Plate located on the Base Pan of the air conditioner.
2. Electronic Control Kit Part Number and Serial Number found on Rating Plate located on the side of the kit.

**RETURN AIR GRILL MUST BE REMOVED FROM THE RETURN AIR COVER TO VIEW THESE RATING PLATES**

## 4-9.4 Automotive Air and Heat System

The dash heat and air system are a separate HVAC system designed to meet the latest refrigerant requirements. This unit provides the ability to mix heat and air to provide defrosting capability.

## 4-10 Fresh Water System

### 4-10.1 Water Supply and Distribution System

The fresh water tank is approximately 100 gallons. The dual purpose Tank Water Fill/Municipal Water inlet connection is located in the road side holding tank compartment, in Bay 4, left. The Tank Fill On-Off switch, located in Bay 4, left, diverts the municipal water input to fill the pure water storage tank, which is also located in Bay 4. System water pressure is provided by a water pump located in the roadside compartment, Bay 3, left. The fresh water tank is non-pressurized with the system water pressure developed by a demand pump when not connected to a municipal water system. The fresh water tank is equipped with a two inch drain. The tank also includes level indicators, located on the curbside end of the fresh water tank. All of the water supplied to the motor home is filtered through an activated carbon filter.



### 4-10.2 Municipal Water Hookup

When facilities are available, the Municipal Water hookup can be used to supply all motor home water system requirements. In this manner, the fresh water tank and pump system are automatically bypassed with the water pressure regulated by the municipal water system (approximately 40 psi).

### 4-10.3 Filling and Draining

To fill the fresh water tank, connect the water hose to the municipal water inlet, set the Tank Fill switch to ON, then turn on the water supply. When the tank is full, the level switch in the tank will close the tank fill solenoid. Set the Tank Fill switch to the OFF position, shut off the water supply and disconnect the hose. At this time, check that the Monitor panel readout indicates a full water tank. By pressing the Pure tank switch and observing that all, E through F indicator segments are lit.

**NOTE:** The Tank Fill switch should be ON only when the water tank is being filled. This switch must be in the OFF position at all other times.

#### 4-10.3.1 Sanitizing

Water system sanitizing procedures should be followed before the system is used for the first time, after long idle periods where water may become stagnant, or after any suspected contamination of the water supply. Whenever possible, use a commercially approved tank sanitizer and follow the procedures on the product package. If it is not possible to use a commercial product, prepare your own mixture and sanitize the tank in accordance with the following procedures:

1. **Empty the Fresh Water Tanks** – To drain the tanks, open the 2-inch Cold Water Drain Valve located inside the opening below the fresh water tank on the roadside, Bay 4, left. Pull valve toward front of motor home. After the tank is completely drained, close the Cold Water Drain.
2. **Prepare the Sanitizing Solution** – Each gallon of Sanitizing solution consists of ¼ cup of household bleach (sodium hypochlorite) solution and one gallon of water. This mixture results in a residual chlorine concentration of 50 ppm in the water system. Seven to eight gallons of sanitizing solution will be adequate for the fresh water tank. (Approximately 100 gallons).
3. **Add sanitizing solution to water tank** – Remove deck lid plug in the curbside close out panel. Remove 3/4 inch plug from the side of the tank in the curb side luggage compartment and pour the solution into the tank. Reinstall the plug in the tank.
4. **Fill tank to capacity** – Connect the hose to the municipal water inlet, turn on the Tank Fill Switch and fill the water tanks completely. Shut off the hose and turn off the Tank Fill switch. Turn on the water pumps. Open each faucet (hot and cold), and run the water until a distinct odor of chlorine can be detected. Shut off the water pump.
5. **Allow the system to stand** – Let stand for at least 4 hours when disinfecting with 50 ppm residual chlorine. If a shorter time period is desired, then a 100 ppm chlorine concentration should be permitted to stand in the system for at least one hour.

6. **Drain tanks** – Open the Cold Water Drain valve (as in Step 1), and allow the tank to drain completely.
7. **Refill tanks** – Close the Cold Water Drain valve and turn on the water supply to the municipal water inlet. Turn on the Tank Fill switch and fill the tank completely. When the tank is full, turn off the Tank Fill switch, shut off the water supply and disconnect the hose. Then replace the fill cap and turn on the water pump. When water flows from the opened faucets, close them and open the other faucets until water flows. This flushes the system, removing trapped air from piping and ensures that the fresh water supply is ready for use.

**CAUTION!!** Do not permit sanitizing or antifreeze solutions to enter water filter.

8. Repeat steps 6 and 7 until the chlorine smell and taste is no longer present at the faucets.

### 4-10.3.2 Water Filter Replacement

Depending upon the condition of the municipal water used, the filter media will degrade with use. The only practical way to determine when replacement is required is to go by the sense of taste. It is recommended that the filter be changed after prolonged storage.

### 4-10.3.3 Water Heater

With the Webasto system at operating temperature, the domestic water is automatically heated as it is being used. Open any hot water faucet and a continuous supply of domestic hot water will be present within a few seconds. This is accomplished by the Webasto's domestic hot water zones, which are an integral part of the heating system. A mixer valve has been installed to ensure that excessively hot water does not flow to the faucets.

**CAUTION!!** The mixer valve is not an anti-scald device. Always exercise reasonable caution when using hot water.

**CAUTION!!** Do not turn the Webasto's unit off if the outside temperature is 32 °F or lower when the potable water system is not drained.

### 4-10.3.4 Water Pump

The water pump is located in the road side luggage compartment (bay 3). The pump employs state-of-the-art electronics to automatically control motor speed. The pump adjusts its speed as you open and close water fixtures. If the pump has been out of service for a period of time, it is advisable to open a faucet before turning them on. When water flows steadily from the opened faucet, close the faucet and observe that the pump shuts off when the system becomes pressurized. (It may also be necessary to bleed the air from the other faucets as well.) When the fresh water supply tank level is low or empty, shut the pump off to prevent possible damage to the pump motor. In addition to integral motor overload protection; the pump mechanism is also protected from damage by the presence of a filter at the water pump inlet. The filter should be cleaned periodically.

Under normal usage, the water pump should require no periodic maintenance other than ensuring that the input water supply is properly filtered of particles that could damage the pump mechanism. Pump failures can generally be tied to the plumbing system or to electrical wiring. If a pump fails to operate properly, refer to the general troubleshooting guide.



**Note that detailed pump repairs and overhaul should be performed by a qualified repair facility.**

### 4-10.3.5 Water Pump Switch

The central control switch, labeled water pump, for the water pump is in the bathroom.

The associated indicator is lit whenever power is being supplied to the pump. Turning ON the switch pressurizes the water system, with the pump maintaining constant pressure. Continuous or erratic pump operation can indicate an empty water tank, system leakage or air lock in the water lines. Switches enabling the water pump are located in the bathroom, in the kitchen and in the roadside holding tank bay. These switches are labeled water pump.

### 4-10.3.6 Manifold

All cold and hot water is directed to the distribution manifold. Hot and cold water is distributed to each fixture via individual 3/8" I.D. lines. Individual shut-off valves are located on the manifold, and are used to shut off water to respective fixtures in the motor home. A 1/8" I.D. line is used for the refrigerator ice maker.

### 4-10.3.7 Water Pump Troubleshooting Guide

Symptom	Possible Cause	Corrective Action
<b>Pump operates but no water flows through the faucet.</b>	Low water level in the tank.	Add water.
	Suction lines or filters clogged.	Clear water lines and clean filters.
	Kink in the water suction hose.	Check water hose connections to tank and straighten or replace as necessary.
	Air leak in suction line.	Replace suction line.
	Defective water pump.	Rebuild or replace pump.
<b>Pump cycles on and off when faucets are closed.</b>	Water leak in plumbing.	Check for signs of leakage and tighten or replace fittings, pipe, etc.
	Defective toilet flush valve.	Repair flush valve.
	Defective water pump.	Rebuild or replace pump.
<b>Pump operates roughly and has excessive noise and vibration.</b>	Intake line is restricted, kink in suction hose or fittings are too small.	Check input hoses and straighten or replace, as necessary.
	Defective water pump.	Rebuild or replace pump.
<b>Pump fails to start when faucet is opened:</b>	Clogged pressure piping.	Blow out water lines with compressed air. Maximum pressure that can be used is 40 psi.
	No voltage to pump.	Check input wiring circuit breaker and switches.
	Defective water pump.	Rebuild or replace pump.
<b>Pump gives low water pressure and flow;</b>	Defective water pump.	Replace diaphragm or motor.
	Tank fill switch left on.	Turn off tank fill switch.

 **NOTE: Before blowing out water lines, be sure to remove both lines from pump to avoid blowing out towards pump. Procedure may be best performed by a certified technician.**

## 4-10-4 Winterizing

If you are planning on storing your motor home in an unheated area during cold weather, it is necessary to winterize the water system to prevent damage from freezing conditions. Winterizing procedures are covered in the following paragraphs.

### 4-10.4.1 Draining and Winterizing the Fresh Water Supply System

The following procedures show the use of the various drain valves and controls to winterize the fresh water system.

1. Open the main circuit breaker box (located in bedroom) and turn off the Water Heater and Instant Hot circuit breakers.
2. Turn on Water Pump switch (located in bathroom) and open all faucets (galley sink, lavatory, shower, outside hose connection and toilet water valve – after depressing pedal insert block to maintain position). Note that the outside water faucet should always be left open when freezing temperatures are expected. Also, remove drain plugs at rear of toilet and at bottom of Instant Hot. Refer to the Icemaker and Toilet Sections for winterizing these units.)
3. Open the Cold and Hot Water Drain valves located in roadside Bay 4, luggage compartment. Open 2" water tank drain valve in road side first luggage compartment, Bay 4.
4. Allow water to drain completely before proceeding to the next step.

5. Turn off water pump switch.
6. Unroll coiled hose under road side end of fresh water tank. Hose is connected to valve assembly under tank (Bay 4).
7. Feed open end of hose into container of RV antifreeze. Approximately 3 to 5 gallons required.
8. Close the valve on the suction line coming from the fresh water tank and open the valve from the RV antifreeze line.
9. Close all fresh water manifold valves. Except the top hot water valve.
10. Turn on fresh water pump. Make sure RV antifreeze is moving into pump and into the manifold. Be ready to close the cold water drain valve, under manifold exiting the floor, when antifreeze exits the line under motor home. Also close hot water drain at this time.
11. Continue to run pump to fill the water heater and the hot water side of the manifold until antifreeze exits the hot water valve left open in step 9.
12. Open the hot water drain valve, closed in step 10, and close it again when antifreeze exits the hot water drain line.
13. Turn pump off at this time and close the valve on the antifreeze line. Stow hose in original location.
14. Make sure all the interior and exterior faucets, as well as, the ice maker, toilet and clothes washer are open.
15. At this point, the only water remaining in the system is contained in the P traps beneath the lavatory sink, shower drain, and kitchen sink (clothes washer optional). To prevent this water from freezing and damaging traps, put one pint of RV system anti-freeze into each drain. See [WASTE SYSTEM WINTERIZING](#).



**NOTE: When reactivating the system, make sure (optional) Instant Hot is full of water before switching on.**



## 4-11 Waste System

### 4-11.1 Air Flow Toilet

The waste system supplied in this vehicle is a Microphor Air Flow Toilet. The following information will discuss how these systems operate, how to take care of them, plus useful tips about the system itself.

#### 4-11.1.1 How Microflush Toilets Operate

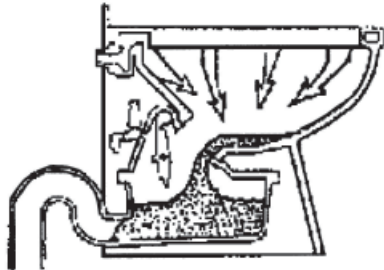

When the flush handle is pressed the flapper opens, allowing wastewater to flow into the hopper. Clean water enters the bowl from the rim to thoroughly wash the bowl.

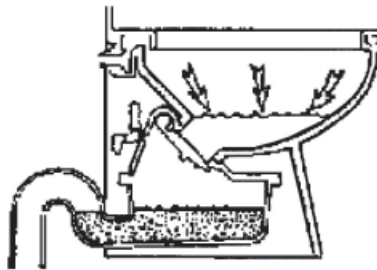

After 4-8 seconds, the flapper closes. Clean water continues to flow into the bowl, where it remains until the next flush.

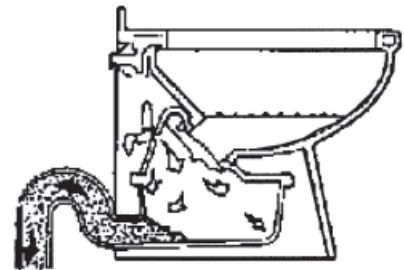

When the flapper has closed, compressed air enters the hopper, pushing the waste over the trap and into the waste line.

#### 4-11.1.2 Air/Water Sequence Valve Operation

1. In the normal rest position, pressurized air enters the Flush Activator and goes from Flush Activator Port 1 (green tube) to Air/Water Sequence Valve Port 2, through Port 3 (red tube) to Air Cylinder Port 4 holding the Flapper closed, sealing the water in the bowl and maintaining a proper water surface area.
2. When the Flush Activator is pressed, air is shifted to Port 5 (blue tube) to A/W-Seq. Valve Port 6 and on to Air Cylinder Port 8 (white tube). The air in the base of the Air Cylinder is bled off through Port 4 (red tube) to Port 3 and out Vent [1], allowing the Air Cylinder to retract, opening the Flapper. Simultaneously, pressurized air in the base of the A/W Seq. valve pushes the piston and spool assembly up to open the water passage, allowing water to enter and rinse the bowl. The air on the top of the piston is bled off through Port 1 and out Vent [2].

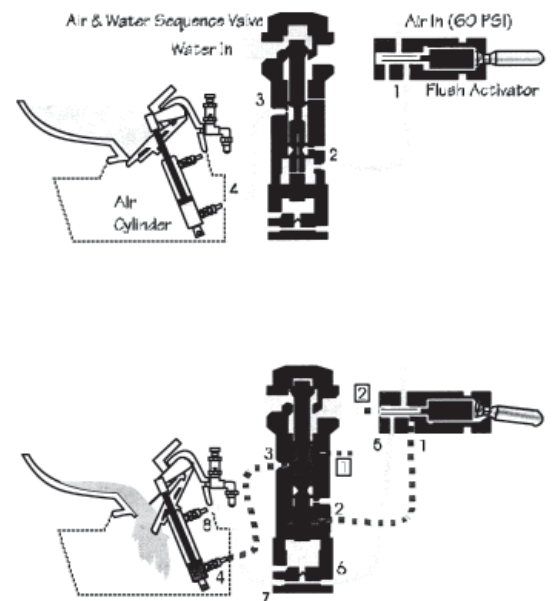

- As the Flush Lever is released, the Flush Activator returns to the normal rest position redirecting pressurized air to Port 2, Port 3 and Port 4. The Bleed-Off Plug [12] bleeds off the air (black tube) under the piston, causing the spool to move downward, gradually closing the water passageway. The air having been bled off the top of the Air Cylinder Port 8 (white tube) through the end of the Flush Activator Vent [2] (blue tube), allows the Air Cylinder to close the Flapper allowing water to accumulate in the bowl, restoring a proper water surface area.
- Near the bottom of the piston stroke, the air passageway from Port 10 (yellow tube) to the Hopper Port 11 is unblocked for 4-11 seconds to pressurize the hopper and expel the waste contents over the trap and into the waste line.
- As the A/W Seq. Spool reaches the bottom position, the water supply is shut off, completing the flush cycle.

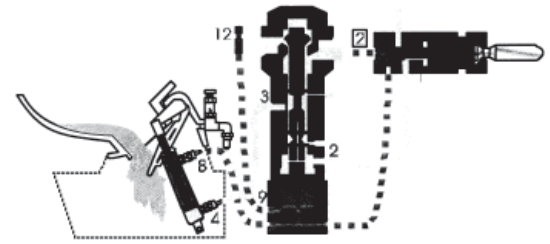

In the event of air supply failure, the spring in the Air/Water Sequence Valve maintains the valve in the closed position, blocking the water passageway. The flapper will open and allow water in the bowl to flow into the hopper forming a water seal.

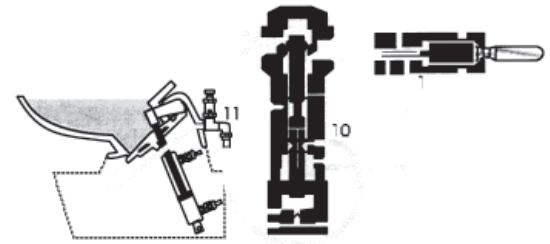

### 4-11.1.2 Cleaning

Use Micro-Clean Organic Spray Cleaner, P/N 24542, or equivalent cleaner approved by Microphor designed for Microflush toilets. Caustic drain openers or non-biodegradable cleaners should not be used.

- While depressing the flush activator, turn OFF the water. Allow the bowl cleaner to flow into the lower chamber. Keep the flush deactivator pressed.
- Insert bowl brush into lower chamber and agitate mixture.
- Remove the bowl brush and release the flush activator.
- Turn the water ON and flush twice to rinse thoroughly. If using a cleaner other than one with a Microphor Biological Waste Treatment System, check with your Coachworks Service Department or with Microphor for acceptable cleaners. You can access Microphor's website by <http://www.microphor.com>

### 4-11.1.3 Clearing Plugged Toilet

Turn water OFF, press flush handle and hold to remove water from the bowl. The flapper in the bottom of the toilet will remain open until the flush handle is released. Check to see if the restriction can be removed from the hopper with a hooked wire, being careful not to damage the rubber seal on the flapper or the mating surface on the hopper. If obstruction cannot be picked out with a hook or tongs, use a plunger by pushing in slowly and pulling out quickly to pull object back into the hopper. If necessary, turn the air OFF and use a snake inserted through a 12" plastic pipe placed in hopper. The pipe will protect the flapper seal from damage. If the Air/Water Sequence Valve will not operate with the water turned OFF, hold the flush lever down and turn the water ON and OFF quickly to free the valve action. When the passage becomes clear, turn the water ON and press the flush handle to start the flush cycle.

### 4-11.1.4 Winterizing

Shut OFF water to toilet. Flush toilet three times or until water no longer flows into the bowl. Unhook water supply at angle stop. Empty water in line into receptacle. Shut OFF air supply to the toilet. The unit is now prepared for freezing temperatures. Open petcocks on drip legs and air receiver drain after shutting down air compressor and isolating air lines.

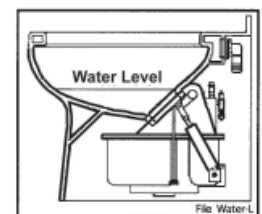

### 4-11.1.5 Cleaning Bleed Off Assembly

**Standard Flush** – Remove plug and clean with solvent; air blow dry.

**Positive Flush** – Remove plug and clean with solvent; air blow dry, remove and clean plug on Detent Valve.

**NOTE:** Use 5/32" (4mm) Allen wrench to remove plugs.

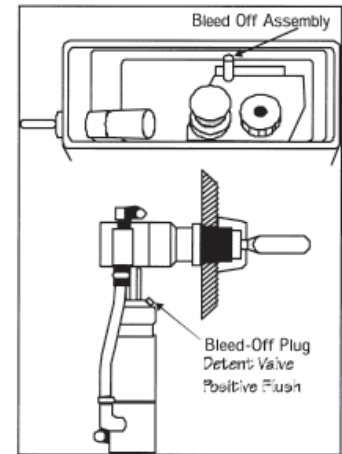

### 4-11.1.6 Air System Design

Filter-regulators are available in a variety of sizes and types. Their purpose is to remove water and foreign matter from the air line and to maintain a constant pressure of 60-65 psi to the toilet. The following steps must be observed to assure moisture will be removed from the air line.

1. Drain air compressor receiver regularly. Most water tends to accumulate at this point.
2. Install drip legs with condensate drains at all low points in air piping.
3. Whenever possible, grade all air lines back to the air receiver or drip leg assembly and drain regularly.
4. The air supply to the toilet must be taken from the top of the main or branch air line.

### 4-11.1.7 Troubleshooting

Your Microflush® toilet is designed to give you years of trouble-free operation. Please check the following before beginning any service or repair.

- Water supply:**
1. Is the water turned on?
  2. Is the water pressure between 20 and 50 psi at the toilet for pressure water system?
  3. Is there 6 feet minimum of head for gravity systems?

Fluctuating or high water pressure can cause intermittent problems with the toilet operation. Check the water pressure at different times of the day (i.e., early morning, noon, evening) to determine if you have fluctuating or high water pressure. A pressure-reducing valve installed on the incoming water line will assure you have even pressure. Make sure no check valve is installed before the Air/Water Sequence Valve.

- Air system:**
1. Is the air turned on?
  2. Is the air pressure set at a constant 60-65 psi at the toilet?
  3. Do you have any air leaks or kinks in the air system?
  4. Do you have water in the air system? This usually causes irregular timing.

Drain the compressor tank and check the filter regulator and drip leg(s) for water. To check for water in Air/Water Seq. Valve, remove Bleed-Off Plug, put finger over screw opening and flush. If water is present, it will squirt out. If water is detected, then the air cylinder and airlines must also be drained.

- Cycle time:**
1. Is the flapper cycle time set correctly at 4-8 seconds?
  2. Is the bleed off assembly plug blocked? Remove, clean and reinstall.

Trouble	Possible Causes	Correction
Flapper does not open. Water does not flow. Nothing happens.	1. No air supply to Microflush. 2. Water has accumulated in Air/Water Sequence Valve	1. Supply compressed air at 60-65 psi. 2. <a href="#">See Check Air System.</a>
Flapper opens and closes 4-7 seconds after handle is released, but no water enters bowl.	1. No water supply to Microflush. 2. Water turned off.	1. Supply water at 20-50 psi. 2. Open angle stop (shut-off valve).
Flapper opens when flushed, and closes immediately when activator is released.	1. Excessively high water pressure.	1. Install water pressure regulating valve, set at 20-50 psi.
	2. Debris in check valve at base of Air/Water Sequence Valve.	2. Clean Air/Water Seq. Valve.
Flapper opens and will not close.	Bleed-Off plug blocked.	Remove, clean or replace, reinstall.
Water continues to run when Microflush is not in use.	Foreign object is under water valve in Air/Water Sequence Valve.	Clean Air/Water Sequence Valve. Reference Service Kit P/N 95057.
Water splashes when flushed.	Water is too high in bowl.	Reduce incoming water via angle stop.
Flush cycle is too long.	Bleed-Off plug blocked.	Remove, clean or replace, reinstall.
Flush cycle is too short.	Bleed-Off plug hole too large or related air lines leaking.	Remove, replace, and check for air line leaks.

If other problems are encountered, please contact the factory: Toll Free 1-800-358-8280

### 4-11.1.8 Basic Repair Procedures

#### Hopper Components

A	00064	SS Mounting Screws (14 each)
B	27207	Gasket, flapper
C	27272	O-Ring Seal, Hopper Top to Bottom
D	37518	Pressure Relief Valve
E	37548	Bleed Valve
F	90042	Crank Arm Assy.
G	90048	Flapper Assy.
H	9001 2-3	Hopper Top with Crank and Flapper Assy.
I	45060	Hopper Bottom Assy. (not including P-trap)
J	96029	P-Trap Assy., Rear Discharge
K	95157	P-Trap Assy., Downward Discharge
	20137	Valve Mounting Bracket
	48718	Conduit Clamp
	10194	Retaining Ring, Air Cylinder

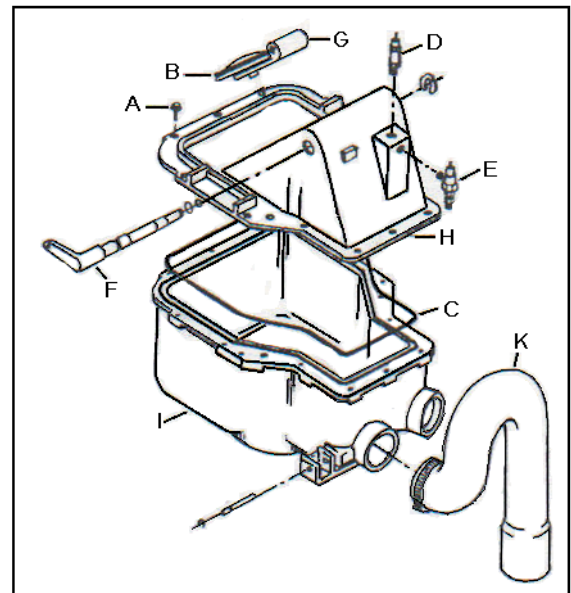

### 4-11.1.9 Hopper Replacement

**CAUTION!!** Read this entire procedure before beginning work!

1. Remove toilet from floor. Place toilet upside down on a sheet of cardboard or other padded material.
2. Remove nuts from hopper supports on either side of hopper, lift hopper from bowl.
3. Remove o-ring between hopper and seal adapter. Check that o-ring is not damaged, replace if necessary.
4. Re-assemble in reverse order.  
*Make sure J-bolts are tight, and pulled tight to china hopper mounting flange!*

**NOTE:** The air cylinder on the hopper sub-assembly should be cleaned, lubricated and checked for adjustment whenever the toilet assembly is removed for servicing.

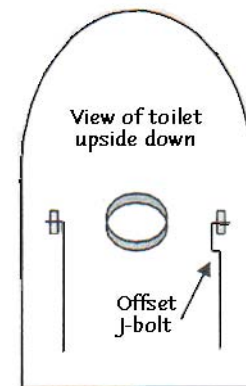
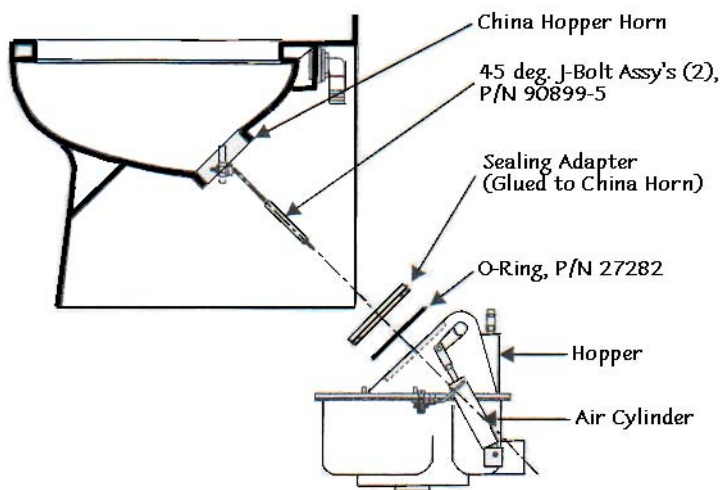
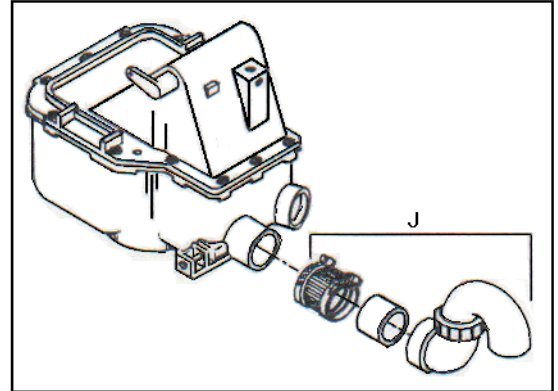

### 4-11.1.10 To Change Flapper Gasket:

1. Turn water and air off.
2. Reach behind flapper to grasp gasket tails.
3. Pull tails out of slots to remove old gasket.
4. Installation is the reverse of removal.
5. Tails must be pulled all the way through to insure smooth surface.

### 4-11.1.11 Air Cylinder Adjustment

1. Remove toilet from floor.
2. At hopper, remove upper and lower retaining rings and clevis pin.
3. Inspect the crank arm, clevis and clevis pin for wear. Replace if required.
4. Fully extend the air cylinder – it should measure 7-1/4" between the centers of two mounting holes.

Adjust as necessary:

- A. Fully extend the Air Cylinder.
- B. Protect the shaft with thick cloth or rubber and hold firmly with pliers.
- C. Place a screwdriver through the clevis mounting hole and turn: clockwise to shorten length; counterclockwise to extend length.

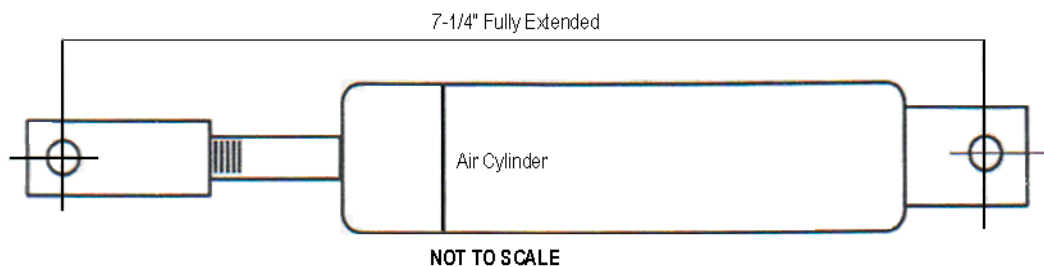
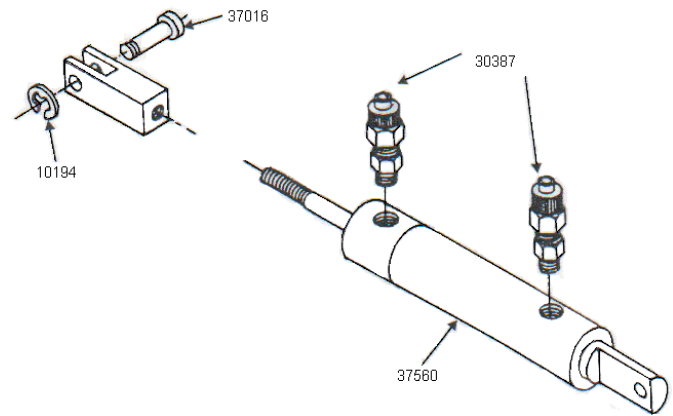

### 4-11.1.12 Customer Service

If you have any questions concerning your Microphor product, please contact us:

8:00 a.m.-5:00 p.m. PST Monday-Friday

Tel: (800) 358-8280 or (707) 459-5563

Fax: (707) 459-6617 24 hours

Website: [www.microphor.com](http://www.microphor.com)

**IMPORTANT NOTE: Only do service procedures yourself if you have the knowledge and experience to do so. If unsure, contact a Coachworks service center or a qualified professional to have the procedure performed.**

### 4-11.1.13 Cautions

Refer to the following table for cautions that need to be adhered to concerning the toilet.

Water Pressure	Must be regulated at an even pressure between 20 to 50 PSI at the toilet.
Air Pressure	Must be regulated at 60-65 PSI constant at the toilet.
Pipe Sealant	Use plastic compatible teflon based pipe sealants.
<b>Do Not Use</b>	Any "Loctite" brand adhesive on any plastic or Delrin components, as fumes will cause damage to plastic parts.
<b>Do Not Use</b>	Products containing petroleum distillates or formaldehyde on any rubber parts. Use Only Silicone Lubricants!
<b>Do Not Use</b>	Teflon tape on any air fittings as clogging may occur.

## 4-12 LPG System

This vehicle is equipped with a permanently mounted, 30 gallon (102 pounds of fuel-net) LP gas tank, which is the energy source for the cooktop (range) and an alternative source for the refrigerator.

### 4-12.1 LPG Tank and Controls

The LPG supply tank is located in an unlocked compartment behind the rear axle on the passenger side of the motor home. LPG system controls include a main gas service valve, solenoid shut-off valve, two stage pressure regulator, filler connection with Auto Stop (80%) fill valve, 20% vapor (stop filling when liquid appears) valve, and the pressure relief valve.

#### WARNING!!

**When the motor home is to be stored in a confined area, turn off the LPG at the main tank shutoff valve. With the LPG leak detector, this may now be accomplished by turning off the LPG Master Switch on the galley panel.**

LPG tank level can be monitored at the tank monitor panel located in the pantry.

#### 4-12.1.1 Fuel Requirements

Liquefied petroleum gas is a material composed of various hydrocarbons such as propane, butane, or a mixture thereof. In its gaseous form (vaporized), it is colorless and has a garlic-scented additive to ensure detection. In addition to being highly flammable, it is also dangerous to inhale. For ease of transportation and storage, LPG is compressed into a liquid state and stored in this form within the LPG tank. As fuel is used, vapor passes from the top of the tank into the two-stage pressure regulator and to the various gas appliances.

Appliances do not function if the LP gas does not vaporize. Butane does not vaporize below 32 degrees Fahrenheit (the freezing point of water), but propane continues to vaporize down to 44 degrees below zero. Propane has become the main type of LP gas used in RVs in recent years. Your LP supplier has the correct type or blend for your locale. If your travels take you into an area where climate differs, ask your LP dealer for his recommendations. The names of LP suppliers can be found in the yellow pages of the telephone directory under "Gas-Liquefied Petroleum-Bottled & Bulk." Many campgrounds now have LP gas fill facilities, as do some service stations.

Prevent condensation and possible regulator or line freeze-ups when filling the tank by requesting the dealer to add a small amount of methyl alcohol to the fill up. A common mixture is one ounce of methyl alcohol to each 20 pounds of LPG.



**NOTE: Liquefied petroleum gas is heavier than air.**

### 4-12.2 Filling the LP Gas Tank

When the tank is being filled, the service valve must be closed and the 80% liquid level valve (20% vapor valve) must be open. The 80% auto stop fill valve may close before liquid appears at the 80% liquid level valve, but if liquid does appear, stop filling immediately; the tank is filled to its LP capacity. Close the liquid level valve. Do not use a wrench to tighten this valve or the service valve; they are designed to be closed leak-tight by hand. If you cannot hand-tighten properly, the valve probably needs repair or replacement.

#### CAUTION!!

Be sure that the main LPG supply is shut off during refueling to prevent accidental ignition of gas fumes by appliance igniters.

#### CAUTION!!

All gas appliances must be cut off before filling the LPG tank. Check gas lines and fittings periodically for tightness and leakage.

### 4-12.2.1 Regulator

The two-stage pressure regulator regulates the pressure of the LPG supplied to the appliances. The regulator functions automatically and is factory-preset to provide the correct line pressure. Do not attempt to tamper with or reset the regulator! Even a small variation above the normal gas line pressure can be sufficient to create a dangerous situation and cause possible damage to individual appliance components. If there is any doubt about the regulator setting, it can be checked by your Coachworks Service Department or LPG supplier. The correct setting is 11-14 inch water column.

### 4-12.2.2 Operation

To operate any LPG appliance, the main gas (Service) valve must be open. In addition, individual valves at each appliance must be opened prior to use. When first used, or after a refill, there may be some air in the gas lines, which escapes, when you open a range burner or similar LP gas valve. The air may extinguish your match or igniter the first time or two before you get ignition. Remember, too, that when you close the tank's service valve some of the gas will remain in the lines. To completely bleed the lines of gas, close the tank's service valve and light a range burner to use up the excess. When the flame burns out, turn the range burner off.

## 4-12.3 Checking for Leaks

Periodically check the LP system for possible leakage. Do not wait for an alarm condition to occur before correcting a leak! Although the entire system and associated appliances undergo extensive factory testing for leakage, road shocks and heavy vibrations may loosen or damage piping or fittings. Leaks will usually become noticeable by the characteristic odor of the garlic-scented gas additive. To check, turn off all burners and pilot lights. Open all doors and windows. Open LPG tank service valve and use an ammonia and chlorine free soap-bubble solution on all connections. Any bubbles are evidence of leakage.

NOTE: The gas leakage detectors may momentarily sound an alarm when the engine is initially started or when a heavy electrical load is placed on the system. Further, the ultra sensitive response of these units may also cause an alarm to be given in the presence of certain pressurized-can sprays or cleaning agents. Do not assume! Always determine the reason for this vital alarm being given!

## 4-12.4 LPG Consumption

Most gas appliances are intermittently operated; however, operation during cold weather conditions does cause heavy consumption. The amount of LPG consumption depends on the total use and the manner in which these appliances are used. For your guidance in estimating your anticipated fuel consumption, the following is a listing of typical appliance consumption ratings when the appliance is operated for one hour:

Refrigerator: 1,500 BTUs

Cooktop Burners 5,200 BTUs each

## 4-12.5 LPG System Warnings

 Note that each gallon (4 1/4 lb.) of LPG fuel produces approximately 91,500 BTUs of heat energy. The LPG tank used in your motor home will furnish over 2.1 million BTUs.

### WARNING!!

LP gas containers are not be placed or stored inside the vehicle. LP gas containers are equipped with safety devices, which relieve excessive pressure by discharging gas to the atmosphere.

 NOTE: The compartment the LPG tank is located in is NOT intended for storage – Do not place any items on, under or around the LPG tank.

### WARNING!!

It is not safe to use cooking appliances for comfort heat.



A warning label has been placed in the cooking area to remind you to provide an adequate supply of fresh air for combustion. Unlike homes, the amount of oxygen supply is limited due to the size of the recreational vehicle, and proper ventilation when using the cooking appliance(s) will avoid dangers of asphyxiation. It is especially important that cooking appliances not be used for comfort heating as the danger of asphyxiation is greater when the appliance is used for long periods of time.

Cooking appliances need fresh air for safe operation. Before operation:

1. Open overhead vent or turn on exhaust fan.
2. Open window.

A warning label has been located near the LP gas container. This label reads:

**WARNING!!** Do not fill container(s) to more than 80 percent of capacity.

Overfilling the LP gas container can result in uncontrolled gas flow, which can cause fire or explosion. A properly filled container will contain approximately 80 percent of its volume as liquid LP gas.

**WARNING!!** Portable fuel-burning equipment, including wood and charcoal grills and stoves, are not to be used inside the motorhome. The use of this equipment inside the motorhome may cause fires or asphyxiation.

**WARNING!!** Do not bring or store LP gas containers, gasoline or other flammable liquids inside the vehicle because a fire or explosion may result.

The following label has been placed in the vehicle near the range area:

IF YOU SMELL GAS

1. Extinguish any open flames, pilot lights and all smoking materials.
2. Do not touch electrical switches.
3. Shut off the gas supply at the tank valve(s) or gas supply connection.
4. Open doors and other ventilated openings.
5. Leave the area until odor clears.
6. Have the gas system checked and leakage source corrected before using again.

LP gas regulators must always be installed with the diaphragm vent facing downward. This minimizes any chances of vent blockage, which could result in excessive gas pressure causing fire or explosion.

**WARNING!!** Never check for leaks with an open flame. Do not check copper plumbing lines for leaks using ammoniated or chlorinated household-type detergents. These can cause cracks to form on the line and brass fittings. If the leak cannot be located, take the unit to your Coachworks Service Department or LPG supplier.

## 4-12.6 LPG Leak Detector System

The system has been developed to the point where it is unique; it shuts off the LP gas at the high-pressure source, yet holds the valve open to provide ample appliance flow with a minimum amount of current usage.

Three components make up the system:

- 1. Gas Detection Control Unit:** mounted in toe kick of the kitchen base cabinet. This is the “brains” of the system and provides an electrical signal to the solenoid valve when LPG service is required.
- 2. Solenoid Valve:** installed in the high pressure LPG line feeding the two-stage regulator. It is a “normally closed” solenoid valve and has a special winding of 22 ohms (approximate) resistance, so it uses very little current in the “hold open” position. In order to close the valve, it is only necessary to break the circuit. This provides a “fail-safe” feature in the event of loss of 12-volt power.
- 3. LPG Master switch:** located on the galley panel.

The following events will result in an open/low voltage circuit and allow the solenoid valve to close and shut off the LPG supply:

1. Pushing the switch to “OFF” on the LPG MASTER switch or the Gas Detection Control Unit. Green light will go out.
2. The Gas Detection Control Unit senses the presence of LP gas (or can be triggered by a propane lighter or even hair spray!). Green light goes out, Red light comes on, along with audible signal.
3. The Electronic Master switch is turned off. Green light will go out.



**NOTE: System is not Master Switch Activated.**

1. Push switch on the LPG MASTER and the Gas Detection Control Unit to “ON.” Green light will come on.
2. Correct the cause of LP gas leak or determine if other fumes caused the shut down. Green light will come on.
3. Turn Electronic Master Switch on. Green light will come on.



**NOTE: Because of the presence of an excess flow valve in the LPG tank outlet (safety feature); sometimes an appliance may not relight after a shutdown. In this circumstance, wait five (5) minutes for LPG pressures to equalize before relighting.**

## 4-13 Air Pressure System

### 4-13.1 Description and Operation

An engine-driven compressor supplies the air pressure system on your coach. It provides pneumatic power for brakes, suspension, and numerous accessories. This complex, but efficient system is not intended to be totally leak free. After overnight parking, you may notice a significant loss of pressure on the air pressure front/rear gauge, or in systems connected to auxiliary air. This condition is normal, and in fact, our air leakage tolerance is tighter than most manufacturers within the heavy-duty equipment industry. Once the engine is running, the engine-driven compressor will quickly build up the system to the correct pressure.

#### 4-13.1.1 Air Brakes

Your coach is equipped with dual service air brake systems for front and rear, with integral fail/safe operation; and manual/automatic rear spring (parking) brakes. The service brakes are completely independent systems, each including a reservoir and separate distribution lines and valves. The reservoirs are pressurized from a single compressor. Both service brake systems are brought into operation each time the brake treadle is depressed to slow or stop the coach. Reservoir pressure for each service brake system is monitored by a respective pressure gauge on the front panel; system failure(s) are indicated by low-pressure readings, illumination of the Low Air failure lamp and sounding of a buzzer.

#### 4-13.1.2 Operation

When the coach is parked, and the engine is off, the rear spring brake will normally be set by operating the parking brake. The spring brakes cannot be fully released until the air pressure is above 65 psi. These brakes are in the released position when the control is pushed in. In the event that there is a loss of air pressure, the spring brakes will set automatically at the brake-applied position, and will not release until the air reserve has again built up to required value. Consequently, there will be a normal delay, after the coach is first started, while the compressor builds up pressure before the brakes can be released and the coach driven. When the brake treadle is depressed to slow or stop the coach, reservoir air is applied simultaneously to both front and rear service brakes to effect the braking action. The spring brakes are held in a released position by the air pressure supplied from the associated reservoir tank.

#### **CAUTION!!**

Do not attempt to drive the coach until system pressure is above 90 psi.

#### 4-13.1.3 Brake Failures

To compensate for normal lining wear, each brake system is individually self-adjusting.

Fail/safe features provide protection against brake system failures. If the front brakes fail, operating the brake treadle still activates the rear service brakes to provide stopping capability.

If a failure occurs in the rear, the front service brakes and rear spring brakes provide braking action.

In the unlikely event of a failure where both service-braking systems are disabled, the rear spring brakes will apply automatically and bring the vehicle to a stop. As a safety factor, the coach should not be driven until any type of brake failure is corrected.



**NOTE:** With the front brake system service reservoir fully charged, enough air pressure is available to provide for four full releases of the rear spring brakes. This will allow the coach to be brought to a safe position until repairs can be made.

#### 4-13.1.4 Anti-Lock Brakes

In addition to the above, a four-channel anti-lock brake system for the steer and drive axles are installed. In the event one of the wheels begins to lock up under severe braking conditions, the anti-lock system will detect this situation and gradually remove air pressure from the brake chamber until the wheel begins to turn. This will help assure smooth braking action and minimize wheel lockup.

#### 4-13.1.5 Air Suspension System

Air suspension bags cushion the front and rear axles. Ride height is automatically maintained by height control valves. Dumping these air bags when the vehicle is parked allows the rubber bumpers to come together and eliminate vehicle springiness. A switch, located on the lower left side of the LOWER DASH PANEL, controls dumping and filling of air bags. The SUSP. DUMP switch controls the front and rear suspension.

**NOTE:** The accessory air tank must contain at least 65 psi pressure for the DUMP switch to function. The accessory air tank pressure does not register on the dash air pressure gauges.

Moving the SUSP. DUMP switch away from the UP position applies air pressure to air pilot-operated valves on the suspension system. The pilot air shifts the valves, cutting off the air supply to the air bags and allows the air in the bags to escape. After the suspension system has been dumped and the ignition is turned on, a buzzer and a warning pilot light is illuminated on the dash to warn the driver that the system is dumped and not to drive the vehicle until the SUSP. DUMP switch is activated.

### 4-13.1.6 Additional Air-Operated Equipment

Besides providing the compressed air supply for the coach braking and suspension systems, the compressor also provides the air supply for the stepwell cover and entrance door lock, all via separately controlled solenoid switches operated from the dash, or at other locations throughout the coach. (This compressed air source is furnished from the front right side reservoir.) A compressed air outlet fitting and air gun are contained in a rear storage compartment on the road side of the coach, convenient for inflating tires, and so on. A Schrader valve (air connection) is available in the engine compartment to allow the air system to be pressurized from a "shop" source without the necessity of starting the engine. Two possible types of air dryers may be installed on the coach, either the AD-1 or the AD-2. Both are similar with just minor differences.

### 4-13.2 Compressed Air System Air Dryer

The air dryer unit collects and removes moisture and contaminants from the compressor air output before the air reaches the reservoirs. This unit is different from a reservoir drain or an after cooler in that it provides dry air for the brake system by eliminating the possible accumulation of condensation in the system reservoirs. Note that each reservoir also has a drain cock on the bottom for draining accumulated moisture. This assures a long maintenance-free life for air brake system components due to the removal of system contaminants.

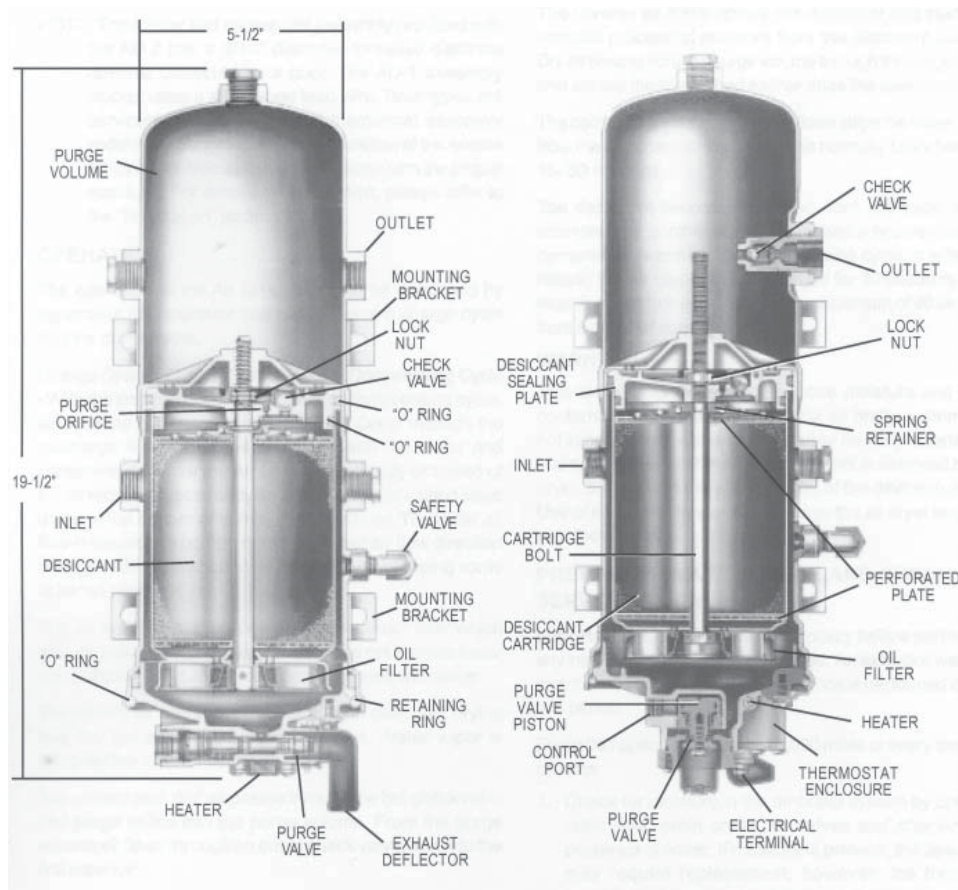

The air dryer is located between the compressor discharge (output) line and the compressed air reservoirs. A safety valve mounted in the air dryer housing assembly protects against excessive pressure buildup. The desiccant cartridge and pleated paper oil filters are easily removed and replaced as a complete serviceable unit. The desiccant “Beads” which provide the drying action have a large capacity for absorption due to their combined surface area. In addition, an internal thermostatically controlled heating element prevents freeze ups on the purge rail valve when the unit is used during sub-freezing temperatures.

The desiccant beads, which are referred to as the “drying bed”, are a drying substance that has the unique property of exposing a tremendous surface area in proportion to its bulk. One pound of the desiccant beads has about two million square feet of adsorptive area made up of a large number of submicroscopic cavities in each bead. Each desiccant bead adsorbs or collects moisture.

Purging of the dryer is automatic, exhausting combined oil and water residue to the atmosphere. At the same time that the contaminants are purged, the reverse airflow across the desiccant material removes the accumulated moisture and reactivates the desiccant. Refer to the following paragraphs for an explanation of basic operation of the air dryer including the charge cycle as well as the purge cycle.

### 4-13.2.1 Operation

The operation of the Air Dryer can best be described by separating the operation into two cycles; the charge cycle and the purge cycle.

**Charge Cycle Compressor in Compressing Cycle** - With the compressor in its “loaded” or compressing cycle, air from the compressor enters the Air Dryer through the discharge line. When the air, along with the water and contaminants, enter the Air Dryer, the velocity or speed of the air reduces substantially and much of the entrained liquid drops to the bottom or sump of the Air Dryer. The initial air flow is toward the bottom of the dryer, but air flow direction changes 180° at the bottom of the Air Dryer, dropping some water and oil.

The air now passes through the oil separator filter which removes oil and foreign material but does not remove water vapor. At this point, the air remains saturated with water.

The filtered air and vapors penetrate the desiccant drying bed and the adsorption process begins. Water vapor is removed from the air by the desiccant.

The unsaturated “dry” air passes through the ball check valve and purge orifice into the purge volume. From the purge volume air flows through an outlet check valve, and into the first reservoir.

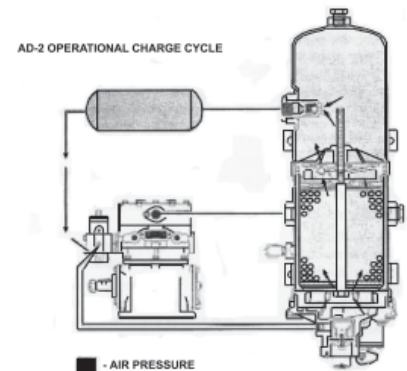

**NOTE:** The AD-1 Air Dryer does not incorporate an integral outlet check valve. The single check valve in an AD-1 installation would be located in the line between the AD-1 outlet port and the first reservoir.

**Purge Cycle** - When desired system pressure is reached, the governor cuts out, pressurizing the unloader cavity of the compressor which unloads the compressor (non-compressing cycle). The line connecting the governor unloader port to the end cover purge valve port (bottom of the Air Dryer) is also pressurized, opening the exhaust of the purge valve to atmosphere. With the exhaust of the purge valve open, contaminants in the discharge line and dryer sump are purged, or forced past the open exhaust out into the atmosphere.

The reverse air flows across the desiccant and starts the removal process of moisture from the desiccant surface. Dry air flowing from the purge volume through the purge orifice and across the drying bed further dries the desiccant.

The combination of these reverse flows strips the water vapor from the desiccant (drying bed). This normally takes between 15-30 seconds.

The desiccant becomes activated from this cycle and is now ready for another charge cycle, which occurs when the compressor returns to the compressing cycle. It is for this reason the air dryer must be purged for 30 seconds, after receiving moisture saturated air for a maximum of 90 seconds from a 12 CFM compressor.

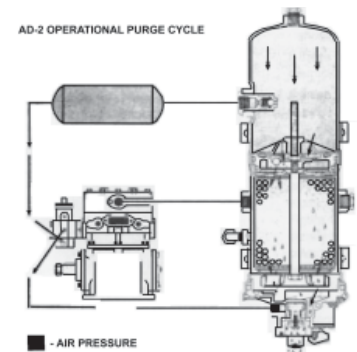

### WARNING!!

This air dryer is intended to remove moisture and other contaminants normally found in the air brake system. Do not inject alcohol, anti-freeze, or other de-icing substances into or upstream of the air dryer. Alcohol is removed by the dryer, but reduces the effectiveness of the device to dry air. Use of other substances can damage the air dryer and may void the warranty.



## 4-14 Appliances

Your vehicle is supplied with the following standard appliances. There are several optional appliances that can be purchased in addition or instead of the ones listed here. Please see a Coachwork's representative for clarification on these items.

### 4-14.1 Sharp Carousel Convection Microwave Oven

### 4-14.2 Important Safety Instructions

When using electrical appliances basic safety precautions should be followed, including the following:

**WARNING!!**

**To reduce the risk of burns, electric shock, fire, injury to persons or exposure to excessive microwave energy:**

1. Read all instructions before using the appliance.
2. Read and follow the specific "PRECAUTIONS TO AVOID POSSIBLE EXPOSURE TO EXCESSIVE MICROWAVE ENERGY" immediately following these steps.
3. Some products such as whole eggs and sealed containers - for example, closed glass jars - may explode and should not be heated in this oven.
4. Stir liquids briskly before and after heating to avoid eruption.
5. Use this appliance only for its intended use as described in this manual. Do not use corrosive chemicals or vapors in this appliance. This type of oven is specifically designed to heat, cook or dry food. It is not designed for industrial or laboratory use.
6. As with any appliance, close supervision is necessary when used by children.
7. Do not operate this appliance if it has a damaged cord or plug, if it is not working properly or if it has been damaged or dropped.
8. This appliance should be serviced only by qualified service personnel. Contact nearest Sharp Authorized Service dealer for examination, repair or adjustment.
9. Do not cover or block any openings on the appliance.
10. Do not immerse cord or plug in water.
11. Keep cord away from heated surfaces.
12. Do not let cord hang over edge of table or counter.
13. See door surface cleaning instructions under Cleaning and Care section.
14. To reduce the risk of fire in the oven cavity:
  - a. Do not overcook food. Pay close attention especially if paper, plastic or other combustible materials are placed inside the oven to facilitate cooking.
  - b. Remove wire twist-ties from paper or plastic bags before placing bag in oven.
  - c. If materials inside the oven should ignite, keep oven door closed, turn oven off and disconnect the power cord or shut off power at the fuse or circuit breaker panel before opening door.
  - d. Do not use the cavity for storage purposes. Do not leave paper products, cooking utensils or food in the cavity when not in use.
15. Clean ventilation openings and grease filters frequently - Grease should not be allowed to accumulate on ventilation openings, hood (louver) or grease filters.
16. Use care when cleaning the louver and the grease filters. Corrosive cleaning agents, such as lye-based oven cleaners, may damage the louver and the grease filters.
17. When flaming food under the hood, turn the fan on.
18. This appliance is suitable for use above both gas and electric cooking equipment 36" wide or less.

**PRECAUTIONS TO AVOID POSSIBLE EXPOSURE TO EXCESSIVE MICROWAVE ENERGY**

- Do not attempt to operate this oven with the door open since open-door operation can result in harmful exposure to microwave energy. It is important not to defeat or tamper with the safety interlocks.
- Do not place any object between the oven front face and the door or allow soil or cleaner residue to accumulate on sealing surfaces.
- Do not operate the oven if it is damaged. It is particularly important that the oven door close properly and that there is no damage to the: (1) door (bent), (2) hinges and latches (broken or loosened), (3) door seals and sealing surfaces.
- The oven should not be adjusted or repaired by anyone except properly qualified service personnel.

**4-14.3 Important Information****4-14.3.1 About Your Oven**

**This Operator's Manual offers valuable information: read it carefully and always save it for reference.**

A good microwave cookbook is a valuable asset. Check it for microwave cooking principles, techniques, hints and recipes. See [The Ultimate Accessory](#) section for ordering instructions for the Ultimate Accessory, the Sharp Carousel Microwave Cookbook.

**NEVER** use the oven without the turntable and support nor turn the turntable over so that a large dish could be placed in the oven. The turntable will turn both clockwise and counterclockwise. See [Manual Microwave Operation](#) for complete instructions.

**ALWAYS** have food in the oven when it is in use to absorb the microwave energy.

When using the oven at power levels below 100%, you may hear the magnetron cycling on and off.

The fan will automatically start when heat rises from range surface units or burners and when convection, high mix, low mix or the broil settings are used.

Condensation is a normal part of microwave cooking. Room humidity and the moisture in food will influence the amount of moisture that condenses in the oven. Generally, covered foods will not cause as much condensation as uncovered ones. Ventilation openings must not be blocked.

The oven is for food preparation only. It should not be used to dry clothes or newspapers.

The oven is rated 850 watts by using the IEC Test Procedure. When following recipes or package directions, check food a minute or two before the minimum time and add time accordingly.

**4-14.3.2 About Food**

FOOD	DO	DON'T
Eggs, sausages, fruits & vegetables	<ul style="list-style-type: none"> <li>Puncture egg yolks before cooking to prevent "explosion".</li> <li>Pierce skins of potatoes, apples, squash, hot dogs and sausages so that steam escapes.</li> </ul>	<ul style="list-style-type: none"> <li>Cook eggs in shells.</li> <li>Reheat whole eggs.</li> <li>Dry nuts or seeds in shells.</li> </ul>
Popcorn	<ul style="list-style-type: none"> <li>Use specially bagged popcorn for the microwave oven.</li> <li>Listen while popping corn for the popping to slow to 1 or 2 seconds or use special POPCORN pad.</li> </ul>	<ul style="list-style-type: none"> <li>Pop popcorn in regular brown bags or glass bowls.</li> <li>Exceed maximum time on popcorn package.</li> </ul>
Baby food	<ul style="list-style-type: none"> <li>Transfer baby food to small dish and heat carefully, stirring often. Check temperature before serving.</li> <li>Put nipples on bottles after heating and shake thoroughly. "Wrist" test before feeding.</li> </ul>	<ul style="list-style-type: none"> <li>Heat disposable bottles.</li> <li>Heat bottles with nipples on.</li> <li>Heat baby food in original jars.</li> </ul>
General	<ul style="list-style-type: none"> <li>Cut baked goods with filling after heating to release steam and avoid burns.</li> <li>Stir liquids briskly before and after heating to avoid "eruption".</li> <li>Use deep bowl, when cooking liquids or cereals, to prevent boilovers.</li> </ul>	<ul style="list-style-type: none"> <li>Heat or cook in closed glass jars or air tight containers</li> <li>Can in the microwave as harmful bacteria may not be destroyed.</li> <li>Deep fat fry.</li> <li>Dry wood, gourds, herbs or wet papers.</li> </ul>



### 4-14.3.3 About Microwave Cooking

- Arrange food carefully. Place thickest areas towards outside of dish.
- Watch cooking time. Cook for the shortest amount of time indicated and add more as needed. Food severely overcooked can smoke or ignite.
- Cover foods while cooking. Check recipe or cookbook for suggestions: paper towels, wax paper, microwave plastic wrap or a lid. Covers prevent spattering and help foods to cook evenly.
- Shield with small flat pieces of aluminum foil any thin areas of meat or poultry to prevent overcooking before dense, thick areas are cooked thoroughly.
- Stir foods from outside to center of dish once or twice during cooking, if possible.
- Turn foods over once during microwaving to speed cooking of such foods as chicken and hamburgers. Large items like roasts must be turned over at least once.
- Rearrange foods such as meatballs halfway through cooking both from top to bottom and from the center of the dish to the outside.
- Add standing time. Remove food from oven and stir, if possible. Cover for standing time which allows the food to finish cooking without overcooking.
- Check for doneness. Look for signs indicating that cooking temperatures have been reached.

**Signs that suggest food is done cooking include:**

- Food steams throughout, not just at edge.
- Center bottom of dish is very hot to the touch.
- Poultry thigh joints move easily.
- Meat and poultry show no pinkness.
- Fish is opaque and flakes easily with a fork.

### 4-14.3.4 About Safety

- Check foods to see that they are cooked to the United States Department of Agriculture's recommended temperatures.

TEMP	FOOD
160° F	. . .for fresh pork, ground meat, boneless white poultry, fish, seafood, egg dishes and frozen prepared food.
165° F	. . .for leftover, ready-to-reheat refrigerated, and deli and carry-out "fresh" food.
170° F	. . .white meat of poultry.
180° F	. . .dark meat of poultry.

To be sure meat is done cooking, insert a meat thermometer in a thick or dense area away from fat or bone. NEVER leave the thermometer in the food during cooking, unless it is approved for microwave oven use.

- Always use potholders to prevent burns when handling utensils that are in contact with hot food. Enough heat from the food can transfer through utensils to cause skin burns.
- Avoid steam burns by directing steam away from the face and hands. Slowly lift the farthest edge of a dish's covering and carefully open popcorn and oven cooking bags away from the face.
- Stay near the oven while it is in use and check cooking progress frequently so that there is no chance of overcooking food.
- Never use the cavity for storing cookbooks or other items.
- Select, store and handle food carefully to preserve its high quality and minimize the spread of food borne bacteria.
- Keep waveguide cover clean. Food residue can cause arcing and/or fires.
- Use care when removing items from the oven so that the utensil, your clothes or accessories do not touch the safety door latches.

### 4-14.3.5 About Children and the Microwave

Children below the age of 7 should use the microwave oven with a supervising person very near to them. Between ages 7 and 12, the supervising person should be in the same room.

The child must be able to reach the oven comfortably; if not, he/she should stand on a sturdy stool.

At no time should anyone be allowed to lean or swing on the oven door.

Children should be taught all safety precautions: use potholders, remove coverings carefully, pay special attention to packages that crisp food because they may be extra hot.

Don't assume that because a child has mastered one cooking skill he/she can cook everything.

Children need to learn that the microwave oven is not a toy. See Child Lock Feature later in this manual.

### 4-14.3.6 About Utensils and Coverings

It is not necessary to buy all new cookware. Many pieces already in your kitchen can be used successfully in your new microwave convection oven. The chart below will help you decide what utensils and coverings should be used in each mode.

UTENSILS AND COVERINGS	MICROWAVE ONLY	CONVECTION BROIL, SLOW COOK	HIGH MIX/ROAST LOW MIX/BAKE
Aluminum Foil	Yes Small flat pieces of aluminum foil placed smoothly on food can be used to shield areas from cooking or defrosting too quickly. Keep foil at least 1 inch from wall of oven.	Yes For shielding	Yes For shielding
Aluminum containers	Yes Can be used if 3/4 filled with food. Keep 1 inch away from walls and do not cover with lid.	Yes Broil - No cover	Yes Can be used if 3/4 filled with food. Keep 1 inch away from walls and do not cover with foil.
Browning dish	Yes Do not exceed recommended preheating time. Follow manufacturer's directions.	No	No
Glass ceramic (Pyroceram®)	Yes Excellent.	Yes Excellent.	Yes Excellent.
Glass, heat-resistant	Yes Excellent.	Yes Excellent.	Yes Excellent.
Glass, non-heat resistant	No	No	No
Lids, glass	Yes	Yes Broil - No cover	Yes
Lids, metal	No	Yes Broil - No cover	No
Metal cookware	No	Yes	Yes Do not use metal coverings.
Metal, misc: dishes with metallic trim, etc. Metal twist-ties	No	No	No
Oven cooking bags	Yes Good for large meals or foods that need tenderizing. DO NOT use metal twist-ties.	Yes Broil - No	Yes Do not use metal coverings.
Paper plates	Yes For reheating.	No	No
Paper towels	Yes to cover for reheating and cooking. Do not use recycled paper towels which may contain metal fillings.	No	No
Paper, ovenable	Yes	Yes for temperatures up to 400°F. Do not use for broiling.	Yes for temperatures up to 400°F.
Microwave-safe plastic containers	Yes Use for reheating and defrosting. Follow manufacturer's directions.	No	No
Plastic, Thermoset®	Yes	Yes Are heat resistant up to 425°F. Do not use for broiling.	Yes
Plastic wrap	Yes Use brands specially marked for microwave use. DO NOT allow plastic wrap to touch food. Vent so steam can escape.	No	No
Pottery, stoneware, porcelain	Yes Check manufacturer's recommendation to ensure item is microwave-safe.	Yes	Yes Must be microwave-safe and ovenable.
Styrofoam	Yes For reheating	No	No
Wax paper	Yes Good covering for cooking and reheating.	No	No
Wicker, wood, straw	Yes May be used for short periods of time. Do not use with high fat or high sugar content foods. Could char.	No	No

**DISH CHECK.** If you wish to check if a dish is safe for microwaving, place the empty dish in the oven and microwave on HIGH for 30 seconds. If the dish becomes very hot, DO NOT use it for microwaving, or if dish is new, check labels that accompanied dish when purchased.

**ACCESSORIES** There are many microwave accessories available for purchase. Evaluate carefully before you purchase so that they meet your needs. A microwave-safe thermometer will assist you in determining correct doneness and assure you that foods have been cooked to safe temperatures. Sharp is not responsible for any damage to the oven when accessories are used.

## 4-14.4 Part Names

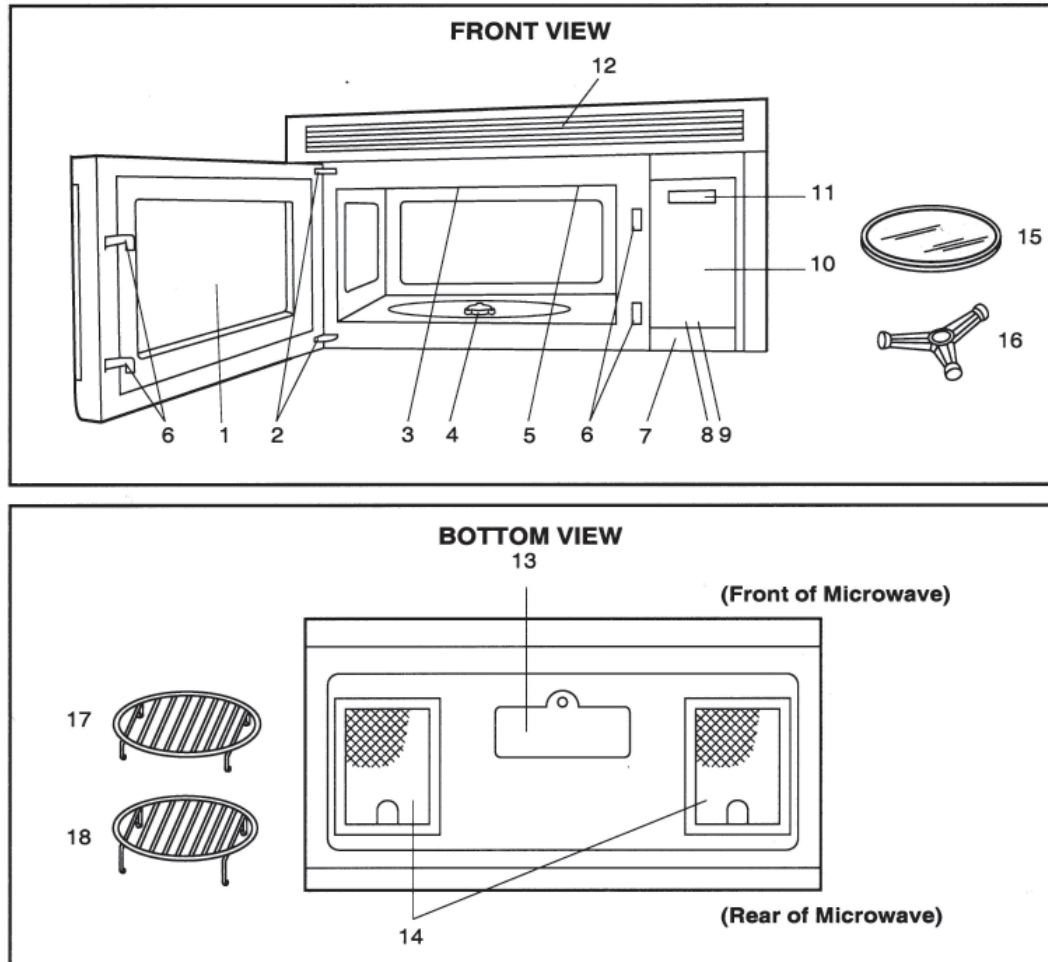

1. Oven door with see-through window.
2. Door hinges.
3. Waveguide cover DO NOT REMOVE.
4. Turntable motor shaft.
5. Oven light. Lights when oven is operating or door is open.
6. Safety door latches. The oven will not operate unless the door is securely closed.
7. One touch DOOR OPEN button. Push to open door.
8. FAN HI/LO button. Push for high/low/off.
9. LIGHT button. Push for on/off.
10. Auto-Touch control panel.
11. Time display: Digital display, 99 minutes 99 seconds.
12. Ventilation openings.
13. Light cover.
14. Grease filters.
15. Removable ceramic turntable. The turntable will rotate clockwise or counterclockwise. Only remove for cleaning.
16. Removable turntable support. Place the turntable support on the floor of the oven cavity and the turntable on the turntable support.
17. Removable low rack for broiling and meat and poultry roasting.
18. Removable high rack for two level baking.

# 4-14.5 Touch Control Panel

## MODEL R-1874

### INTERACTIVE DISPLAY

Words will light in the display to indicate features and cooking instructions.

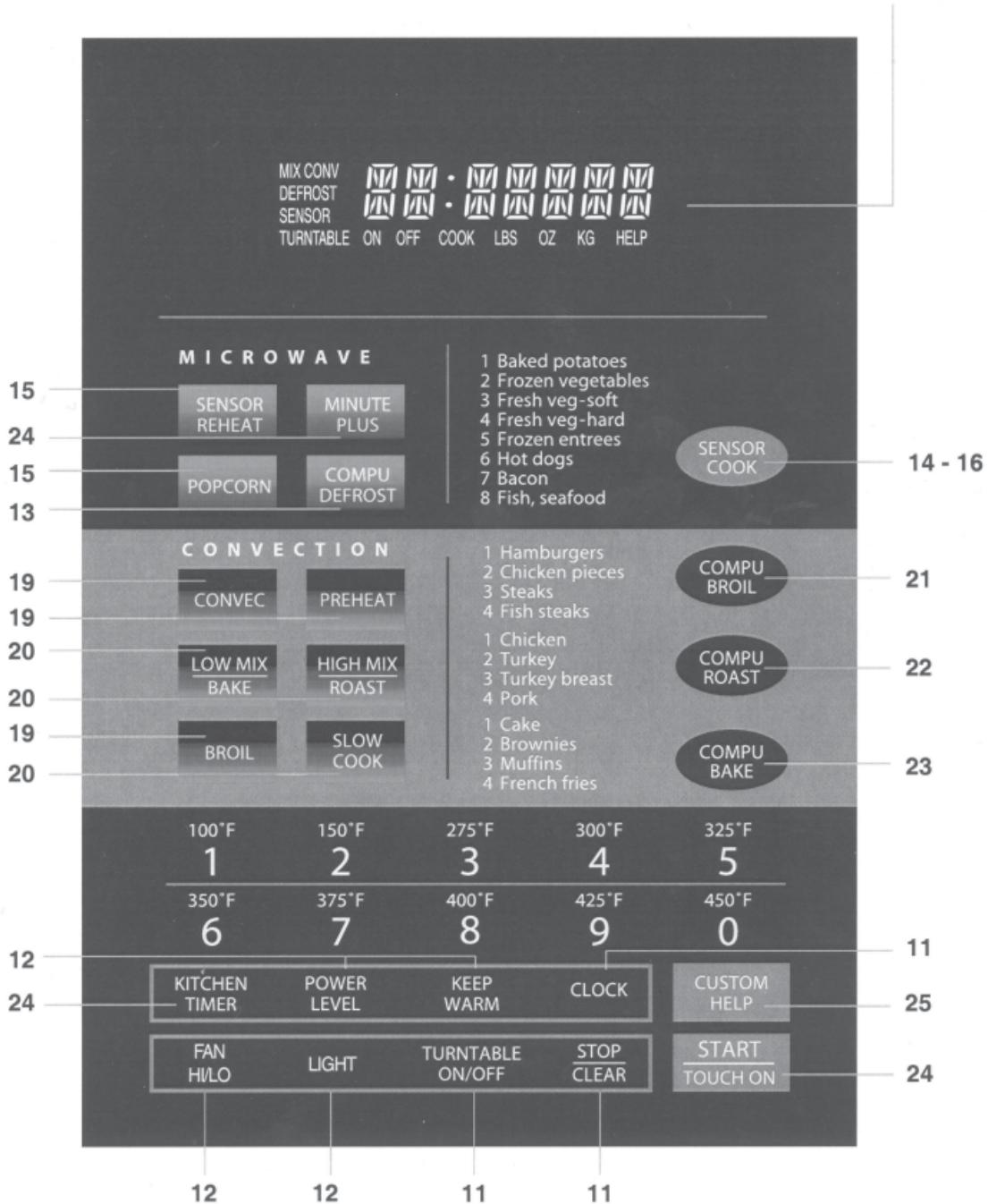





Number next to the control panel illustration indicates page on which there are feature descriptions and usage information.

## 4-14.6 Before Operating

- Before operating your new microwave oven make sure you read and understand this operation manual completely.
- Before the oven can be used, follow these procedures:
  1. Plug in the oven. Close the door. The oven display will show **SHARP SIMPLY THE BEST PRESS CLEAR AND PRESS CLOCK.**
  2. Touch the STOP/CLEAR pad. : will appear.
  3. Touch CLOCK and follow directions to set.

### 4-14-6.1 To Set the Clock

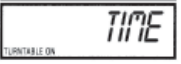
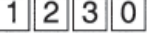
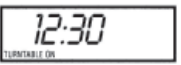
Suppose you want to enter the correct time of day 12:30 (a.m. or p.m.) Follow these 3 easy steps:

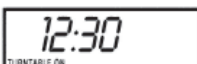
PROCEDURE	DISPLAY
<b>1</b>  Touch <b>CLOCK</b> pad.	 
<b>2</b>  Enter the correct time of day by touching the numbers in sequence.	
<b>3</b>  Touch <b>CLOCK</b> pad.	

This is a 12 hour clock. If you attempt to enter an incorrect clock time, ERROR will appear in the display. Touch the STOP/CLEAR pad and re-enter the time.

1. If the electrical power supply to your microwave oven should be interrupted, the display will intermittently show **SHARP SIMPLY THE BEST PRESS CLEAR AND PRESS CLOCK** after the power is reinstated. If this occurs during cooking, the program will be erased. The time of day will also be erased. Simply touch STOP/CLEAR pad and reset the clock for the correct time of day.

**NOTE:** Your oven can be programmed with the door open except for START/TOUCH ON, MINUTE PLUS, SENSOR REHEAT and POPCORN.

### 4-14.6.2 Stop/Clear

Touch the STOP/CLEAR pad to:

1. Erase if you make a mistake during programming.
2. Cancel kitchen timer.
3. Stop the oven temporarily during cooking.
4. Return the time of day to the display.
5. Cancel a program during cooking, touch twice.









## 4-14.7 Manual Microwave Operation

### 4-14.7.1 Turntable On/Off

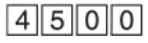
For most cooking, the turntable should be on; however the turntable can be turned off so that it does not rotate when extra large dishes, such as the popular 13"x9"x2" glass utility casserole, are used. The casserole should be placed on the turntable so that it is level.

Suppose you want to cook lasagna in a 13"x9"x2" casserole for 45 minutes on 40% power. Follow the steps in illustration at right.

**NOTE:** The door can be opened for checking food and the turntable will stay in the off position. After checking, close door and touch START/TOUCH ON.

PROCEDURE	DISPLAY
<b>1</b>  Touch <b>TURNTABLE ON/OFF</b> pad and note <b>TURNTABLE OFF</b> in the display.	
<b>2</b>  Enter cooking time.	
<b>3</b>   Enter power level.	
<b>4</b>  Touch <b>START/TOUCH ON</b> pad.	

The turntable will stay off for one minute after door is opened when time-of-day appears in the display. It is possible to reprogram the oven during that minute without touching the TURNTABLE ON/OFF pad. The display always indicates whether the turntable is off or on.

The TURNTABLE SHOULD ALWAYS BE ON WHEN USING THE SPECIAL FEATURES. On/off function can be used with manual cooking modes and Sensor Reheat. Turntable off condition will automatically change to On condition when you select auto cooking except Sensor Reheat and CompuBake.

When cooking large quantities of food which cannot be stirred, it is best to use a lower power level such as 40 or 50%. You may speed cooking of large amounts by programming 5 to 10 minutes on 100% power (HIGH) followed by the desired time on lower power. See [Multiple Sequence Cooking](#) section later in manual to program multiple sequences. You may wish to reverse a large casserole once during cooking; simply open door, reposition casserole door and touch START/TOUCH ON.

### 4-14.7.2 Hood Light/Hood Fan

Your oven is equipped with a Hood Light and a Hood Fan which can be used whether the door is open or closed.

To turn the Hood Light on, touch the LIGHT pad once.

To turn the Hood Light off, touch the LIGHT pad again.

To turn the Hood Fan on, touch the FAN HI/LO pad once for high speed. To turn the Hood Fan to low speed, touch pad twice and touch the pad three times to turn the fan off.

### 4-14.7.3 Time Cooking - Microwave

Your oven can be programmed for 99 minutes 99 seconds (99.99). Always enter the seconds after the minutes, even if they are both zeros.

Suppose you want to cook for 5 minutes at 100%, just follow instructions to the right.

PROCEDURE	DISPLAY
1  Enter cooking time.	
2  Touch <b>START/TOUCH ON</b> pad.	

PROCEDURE	
1	Touch the desired cook time for 1 baked potato. (Ex: 4 minutes.)
2	Touch <b>KEEP WARM</b> pad.
3	Touch <b>START/TOUCH ON</b> pad.

### 4-14.7.4 Keep Warm

**KEEP WARM** can only be programmed with manual cooking or as a separate program.

Suppose you want to cook a baked potato for 4 minutes at 100% power and you want to keep it warm after cooking for 30 minutes. Follow steps at right.

To use **KEEP WARM** as a separate program, touch **KEEP WARM** pad within 1 minute after cooking, closing the door or touching the **STOP/CLEAR** pad.

At the end of cook time, **KEEP WARM** is displayed warming food until end of 30 minutes.

### 4-14-7.5 To Set Power Level

There are eleven preset power levels. (see illustration at right)

Using lower power levels increases the cooking time which is recommended for foods such as cheese, milk and long slow cooking of meals. Consult cookbook or recipes for specific recommendations.

Suppose you want to defrost for 5 minutes at 30% with the turntable on.

TOUCH POWER LEVEL PAD ONCE THEN TOUCH	APPROXIMATE PERCENTAGE OF POWER	COMMON WORDS FOR POWER LEVELS
POWER LEVEL	100%	High
9	90%	
8	80%	
7	70%	Medium High
6	60%	
5	50%	Medium
4	40%	
3	30%	Med Low/Defrost
2	20%	
1	10%	Low
0	0%	

PROCEDURE	DISPLAY
1  Enter defrosting time.	
2  Touch <b>POWER LEVEL</b> pad. Enter power level.	
3  Touch <b>START/TOUCH ON</b> pad.	

## 4-14.8 Microwave Features

### 4-14.8.1 CompuDefrost

CompuDefrost automatically defrosts ground meat, steaks and chicken pieces.

Suppose you want to defrost a 2.0 pound steak. Follow the 6 steps below:

PROCEDURE	DISPLAY
<b>1</b> Touch <b>COMPU DEFROST</b> pad once. Then touch <b>COMPU DEFROST</b> pad two more times to select steak.	
<b>2</b> Enter weight by touching the number pads. (Ex. 2.0 lb)	
<b>3</b> Touch <b>START/TOUCH ON</b> pad.  The oven will stop and directions will be displayed. Follow the indicated message.	
<b>4</b> After the 1st stage, open the door. Turn steak over and shield any warm portions. Close the door. Touch <b>START/TOUCH ON</b> pad.	
<b>5</b> Touch <b>START/TOUCH ON</b> pad.	
<b>6</b> After defrost cycle ends, cover and let stand as indicated in chart below.	

#### NOTE:

- The weight can be entered in increments of 0.1 lb. If you attempt to enter more or less than the allowed amount ERROR WEIGHT TOO SMALL or TOO LARGE will appear in the display.
- CompuDefrost can be programmed with More/Less Time Adjustment. See [More or Less Time Adjustment](#) section later in manual.
- To defrost other foods or foods above or below the weights allowed on CompuDefrost Chart, use time and 30% power. See [Manual Defrost](#) section later in manual.

### 4-14.8.2 CompuDefrost Chart

TOUCH COMPU DEFROST PAD*	FOOD	FOR AMOUNT	PROCEDURE
once	Ground Meat	0.5-3.0 lb. (0.2 - 1.4 kg)	Remove any thawed pieces after each stage. Let stand, covered, for 5 to 10 minutes.
twice	Steaks (chops, fish)	0.5-4.0 lb. (0.2 - 1.8 kg)	After each stage of defrost cycle, rearrange and if there are warm or thawed portions, shield with small flat pieces of aluminum foil. Remove any meat or fish that is nearly defrosted. Let stand, covered, for 10 to 20 minutes.
3 times	Chicken Pieces	0.5-3.0 lb. (0.2 - 1.4 kg)	After each stage of defrost cycle, if there are warm or thawed portions, rearrange or remove. Let stand, covered, for 10 to 20 minutes.

\*Number of touches AFTER initial touch to access COMPUDEFROST.

**NOTE:** Check foods when oven signals. After final stage, small sections may still be icy. Let stand to continue thawing. Do not defrost until all ice crystals are thawed. Shielding prevents cooking from occurring before the center of the food is defrosted. Use small smooth strips of aluminum foil to cover edges and thinner sections of the food.

### 4-14.8.3 Manual Defrost

If the food that you wish to defrost is not listed on the CompuDefrost Chart or is above or below the limits in the “Amount” column on the chart, you need to defrost manually.

You can defrost any frozen food, either raw or previously cooked, by using power level 3. Follow the exact 3-step procedure found under [To Set Power Level](#) section found previously. Estimate defrosting time and press 3 for 30% when you select the power level.

For either raw or previously cooked frozen food, the rule of thumb is approximately 5 minutes per pound. For example, defrost 5 minutes for 2-3 cups of casserole or 1 pound of frozen spaghetti sauce.

Always stop the oven periodically to remove or separate the portions that are defrosted. If food is not defrosted at the end of the estimated defrosting time, program the oven in 1 minute increments on power level 3 until totally defrosted.

When using plastic containers from the freezer, defrost only long enough to remove from the plastic in order to place food in a microwave safe dish.

### 4-14.8.4 Sensor Cooking

Sharp’s Sensor is a semi-conductor device that detects the vapor (moisture and humidity) emitted from the food as it heats. The Sensor adjusts the cooking times and power level for various foods and quantities. It takes the guesswork out of microwave cooking.

#### Using Sensor Settings:

1. Room temperature should not exceed 95°F.
2. Be sure the exterior of the cooking container and the interior of the oven are dry. Wipe off any moisture with a dry cloth or paper towel.
3. Sensor cooking can only be entered within 1 minute after cooking, opening and closing the door or touching the STOP/CLEAR pad.
4. During the first part of sensor cooking, SENSOR REHEAT, POPCORN REGULAR SENSOR, BAKED POTATO, FROZEN VEG, SOFT FRESH VEG, HARD FRESH VEG, FROZEN ENTRÉE, HOT DOGS, BACON or FISH will appear on display. Do not open oven door or touch STOP/CLEAR during this part of the cooking cycle. The measurement of vapor will be interrupted. If this occurs, ERROR will appear and sensor cooking will be interrupted. To continue cooking, touch the STOP/CLEAR pad and select cooking time and power. When sensor detects the vapor emitted from the food, remainder of cooking time will appear. Door may be opened when remaining cooking time appears on display. At this time, you may stir or season food, as desired.
5. Check food for doneness after cooking with sensor settings. If additional time is needed, continue to cook with variable power and time.
6. If the sensor does not detect vapor, ERROR will appear and the oven will shut off.
7. At the end of any cycle, open oven door or touch STOP/CLEAR pad. The time of day will reappear on the display.
8. Any sensor setting can be programmed with More or Less Time Adjustment. See [More or Less Time Adjustment](#) section later in manual.

#### Selecting Foods:

1. The sensor works with foods at normal storage temperature. For example, foods for reheating would be at refrigerator temperature and potatoes for baking would be room temperature.
2. More or less food than the quantity listed in the charts should be cooked by time and variable power.

#### Covering Foods:

Some foods work best when covered. Use the cover recommended in the Sensor Cooking chart for these foods.

1. Casserole lid.
2. Plastic wrap: Use plastic wrap recommended for microwave cooking. Cover dish loosely; allow approximately ½ inch to remain uncovered to allow steam to escape. Plastic wrap should not touch food.
3. Paper towel: Use paper towels to absorb excess fat and moisture when cooking bacon and potatoes. Line the turntable when baking potatoes.
4. Wax paper: Cover dish completely; fold excess wrap under dish to secure. If dish is wider than paper, overlap two pieces at least one inch to cover.



### 4-14.8.5 Instant Sensors

Your oven has Instant Sensor Popcorn and Instant Sensor Reheat. To use any of the Instant Sensors, simply touch the chosen pad. The oven will start automatically. Any sensor setting can be programmed with More/Less Time Adjustment.

### 4-13.8.6 Instant Sensor Reheat

#### Turntable On:

You can reheat many foods by touching just one pad. You don't need to calculate reheating time or power level. To reheat food with turntable on, simply touch the SENSOR REHEAT pad.

#### Turntable Off:

You may reheat a 11"x8"x2" or 13"x9"x2" casserole with the turntable off. First touch TURNTABLE ON/OFF and note indicator. Then touch SENSOR REHEAT. The display will indicate turntable off and oven will start automatically. After cooking, LET STAND COVER will be displayed.

### 4-14.8.7 Instant Sensor Popcorn

Suppose you want to pop a 3.5 oz. bag of popcorn.

This sensor setting works well with most brands of microwave popcorn. You may wish to try several and choose your favorite. Pop only one bag at a time. Unfold the bag and place in oven according to directions.

TOUCH POPCORN PAD	FOR AMOUNT
once	3.0 and 3.5 oz. bag (regular size)
twice	1.5 and 1.75 oz. bag (snack size)

### 4-14.8.8 Instant Sensor Chart

FOOD	AMOUNT	PROCEDURE
Leftovers such as rice, potatoes, vegetables casserole	4-32 oz.	Place in dish or casserole slightly larger than amount to be reheated. Flatten, if possible. Cover with lid, plastic wrap or wax paper. Use covers such as plastic wrap or lids with larger quantities of more dense foods such as stews.
Soups	1-4 cups	After reheating, stir well if possible. Foods should be very hot. If not, continue to heat with variable power and time. After stirring, recover and allow to stand 2 to 3 minutes.
Canned entrees and vegetables	4-16 oz.	Use less Time Adjustment by touching POWER LEVEL pad twice for small quantities of canned vegetables.
Dinner Plate 1 plate	3-6 oz. of meat plus vegetables and/or potato/ rice	Use this pad to reheat precooked foods from the refrigerator. Place meaty portions and bulky vegetables to outside of plate. Cut large items like baked potatoes in smaller pieces. Flatten foods such as mashed potatoes and other dense foods. Cover with wax paper or plastic wrap. ONE PLATE ONLY. After cooking, check that food is very hot throughout and that the bottom center of the plate is very hot. If not, continue heating using time and power level. Allow to stand, covered, 2 to 3 minutes.
Popcorn	Only 1 package at a time	Use only popcorn packaged for microwave oven use. Try several brands to decide which you like best. Do not try to pop unpopped kernels. More/Less Time Adjustment can be used to provide adjustment needed for older popcorn or individual tastes. Stop cooking when there is 1 to 2 seconds between pops..

#### PROCEDURE

SENSOR REHEAT

Touch **SENSOR REHEAT** pad. (Note : Sensor Reheat can be programmed with turntable on or off).

SENSOR REHEAT will be displayed repeatedly. When sensor detects the vapor emitted from the food, remainder of cooking time will appear. After cooking, LET STAND COVER will be displayed.

#### PROCEDURE

POPCORN

Touch **POPCORN** pad once. (Ex: Touch **POPCORN** once for regular size bag.)

SENSOR POPCORN REGULAR will be displayed repeatedly. After cooking, END will be displayed.

### 4-14.8.10 Sensor Cook

Suppose you want to cook a baked potato. Just follow the directions at the right.

Open oven door or touch STOP/CLEAR pad. The time of day will appear in the display.

PROCEDURE	DISPLAY
<b>1</b> <b>SENSOR COOK</b> Touch <b>SENSOR COOK</b> pad.	<b>SELECT</b> <b>FOOD</b> <b>NUMBER</b>
<b>2</b> <b>1</b> Select desired sensor setting. Touch <b>1</b> to cook baked potatoes.	<b>BAKED</b> <b>POTATO</b> <b>PRESS</b> <b>START</b>
Touch <b>START/TOUCH ON</b> pad. When sensor detects the vapor emitted from the food, the remainder of cooking time will appear.	<b>LET</b> <b>STAND</b> <b>COVER</b>

Open oven door or touch **STOP/CLEAR** pad. The time of day will appear in the display.

FOOD	AMOUNT	PROCEDURE
1. Baked potatoes	1-6 medium	Pierce. Place on paper-towel-lined turntable. After cooking, remove from oven, wrap in aluminum foil and let stand 5 to 10 minutes.
2. Frozen vegetables	1-6 cups	Cover with lid or plastic wrap. After cooking, stir and let stand 3 minutes, covered.
3. Fresh vegetables - soft Broccoli Brussels sprouts Cabbage Cauliflower (flowerets) Cauliflower (whole) Spinach Zucchini Baked apples	0.25-2.0 lb. 0.25-2.0 lb. 0.25-2.0 lb. 0.25-2.0 lb. 1 medium 0.25-2.0 lb. 0.25-2.0 lb. 2-4 medium	Wash and place in casserole. Add no water if vegetables have just been washed. Cover with lid for tender vegetables. Use plastic wrap for tender-crisp vegetables. Stir before standing, if possible. After cooking, let stand, covered, 2 to 5 minutes.
4. Fresh vegetables - firm Carrots, sliced Corn on the cob Green beans Winter squash: diced halves	0.25-1.5 lb. 2-4 pcs. 0.25-1.5 lb. 0.25-1.5 lb. 1-2	Place in casserole. Add 1-4 tbsp. water. Cover with lid for tender vegetables. Use plastic wrap cover for tender-crisp vegetables. Stir before standing, if possible. After cooking, let stand, covered, 2 to 5 minutes.
5. Frozen entrees	6-17 oz.	Use for frozen convenience food. It will give satisfactory results for most brands. You may wish to try several and choose your favorite. Remove package from outer wrapping and follow package directions for covering. After cooking, let stand, covered, for 1 to 3 minutes.
6. Hot dogs	1-4 servings	Place hot dog in bun and wrap in paper towel or paper napkin.
7. Bacon	2-6 slices	Place bacon on paper plate, lined with paper towel. Bacon should not extend over the rim of plate. Cover with paper towel
8. Fish, seafood	0.25-2.0 lb.	Arrange in ring around shallow glass dish (roll fillet with edges underneath). Cover with vented plastic wrap. After cooking, let stand, covered, 3 minutes.

## 4-15.9 Manual Convection/Automatic Mix Operation

This section of the Operation manual gives you specific cooking instructions and procedures. Please consult your Sharp Carousel Convection Microwave Cookbook for helpful hints for convection and combination cooking.















The oven should not be used without the turntable in place, and it should never be restricted so that it cannot rotate. You may remove the turntable when preheating the oven and when preparing food to be cooked directly on the turntable.

### 4-15.9.1 Convection Cooking

During convection heating, hot air is circulated throughout the oven cavity to brown and crisp foods quickly and evenly. This oven can be programmed for ten different convection cooking temperatures for up to 99 minutes, 99 seconds.

### 4-15.9.2 To Cook with Convection

Suppose you want to cook at 350°F for 20 minutes. Follow directions in illustration below.























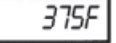

PROCEDURE	DISPLAY
<b>1</b>  Touch <b>CONVEC</b> pad.	 
<b>2</b> Touch number pad for desired temperature. (Ex: Pad  for 350°F.)	   
<b>3</b> Enter cooking time. (Ex:     min.)	
<b>4</b>  Touch <b>START/TOUCH ON</b> pad.	

### 4-15.9.3 To Preheat and Cook with Convection

Your oven can be programmed to combine preheating and convection cooking operations. You can preheat at the same temperature as the convection temperature or change it to a higher or lower temperature.

Suppose you want to preheat until 350°F and then cook 25 minutes at 375°F convection. Follow these simple instructions at right.

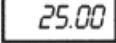
**NOTE:** To preheat and cook with the same temperature, enter same temperature in steps 2 and 3.











PROCEDURE	DISPLAY
<b>1</b>  Touch <b>PREHEAT</b> pad.	  
<b>2</b> Touch number pad for desired temperature. (Ex: Pad  for 350°F.)	     
<b>3</b> Touch <b>CONVEC</b> then touch number pad for temp. (Ex:  for 375°F)	     
<b>4</b> Enter number pads for cooking time. (Ex:     )	
<b>5</b> 	







Touch **START/TOUCH ON** pad.

### 4-14.9.4 To Broil

In the BROIL setting, preheating is automatic. Just enter the actual broiling time and wait for preheat to be over before adding food. (Preset 450°F). Oven temperature cannot be changed.

Suppose you want to broil a ham steak for 15 minutes. Refer to illustration at right for directions.

PROCEDURE	DISPLAY
<b>1</b>  Touch <b>BROIL</b> pad.	   
<b>2</b> Touch number pads to enter cooking time. (Ex:     )	
<b>3</b>  Touch <b>START/TOUCH ON</b> pad.	

PROCEDURE	DISPLAY
<b>1</b>  Touch <b>SLOW COOK</b> pad.	   
<b>2</b>  Touch <b>START/TOUCH ON</b> pad. The oven begins counting and continues to 4 hours.	

### 4-14.9.5 To Slow Cook

Slow Cook is a preset at 300°F. Slow Cook is programmed for 4 hours. Oven temperature can be changed to temperature below 300°F. Simply touch the SLOW COOK pad and touch the desired numbered pad with temperature below 300°F.

### 4-14.9.6 Automatic Mix Cooking

This oven has two pre-programmed settings that make it easy to cook with both convection heat and microwave automatically.

	OVEN TEMPERATURE	MICROWAVE POWER
HIGH MIX	325°F	30%
LOW MIX	325°F	10%

With the exception of those foods that cook best by convection heating alone, most foods are well suited to mix cooking using either LOW MIX/BAKE or HIGH MIX/ROAST.











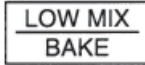



The marriage of these two cooking methods produces juicy meats, moist and tender cakes and fine textured breads, all with just the right amount of browning and crispness.

The temperature can be changed; however, the microwave power cannot.

The oven temperature can be changed from 100°F to 450°F. To change the temperature, first touch HIGH MIX or LOW MIX, then touch the same pad again. When the display says SELECT TEMP, touch desired temperature pad. Ex. HIGH MIX, HIGH MIX, pad 7 and START/TOUCH ON. The mix temperature will change automatically.

### 4-14.9.7 To Cook with Automatic Mix

Suppose you want to bake a cake at low mix for 20 minutes. See illustration at right.

PROCEDURE	DISPLAY
<b>1</b>  Touch <b>LOW MIX/BAKE</b> pad.	   
<b>2</b>      Touch number pads to select time.	  
At the end of the baking time, 1 long tone will sound and  will be displayed.	

## 4-14-9.8 To Preheat and Cook with Automatic Mix

Your oven can be programmed to combine preheating and Automatic Mix cooking operations. You can preheat at the same temperature as the present combination temperature or change it to a different temperature.

Suppose you want to preheat until 350°F and then cook 25 minutes on 325°F Low Mix bake. Follow the 5 steps at the right.

## 4-14.10 Convection Automatic Mix Features

This section of the operation manual offers instructions for preparing 12 popular foods using CompuBroil, CompuRoast and CompuBake. After selecting the desired feature, follow the directions indicated in the display.

For helpful hints, simply touch CUSTOM HELP anytime HELP is lighted in the display.

### 4-14.10.1 CompuBroil





















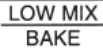



CompuBroil automatically broils hamburgers, chicken pieces, steaks and fish steaks.

Suppose you want to broil 2 hamburgers. Follow steps 1-5 on the right for directions.































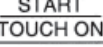

#### NOTE:

- CompuBroil can be programmed with More/Less Time Adjustment.
- If you attempt to enter more or less than the allowed weight **ERROR WEIGHT TOO LARGE PRESS CLEAR** or **ERROR WEIGHT TOO SMALL PRESS CLEAR** will appear in the display. If you enter more or less than the allowed number **ERROR O QTY PRESS CLEAR** or **ERROR TOO MANY PRESS CLEAR** will appear in the display.
- To broil other foods or foods above or below the weight or number allowed on the chart below, follow instructions in the Sharp Carousel Convection Microwave Cookbook. See [Broiling Chart](#) to follow.

To preheat and cook with the same temperature, enter same temperature in steps 2 and 3.

PROCEDURE	DISPLAY
<b>1</b> 	  
Touch <b>PREHEAT</b> pad.	
<b>2</b> Touch number pad for desired temperature (Ex: Pad  for 350°F.)	     
<b>3</b> 	   
Touch <b>LOW MIX/BAKE</b> pad.	
<b>4</b>    	  
Touch number pads to select time.	
<b>5</b> 	
Touch <b>START/TOUCH ON</b> pad.	

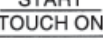
At the end of the baking time, 1 long tone will sound and  will be displayed.

PROCEDURE	DISPLAY
<b>1</b> 	  
Touch <b>COMPU BROIL</b> pad.	
<b>2</b> 	        
Touch number pad. (Ex: for hamburgers, touch  .)	
<b>3</b> 	      
Touch number pad to enter quantity. (Ex:  .) Follow information in display for cooking information.	
For well done or rare burgers, touch <b>POWER LEVEL</b> pad to select More for well done or Less for rare. See More/ Less Time Adjustment on page 24.	
<b>4</b> 	  <small>TEMPERATURE ON COOK</small>
Touch <b>START/TOUCH ON</b> pad.	
After broil preheat cycle ends, 4 long tones will sound.      will be displayed repeatedly. Open the door and place hamburgers into oven. Close the door.	
<b>5</b> 	Touch <b>START/TOUCH ON</b> pad.
After broil cycle ends, 1 long tone will sound and  will be displayed.	

### 4-14.10.2 CompuBroil Chart

SETTING/FOOD	AMOUNT	PROCEDURE
1. Hamburgers	1-8 pieces 1/4 lb each	Use this setting to broil hamburger patties. Place on low rack.
2. Chicken pieces	0.5-2.0 lb	Arrange pieces on low rack. After cooking, let stand, 3-5 minutes. Dark meat should be 180°F, and white meat should be 170°F.
3. Steaks	0.5-2.0 lb.	Use this setting to broil steaks from 3/4" to 1" thick. Individual boneless steaks broil evenly. Place steak on low rack. For well done, touch POWER LEVEL once; for rare, touch POWER LEVEL twice.
4. Fish steaks	0.5-2.0 lb.	Use this setting to broil fish steak which is 3/4" to 1" thick. Place on low rack.

### 4-14.10.3 CompuRoast

CompuRoast automatically roasts chicken, turkey, turkey breast or pork.

Suppose you want to roast a 2.5 pound chicken. Follow instructions on right.

**NOTE:**

- CompuRoast can be programmed with More/Less Time Adjustment.
- If you attempt to enter more or less than the allowed weight. ERROR WEIGHT TOO LARGE PRESS CLEAR or ERROR WEIGHT TOO SMALL PRESS CLEAR will appear in the display.
- To roast other food or foods above or below the weights allowed on the chart below, check the Sharp Carousel Convection Microwave Cookbook's Combination Roasting Chart.

PROCEDURE	DISPLAY
<b>1</b> <b>COMPU ROAST</b> Touch <b>COMPU ROAST</b> pad.	SELECT FOOD NUMBER
<b>2</b> <b>1</b> Touch number pad. (Ex: for chicken touch <b>1</b> .)	CHICKEN USE LOW RACK ENTER WEIGHT
<b>3</b> <b>2 5</b> Touch number pad to enter weight. (Ex: 2.5)	2.5 PRESS START
<b>4</b> <b>START TOUCH ON</b> Touch <b>START/TOUCH ON</b> pad.	

After COMPU ROAST cycle end, a long tone will sound. LET STAND COVERED FOR 5-10 MIN will be displayed.

### 4-14.10.4 CompuRoast Chart

SETTING FOOD	AMOUNT	RACK	PROCEDURE
1. Chicken	2-5 - 7.0 lb. (1.2 - 3.1 kg)	Low	After the cycle ends, cover with foil and let stand for 5-10 minutes. Internal temperature of white meat should be 170°F and of dark meat, 180°F.
2. Turkey (Unstuffed)	6.5 - 9.0 lb. (3.0 - 4.0 kg)	Low	Season, as desired. Place on low rack. After the cycle ends, cover with foil and let stand 10 minutes. Internal temperature of white meat should be 170°F and of dark meat, 180°F.
3. Turkey breast	3.0 - 6.0 lb. (1.4 - 2.7 kg)	Low	Season, as desired. Place on low rack. After the cycle ends, cover foil and let stand 10 minutes. Internal temperature of white meat should be 170°F.
4. Pork	2.0 - 3.5 lb. (0.9 - 1.5 kg)	Low	Boneless pork loin is recommended because it cooks evenly. Place on low rack. After cooking, remove from oven, cover with foil and allow to stand 5-10 minutes. Internal temperature should be 160°F.

### 4-14.10.5 Compu Bake

CompuBake automatically bakes cakes, brownies, muffins and French fries.

Follow steps 1 through 4 to bake a 13"x9"x2" cake.



**NOTE:**

1. CompuBake can be programmed with More/Less Time Adjustment.
2. To bake other food, see the Sharp Carousel Convection Microwave Cookbook's Baking Section.

PROCEDURE	DISPLAY
<p><b>1</b> <b>COMPU BAKE</b></p> <p>Touch <b>COMPU BAKE</b> pad. Note: Turntable function is automatically turned OFF.</p>	<p><b>SELECT</b> <b>FOOD</b></p> <p><b>NUMBER</b></p>
<p><b>2</b> <b>1</b></p> <p>Touch number pad. (Ex: for cake, touch <b>1</b>.)</p>	<p><b>CAKE</b></p> <p><b>USE</b> <b>13X9X2</b></p> <p><b>INCH</b> <b>METAL</b></p> <p><b>PAN</b> <b>ON</b></p> <p><b>LOW</b> <b>RACK</b></p> <p><b>NO FOOD</b> <b>IN OVEN</b></p> <p><b>PRESS</b> <b>START</b></p>

**3** **START TOUCH ON** **PREHEAT**

Touch **START/TOUCH ON** pad.

After CompuBake preheat cycle ends, 4 tones will sound. The display will indicate **PREHEAT** **OVER** **PLACE** **FOOD** **IN OVEN**. Open door. Place the cake pan inside. Close door and touch **START/TOUCH ON**.

**4** **START TOUCH ON** Touch **START/TOUCH ON** pad.

After **COMPU BAKE** cycle ends, 1 long tone will sound, and **END** will be displayed.







### 4-14.10.6 CompuBake Chart

SETTING FOOD	PAN SIZE/ QTY	RACK	PROCEDURE
1. Cake	13"x9"x2"	Low	Ideal for packaged cake mix or your own recipe for 13"x9"x2" pan. Prepare according to package or recipe directions and place in a greased and floured 13"x9"x2" baking pan. After the preheat is over, place pan in oven centered on low rack. Cool before frosting and serving.
2. Brownies	13"x9"x2"	Low	Ideal for packaged brownie mix or your own recipe for 13"x9"x2" pan. Prepare according to package or recipe directions and place in a greased and floured 13"x9"x2" baking pan. After the preheat is over, place pan in oven centered on low rack. Cool before cutting into serving pieces.
3. Muffins	12 cup Muffin pan	Low	Ideal for packaged muffin mix or your own recipe for 12 medium size muffins. Prepare according to package or recipe directions and place in one 12-cup muffin pan. After the preheat is over, place pan in oven centered on low rack.
4. French Fries	3 to 24 oz. Cookie sheet to hold	Low	Use frozen prepared French Fries. No preheat is required for the French Fries baking procedure. Place French Fries on cookie sheet on low rack. For shoestring potatoes, touch <b>POWER LEVEL</b> pad twice to enter less time before touching <b>START/TOUCH ON</b> pad.

## 4-14.11 Other Convenient Features

### 4-14.11.1 Multiple Sequence Cooking

The oven can be programmed for up to 4 automatic cooking sequences for the microwave mode and 3 automatic cooking sequences for convection mode, switching from one setting to another automatically.

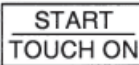
PROCEDURE		
1		Touch <b>POWER LEVEL</b> pad once.
2		Touch <b>POWER LEVEL</b> number. (Ex: 90%)
3		Enter cooking time. (Ex: 5 minutes.)
4		Touch <b>POWER LEVEL</b> pad again.
5		Touch <b>POWER LEVEL</b> number. (Ex: 50%)
6		Enter cooking time. (Ex: 30 minutes.)
7		Touch <b>START/TOUCH ON</b> pad.

Sometimes cooking directions tell you to start on one power level and then change to a different power level. Your oven can do this automatically.

Suppose you want to cook roast beef for 5 minutes at 90% and then continue to cook for 30 minutes at 50%. Follow the directions in illustration at left.

#### NOTE:

1. If **POWER LEVEL** pad is touched twice, **HIGH** will be displayed.
2. If 100% is selected as the final sequence, it is not necessary to touch the **POWER LEVEL** pad.
3. If you wish to know power level, simply touch the **POWER LEVEL** pad. As long as your finger is touching the **POWER LEVEL** pad, the power level will be displayed.

### 4-14.11.2 More or Less Time Adjustment

**More:** Should you discover that you like any of the **COMPUDEFROST**, **COMPUROAST**, **COMPUBAKE**, **COMPUBROIL**, **SENSOR COOK** or **INSTANT SENSOR** settings more done, touch the **POWER LEVEL** pad once after touching your choice of pads.

**Less:** Should you discover that you like any of the **COMPUDEFROST**, **COMPUROAST**, **COMPUBAKE**, **COMPUBROIL**, **SENSOR COOK** or **INSTANT SENSOR** settings slightly less done, touch the **POWER LEVEL** pad twice after touching your choice of pads.

### 4-14.11.3 Kitchen Timer

Suppose you want to time a 3 minute long distance phone call. Follow the steps in the illustration at right.

### 4-14.11.4 Minute Plus

Minute Plus allows you to cook for a minute at 100% by simply touching the **MINUTE PLUS** pad. You can also extend cooking time in multiples of 1 minute by repeatedly touching the **MINUTE PLUS** pad during manual cooking using microwave, convection, mix or broil.

Suppose you want to heat a cup of soup for one minute. Simply press the **MINUTE PLUS** pad once.

PROCEDURE		
1		Touch <b>KITCHEN TIMER</b> pad.
2		Enter time.
3		Touch <b>START/TOUCH ON</b> pad.

PROCEDURE		
		Touch <b>MINUTE PLUS</b> pad.

#### NOTE:

1. Touch **MINUTE PLUS** pad within 1 minute after cooking, closing the door, touching the **STOP/CLEAR** pad or during cooking. Minute Plus cannot be used to start the oven if any program is on display.
2. Minute Plus cannot be used with Special Features.



### 4-14.11.5 Demonstration Mode

To demonstrate, touch CLOCK, 0 and START/TOUCH ON and hold for three seconds. DEMO ON DURING DEMO NO OVEN POWER SHARP SIMPLY THE BEST and DEMO will appear in the display. Cooking operations and special features can now be demonstrated with no power in the oven. For example, touch MINUTE PLUS, and the display will show 1.00 and count down quickly to 0 and the END.

To cancel, touch CLOCK, the number 0 and STOP/CLEAR.

### 4-14.11.6 Help

Each setting of CompuDefrost, CompuBroil, CompuRoast, CompuBake and Sensor Cook has a cooking hint. If you wish to check, touch CUSTOM HELP whenever HELP is lighted in the Interactive Display.

### 4-14.11.7 Custom Help

Custom Help provides 5 features which make using your oven easy because specific instructions are provided in the Interactive Display.

#### 1. Child Lock

The Child Lock prevents unwanted oven operation such as by small children. Note: Child Lock is not applicable to Hood Fan and Hood Light buttons.

The oven can be set so that the control panel is deactivated or locked. To set, touch CUSTOM HELP, the number 1 and START/TOUCH ON pad. Should a pad be touched, LOCK will appear in the display.

To cancel, touch CUSTOM HELP, the number 1 and STOP/CLEAR.

#### 2. Audible Signal Elimination

If you wish to have the oven operate with no audible signal, touch CUSTOM HELP, the number 2 and STOP/CLEAR.

To cancel and restore the audible signal, touch CUSTOM HELP, the number 2 and START/TOUCH ON.

#### 3. Auto Start

If you wish to program your oven to begin cooking automatically at a designated time of day, follow this procedure below: Suppose you want to start cooking a stew for 20 minutes on 50% at 4:30. Before setting, check to make sure the clock is set correctly.



#### NOTE:

1. Auto Start can be used for manual cooking, CompuBroil/Roast/Bake, if clock is set.
2. If the oven door is opened after programming Auto Start, it is necessary to touch the START/TOUCH ON pad for the time of day to appear in the readout so that the oven will automatically begin programmed cooking at the chosen Auto Start time.
3. Be sure to choose foods that can be left in the oven safely until the Auto Start time. Baked potatoes are often a good choice.

#### PROCEDURE

- |          |                   |                                   |
|----------|-------------------|-----------------------------------|
| <b>1</b> | CUSTOM<br>HELP    | Touch <b>CUSTOM HELP</b> pad.     |
| <b>2</b> | 3                 | Touch the number.                 |
| <b>3</b> | 4 3 0             | Enter the start time.             |
| <b>4</b> | CLOCK             | Touch <b>CLOCK</b> pad.           |
| <b>5</b> | 2 0 0 0           | Enter cooking program.            |
| <b>6</b> | START<br>TOUCH ON | Touch <b>START/ TOUCH ON</b> pad. |

#### 4. Language Selection

The oven comes set for the English language. To change, touch CUSTOM HELP and the number 4. Continue to touch the number 4 until your choice is selected from the table below. Then touch START/TOUCH ON pad.

NUMBER 4	LANGUAGE	DISPLAY
Once	English	ENGLISH
Twice	Spanish	ESPAÑOL
3 times	French	FR

## 5. Weight/Temp Selection

The oven comes set for U.S. Customary Unit-pounds. To change, touch CUSTOM HELP and the number 5. Continue to touch the number 5 until your choice is selected from the list as shown on right. Then, touch START/TOUCH ON pad.

NUMBER 5	STANDARD OF WEIGHT AND TEMPERATURE	DISPLAY
Once	Pound/Fahrenheit	LB F
Twice	Kilogram/Celsius	KG C

### PROCEDURE

-  Continuously touch **START/TOUCH ON** pad. The cooking time will begin counting up.
- When the cheese is melted to desired degree, remove finger from **START/TOUCH ON** pad. Oven stops immediately.

## 4-14.11.8 Touch On

Touch On allows you to cook at 100% power by touching the START/TOUCH ON continuously. Touch On is ideal for melting cheese, bringing milk to just below boiling, etc. The maximum cooking time is 3 minutes.

*Suppose you want to melt cheese on a piece of toast. Follow the simple steps on left.*

### NOTE:

- Note time it takes for frequently used foods and program that time in the future.
- Touch the TOUCH ON pad within 1 minute after cooking, opening and closing the door or touching the STOP/CLEAR pad.
- TOUCH ON can only be used 3 times in a row. If more times are needed, open and close door or touch STOP/CLEAR.

## 4-14.12 Cleaning and Care

### 4-14.12.1 Exterior

The outside surface is pre-coated metal and plastic. Clean the outside with mild soap and water; rinse and dry with a soft cloth. Do not use any type of household or abrasive cleanser.

### 4-14.12.2 Door

Wipe the window on both sides with a damp cloth to remove any spills or splatters. Metal parts will be easier to maintain if wiped frequently with a damp cloth. Avoid the use of harsh abrasives.

### 4-14.12.3 Touch Control Panel

Care should be taken in cleaning the touch control panel. If the control panel becomes soiled, open the oven door to inactivate the control panel before cleaning. Wipe the panel with a cloth dampened slightly with water only. Dry with a soft cloth. Do not scrub or use any sort of chemical cleaners. Avoid the use of excess water. Close door and touch STOP/CLEAR.

### 4-14.12.4 Interior - After Microwave Cooking

The oven walls, ceiling and floor are stainless steel. Cleaning after microwave cooking is easy because no heat is generated to the interior surface; therefore, there is no baking and setting of spills or spattering. To clean the interior surface, wipe with a soft cloth and warm water. **DO NOT USE ABRASIVE OR HARSH CLEANERS OR SCOURING PADS.** For heavier soil, use mild soap; rinse thoroughly with hot water.

### 4-14.12.5 Interior - After Convection, Mix or Broil Cooking

Spatters may occur because of moisture and grease. Wash immediately after use with hot, soapy water. Rinse and polish dry. Harder to remove spatters may occur if oven is not thoroughly cleaned or if there is long time/high temperature cooking. If so, you may wish to purchase an oven cleaner pad with liquid cleaner within it-not a soap filled steel pad-for use on stainless or porcelain surfaces. Follow manufacturer's directions carefully and be especially cautious not to get any of the liquid cleaner in the perforations on the wall or ceiling or any door surfaces. Rinse thoroughly and polish dry.

### 4-14.12.6 Waveguide Cover

The waveguide cover is located on the ceiling in the oven cavity. It is made from mica so requires special care. Keep the waveguide cover clean to assure good oven performance. Carefully wipe with a damp cloth any food spatters from the surface of the cover immediately after they occur. Built-up splashes may overheat and cause smoke or possibly catch fire. **DO NOT REMOVE THE WAVEGUIDE COVER.**

### 4-14.12.7 Odor Removal

Occasionally, a cooking odor may remain in the oven. To remove, combine 1 cup water, grated peel and juice of 1 lemon and several whole cloves in a 2-cup glass measuring cup. Boil for several minutes using 100% power. Allow to set in oven until cool. Wipe interior with a soft cloth.

### 4-14.12.8 Turntable/Turntable Support

The ceramic turntable and turntable support can be removed for easy cleaning. Wash them in mild, sudsy water; for stubborn stains use a mild cleanser and scouring sponge as described above. They are also dishwasher-safe using top rack.



### 4-14.12.8 Oven Racks

The high and low baking racks can be removed for easy cleaning and stored away from the microwave oven when racks are not needed. After each use, wash them in mild, sudsy water. For any stubborn stains, use a mild kitchen cleanser and scouring sponge as described above. They are dishwasher-safe.



### 4-14.12.9 Grease Filters

Filters should be cleaned at least once a month. Never operate the fan or oven without the filters in place.

1. Pull the tab toward the front of the oven, down slightly and remove the filter. Repeat for the other filter.
2. Soak the filters in a sink or dish pan filled with hot water and detergent. **DO NOT** use ammonia or other alkali; they will react with the filter material and darken it.
3. Agitate and scrub with a brush to remove embedded dirt.
4. Rinse thoroughly and shake dry.
5. Replace by fitting the filter back into the opening.

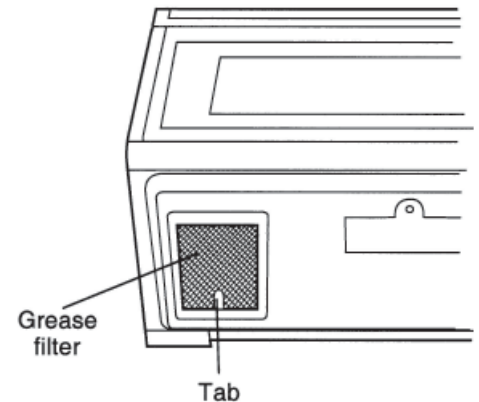

### 4-14.12.10 Fan

The fan will automatically start when heat rises from range surface units or burners and when convection, high mix, low mix or the broil settings are used. This protects the microwave oven from excessive temperature rise. The fan will stay on until the temperature decreases. It cannot be turned off manually during this time.

For other uses, select either high or low speed.

#### PRECAUTIONS FOR PROPER USE:

1. **DO NOT** leave range unattended while using high temperatures. Automatic fan may start and provide excessive air to the surface units. This may cause spattering or boil over.
2. Avoid burning food.
3. Keep grease filters clean.

### 4-14.12.11 Light

1. To replace light bulbs, first disconnect power to the oven at the circuit breaker panel or by unplugging.
2. To release cover remove the screw on the light cover. (see illustration)
3. Replace bulbs only with equivalent watt bulbs available from a Sharp Authorized Service or parts distributor. Bulbs are also available at most hardware stores or lighting centers. **DO NOT USE A BULB LARGER THAN 30 WATTS.**
4. Close light cover and secure with screw removed in step 2.

#### CAUTION!!

Light cover may become very hot. Do not touch glass when light is on. Do not use light for long time use such as a night light.

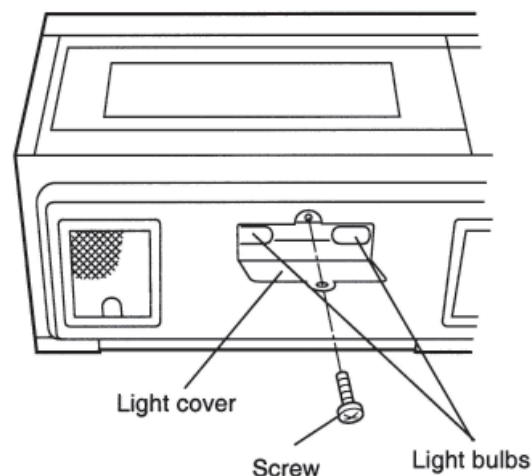

### 4-14.12.12 Charcoal Filter

Charcoal Filter, Sharp Part Number RK-220 is used for No-vented, re-circulated installation. The filter should be changed every 6 to 12 months depending on use.

1. Disconnect power to the oven at the circuit breaker panel or by unplugging.
2. Remove 3 screws that secure louver.
3. Remove louver by inserting flat edge of screwdriver over each tab depressing the tab down and moving louver away from unit.
4. Pull the louver away from the oven.
5. Slide Charcoal Filter into position on support tabs.
6. Push louver back into place and gently snap tabs into place by hand (engaging both the bottom and top tabs) and replace the 3 screws to secure louver.

### 4-14.12.13 Oven Light

Remove the louver per instructions 1-4 above and charcoal filter, if used.

1. Slide the light cover forward and lift up.
2. Remove old light bulb and replace only with an equivalent watt bulb available from a Sharp Authorized Servicer or parts distributor. Bulbs are also available at most hardware stores or lighting centers. **DO NOT USE A BULB LARGER THAN 30 WATTS.**
3. Replace the oven light cover and charcoal filter, if used; push louver back in place (engaging both the bottom and top tabs) and replace the louver mounting screws.

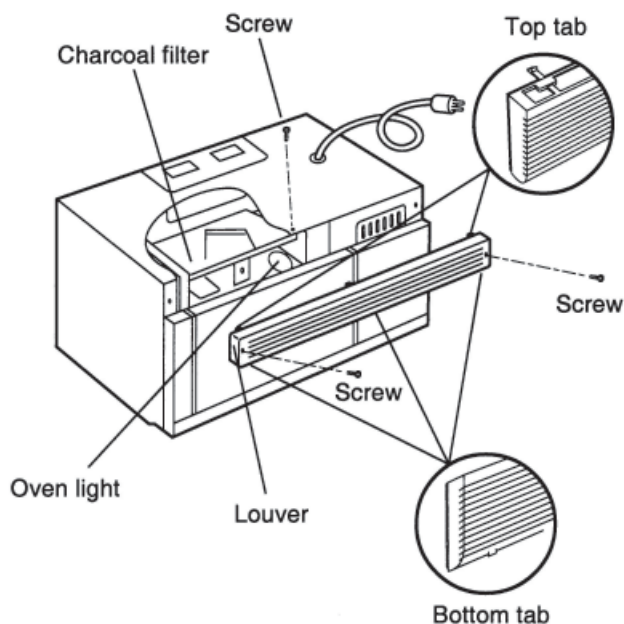

### 4-14.13 Auto-Touch Guide

<p><b>SET CLOCK</b></p> <p>If <b>SHARP</b> <b>SIMPLY</b> <b>THE</b> <b>BEST</b> <b>PRESS</b> <b>CLEAR</b> <b>AND</b> <b>PRESS</b> <b>CLOCK</b> is in the display, first touch <b>STOP/CLEAR</b>.</p> <ol style="list-style-type: none"> <li>1. Touch <b>CLOCK</b> pad.</li> <li>2. Enter correct time of day by touching numbers in sequence. (Ex: 12:30)</li> <li>3. Touch <b>CLOCK</b> pad again.</li> </ol> <div style="text-align: center;"> <div style="border: 1px solid black; padding: 2px; display: inline-block; margin: 2px;">CLOCK</div>  <div style="display: flex; justify-content: center; gap: 10px;"> <div style="border: 1px solid black; padding: 2px; display: inline-block;">1</div> <div style="border: 1px solid black; padding: 2px; display: inline-block;">2</div> <div style="border: 1px solid black; padding: 2px; display: inline-block;">3</div> <div style="border: 1px solid black; padding: 2px; display: inline-block;">0</div> </div>  <div style="border: 1px solid black; padding: 2px; display: inline-block; margin: 2px;">CLOCK</div> </div>	<p><b>MANUAL OPERATION</b></p> <p><b>High Power Cooking</b></p> <ol style="list-style-type: none"> <li>1. Enter cooking time by touching numbers pads. (Ex: 1 min. 30 sec.)</li> <li>2. Touch <b>START/TOUCH ON</b> pad.</li> </ol> <div style="text-align: center;"> <div style="border: 1px solid black; padding: 2px; display: inline-block; margin: 2px;">1</div> <div style="border: 1px solid black; padding: 2px; display: inline-block; margin: 2px;">3</div> <div style="border: 1px solid black; padding: 2px; display: inline-block; margin: 2px;">0</div>  <div style="border: 1px solid black; padding: 2px; display: inline-block; margin: 2px;">START</div>  <div style="border: 1px solid black; padding: 2px; display: inline-block; margin: 2px;">TOUCH ON</div> </div> <p><b>Variable Power Cooking</b></p> <ol style="list-style-type: none"> <li>2. After Step 1 above, touch <b>POWER LEVEL</b> pad.</li> <li>3. Select power level (Ex: 5 for 50%) and touch <b>START/TOUCH ON</b> pad.</li> </ol> <div style="text-align: center;"> <div style="border: 1px solid black; padding: 2px; display: inline-block; margin: 2px;">POWER</div> <div style="border: 1px solid black; padding: 2px; display: inline-block; margin: 2px;">LEVEL</div> <div style="border: 1px solid black; padding: 2px; display: inline-block; margin: 2px;">5</div>  <div style="border: 1px solid black; padding: 2px; display: inline-block; margin: 2px;">START</div>  <div style="border: 1px solid black; padding: 2px; display: inline-block; margin: 2px;">TOUCH ON</div> </div>
<p><b>INSTANT SENSOR POPCORN</b></p> <p>Touch <b>POPCORN</b> pad. Touch once for regular size and twice for snack size. See page 15.</p> <div style="text-align: center;"> <div style="border: 1px solid black; padding: 2px; display: inline-block; margin: 2px;">POPCORN</div> </div>	<p><b>MINUTE PLUS</b></p> <p>Touch <b>MINUTE PLUS</b> for one minute at 100% power or to add additional minutes.</p> <div style="text-align: center;"> <div style="border: 1px solid black; padding: 2px; display: inline-block; margin: 2px;">MINUTE</div>  <div style="border: 1px solid black; padding: 2px; display: inline-block; margin: 2px;">PLUS</div> </div>
<p><b>INSTANT SENSOR REHEAT</b></p> <p>Touch <b>SENSOR REHEAT</b> once. The oven will start automatically. <b>SENSOR REHEAT</b> can be programmed with turntable on or off. See Instant Sensor Chart on page 15.</p> <div style="text-align: center;"> <div style="border: 1px solid black; padding: 2px; display: inline-block; margin: 2px;">SENSOR</div>  <div style="border: 1px solid black; padding: 2px; display: inline-block; margin: 2px;">REHEAT</div> </div>	<p><b>TOUCH ON</b></p> <p>Continuously touch <b>START/TOUCH ON</b> for 100% power cooking. Remove finger and oven will stop instantly.</p> <div style="text-align: center;"> <div style="border: 1px solid black; padding: 2px; display: inline-block; margin: 2px;">START</div>  <div style="border: 1px solid black; padding: 2px; display: inline-block; margin: 2px;">TOUCH ON</div> </div>
<p><b>SENSOR COOK</b></p> <ol style="list-style-type: none"> <li>1. Touch <b>SENSOR COOK</b> pad.</li> <li>2. Select desired <b>SENSOR COOK</b> setting. (Ex: <b>1</b>)</li> <li>3. Touch <b>START/TOUCH ON</b> pad.</li> </ol> <p>See Sensor Cook Chart, page 16.</p> <div style="text-align: center;"> <div style="border: 1px solid black; padding: 2px; display: inline-block; margin: 2px;">SENSOR</div>  <div style="border: 1px solid black; padding: 2px; display: inline-block; margin: 2px;">COOK</div>  <div style="border: 1px solid black; padding: 2px; display: inline-block; margin: 2px;">1</div>  <div style="border: 1px solid black; padding: 2px; display: inline-block; margin: 2px;">START</div>  <div style="border: 1px solid black; padding: 2px; display: inline-block; margin: 2px;">TOUCH ON</div> </div>	<p><b>COMPU DEFROST</b></p> <ol style="list-style-type: none"> <li>1. Touch <b>COMPU DEFROST</b> pad (Ex: three times for a steak).</li> <li>2. Enter weight by touching number pad. (Ex: <b>2</b> and <b>0</b>.)</li> <li>3. Touch <b>START/TOUCH ON</b> pad.</li> </ol> <p>During defrosting, oven will stop. Check food. See CompuDefrost Chart on page 13.</p> <div style="text-align: center;"> <div style="border: 1px solid black; padding: 2px; display: inline-block; margin: 2px;">COMPU</div>  <div style="border: 1px solid black; padding: 2px; display: inline-block; margin: 2px;">DEFROST</div>  <div style="border: 1px solid black; padding: 2px; display: inline-block; margin: 2px;">2</div> <div style="border: 1px solid black; padding: 2px; display: inline-block; margin: 2px;">0</div>  <div style="border: 1px solid black; padding: 2px; display: inline-block; margin: 2px;">START</div>  <div style="border: 1px solid black; padding: 2px; display: inline-block; margin: 2px;">TOUCH ON</div> </div>
<p><b>TO PREHEAT AND COOK WITH CONVECTION</b></p> <ol style="list-style-type: none"> <li>1. Touch <b>PREHEAT</b> pad.</li> <li>2. Touch number pad for desired temperature. (Ex: touch pad <b>6</b> for 350° F.)</li> <li>3. Touch <b>CONVEC</b> pad.</li> <li>4. Touch number pad for desired temperature. (Ex: <b>5</b> for 325°F.)</li> <li>5. Enter cooking time by touching number pads. (Ex: <b>2</b><b>0</b><b>0</b><b>0</b>.)</li> <li>6. Touch <b>START/TOUCH ON</b> pad.</li> </ol> <div style="text-align: center;"> <div style="border: 1px solid black; padding: 2px; display: inline-block; margin: 2px;">SELECT</div> <div style="border: 1px solid black; padding: 2px; display: inline-block; margin: 2px;">PREHEAT</div>  <div style="border: 1px solid black; padding: 2px; display: inline-block; margin: 2px;">TEMP</div>  <div style="border: 1px solid black; padding: 2px; display: inline-block; margin: 2px;">350F</div> <div style="border: 1px solid black; padding: 2px; display: inline-block; margin: 2px;">PRESS</div>  <div style="border: 1px solid black; padding: 2px; display: inline-block; margin: 2px;">START</div> <div style="border: 1px solid black; padding: 2px; display: inline-block; margin: 2px;">OR</div>  <div style="border: 1px solid black; padding: 2px; display: inline-block; margin: 2px;">PRESS</div> <div style="border: 1px solid black; padding: 2px; display: inline-block; margin: 2px;">CONVEC</div>  <div style="border: 1px solid black; padding: 2px; display: inline-block; margin: 2px;">SELECT</div> <div style="border: 1px solid black; padding: 2px; display: inline-block; margin: 2px;">TEMP</div>  <div style="border: 1px solid black; padding: 2px; display: inline-block; margin: 2px;">325F</div>  <div style="border: 1px solid black; padding: 2px; display: inline-block; margin: 2px;">ENTER</div> <div style="border: 1px solid black; padding: 2px; display: inline-block; margin: 2px;">COOKING</div>  <div style="border: 1px solid black; padding: 2px; display: inline-block; margin: 2px;">TIME</div>  <div style="border: 1px solid black; padding: 2px; display: inline-block; margin: 2px;">20.00</div> <div style="border: 1px solid black; padding: 2px; display: inline-block; margin: 2px;">PRESS</div>  <div style="border: 1px solid black; padding: 2px; display: inline-block; margin: 2px;">START</div>  <div style="border: 1px solid black; padding: 2px; display: inline-block; margin: 2px;">PREHEAT</div> </div> <p>When the oven reaches the programmed temp., it will automatically hold at the preheat temperature for 30 minutes and then the display will change to the time of day. Whenever <b>STOP/CLEAR</b> is touched during this 30 minute period, <b>PRESS CONVEC</b> or <b>PRESS MIX</b> will be displayed and cooking mode and time can be entered.</p> <p>For more information on convection cooking, see pages 19 and 20.</p>	<p><b>COMPU ROAST</b></p> <p>or CompuBake or CompuBroil</p> <ol style="list-style-type: none"> <li>1. Touch desired <b>COMPU</b> pad.</li> <li>2. Select desired Compu setting. (Ex: Touch <b>1</b> for chicken.)</li> <li>3. Touch number pad for weight or quantity.</li> <li>4. Touch <b>START/TOUCH ON</b> pad.</li> </ol> <p>See CompuRoast, Bake and Broil Charts on pages 21, 22 and 23.</p> <div style="text-align: center;"> <div style="border: 1px solid black; padding: 2px; display: inline-block; margin: 2px;">COMPU</div>  <div style="border: 1px solid black; padding: 2px; display: inline-block; margin: 2px;">ROAST</div>  <div style="border: 1px solid black; padding: 2px; display: inline-block; margin: 2px;">1</div>  <div style="border: 1px solid black; padding: 2px; display: inline-block; margin: 2px;">2</div> <div style="border: 1px solid black; padding: 2px; display: inline-block; margin: 2px;">5</div>  <div style="border: 1px solid black; padding: 2px; display: inline-block; margin: 2px;">START</div>  <div style="border: 1px solid black; padding: 2px; display: inline-block; margin: 2px;">TOUCH ON</div> </div>
<p><b>TO COOK WITH AUTOMATIC MIX</b></p> <p>Touch <b>LOW MIX/BAKE</b> pad, enter desired cooking time and touch <b>START/TOUCH ON</b> pad. Follow information on the display.</p> <div style="text-align: center;"> <div style="border: 1px solid black; padding: 2px; display: inline-block; margin: 2px;">325F</div> <div style="border: 1px solid black; padding: 2px; display: inline-block; margin: 2px;">ENTER</div>  <div style="border: 1px solid black; padding: 2px; display: inline-block; margin: 2px;">COOKING</div> <div style="border: 1px solid black; padding: 2px; display: inline-block; margin: 2px;">TIME</div>  <div style="border: 1px solid black; padding: 2px; display: inline-block; margin: 2px;">PRESS</div> <div style="border: 1px solid black; padding: 2px; display: inline-block; margin: 2px;">START</div> </div> <p>Your oven can be programmed to combine preheating and automatic mix cooking operations. See page 19 for information.</p>	<div style="text-align: center;"> <h1 style="margin: 0;">SHARP</h1> <p style="margin: 0;">SHARP ELECTRONICS CORPORATION Sharp Plaza, Mahwah, NJ 07430-2135</p> </div> <div style="text-align: right; margin-top: 10px;"> <p style="font-size: 8px; margin: 0;">RECYCLED PAPER PRINTED IN USA</p> </div>

Carousel® is a registered trademark of Sharp Corporation.

## 4-14-14 Gas Refrigerator

The standard refrigerator for the 450 LXi is a 13.5 cu. ft. Dometic SideWise Refrigerator.

### 4-14-14.1 Exterior

This refrigerator from the outside makes a statement of being non-RV. The full silver and black stainless doors will make a real statement in most galley layouts. The full-length door handle system provides a customer-friendly means for unlocking the doors.

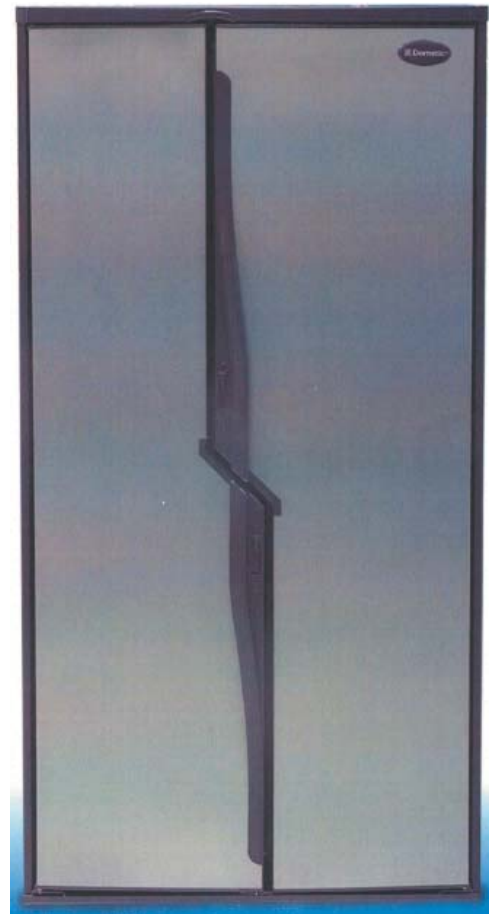
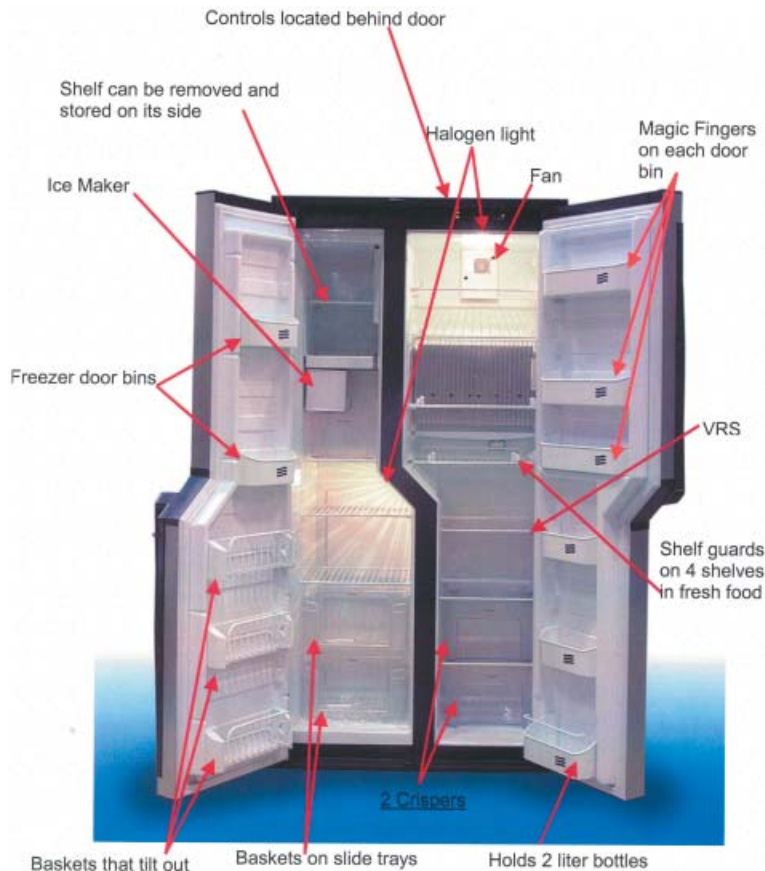

### 4-14.14.2 Fresh Food Side

- Control package is located behind the door. Once the refrigerator is turned on and the temperature is set, there is no reason to have it exposed.
- The control package makes the SideWise look very residential.

- Halogen light provides great light intensity throughout the interior.
- A brushless fan designed to run continually when the refrigerator is on providing even temperature from top to bottom even when there isn't any space between items on each shelf.
- VRS enables the consumer to move 3 of the shelves in one-inch increments providing the best space utilization.
- The second shelf folds back against the evaporator to provide height for very tall items.
- One slide-out shelf makes it easier to remove a large heavy pan standing straight up compared to bending your back.
- Different width shelves will provide better utilization of the available space.
- Shelf guards allow items to be blocked from falling over or off the shelf when opening the door. When you need an item, just lift up on the shelf guard bar and drop it down. As items are removed from the shelf, simply keep pushing the shelf guard back to secure items in place.
- Two large clear view slide-out crispers just like you may have at home, for fresh produce and meats.
- Space for 2-liter bottles. The lower door bin will hold any 2-liter bottle and has a retainer bar for tall slender containers.
- Magic fingers - each door shelf has one set so smaller items can be wedged in securely.

### 4-14.14.3 Freezer Section

- The freezer section offers 58% more than ever before.
- The top shelf can be removed and stored on the side to provide space for tall items in the upper section of the freezer.
- Optional ice maker.
- Halogen light illuminates the area. Never before has there been an absorption refrigerator with a light in the freezer.
- Three wire bins that tilt out. This allows for full use of the space between the bins.
- Two additional door bins to house smaller items.
- Two clear view baskets with individual side tracks. This provides the ease of loading and removing items without complete removal of the heavy baskets when full.



### 4-14.14.3 Refrigerator Control Panel

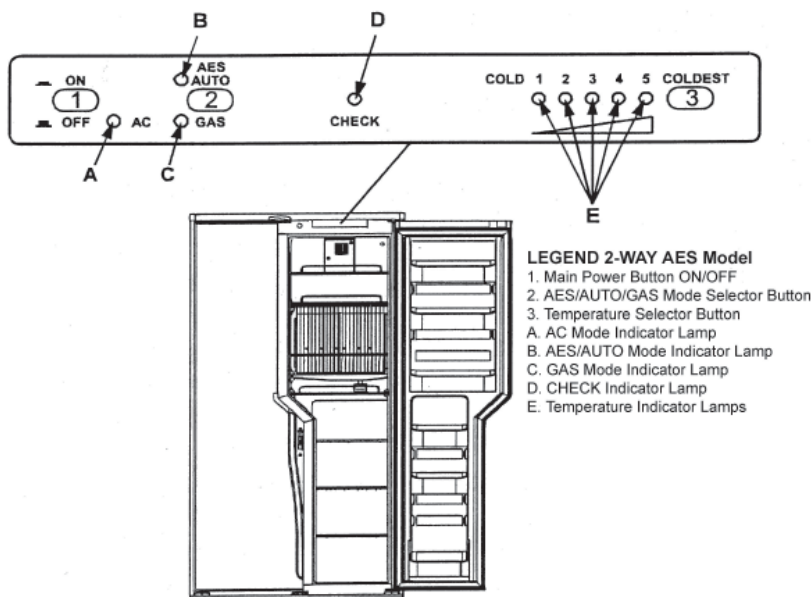

### 4-14.14.4 Operating Instructions

#### IMPORTANCE OF LEVELING A REFRIGERATOR

In an absorption refrigerator system, ammonia is liquefied in the finned condenser coil at the top rear of the refrigerator. The liquid ammonia then flows into the evaporator (inside the freezer section) and is exposed to a circulating flow of hydrogen gas, which causes the ammonia to evaporate, creating a cold condition in the freezer.

When starting this refrigerator for the very first time, the cooling cycle may require up to four hours of running time before the cooling unit is fully operational.

The tubing in the evaporator section is specifically sloped to provide a continuous movement of liquid ammonia, flowing downward by gravity through this section. If the refrigerator is operated when it is not level and the coach is not moving, liquid ammonia will accumulate in sections of the evaporator tubing. This will slow the circulation of hydrogen and ammonia gas, or in severe cases, completely block it, resulting in a loss of cooling.

Any time the coach is parked for several hours with the refrigerator operating, the coach should be leveled to prevent this loss of cooling. The coach needs to be leveled only so it is comfortable to live in (no noticeable sloping of floor or walls).

When the coach is moving, the leveling is not critical, as the rolling and pitching movement of the coach will pass to either side of level, keeping the liquid ammonia from accumulating in the evaporator tubing.

#### OPERATION

Before starting the refrigerator, check that all the manual gas valves are in the ON position. DO NOT forget the manual shutoff valve on the rear of the refrigerator (see Fig. 1).

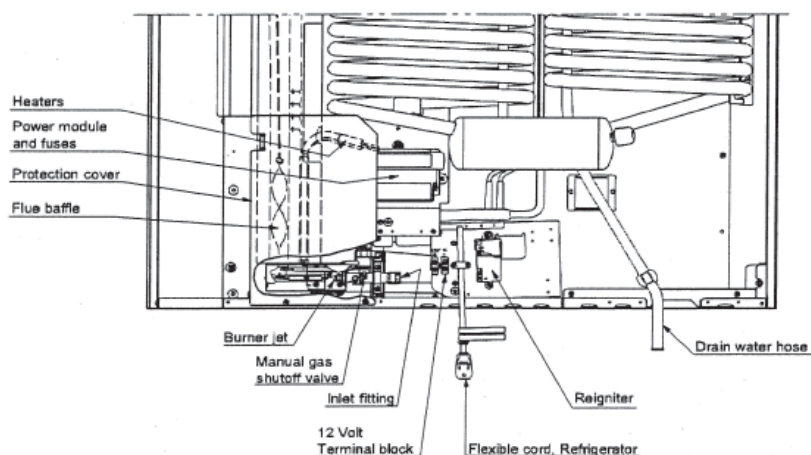

This refrigerator is equipped with an Automatic Energy Selector (AES) control system, which can automatically select the most suitable energy source which is available, either 120 Volt AC, or LP gas operation. The system can be set by the user to be fully automatic, or if desired, LP gas only. The refrigerator controls will work down to 9.6 volt DC.

### WARNING!!

Most LP gas appliances used in recreational coaches are vented to the outside of the coach. When parked close to a gasoline pump, it is possible that the gasoline fumes could enter this type of appliance and ignite from the burner frame, CAUSING A FIRE OR AN EXPLOSION.

FOR YOUR SAFETY, when refueling, shut off all LP gas appliances which are vented to the outside.

## 4-14.14.5 Start Up Instructions

- A continuous 12 volt DC supply must be available for the electronic control to function.
- Press the main power ON/OFF button (1) to the DOWN position.
- Press the TEMPERATURE SELECTOR button (3) until the lamp at the desired setting is illuminated.

### AES/AUTO MODE

- Press the AES/AUTO/GAS mode selector button (2) to turn ON the AES/AUTO lamp (B). If 120 volts is available, the AC mode indicator lamp (A) will illuminate indicating AC operation. If 120 volts AC is not available, the GAS indicator lamp (C) will illuminate indicating the control has automatically switched to the GAS mode.
- If the CHECK indicator lamp (D) illuminates and the GAS mode indicator lamp (C) is off, the controls have failed to ignite the burner in the GAS mode. GAS operation may be reset by pressing the main power ON/OFF button (1) to the OFF then ON position. (See step 2 under GAS MODE).
- Press the TEMPERATURE SELECTOR button (3) until the lamp at the desired position is illuminated.

### GAS MODE

- Press the AES/AUTO/GAS mode selector button (2) to turn OFF the AES/AUTO lamp (B). The GAS mode indicator lamp (C) will illuminate. Within 45 seconds the burner should be ignited and operating normally.
- On the initial refrigerator start-up, it may take longer than 45 seconds to allow air to be purged from the gas line. If the gas does not ignite within 45 seconds the CHECK indicator lamp (D) will illuminate and the GAS mode indicator lamp (C) will go off.

To reset when the CHECK indicator lamp (D) is illuminated, press the main power ON/OFF button (1) to the OFF and then ON position.



**NOTE:** Do not continue to reset GAS operation if the CHECK indicator lamp continues to be illuminated after several tries.

- Press the TEMPERATURE SELECTOR button (3) until the lamp at the desired position is illuminated.



## THERMOSTAT

The thermostat on the refrigerator controls both the gas and electric operation, thereby eliminating the necessity of resetting each time a different energy source is employed.

After the initial start-up, the thermostat should be moved from “COLDEST” to the desired temperature setting, usually at mid setting.

## TO SHUT OFF THE REFRIGERATOR

The refrigerator may be shut off while in any mode of operation by pressing the main power ON/OFF button to the UP (OFF) position. This shuts off all DC power to the refrigerator, including the interior light.

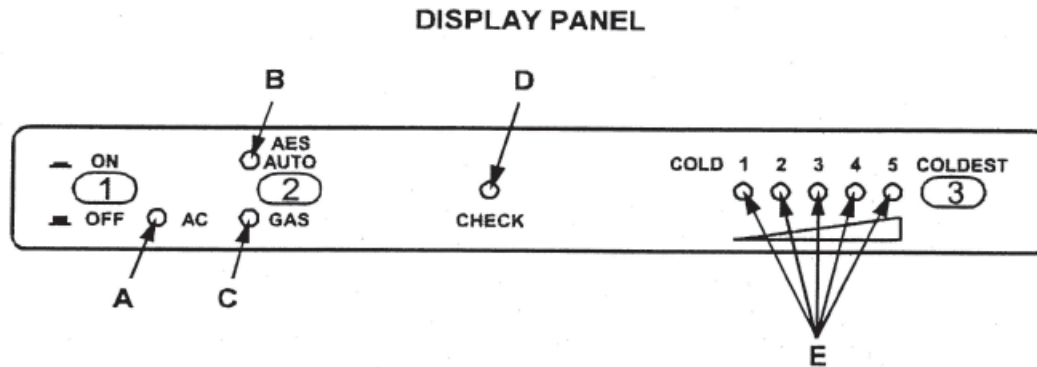

### 4-14.14.6 Start Up Instructions

- A continuous 12 volt DC supply must be available for the electronic control to function.
- Press the main power ON/OFF button (1) to the DOWN position.
- Press the TEMPERATURE SELECTOR button (3) until the lamp at the desired setting is illuminated.

### AES/AUTO MODE

- Press the AES/AUTO/GAS mode selector button (2) to turn ON the AES/AUTO lamp (B). If 120 volts is available, the AC mode indicator lamp (A) will illuminate indicating AC operation. If 120 volts AC is not available, the GAS indicator lamp (C) will illuminate indicating the control has automatically switched to the GAS mode.
- If the CHECK indicator lamp (D) illuminates and the GAS mode indicator lamp (C) is off, the controls have failed to ignite the burner in the GAS mode. GAS operation may be reset by pressing the main power ON/OFF button (1) to the OFF then ON position. ([See step 2 under GAS MODE](#)).
- Press the TEMPERATURE SELECTOR button (3) until the lamp at the desired position is illuminated.

### GAS MODE

- Press the AES/AUTO/GAS mode selector button (2) to turn OFF the AES/AUTO lamp (B). The GAS mode indicator lamp (C) will illuminate. Within 45 seconds the burner should be ignited and operating normally.
- On the initial refrigerator start-up, it may take longer than 45 seconds to allow air to be purged from the gas line. If the gas does not ignite within 45 seconds the CHECK indicator lamp (D) will illuminate and the GAS mode indicator lamp (C) will go off.

To reset when the CHECK indicator lamp (D) is illuminated, press the main power ON/OFF button (1) to the OFF and then ON position.

**NOTE:** Do not continue to reset GAS operation if the CHECK indicator lamp continues to be illuminated after several tries.

Press the TEMPERATURE SELECTOR button (3) until the lamp at the desired position is illuminated.

## THERMOSTAT

The thermostat on the refrigerator controls both the gas and electric operation, thereby eliminating the necessity of resetting each time a different energy source is employed.

After the initial start-up, the thermostat should be moved from “COLDEST” to the desired temperature setting, usually at mid setting.

## 4-14.14.7 Description of Operating Modes

### AES/AUTO MODE

When operating in the AES/AUTO mode, the AES/AUTO mode indicator lamp (B) will illuminate. The control system will automatically select between AC and GAS operation with AC having priority over GAS. Either the AC indicator lamp (A) or the GAS indicator lamp (C) will illuminate depending on the energy source selected by the control system. If the control system is operating with AC energy and it then becomes unavailable, the system will automatically switch to GAS. As soon as AC becomes available again the control will switch back to AC regardless of the status of GAS operation. Refer to Display Panel found previously for illustration.

### GAS MODE

When operating in the GAS mode the AES/AUTO mode indicator lamp (B) will be off and the GAS mode indicator lamp (C) will be illuminated. This mode provides LP gas operation only. The control system will activate the ignition system and will make three attempts to light the burner for a period of approximately 45 seconds with two minute intervals. If unsuccessful, the CHECK indicator lamp (D) will illuminate and the GAS mode indicator lamp (C) will turn off.

To restart GAS operation, press the main power ON/OFF button (1) to the OFF and then ON position. The control system will attempt a new ignition sequence.

If the refrigerator has not been used for a long time or the LP tanks have just been refilled, air may be trapped in the supply lines. To purge the air from the lines may require resetting the main power ON/OFF button (1) three or four times. If repeated attempts fail to start the LP gas operation, check to make sure that the LP gas supply tanks are not empty and all manual shutoff valves in the lines are open. If the problem is still not corrected, contact a service center for assistance.

If the control is switched to AC operation while the CHECK indicator lamp is on, it will function properly, but the CHECK indicator lamp will not go off until the main power ON/OFF button is pressed to the OFF then ON position.

### LIMP MODE OF OPERATION

This control system contains a feature where it will continue to operate the cooling system in the event of a failure of a major operating component. Two different modes of operation can occur in this category.

If for some reason the display module becomes non functional, the control system will revert to full automatic operation selecting the best energy source available with AC, Gas priority. The temperature of the refrigerator will be maintained at the MID position within normal temperature tolerances. The power module will continually attempt to reestablish operation of the display module.

The second limp mode of operation will execute when a failure of the temperature sensing device or associated electronic circuitry occurs. If this should occur, the control system will operate on the energy source selected via the control panel. The cooling unit will run continuously on the selected energy source. The refrigerator will continue to operate in this module indefinitely or until a new sensor is installed and the system is reset.

## 4-14.14.8 How to Use the Refrigerator

### FOOD STORAGE COMPARTMENT

The food storage compartment is completely closed and unventilated, which is necessary to maintain the required low temperature for food storage. Consequently, foods having a strong odor or those that absorb odors easily should be covered. Vegetables, salads etc. should be covered to retain their crispness. The coldest positions in the refrigerator are under the cooling fins and at the bottom of the refrigerator. The warmer areas are on the upper door shelves. This should be considered when placing different types of food in the refrigerator.

When the refrigerator is heavily loaded, it will take a longer time to lower the temperature; therefore, to get maximum efficiency the refrigerator and food items should be pre-cooled prior to loading. The shelves should not be covered with paper or plastic, and the food items should be arranged so air can circulate freely.

If you need more space in the refrigerator you can lift up the front of the second shelf from the top and push the shelf in, the shelf will fall down against the finned evaporator. This shelf cannot be relocated to a different position within the refrigerator.

The middle shelf is a sliding shelf, to slide out grasp the front of the shelf and pull forward. Push the shelf in to return to original position. This shelf cannot be relocated to a different position within the refrigerator.

The lower door shelf is designed for large containers or bottles (1/2-gallon milk or juice).

## FROZEN FOOD STORAGE COMPARTMENT

Quick frozen soft fruits and ice cream should be placed in the coldest part of the compartment, which is on the top freezer shelf. Frozen vegetables, may be stored in any part of the compartment.

This compartment is not designed for deep or quick-freezing of food. Meat or fish, whether raw or prepared, can be stored in the frozen food storage compartment provided they are pre-cooled first in the refrigerator. They can be stored about three times longer in the frozen food compartment as compared to the fresh food compartment. To prevent food from drying out, keep it in covered dishes, containers, plastic bags or wrapped in aluminum foil.

Total Refrigerated Volume is 13.2 cu. ft.

## ICE MAKING

Ice cubes can be made in ice trays placed in the freezer compartment. For faster ice making, the trays should be placed in direct contact with the aluminum shelf.

Ice will be made more rapidly if the thermostat is set at its highest position. It is a good idea to do this a few hours before the anticipated need for ice, but be sure to move the thermostat back to normal setting, usually about mid setting when the ice is formed. Food in the fresh food compartment may be frozen if the setting is left on "COLDEST" position for too long.

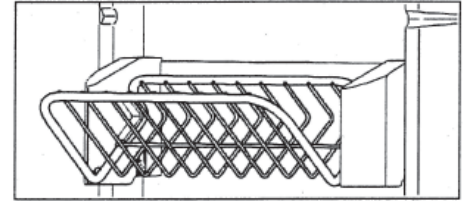

## FREEZER DOOR

The freezer door has three wire door baskets for frozen food items, such as bagged vegetables.

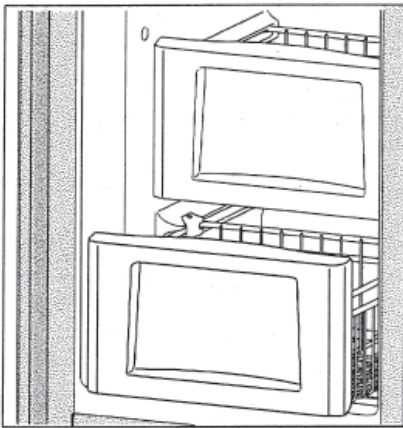

## FREEZER COMPARTMENT

The freezer compartment has two sliding wire baskets for more convenient access to the frozen foods.

## DEFROSTING

Shut off the refrigerator by pressing the main power ON/OFF button to the UP (OFF) position.

Empty the refrigerator, leaving the drip tray under the finned evaporator, and the cabinet and freezer doors open. Filling ice trays with hot water and placing them on the freezer shelves can reduce defrosting time.

When all the frost has melted, dry the interior of the refrigerator and freezer with a clean cloth. Replace all food and set the thermostat to the COLDEST temperature setting for a few hours. Then reset the thermostat to the desired setting, usually at mid setting.

### CAUTION!!

Do not use a hot air blower. Permanent damage could result from warping the metal or plastic parts. DO NOT use a knife or an ice pick, or other sharp tools to remove frost from the freezer shelves. They can create a leak in the ammonia system.

## CLEANING

Cleaning the refrigerator is usually done after it is defrosted or put into storage. To clean the interior liner of the refrigerator, use lukewarm weak soda solution. Use only warm water to clean the finned evaporator, ice trays and shelves. NEVER use strong chemicals or abrasives to clean these parts, as the protective surfaces will be damaged. It is important to always keep the refrigerator clean.

## SHUT OFF - STORAGE PROCEDURE

Shut off the refrigerator by pressing the main power ON/OFF button to the UP (OFF) position.

If the refrigerator will not be in operation for a period of weeks, it should be emptied, defrosted, cleaned and the doors left ajar. The ice trays should also be dried and kept outside the cabinet.

### WARNING!!

DO NOT store explosive substances in the refrigerator, such as cigarette lighter gas, gasoline, ether or the like.



**NOTE:** Sodium chromate is used for corrosion protection (less than 2-weight % of the coolant).

## 4-14.14.9 Electric Equipment

### HEATERS

The heat necessary for the operation of an absorption cooling unit is supplied by an electric heater mounted in a pocket of the boiler system.

This model is equipped with a series connected twin heater.

#### **To replace the heater proceed as follows:**

1. Disconnect the wall plug, and the 12 volt wires.
2. Remove the protection cover.
3. Remove the power module cover.
4. Disconnect the heater leads.
5. With a pair of pliers unfold the lug holding the lid of the boiler casing and open the lid.
6. Remove some insulation wool so that the heater is accessible.
7. Turn and lift the heater out of its pocket.
8. Fit the new heater into the pocket.
9. Connect the leads and put on the power module cover.
10. Reset the insulation and close the lid of the boiler.
11. Replace the protection cover.

### FUSES

This model is equipped with 2 fuses, one for the refrigerator control system and one for AC cartridge heater. (see table below).

To replace fuses proceed as follows:

1. Disconnect the wall plug, and the 12 volt wires.
2. Remove the power module cover. ([see Fig. 1](#))
3. Snap the fuse out of the fuse holder.
4. Fit a new fuse in to the fuse holder.
5. Replace the power module cover.

Control System	3 Amp
AC Heater	5 Amp

## 4-14.14.10 Maintenance and Service

The user should be aware of service that must be done on a regular schedule to keep the refrigerator operating properly. The service should only be performed by qualified technicians who are familiar with LP gas systems and refrigerators.

### REFRIGERATOR REMOVAL

Before working on the refrigerator, make sure the AC voltage and DC voltage leads are disconnected. Shut off the gas supply. Disconnect the gas supply line at the rear of the refrigerator ([see Fig. 1](#)). Always use a back up wrench when loosening and tightening this connection. Cap the gas supply line loosen the screws anchoring the refrigerator to the enclosure and slide the refrigerator out of the compartment.

When replacing the refrigerator make sure that the sealing strips are properly positioned.

Replacement is the reverse of removal. Check all connections for gas leaks.

### PERIODIC MAINTENANCE

To keep your Dometic refrigerator operating efficiently and safely, periodic inspection and cleaning of several components once or twice a year is recommended.

- A. It is important to keep the area at the back of the refrigerator clean. Check the lower vent, upper vent and area between these openings for any obstructions such as bird/insect nests, spider webs, etc. Clean the coils on the back of the refrigerator. Use a soft bristled brush to dust off the coils.

It is important to keep the refrigerator area free from combustible material, gasoline and other flammable vapors or liquids.

## GAS EQUIPMENT ASSEMBLY

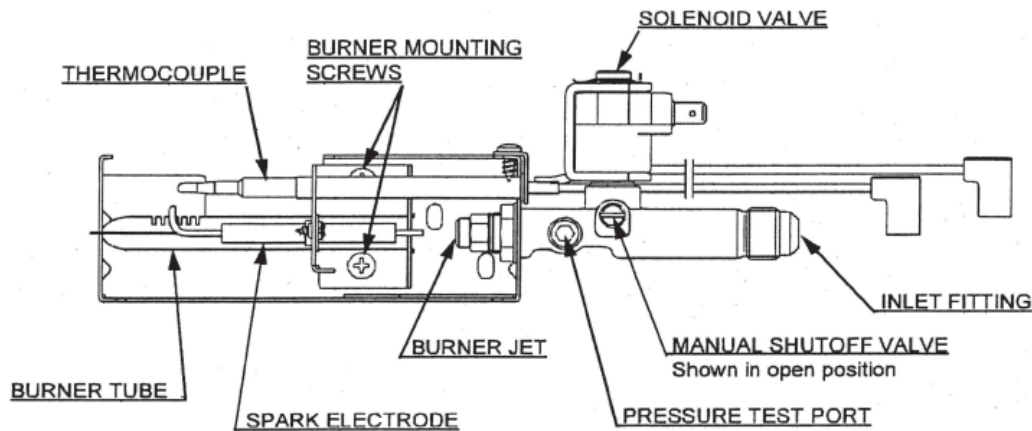

**NOTE:** The following maintenance is required once or twice a year, but should only be done by a qualified serviceman who is familiar with LP gas systems and refrigerators.

Check all connections in the LP gas system (at the back of the refrigerator) for gas leaks. The LP gas supply must be turned on. Apply a non-corrosive bubble solution to all LP gas connections. The appearance of bubbles indicates a leak and should be repaired immediately by a QUALIFIED SERVICE PERSON WHO IS FAMILIAR WITH GAS SYSTEMS AND REFRIGERATORS.

**WARNING!!** DO NOT use a flame to check for gas leaks.

- C. Check the AES control system by connecting/disconnecting 120 volt AC power, start/stop the engine, etc. Compare the operation with the operation described in description of operating modes.
- D. The LP gas pressure should be checked and the main regulator readjusted if pressure is incorrect. The correct operating pressure is 11 inches of water column. The correct place to take the LP gas pressure is at the test port just ahead of the burner jet.
- E. Inspect the fuel baffle. It should be reasonably clean and free of soot. Heavy soot formation indicates improper functioning of the burner. The flue and burner both require cleaning in the following manner.
  1. Unplug the refrigerator power cord from the 120 volt AC outlet.
  2. Disconnect or shut off the 12 volt power to the refrigerator.
  3. Turn manual shutoff valve to OFF. (see Fig. 1).
  4. Remove cover from the burner housing. (See Fig. 1).
  5. Disconnect the wire from the high voltage electrode.
  6. Remove the burner mounting screws and remove the burner assembly.
  7. Remove the wire and the flue baffle from the top of flue tube. Clean the flue tube from the top using a flue brush. Blowing compressed air into the flue will not properly clean soot and scale out of the flue tube. Replace the flue baffle.
  8. Clean burner tube with a brush. Blow out burner with compressed air.
  9. Before removing burner jet, clean burner area of soot and scale that fell out of flue tube. Remove the burner jet. Soak the jet in wood alcohol and blow it out with compressed air. Reinstall and tighten burner jet.

**NOTE:** The color of the flame shall be clear blue over the slots of the burner. (See figure at right.)

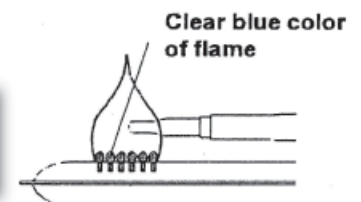

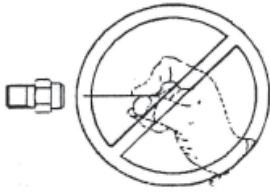
**WARNING!!**

**DO NOT use a wire or pin when cleaning the burner jet as damage can occur to the precision opening. This can cause damage to the refrigerator or create a fire hazard.**

10. Reinstall burner, being careful that the end of the burner fits into the slot on the burner bracket. Check to make sure slots are centered under the flue tube and the thermocouple is positioned properly (tip of thermocouple extends over two slots of burner).
11. Be sure to reconnect the wire to high voltage electrode. Check the electrode for proper location and gap. (See figure at left)
12. Turn on manual gas shutoff valve and check all fittings for leaks.
13. Connect 120 volt power cord to the outlet and reconnect or turn on the 12 volt DC power.
14. Check LP gas safety shutoff.

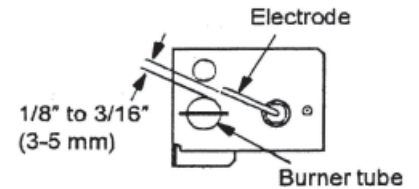
**REPLACING A HALOGEN LAMP****CAUTION!!**

Turn off the refrigerator before replacing the lamp. Wear gloves as protection against hot lamp, broken glass and as protection of the new lamp.

**Refrigerator**

The lamp is located at the top of the refrigerator compartment.

**To replace the lamp proceed as follows:**

1. Unhook the tab on the lamp cover by pressing in with the thumb on the side of the lamp cover.
2. Remove the lamp cover.
3. With gloves, pull out the lamp from the socket and replace it with a new 12V, 10-watt halogen lamp base G4.
4. Replace the lamp cover by placing the two tabs into the corresponding slots of the lamp house and press the tab into place.

**Freezer**

The lamp is located on the right side of the freezer compartment.

**To replace the lamp proceed as follows:**

1. Unhook the tab on the lamp cover by pressing in with the thumb on the side of the lamp cover.
2. Remove the lamp cover.
3. With gloves, pull out the lamp from the socket and replace it with a new 12V, 5-watt halogen lamp base G4.
4. Replace the lamp cover by placing the two tabs into the corresponding slots of the lamp house and press the tab into place.

## 4-14.14.11 Troubleshooting

### The Refrigerator Does Not Cool Properly

- A. Burner jet clogged. Clean. (See [Maintenance and Service](#) section, item 2, [Periodic Maintenance, Paragraph E, Item 1-14.](#))
- B. Check level of refrigerator.
- C. Venting problem. Restriction in air flow across cooling unit.
- D. Heavy frost buildup on evaporator fins. Defrost
- E. Flue baffle not inserted properly in flue tube.
- F. Improperly set thermostat. (See [Operating Instructions, part Start Up Instructions.](#))
- G. Burner dirty. Clean. (See [Maintenance and Service, Item 2, Periodic Maintenance, Paragraph E, Item 1-14.](#))
- H. LP Gas pressure low at burner. Set main regulator so pressure does not drop below 11 inches water column at pressure tap.
- I. Burner not located properly under flue tube. Relocate.
- J. Burner damaged. Replace.
- K. Odors from fumes.
  - 1. Dislocated burner.
  - 2. Damaged burner.
  - 3. Dirty flue tube.
- L. Fuses
  - 1. Refrigerator AC Supply.



**NOTE:** Avoid spraying water through the refrigerator vents while washing the coach.

All the above instructions are to be followed closely. The refrigerator is quality-guaranteed. However, we are not responsible for any failures caused by improper adjustments and unfavorable installation conditions. Contact service point or distributor service department for assistance.

## 4-14.15 Electric Refrigerator (Optional)

The KitchenAid® Stainless Steel w/Black 22.0 cu. ft. Superba® Side-by-Side Refrigerator with Thru-the-Door Ice and Water may be purchased as an alternative to the Dometic gas refrigerator that comes standard.

### 4-14.16.1 Features:

**Warranty:** 1 Year

**Capacity:** Freezer: 7.5 cu. ft.

**Capacity:** Fresh Food Volume: 14.5 cu. ft.

**Capacity:** Total Shelf Area: 22.0 sq. ft.

**Energy:** Kilowatt Hrs. per Year: 607

**Energy Star Compliant:** Yes

**Ice Maker:** Type: Ice maker, factory installed

**Thru-the-Door Dispenser:** Type: Ice and water

**Water Filtration:** Yes

**Fresh Food Shelves:** 3 adjustable Rollertrac™ plus Spillclean™ shelves  
3 adjustable Rollertrac™ plus Spillclean™ slide-out shelves

**Fresh Food Bins:** Egg Bin: Clearvue™ egg container

**Meat Keeper:** Freshchill™ convertible meat locker

**Special Items Bin:** Wine rack

**Vegetable Crisper:** Freshseal™ humidity-controlled vegetable crisper.

**Freezer Features:** 2 White Triple Tall Slide-Out Freezer Basket System 3 Freezer Shelves



*This chart explains some of the features that are standard with this refrigerator.*

Feature	Description	Benefit
Power Switch	Button that will turn on cooling and control display when it is pressed and held for 2 seconds.	Allows you to operate digital controls.
Max Cool	Button that simultaneously changes and overrides both the refrigerator and freezer temperature to a colder setting for 24 hours. After the 24 hour period, the refrigerator and freezer temp changes back to the previous temperature setting.	Maintains Freshness - cools refrigerated foods 30% faster and freezer foods 20% faster.
Water Filter Reset	Button that resets the Water Filter Indicator light to Green (Good Filter). You must hit reset after changing the filter.	Easier to reset - You no longer need to press the light switch 5 times within 10 seconds to reset.
Over Temp Reset	Button that turns off overtemp alarm which comes on when either the refrigerator or freezer temperature exceed 48°F or 15°F, respectively, for over 1.5 hours. The alarm will deactivate if the overtemp condition self-corrects but a light will continue to flash.	Peace of Mind - Alerts you to check food in the event of a power failure or an overtemp condition such as door ajar or system malfunction.
Numeric Temperature Display	Numeric Control can display temperature settings in Celsius and Fahrenheit degree units. The digital controls can adjust the refrigerator and freezer temperatures 2° up or down.	Customization - allows you to override the refrigerator and/or freezer temperature default settings.
ExtendFresh™ Temperature Management System	An Indicator light that is steadily lit when the Smart™ Fan runs.	Peace of Mind - You know that the ExtendFresh™ Temperature Management System is operating.



### 4-14.15.2 ExtendFresh™ Temperature Management System

Some benefits are:

- Keeps temperature within 1°F of setting.
- Independent temperature controls for both freezer and refrigerator components.
- Dual Sensors immediately identify changes in temperature, triggering the Smart™Fan
- Smart™Fan pulls air from the Freezer into the Refrigerator without turning on the compressor, saving energy.

### 4-14.15.3 AquaSense™ In-Door -Ice Dispensing System

KitchenAid® did independent research and found that the #1 dislike of customers was lack of freezer space and as a result of that research they have developed a system which moves the ice pitcher from the cabinet to the door, creating 19% more usable freezer space in 25 Cubic Feet refrigerators and 27% more in 22 Cubic Feet refrigerators. The AquaSense™ In-Door-Ice Dispensing System is an ideal companion to the AquaSense™ Ice and Water Filtration system and just as practical. The conveniently positioned ice maker makes it easy to access a fresh supply of ice when refilling ice buckets and blenders.



### 4-14.15.4 AquaSense™ Water Filtration System



The AquaSense™ Twice-The-Life™ ice and water filter offers 500 gallons of filtering to remove lead, chlorine, particles and turbidity. A monitor lighting system takes the guesswork out of when to change the filter: green-good filter, yellow-order filter, red-change filter. The up front grille location allows for a quick and easy filter change without the need to remove food from refrigerator shelf.

### 4-14.15.5 SpillClean™ RollerTrac™ Adjustable Glass Shelves

SpillClean™ Glass Shelves have raised edges to keep spills in place for fast and easy cleaning - which keeps your refrigerator looking like new. KitchenAid® door shelves, crisper and meat pan drawers, and the roll-out freezer floor all feature the Roller Trac™ Plus system. Rollers allow the shelves, drawers and floors to glide out smoothly and quietly for easier reach of stored items. Roll-out shelves sustain up to 60 pounds even when fully loaded and the freezer floor holds up to 75 pounds.

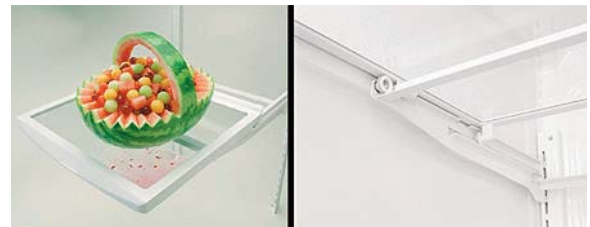

### 4-14.15.6 FreshChill™ Temperature Controlled Convertible Vegetable/Meat Locker

The major benefit of the FreshChill™ Locker is how it lets you properly store expensive prepared meat in a compartment that is colder than the rest of the refrigerator to help preserve freshness. The FreshChill™ temperature-controlled meat locker maintains a temperature range of 28-32 degrees F inside the meat locker without affecting the rest of the refrigerator. Top-to-bottom See Through Fresh Seal Crisper and Fresh Chill Meat Locker are engineered for freshness. The humidity-controlled crisper is sealed with gaskets on all four sides and the meat locker is temperature-controlled. For added convenience, the meat locker converts to a crisper.



### 4-14.15.7 Slide N Lock™ Door Storage System

Slide N Lock™ Door Bins and Can Racks offer unparalleled flexibility and convenient refrigerator door storage. All can racks and door bins carry a lifetime warranty. KitchenAid® four-sided adjustable door bins are sturdy enough to lift out even when fully loaded. The unique, laddered system lets you adjust the bins up and down to fit your storage needs. The Gallon Door Storage Bin allows you to free up shelf space by storing gallon containers in the door. It's ergonomic position at the bottom of the door allows you to easily lift them out and replace them. The gallon bin is removable for easy cleaning.

### 4-14.15.8 FreshSeal™ Dairy Locker System

The FreshSeal™ Dairy Locker System is transparent for easy viewing and slides up smoothly for loading and unloading. A gasket along the front of the cover presents air from entering and seals in freshness. Many KitchenAid® Refrigerators includes a high quality, Pyrex glass butter dish for convenience.



### 4-14.15.9 FreshSeal™ Humidity-Controlled Crispers

KitchenAid® ClearVue™ humidity-controlled crispers provide more flexible storage and preservation for your fruits and vegetables than ever before. The crispers are clear for easy viewing and the seal at the front of the crisper locks in the humidity that is needed to keep leafy vegetables crisp and fresh. KitchenAid® crispers are sealed on all four sides with gaskets to prevent colder air from escaping while maintaining the freshness of fruits and vegetables longer. The seal provides over 80% humidity retention, optimizing storage of fruits and leafy vegetables. Controls are easy to read and can be quickly adjusted to set the desired crisper temperature. Air flows in through the vents located along the front of the crisper. The placement of the vents prevent any spills in the refrigerator from leaking into the crisper when they are open.

### 4-14.15.10 Cleaning

Cleaning of this refrigerator is much like that of a house refrigerator. Use warm soapy water for tough stains. Do not use abrasive cleansers as they may scratch the surface of the refrigerator.

## 4-14.16 In-Sink-Erator

### 4-14.16.1 Instant Hot Water Dispenser

Your coach is equipped with an In-Sink-Erator Instant Hot Water Dispenser. This will give you hot water as easy as turning on a faucet.

#### ***This is how your dispenser works***

Water is electrically heated to near boiling (190°F/88°C) in a compact tank that mounts under the sink. A thermostat maintains it at this approximate temperature. When you turn the handle, cold water enters the tank and forces hot water out of the faucet. The system is vented so the tank is not pressurized.



**NOTE:** Due to the unique operation of your Instant Hot Water Dispenser, you may experience a slight delay in the dispensing of water after the handle is actuated. This assures maximum water temperature and is not indicative of a problem with the unit.

#### **WARNING!!**

**This product dispenses water at approximately 190°F, which is hot enough to cause severe burns. Caution should be exercised when installing and using this product. Do not allow children to operate this appliance without adult supervision.**

#### **CAUTION!!**

Do not, under any circumstances use bleach, abrasive liquids, powders or scouring pads to clean the faucet as doing so could void the warranty. Occasional cleaning with a soft cloth and warm soapy water is sufficient.

### 4-14.16.2 Adjusting Temperature

The thermostat is factory pre-set at approximately 190°F (88°C). If the temperature needs to be adjusted, follow the steps outlined below.

1. Unplug or disconnect the unit from the electrical supply.
2. Remove the screw securing the access cover to the unit.
3. Insert a small flat blade screwdriver into the thermostat adjusting screw.
4. Turn the screw ½ dial marker clockwise to increase the temperature (1/2 dial marker counterclockwise to decrease water temperature).
5. Replace access cover and screw.
6. Reconnect the electrical supply.
7. Draw three (3) cups of water and allow the unit to reheat.
8. Check the water temperature and repeat the process if necessary.

**Do not allow the unit to boil.**

### 4-14.16.3 Draining the Tank

1. Unplug or disconnect the unit from the electrical supply.
2. Allow water to run from the dispenser head until cool (approximately ½ gallon).
3. Shut off the supply of water to the dispenser.
4. Place a drain pan or other similar container underneath the tank.
5. Remove the drain cap located at the bottom of the tank and drain water (approximately ½ gallon).
6. Replace drain cap. Do not over tighten.
7. Reconnect water supply.
8. Actuate dispenser head handle until water flows from the dispenser head.
9. Reconnect the electrical supply.

### 4-14.16.4 Seasonal Storage

Seasonal storage of the unit is recommended if the unit is to be left unattended for long periods of time (typically more than two weeks) particularly if the unit could be exposed to freezing temperatures.

1. Unplug or disconnect the unit from the electrical supply.
2. Allow water to run from the dispenser head until cool (approximately ½ gallon).
3. Shut off the supply of water to the dispenser.
4. Place a drain pan or other similar container underneath the sink.
5. Remove the drain cap located on the bottom of the tank and drain water (approximately ½ gallon).
6. Replace drain cap. Do not over tighten.

#### CAUTION!!

**Remember – do not reconnect the electrical supply unless the tank is completely filled with water and water flows from the dispenser head.**

### 4-14.16.5 Cleaning

Use only a soft cloth and warm soapy water to clean the dispenser head and tank. The use of harsh cleaning agents containing acids, alkaline and organic solvents can destroy the dispenser head and tank finishes.

Problem	Possible Cause	What to Do
Water is not hot	Unit not plugged in or electric outlet is inoperative.	Check that the unit is connected to a properly grounded electric outlet and that circuit breakers or fuses are in good order.
	Thermal overload protector has tripped	Contact your In-Sink-Erator dealer for service.
Water too hot or not hot enough	Thermostat not adjusted to your taste	Adjust thermostat. See <a href="#">Adjusting Temperature</a> .
Water dripping from the spout or vent: <ul style="list-style-type: none"> <li>• When heating</li> <li>• Constantly</li> </ul>	Low water pressure preventing the expansion chamber from draining properly.	Unplug the unit. If the dripping stops within a few minutes, your water pressure may not be sufficient to properly drain the expansion chamber.  Check that there are no obstructions in the water line reducing the supply pressure below 20 pounds per square inch. For example: a poorly mounted saddle valve, a clogged water filter (not supplied), or a partially opened shut-off valve (not supplied).
	Construction debris from water line obstructing the faucet valve seat causing a slow water leak.	Contact your In-Sink-Erator dealer for service.
Water comes out the vent instead of the spout.	Outlet tube is blocked Flow straightener is blocked	Check that the outlet tube is not kinked, twisted or pinched. Remove flow straightener from end of spout by twisting counterclockwise. Remove any debris or scale accumulation. Soak in a mild vinegar solution if necessary to loosen scale deposits. Reinstall flow straightener by threading it on clockwise.
Water and steam spits forcefully from spout without turning on the dispenser faucet.	Unit is boiling	Reduce water temperature. See <a href="#">Adjusting Temperature</a> .
Water taste or odor	Normal start-up.	Under some water conditions your unit may need a few days to “season”. Open the dispenser faucet and run until the water is cold. Allow the unit to reheat. Repeat several times per day over 3-4 days to season the unit.
	Chlorine or contaminants in the incoming water supply may be more noticeable in hot water.	Provide a suitable drinking water filter. Contact your local water authority for suggestions.
Water does not flow immediately after the actuating handle.	Normal functioning of the unit	No correction needed.

## 4-14.17 Princess Two Burner Cook Top

The standard cook top supplied with the 450 LXi is a Princess two burner, gas cook top. Basic information concerning operating and maintaining your cook top follows:

### 4-14.17.1 What To Do if You Smell Gas

- Evacuate all persons from the coach.
- Shut off the gas supply at the gas container or source.
- Do not touch any electrical switch, or use any phone or radio in the coach.
- Do not start the coach's engine or electrical generator.
- Contact the nearest gas supplier or qualified service technician for repair.
- If you cannot reach a gas supplier or qualified service technician, contact nearest fire department.
- Do not turn on the gas supply until the gas leak(s) has been repaired.

### 4-14.17.2 Carbon Monoxide Poisoning

- Do not use any cooking appliance for space heating because of potential danger to occupants of the coach and damage to the cook top.
- A window or air vent should be open slightly while using any cooking appliance. Gas flame consumes oxygen which must be replaced to assure proper combustion and prevent carbon monoxide.



**NOTE:** Be sure you know where the main gas shut off valve is located so that you will know how and where to turn off the gas supply when necessary. There is a shutoff switch in the pantry area next to water pump switch. There is also a main shut off valve at the lp tank. It is recommended that user familiarize themselves with both of these shut off mechanisms in case of an emergency.

### 4-14.17.3 To Light the Burners

1. Push down the knob and turn counterclockwise to "IGNITE" position.
2. Hold the knob down fully until the spark ignites the gas and continue to hold the knob down for approximately 5 to 10 seconds. The thermocouple will be heated to activate the safety mechanism.
3. Release the knob and set to desired setting.
4. To turn off the burner flame, turn the knob clockwise to "OFF" position.

#### CAUTION!!

- Be sure your cook top is installed properly.
- Do not operate cook top if it is damaged or not working properly.
- Do not store flammable materials on or near the cook top.
- Never leave lit burners unattended. A boil over may result, causing smoke or fire.
- Do not use your cook top for warming or heating the room.
- The handle of utensil should be positioned so that they are turned inward but not extending over adjacent burner.
- To reduce the risk of burns and ignition of flammable materials, the burner flame should not extend beyond the edge of the cooking utensil.
- Grease is flammable. Never allow grease to collect around top burners or cook top surface. Wipe spillovers immediately.
- Only certain types of glass, glass/ceramic, earthenware, or other glazed utensils are suitable for cook top use without breaking due to sudden change in temperature.
- Do not use water on grease fire. Smother the fire or flame or use baking soda, multipurpose dry chemical or foam type fire extinguisher.
- Children should not be left alone or unattended in area where cook top is in use. Children should never be allowed to sit or stand on any part of the cook top.
- Do not heat unopened containers. They could explode.
- Do not touch burners, grates or areas near cook top after use. Units may be hot even though it may not be obvious. Areas near burners and grates may become hot enough to cause burns. During and after use, do not touch, or let clothing or other flammable material contact cook top or areas near it until they have had sufficient time to cool.

### 4-14.17.4 Care and Cleaning

Regular cleaning with a soft cloth and a warm detergent solution is generally enough to keep your cook top clean and beautiful. This is done when the cook top is cool. Use a dry cloth or paper towel to clean splatters and spills when surfaces are warm.

GLASS – We recommend the use of Hope's Cleaning Cream for care and maintenance of the glass surfaces. For more information about this product and a dealer near you, contact:

The Hope Company, Inc. – (800) 325-4026

## 4-14.18 Princess Two Burner Electric Cook Top (optional)

Offered as an option is the Princess Model 2247 Two Burner Ceran Glass Top Electric Stove.

### 4-14.18.1 Features

- Drop-in, flush mount Ceran glass
- Available in 120v or 240v.
- Halogen burners available, 240 volt only
- Limiters in burners to prevent overheating.
- Black glass top with white graphics.
- UL 858 Certified.
- 2 Burners
- 120 volts/20 amps
- 240 volts/15 amps per leg
- Overall Dimensions: 22W x 13D x 4H
- Cutout Dimensions: 21 3/8W x 12 3/8D x 4H
- Colors: White Graphics on Black
- Shipping Weight: 20 lbs.

### 4-14.18.2 Cleaning

It is recommended that the cook top be cleaned with non-abrasive cleaner such as warm soapy water and a soft cloth. For tough stains use a reputable cleanser designed for Ceran glass cook tops.

## 4-15 Fans, Vent and Exhaust

### 4-15.1 Fantastic Fan

12 VDC exhaust fan located in the bathroom.

#### 4-15.1.1 Operation

1. Open the damper from the control located on the face of the vanity.
2. Turn on the fan from the control located on the fan. Set the desired speed. The switch on fan may be left on in order for the vanity (remote) switch to operate all functions.



### 4-15.2 6" 12 VDC Pop-Up Fan

12 VDC six-inch exhaust fan is located in the private toilet area of models that are so equipped.

#### 4-15.2.1 Operation

1. Push handle up to open the vent.
2. Turn on the fan from the control located on the bottom of medicine cabinet.





## 4-16 Audio - Video Components

Beginning with Body Numbers W000361 there will be a few changes made to the audio-video components that are supplied with the coach. They are as follows:

The coach is supplied with state-of-the-art audio/video equipment. In the main galley area a 32" Panasonic High Definition Television, a Panasonic DVR unit with a 100 GB hard drive, an AV Control Receiver, and a DirectTV High Definition Satellite Receiver is installed. A 20" Panasonic television and a Panasonic VCR are installed in the bedroom area. Basic operation of all of these components is explained in this section. This will mean that High Definition satellite TV will be standard on our units and that the customer will be able to record 177 hours of programs on the DVR hard drive and be able to write programs onto a DVD disc.

The connections from these units to the TVs are being upgraded from S video to HDMI for the satellite receivers and component for the DVR unit. This will give the best picture resolution and clarity possible.

Because of these additional items the customer will have to deviate from the factory settings and set the settings to what is shown below for optimal picture benefit.

### **AUDIO/VIDEO SETTINGS**

#### **FRONT SYSTEM:**

The TV display should be set to 16:9 normal

The XR50 receiver should be set up with the correct inputs for audio and video.

The DVR Video output should be set to 480p via component cable

Video format should be 16:9 normal or full.

Audio output should be set to "bitstream".

The Sateillite receiver should be set to 1080i via HDMI

Video format should be 16:9 normal or full.

Audio output should be set to "bitstream".

#### **THE REAR SYSTEM:**

The TV display should be set to 16:9 normal

The DVD video output should be set to 480p

Video format should be 16:9 normal or full.

The Satellite receiver should be set to 1080i via HDMI

Video format should be 16:9 normal or full.

Audio output should be set to "bitstream".

## 4-16.1 Basic Operating Instructions

### 4-16.1.1 Living Room

From the living room, to watch something, pick up remote and make sure screen is on the “Main” menu. If not, press the “Main” button below the LCD screen.

Next, press the button “FT. TV” this is short for front TV, and then press the button next to what you want to watch, “SAT”, “DVD”, “VCR”, “CABLE”, and “OFAIR”, that’s the TV antenna.

To play CD’s use the “DVD” button.

Make sure remote is held pointing towards the TV when pressing buttons and hold there until everything turns on.



**NOTE:** It is not necessary to hold buttons down, a quick press of a button should do it.

Remote can also control equipment separately. Go back to the “Main” screen and press the button next to what you want to control. The items on the left are for the living room, items on the right are for the bedroom.

### 4-18.1.2 Bedroom

Everything is exactly the same for the bedroom, except instead of pressing “FT. TV” select “BEDTV” short for bedroom TV.

### 4-16.1.3 Shutting Down

The system can be shut down from either the Living Room or the Bedroom. Hold remote pointed at the either TV and hit off and entire system will shut down.

## 4-16.2 Panasonic 32” High Definition Television

In the galley area a Panasonic 32” High Definition Television is installed. General operating instructions and troubleshooting tips are as follows:

### 4-16.2.1 Important Safety Instructions

**Note to CATV System Installer:** This reminder is provided to direct the CATV system installer’s attention to Article 820-40 of the NEC that provides guidelines for proper grounding and, in particular, specifies that the cable ground shall be connected to the grounding system of the building, as close to the point of cable entry as practical.

#### Important Safety Instructions for LCD TV

- 1) Read these instructions.  
All the safety and operating instructions should be read before the appliance is operated.
- 2) Keep these instructions.  
The safety and operating instructions should be retained for future reference.
- 3) Heed all warnings.  
All warnings on the appliance and in the operating instructions should be adhered to.
- 4) Follow all instructions.  
All operating and use instructions should be followed.
- 5) Do not use this apparatus near water.  
For example, near a bathtub, wash bowl, kitchen sink, or laundry tub, in a wet basement, or near a swimming pool, and the like.
- 6) Clean only with a dry cloth.  
Do not use liquid cleaners or aerosol cleaners. Use a dry cloth for cleaning.

- 7) Do not block any ventilation openings. Install in accordance with the manufacturer's instructions.
- 8) Slots and Openings in the cabinet are provided for ventilation and to ensure reliable operation of the product and to protect it from overheating. The openings should never be blocked by placing the product on a bed, sofa, rug, or other similar surface.
- 9) Do not install near any heat sources such as radiators, heat registers, stoves, or other apparatus (including amplifiers) that produce heat.
- 8) This product should not be placed in a built-in-installation such as a bookcase or rack unless proper ventilation is provided or the manufacturer's instructions have been adhered to.
- 9) Do not defeat the safety purpose of the polarized or grounding-type plug. A polarized plug has two blades with one wider than the other. A grounding type plug has two blades and a third grounding prong. The wide blade or the third prong are provided for your safety. If the provided plug does not fit into your outlet, consult an electrician for replacement of the obsolete outlet.
- 10) Protect the power cord from being walked on or pinched particularly at plugs, convenience receptacles, and the point where they exit from the apparatus.
- 11) Use only attachments/accessories specified by the Manufacturer.
- 12) Use only with the cart, stand, tripod, bracket, or table specified by the manufacturer, or sold with the apparatus combination to avoid injury from tip-over. Quick stops, excessive force, and uneven surfaces may cause the appliance and cart combination to overturn.
- 13) Unplug this apparatus during lightning storms or when unused for long periods of time.
- 14) Refer all servicing to qualified service personnel. Servicing is required when the apparatus has been damaged in any way, such as the power-supply cord or plug is damaged, liquid has been spilled or objects have fallen into the apparatus, the apparatus has been exposed to rain or moisture, does not operate normally, or has been dropped.
- 15) To prevent electric shock, ensure the grounding pin on the AC cord power plug is securely connected.
- 16) If an outside antenna is connected to the television equipment, be sure the antenna system is grounded so as to provide some protection against voltage surges and built up static charges. The U.S. Selection 810-21 of the National Electrical Code provides information with respect to proper grounding of the mast and supporting structure, grounding of the lead-in wire to an antenna discharge unit, size of grounding conductors, location of antenna discharge unit, connection to grounding electrodes, and requirements for the grounding electrode.
- 17) An outside antenna system should not be located in the vicinity of overhead power lines or other electric light or power circuits, or where it can fall into such power lines or circuits. When installing an outside antenna system extreme care should be taken to keep from touching power lines or circuits as contact with them might be fatal.
- 18) Unplug this LCD TV from the wall outlet, and refer servicing to qualified service personnel under the following condition
  - a) When the power cord or plug is damaged or frayed.
  - b) If liquid has been spilled into the LCD TV.
  - c) If the LCD TV has been exposed to rain or water.
  - d) If the LCD TV does not operate normally by following the operating instructions.
  - e) Adjust only those controls that are covered by the operating instructions as improper adjustment of other controls may result in damage and will often require extensive work by a qualified technician to restore the LCD TV to normal operation.
  - f) If the LCD TV has been dropped or the cabinet has been damaged.
  - g) When the LCD TV exhibits a distinct change in performance - this indicates a need for service.

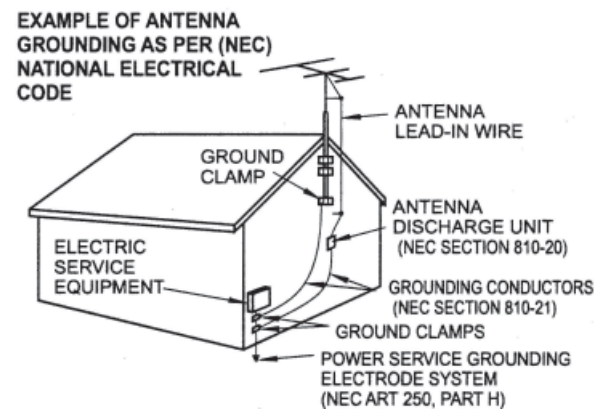

- 19) When replacement parts are required, be sure the service technician uses replacement parts specified by the manufacturer that have the same characteristics as the original part. Unauthorized substitutions may result in fire, electric shock, or other hazards.
- 20) **WARNING: TO REDUCE THE RISK OF FIRE OR ELECTRIC SHOCK, DO NOT EXPOSE THIS APPARATUS TO RAIN OR MOISTURE.**  
DO NOT PLACE LIQUID CONTAINERS (FLOWER VASES, CUPS, COSMETICS, ETC.) ABOVE THE SET. (INCLUDING ON SHELVES ABOVE, ETC.)
- 21) **CAUTION: TO PREVENT ELECTRIC SHOCK DO NOT USE THIS PLUG WITH A RECEPTACLE OR OTHER OUTLET UNLESS THE BLADES CAN BE FULLY INSERTED TO PREVENT BLADE EXPOSURE.**



**NOTE:** This equipment is designed to operate in the U.S.A. and other countries where the broadcasting system and AC house current is exactly the same as in the U.S.A.

The marking or retained image on the LCD panel resulting from fixed image use is not an operating defect and as such is not covered by Warranty. This product is not designed to display fixed image patterns for extended periods of time.

#### Important Information Regarding Use of Video Games, Computers, Captions or Other Fixed Image Displays.

The extended use of fixed image program material can cause a permanent "shadow image" on the LCD panel. This background image is viewable on normal programs in the form of a stationary fixed image. This type of irreversible LCD panel deterioration can be limited by observing the following steps:

- A. Replace the brightness/contrast setting to a minimum viewing level.
- B. Do not display the fixed image for extended periods of time.
- C. Turn the power off when not in actual use.

This product utilizes tin-lead solder, and has a fluorescent lamp containing a small amount of mercury. Disposal of these materials may be regulated in your community due to environmental considerations. For disposal or recycling information please contact your local authorities, or the Electronics Industries Alliance: [www.eiae.org](http://www.eiae.org).

### 4-16.2.2 Connections

#### Connecting the Antenna Cable to the Antenna Terminal

**Antenna Connection** - For proper reception of VHF/UHF channels, an external antenna is required. For best reception an outdoor antenna is recommended. Antenna Mode must be set to TV.

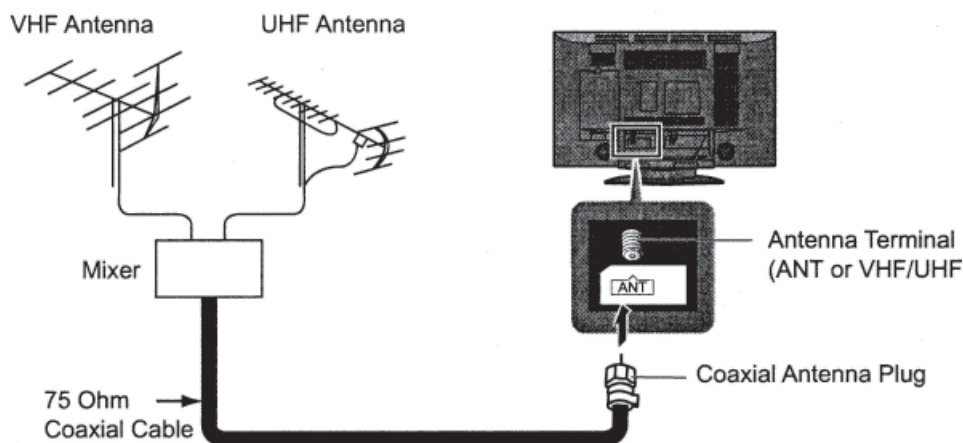

### 4-16.2.3 Antenna Cover Removal and Fitting

#### REMOVAL

1. Push up hooks and pull the cover slightly towards yourself to disengage the claws (at 4 points)
2. Slowly pull out in the downward direction.

#### FITTING

1. Insert the claws (at 4 points) at the top end.
2. Push it until hook is locked.

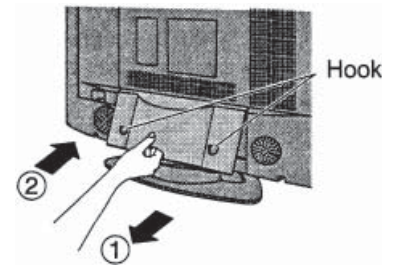

**NOTE:** To avoid interference appearing on the screen, do not bundle the antenna wire and AC adapter wire together.

### 4-16.2.4 Antenna/Cable Connection

Incoming 75 Ohm Cable from Home Antenna/Cable Company

**Cable Connection** - For reception of cable channels (01-125) connect the cable supplied by your local cable company. Antenna Mode must be set to CABLE. (Refer to [Antenna Mode](#) section.)

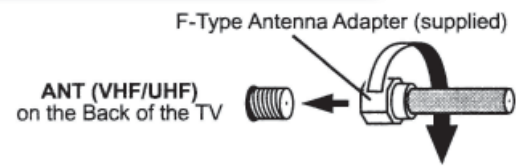

**NOTE:** Certain cable systems offset some channels to reduce interference or have Premium (scrambled) channels. A cable converter box is required for proper reception. Check with your local Cable company for its compatibility requirements.

### 4-16.2.5 Antenna Connection (Cable Box, no VCR)

Use this configuration when connecting the TV to a cable TV system using a Cable Box.

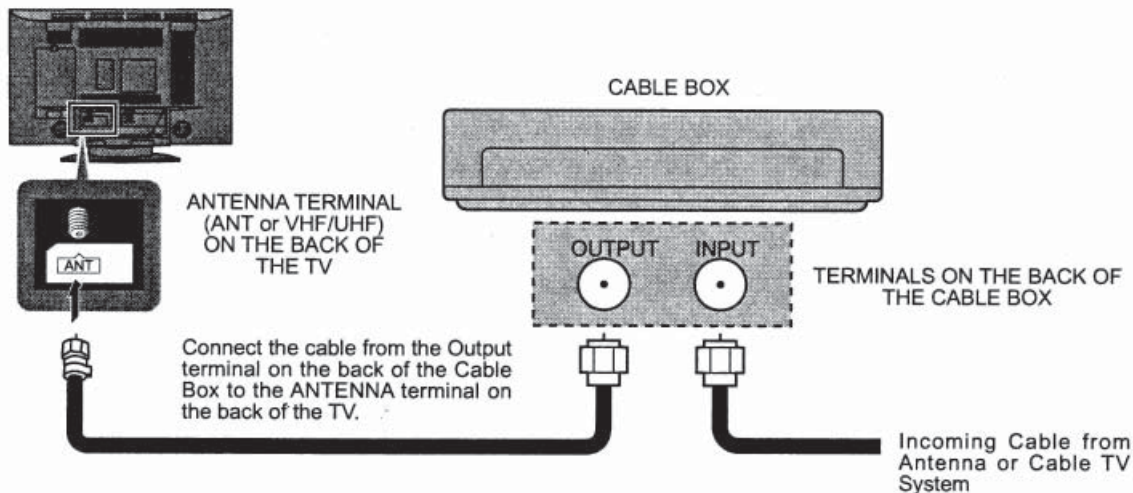

### 4-16.2.6 Antenna Connection (Cable Box, and VCR)

Use this configuration when connecting the TV to a cable TV system using a Cable Box and VCR.

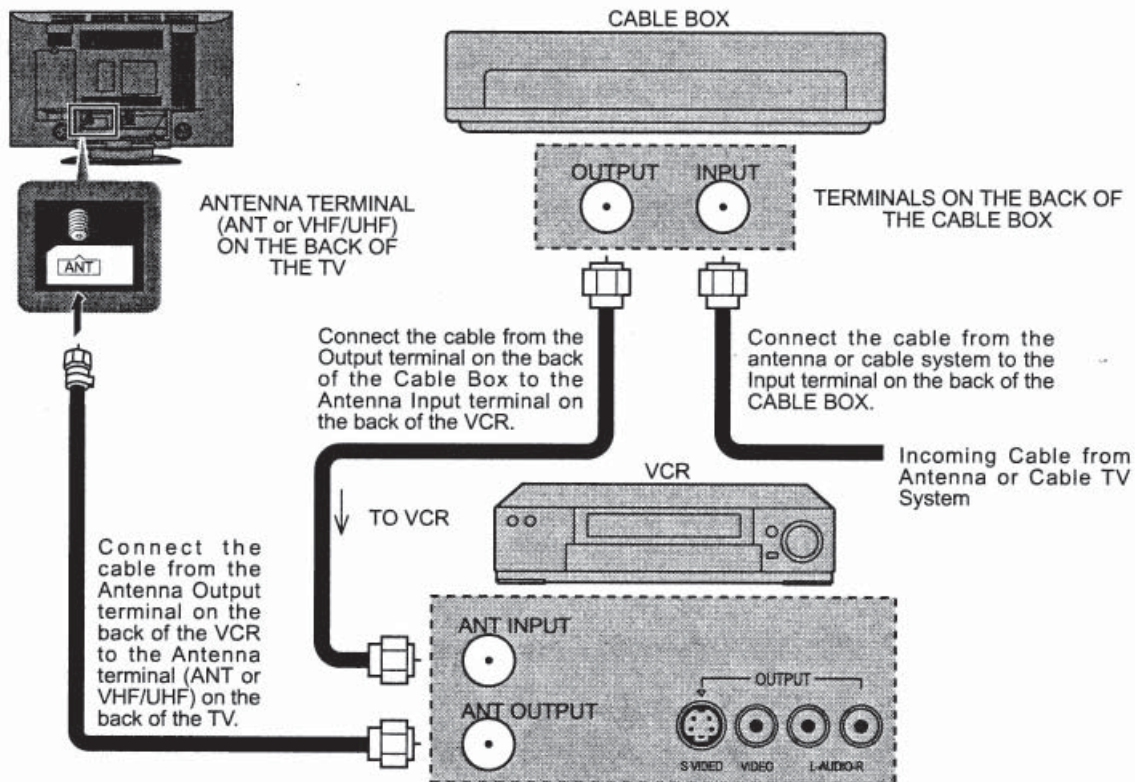

**NOTE:** When the antenna cable is connected to the TV antenna terminal via a cable box or VCR, set the TV channel to CH3 or CH4, cable. This does not apply when signal is input from VIDEO INPUT.

### 4-16.2.7 Cable Cover Removal and Fitting

#### Removal

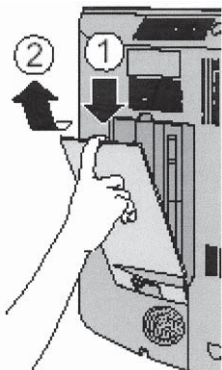

1. Disengage the claws at the uppermost end.
2. Slowly pull out in the upward direction.

#### Fitting

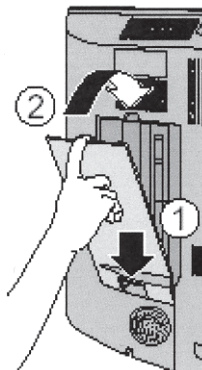

1. Insert the claws (at 2 points) at the bottom.
2. Push in the TOP.

**NOTE:** Depending on the type of cable used it may not be possible to close the cover. In such cases the cable may be routed through the antenna cover.

### 4-16.2.8 How to Connect the Input Terminals in Front

Connect camcorder and video game console.

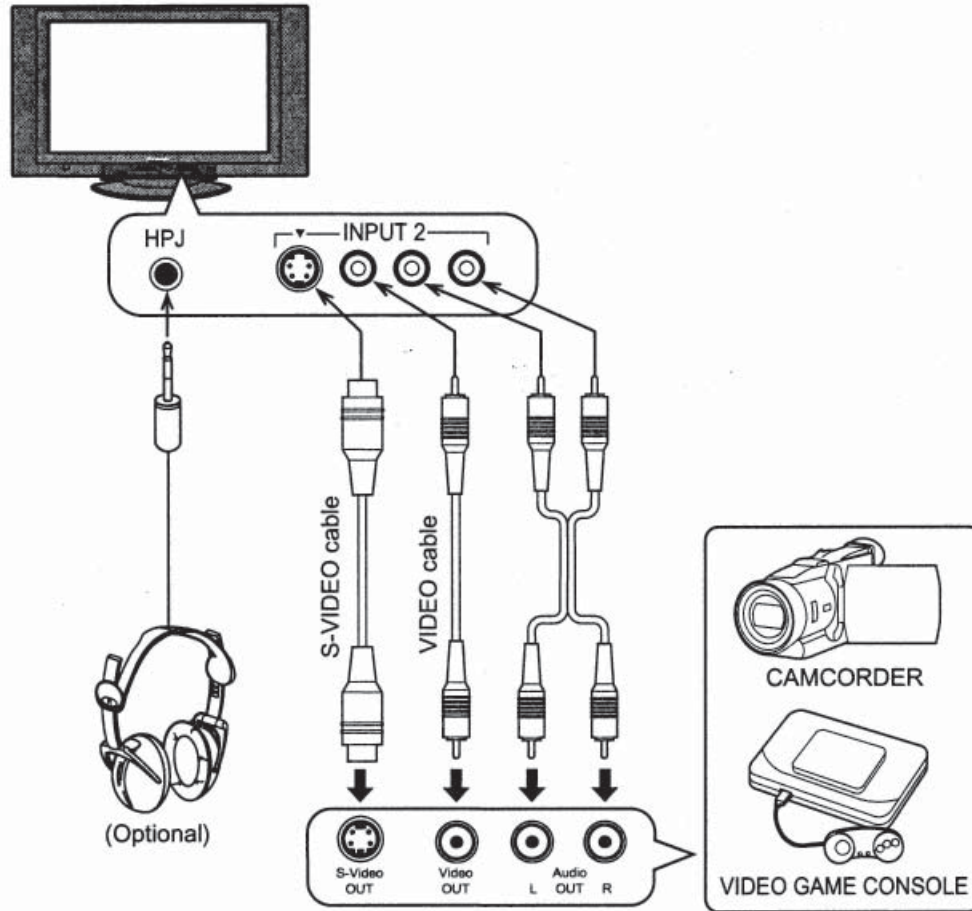

### 4-16.2.9 How to Connect with Other Equipment

Connect VCR and other peripheral equipment

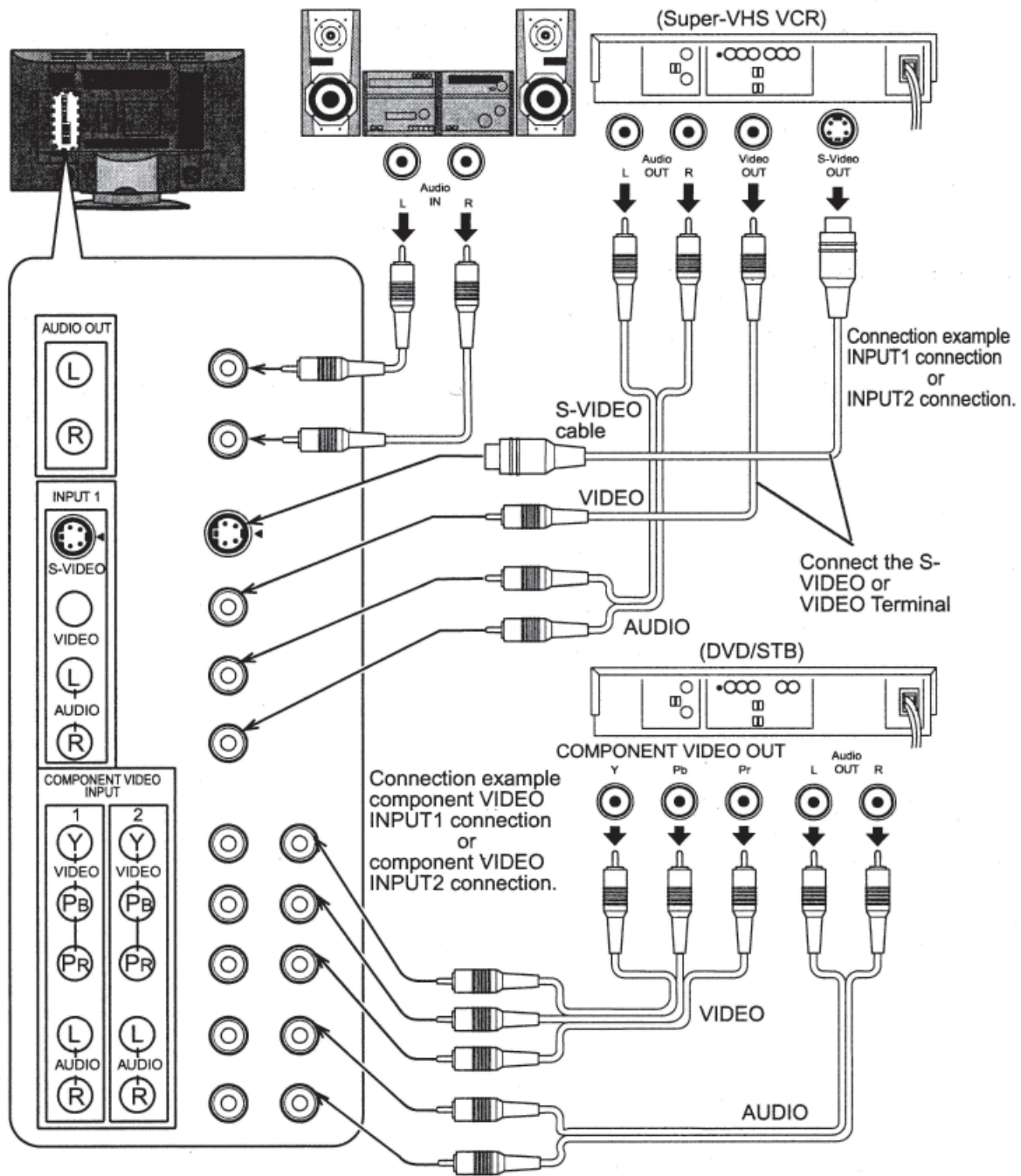

**NOTES:**

- When connecting video cables, priority is given to the S-Video cable when the S-Video input terminal and the video input terminal are connected at the same time.
- The volume control output of the LCD TV will be fixed. (SOUND, ADJUST, VOLUME UP/DOWN and SURROUND ON/OFF are not functional for output signals from the AUDIO OUT terminals.)



### 4-16.2.10 How to Connect the HDMI Terminal

HDMI\*1 (HDMI: High Definition Multimedia Interface) is the first all digital consumer electronics A/V interface that supports uncompressed standard. One jack supports both video and audio information.

This HDMI\*1 input can be connected to an EIA/CEA-861/861B\*2 compliant consumer electronic device, such as a Set Top Box or DVD player equipped with HDMI or DVI output connection.

By inputting a High-bandwidth Digital Content Protection (HDCP) high-definition picture source to the HDMI terminal of this television, high-definition pictures can be displayed on the screen in their digital form.

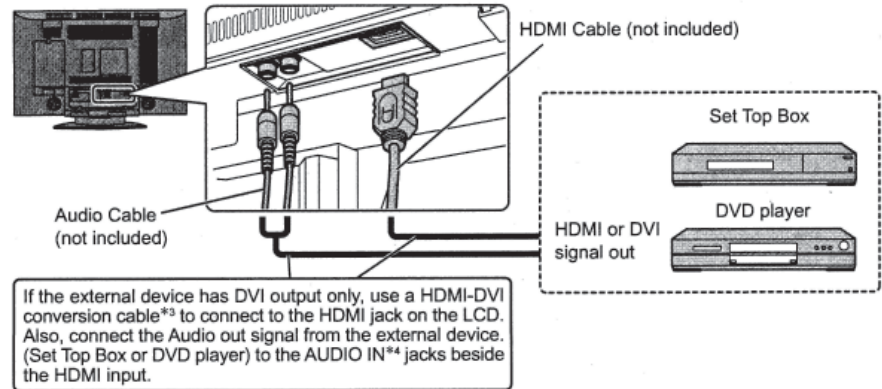

#### Applicable VIDEO Signal

This model supports following format.

Please adjust the format of connecting equipment.

	No. of Dots (H x V)	Vertical Scanning Frequency (Hz)
1080i	1,920 x 1,080i	59.94/60
480P	720 x 480 P	59.94/60
	640 x 480 P	59.94/60
480i	720 (1,440) x 480i	59.94/60

This input terminal is not intended for use with computers.

#### AUDIO Signal (L.PCM)

When the digital sound signal is included at connecting HDMI equipment, L.PCM sound is available.

Sampling frequency

48KHz/44.1KHz/32KHz



#### NOTES:

- 1) This HDMI connector is Type A.
- 2) If you cannot display the picture because your Digital Set Top Box does not have a Digital OUT Terminal Output setting, use the component Video Input (or the S Video Input or Video Input). In this case the picture will be displayed as an analog signal.

\*1. HDMI, the HDMI logo and High-Definition Multimedia Interface are trademarks or registered trademarks of HDMI Licensing LLC.

\*2. EIA/CEA-861/861B profiles compliance covers profiles for transmission of uncompressed digital video including high bandwidth digital content protection.

\*3. HDMI-DVI conversion cable part no. (TY-SCH03DH); available from the Panasonic National Parts Center at 1-800-332-5368 or on the Panasonic Website (USA only) at [www.panasonic.com](http://www.panasonic.com).

\*4. AUDIO-IN, Please refer to [Audio Adjustment](#) section. (HDMI-IN)

### 4-16.2.11 Power ON/OFF

Connecting the Plug to the Wall Outlet

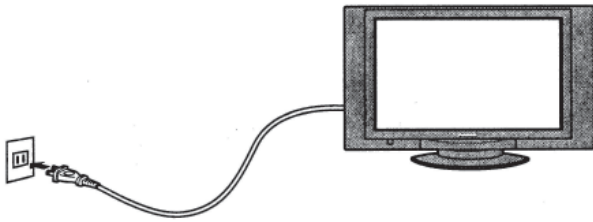

**NOTE:** The TV's power cord must first be plugged into the wall outlet.

#### 4-16.2.11.2 How to Turn the Power On

Press the Main POWER switch on the front of TV to turn the set on.

**POWER-ON:** Green

When the set is on or in standby mode press the Main POWER switch on the TV to turn the set off.

**POWER-OFF:** No light

Example: The screen below is displayed for a while after the TV is turned on. (setting condition is an example.)

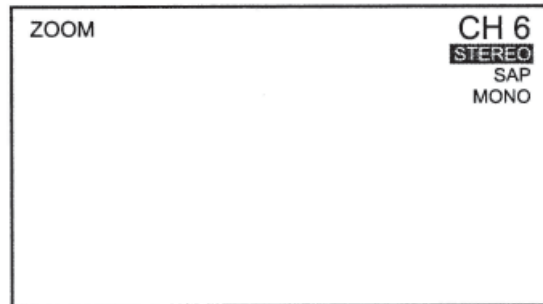
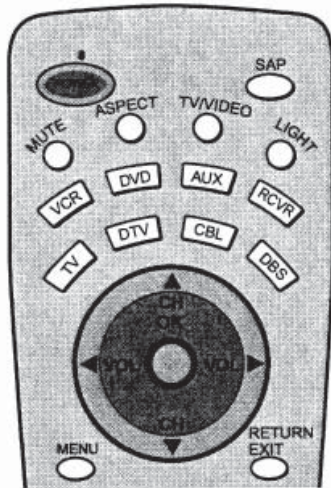
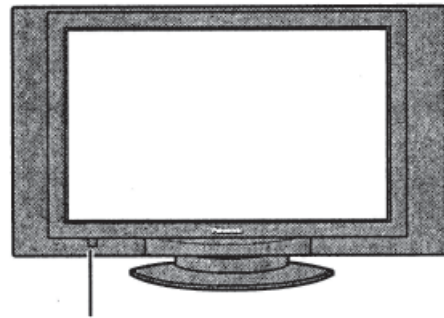

Press the POWER button on the remote control to turn the TV off: Red (standby)

Press the POWER button on the remote control to turn the TV on: Green

**NOTE:** The TV will still consume some power as long as the power cord is still plugged into the wall outlet.

### 4-16.2.12 Location of Controls

#### Illuminate Remote Control

**Power button**

Press to turn the TV ON or OFF.

**Note:** The TV's power cord must first be plugged into the wall outlet and then turned on at the POWER switch (standby mode).

**ASPECT button**

Change of screen size (See page 20).



**MUTE button**

Press this button to mute the sound, press again to cancel the mute.

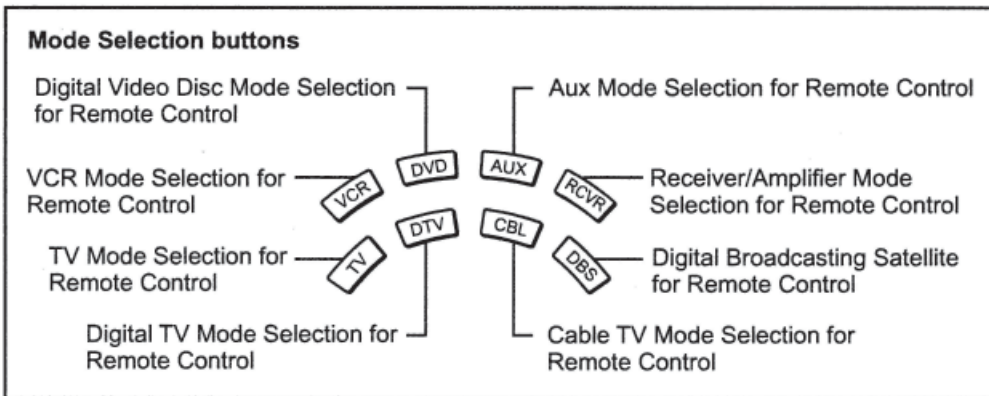

R-TUNE



**R-TUNE button**

Switches to previously viewed channel or video mode.

**Operation of other Device**

Buttons	REW / FF	PLAY	PAUSE	STOP
<b>Device</b>				
<b>VCR</b>	VCR REW/FF	PLAY	Pause	STOP
<b>CABLE/DBS</b>	—	—	—	—
<b>DVD/CD</b>	Skip Search REW/FF	PLAY	Pause	STOP
<b>RCVR</b>	Surround +/-	—	—	—

  

Buttons	REC	TV/VCR	VCR CH	OPEN/CLOSE
<b>Device</b>				
<b>VCR</b>	VCR RECORD	TV/VCR Switch	VCR CH up/down	—
<b>CABLE/DBS</b>	CABLE RECORD	—	CABLE CH up/down	—
<b>DVD/CD</b>	—	—	SLOW +/- /RAND. REP	OPEN/CLOSE
<b>RCVR</b>	—	—	Center +/-	—

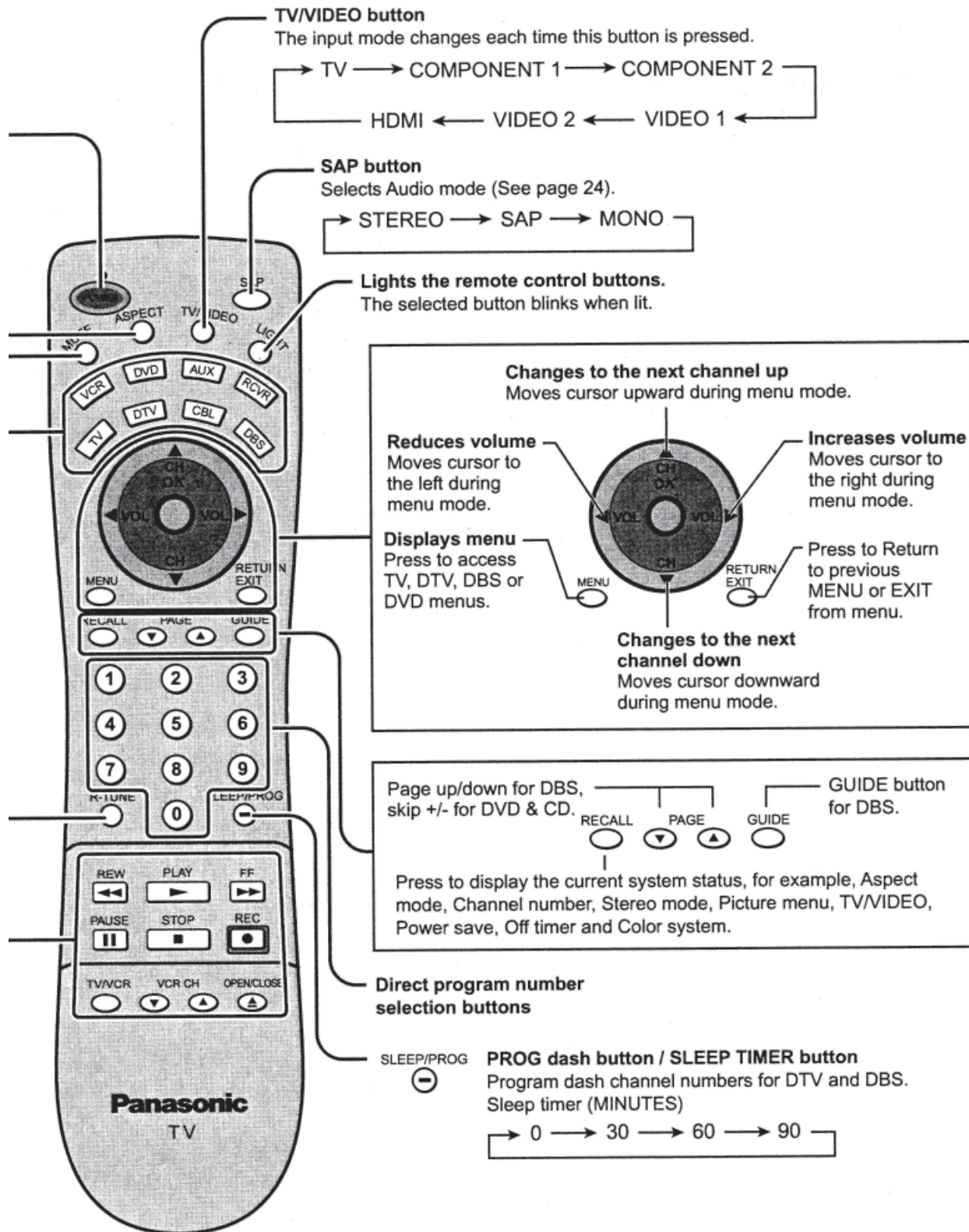

### 4-16.2.13 Flow Chart of MENU

All adjustments and setting functions available in this set can be made using the menu buttons. The menu screen is composed of 2 menus: the ADJUST menu and the SET UP menu.

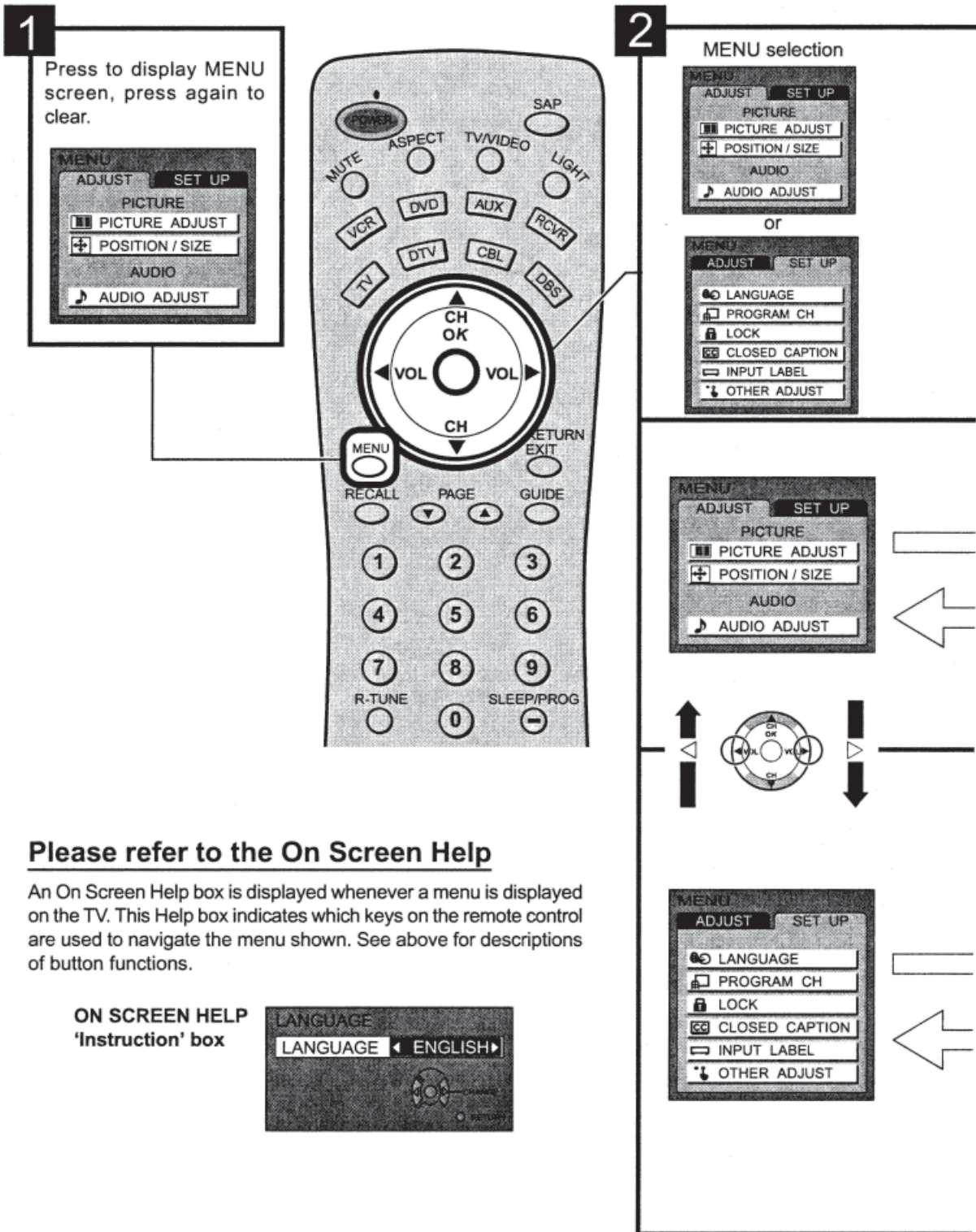

#### Please refer to the On Screen Help

An On Screen Help box is displayed whenever a menu is displayed on the TV. This Help box indicates which keys on the remote control are used to navigate the menu shown. See above for descriptions of button functions.

**ON SCREEN HELP**  
 'Instruction' box

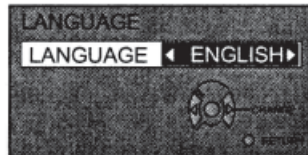

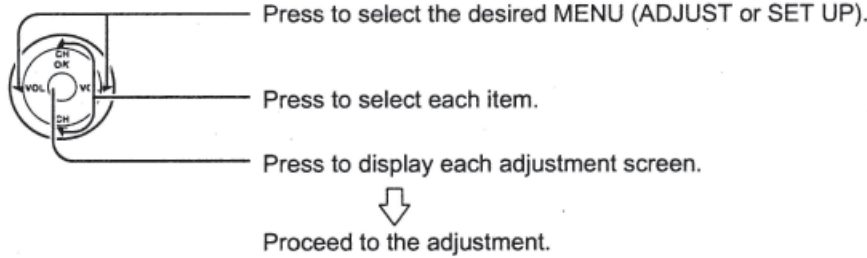

- To return to previous screen : Press to return.
- To end adjustments : Press to exit from the MENU screen. This returns the set to the normal viewing condition.

Press to display each adjustment screen.

→

Press the RETURN button to return to previous screen.

**TO PICTURE ADJUST menu**

(See page 21)

**TO AUDIO ADJUST menu**

(See page 24)

Press to display each adjustment screen.

→

Press the RETURN button to return to previous screen.

**TO LANGUAGE**

Allows you to select the language used for On Screen Displays.

**TO PROGRAM CHANNELS**

(See page 18,19)

**TO LOCK selection screen**

(See page 25)

**TO CLOSED CAPTION**

(See page 29)

**TO OTHER ADJUST screen**

(See page 30)

**TO INPUT LABEL selection screen**

(See page 30)

## 4-16.2.14 Remote Control Battery Installation

### Replacing Batteries

Replace batteries by following the steps below:

#### Requires two AA batteries.

1. Open the battery cover.
2. Install the batteries as shown in the battery compartment. (Polarity + or - must match the markings in the compartment).
3. Replace the cover.

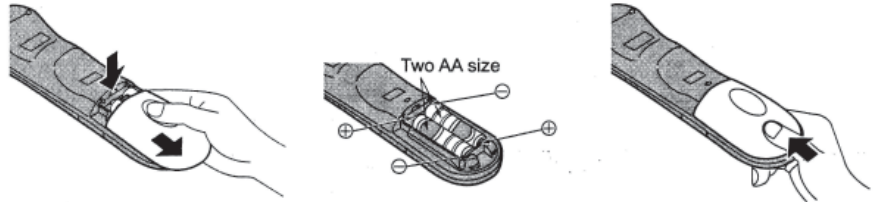

#### CAUTION!!

Precaution on battery use. Incorrect installation can cause battery leakage and corrosion that will damage the remote control transmitter.

#### Observe the following precautions:

1. Always use new batteries when replacing the old set.
2. Do not attempt to charge, short-circuit, disassemble, heat or burn used batteries.
3. Battery replacement is necessary when remote control acts sporadically or stops operating this unit.



#### NOTE:

- Do not drop, apply shock to or step on the remote control.
- Do not spill water on the remote control.
- Do not place objects between the remote control and remote control receiver.
- Do not use remote controls for other equipment at the same time.
- If the TV does not operate even when operating the remote control from a close range, it is time to replace the batteries.

## 4-16.2.15 Maintenance

To clean this unit, wipe with a soft, dry cloth.

If the surfaces are extremely dirty, use a soft cloth dipped in a soap and water solution or a weak detergent solution.

- Use eyeglass cleaner to remove stubborn dirt from the LCD.
- Never use alcohol, paint thinner or benzene to clean this unit.
- Before using a chemically treated cloth, read the instructions that came with the cloth carefully.

#### CAUTION!!

If water or similar substances get inside the monitor via the liquid crystal panel surface, a malfunction may result.

### 4-16.2.16 Tuning Channels (Automatic Channel Programming)

Automatically scans all TV channels and stores them in memory

**1** Turn the Power on and press the TV/VIDEO button to display the TV channel.

**2** Press the MENU button to display the MENU screen and select SET UP.

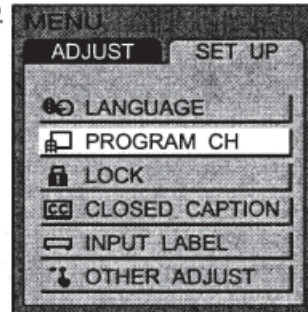
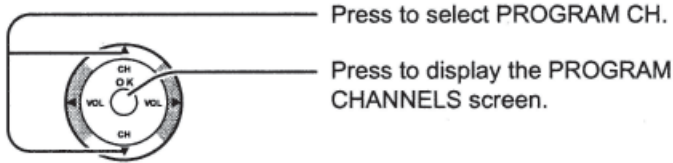

**3** Press to select MODE.

Press to select TV or CABLE.

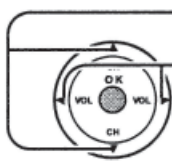

**4** Press to select AUTO PROGRAM.

Press to display the confirmation screen.

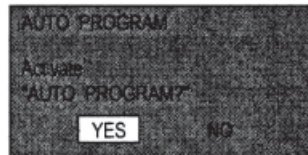
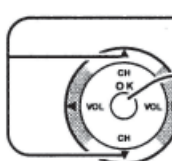

**5** Press to select YES.

Press to select NO.

Press to run AUTO PROGRAM.

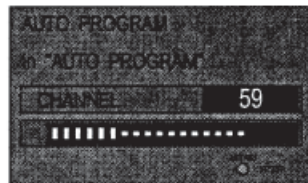

Channels will automatically advance until all channels have been scanned. Channel numbers with a video signal present will be stored in the Channel Scan Memory.

**MENU** Press to exit from the MENU screen. This returns the set to the normal viewing condition.

**NOTE:**

- When buttons are pressed with AUTO PROGRAM running, the TV set will return to normal viewing. (Channels searched up to this point are added.)
- After AUTO PROGRAM is finished, the lowest channel number added will be received.
- When there are no receivable channels, channel 60 is displayed for TV and channel 125 is displayed for cable TV.



### 4-16.2.17 Tuning Channels (Manual Channel Programming)

Use this setting when changing setting of receiving channels or changing the channel display.

Turn the TV on and select the broadcast channel. Follow the steps on the previous page to display the PROGRAM CHANNELS screen.

1

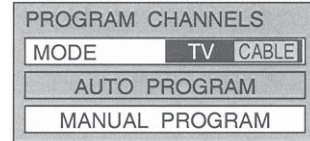
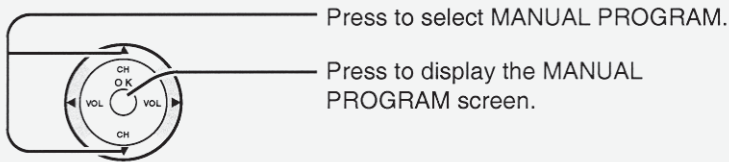

#### Adding or deleting channels

2

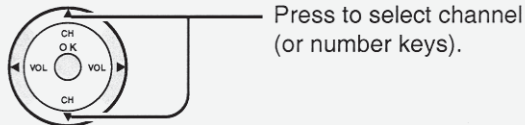

3

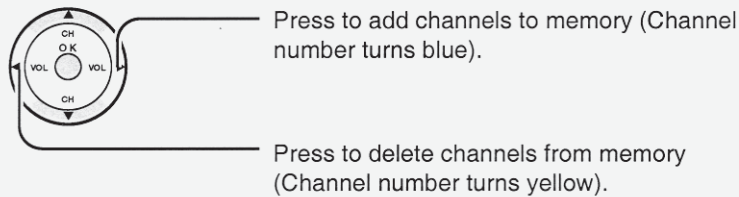

4 Repeat steps 2 and 3 to continue adding or deleting channels.

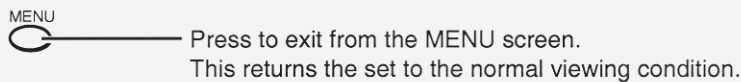

### 4-16.2.18 ASPECT Controls

The color monitor will allow you to enjoy viewing the picture at its maximum size, including wide screen cinema format picture.

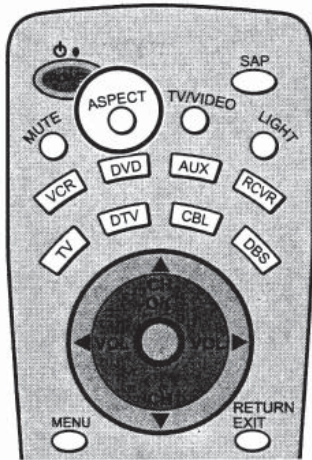

**ASPECT ASPECT Button**

The aspect mode changes each time the ASPECT button is pressed.

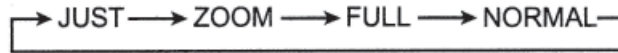

**NOTE:** When a 1080i signal is being received, the mode is set to FULL, and aspect switching is not possible.

Mode	Picture	Explanation
NORMAL		NORMAL mode will display a 4:3 picture at its standard 4:3 size.
JUST		JUST mode will display a 4:3 picture at its maximum size but with aspect correction applied to the sides of the screen so the elongation is only apparent at the left and right edges of the screen. The size of the picture will depend on the original signal.
ZOOM		ZOOM mode magnifies the central section of the picture.
FULL		FULL will display the picture at its maximum size but with slight elongation.

### 4-16.2.19 Picture Adjustments

**1** Press the MENU button to display the MENU screen and select ADJUST.

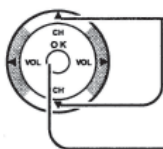

Press to select PICTURE ADJUST.

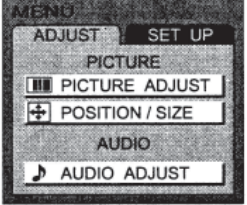

Press to display the PICTURE ADJUST screen.

**2** Press to select the menu to adjust.

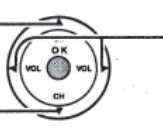

Select the desired level by looking at the picture behind the menu.



NORMAL is displayed at default.



**PIC MODE** PICTURE MODE is stored for TV, VIDEO1, VIDEO2, COMPONENT1, COMPONENT2 and HDMI individually.

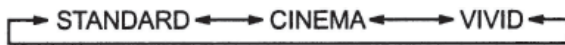

MODE	Function
<b>STANDARD</b>	Displays standard image.
<b>CINEMA</b>	Ideal for watching movies in a dark room.
<b>VIVID</b>	Displays a clear screen with contrast of light and dark.

### BACK LIGHT, PICTURE, BRIGHTNESS, COLOR, TINT, SHARPNESS, AI PICTURE, COLOR TEMP

You can change the level of each item (BLACK LIGHT, PICTURE, BRIGHTNESS, COLOR, TINT, SHARPNESS, AI PICTURE and COLOR TEMP) for each MENU (STANDARD, CINEMA, and VIVID) according to your personal preference.

Item	Function
<b>BACK LIGHT</b>	Luminance of the back light is adjusted.
<b>PICTURE</b>	Selects proper brightness and density for the room.
<b>BRIGHTNESS</b>	Adjusts for easier viewing of dark pictures such as night scenes.
<b>COLOR</b>	Adjusts the level of color
<b>TINT</b>	Adjusts for flesh tone color.
<b>SHARPNESS</b>	Adjusts the degree of sharpness.
<b>AI PICTURE</b>	Displays black and white colors more clearly when turned ON.
<b>COLOR TEMP</b>	Increase or decrease WARM (red) and COOL (blue) colors to suit personal preference.

To reset to standard setting:

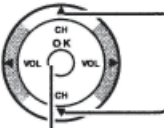

Press to select NORMALIZE.

Press OK.

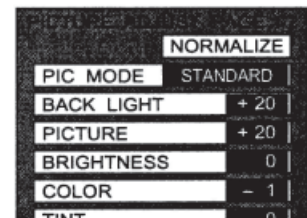

### 3 ADVANCED ADJUST

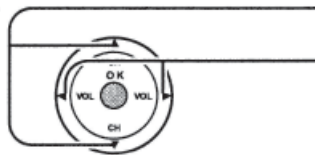

Press to select PIC MODE.

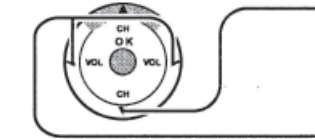

Select STANDARD or CINEMA.

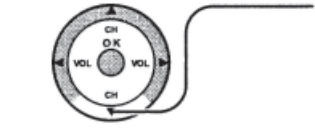

Press down to PAGE 2 and  
Select ADVANCED ADJUST.

Press to select ADVANCED  
ADJUST ON.

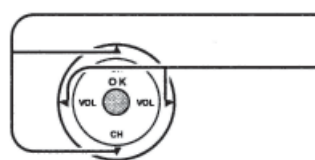

Press to go to NEXT PAGE.  
ADVANCED ADJUST will be  
Shown.



Press to select the menu to adjust.  
Select the desired level by looking at  
The picture behind the menu.

NORMAL is displayed at default.

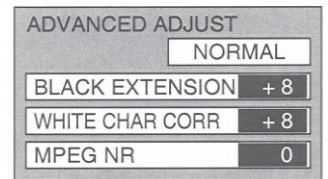
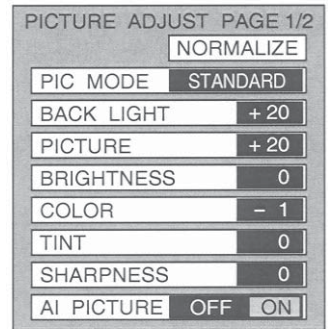

Item	Function
<b>BLACK EXTENSION</b>	Contrast level will be improved.
<b>WHITE CHAR CORR</b>	It makes white characters brighter.
<b>MPEG NR</b>	Noise unique to DVD, STB, etc. will be reduced.

### 4-16.2.20 Position/Size Adjustment

This function will adjust the picture position / size for easy viewing.

- 1 Press MENU button to display MENU screen and select adjust.

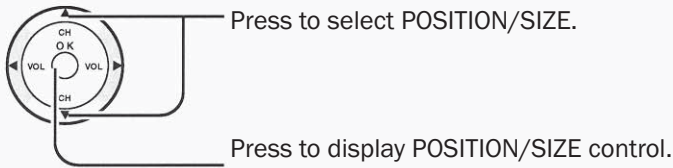

- 2 [Picture Position Adjustment]  
It will work for "ZOOM" mode only.

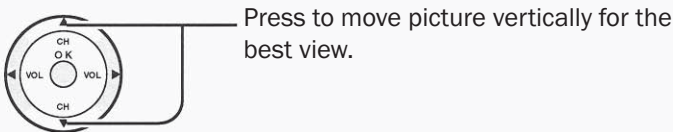

- 3 [Picture Size Adjustment]  
It will work for "NORMAL" and "ADJUST" mode only.

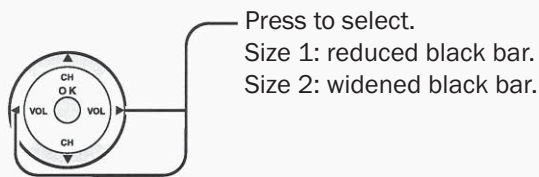

To return to previous screen:

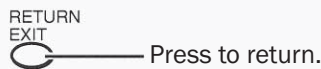

To reset to standard setting:

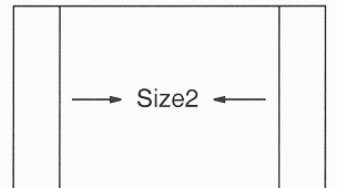
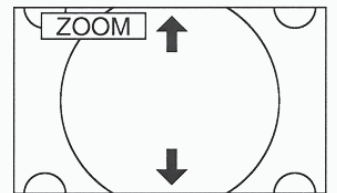
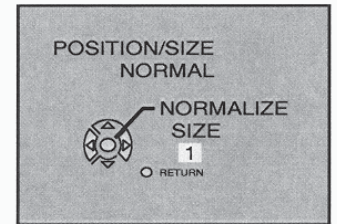
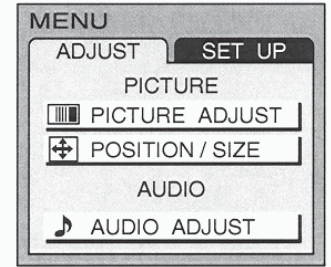
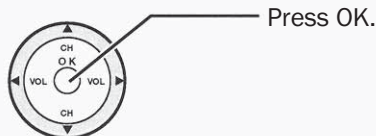

### 4-16.2.21 Audio Adjustments

**1** Press the MENU button to display the MENU screen and select ADJUST.

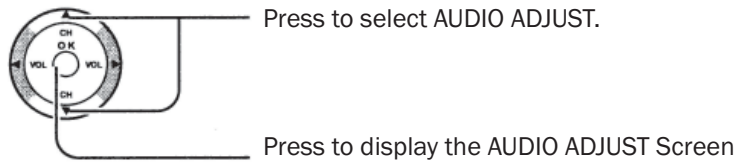

**2**

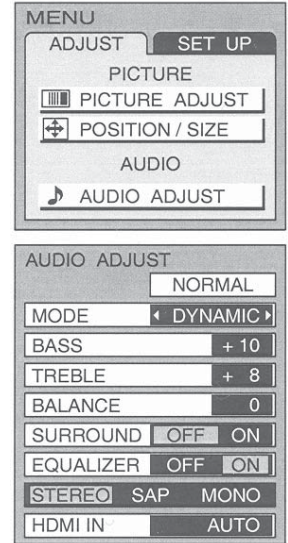
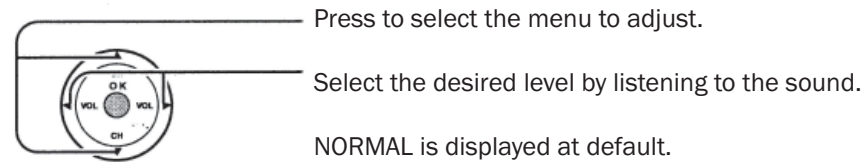

#### MODE



MODE	FUNCTION
<b>AUTO</b>	Automatically adjusts quiet sound and loud sound for ease of listening.
<b>STANDARD</b>	Emits the original sound.
<b>DYNAMIC</b>	Gives contrast to sound.

#### BASS, TREBLE, BALANCE, SURROUND, EQUALIZER

You can change the level of each item, (BASS, TREBLE, BALANCE, SURROUND, EQUALIZER) For each MODE (AUTO, STANDARD and DYNAMIC) according to your personal preference.

ITEM	FUNCTION
<b>BASS</b>	Adjusts low sounds.
<b>TREBLE</b>	Adjusts high sounds
<b>BALANCE</b>	Adjusts left and right volume
<b>SURROUND</b>	To enjoy a concert hall effect, turn SURROUND to ON when a stereo signal is available.
<b>EQUALIZER</b>	To make voice sound clear. Normally set to ON.

#### Selecting STEREO/SAP/MONO



**Note:**

- Red display : With signal
- White display : No signal
- White display : MONO

ITEM	FUNCTION
<b>STEREO</b>	Two channel Audio reception.
<b>SAP</b>	Second Audio Programming ( <i>typically used for bilingual audio</i> )
<b>MONO</b>	Use when stereo signal is weak

#### HDMI IN

Perform input switching of analog audio input (for DVI) and digital audio input (for HDMI) when using the HDMI terminal



<b>AUTO</b>	Set use of analog audio input when digital audio signal is not available.
<b>DIGITAL</b>	Forces use of digital audio input signal transmitted via the HDMI terminal.
<b>ANALOG</b>	Forces use of analog audio input signal transmitted via separate RCA terminals.

### 4-16.2.22 Lock Feature

In the United States, the V-CHIP consists of two rating systems, which are MPAA (MOTION PICTURE) and TV PARENTAL GUIDELINES. Its function is to block programs by the rating data in the XDS data packets sent from broadcasting stations. The user can select which rating programs should be blocked by the LOCK MENU options.

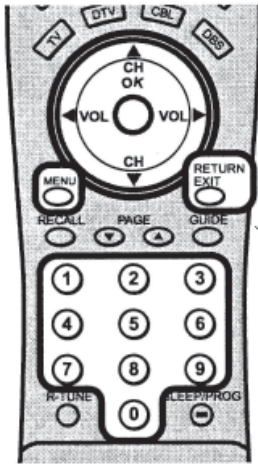

Press the MENU button to display the MENU screen and select SET UP.

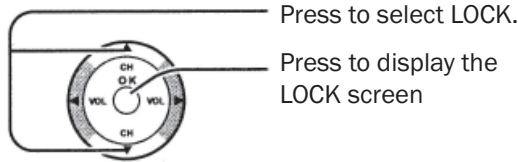

**Input code**  
Enter any 4 digit number as a password. These numbers will be needed when Deactivating the LOCK function.

While entering a code, by pressing the up ▲ or down ▼ buttons you can input a new code again.

After entering your secret code for the first time, the onscreen display will change to CHANGE CODE. And you can change the Input code.

**NOTE:** Use a code that is easy to remember and record it in a safe place.

#### 1 Selecting broadcasts to lock.

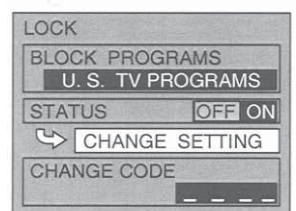
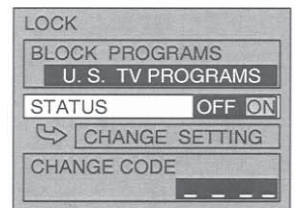
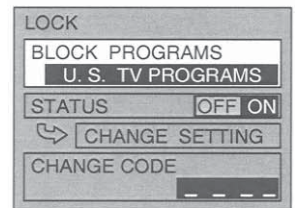
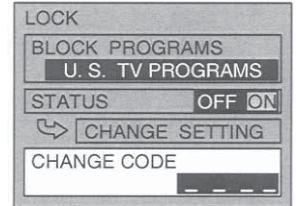
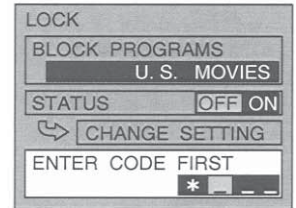
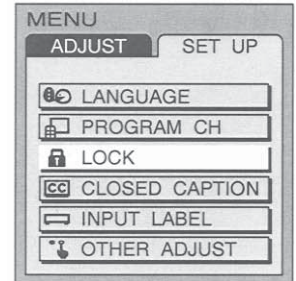
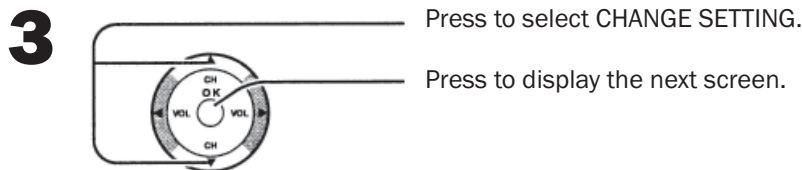
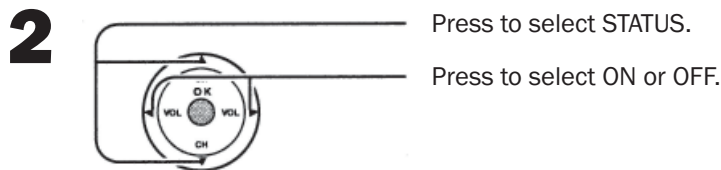
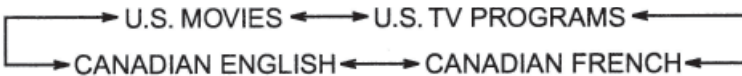
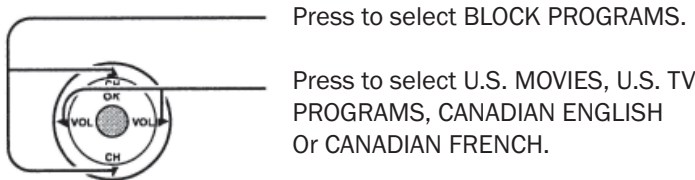

**For U.S. TV PROGRAM to lock**

- 1**

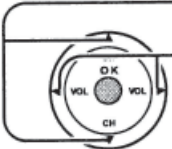

Press to select VIEW NR PROGRAMS?  
 Press to select NO or YES.  
 NO : Cannot view programs with NR signals  
 YES : Can view programs with NR signal.
- 2**

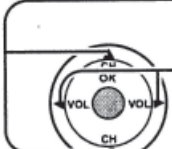

Press to select SETTING.  
 Press to select BASIC or DETAILED.

→ BASIC ← → DETAILED ←
- 3**

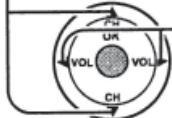

Press to select rating.  
**BASIC:** Change the selected title.  
**DETAILED:** The cursor selecting the title can be moved to select options displayed on the right.  
 Press to lock or unlock the rating.  
 Lock: Red  
 Unlock: Green

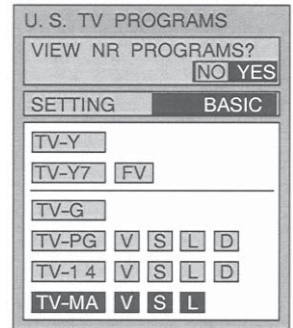
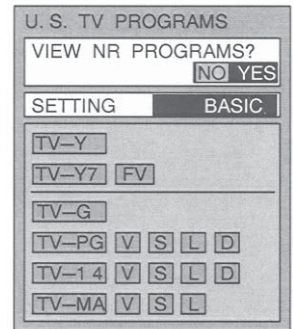



**Locking and unlocking**

- When a title field is selected, all ratings below this rating are selected.
- When options within an option field are selected, ratings below this rating within the same field are selected.
- Ratings displayed in green are unlocked and those displayed in red are blocked programs.
  1. Ratings for children: These ratings are divided into ranks as follows.

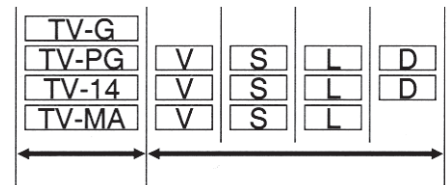

2. Ratings for teenagers: These ratings can be created out of these major categories to form various combinations. These combinations are described in the paragraphs to follow.



To return to previous screen:  Press to return.

To end adjustments:  Press to exit from the MENU screen.  
 This returns the set to the normal viewing condition.



**For U.S. MOVIES to lock**

**1**

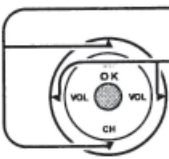

Press to select VIEW NR PROGRAMS?

Press to select NO or YES.

NO : Cannot view programs with NR signals.  
 YES : Can view programs with NR signal.

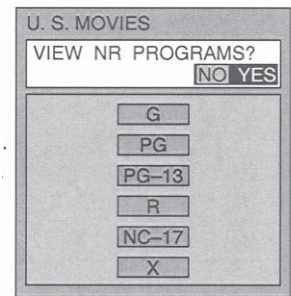

**2**

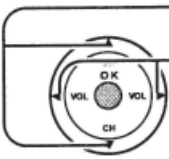

Press to select rating.

Press to lock or unlock the rating.

Lock: Red  
 Unlock: Green

**Rating**

- G : General audience
- PG : Parental guidance suggested  
Under 13 years old
- R : Restricted
- NC17 : No one under 17 is admitted
- X : Pornography

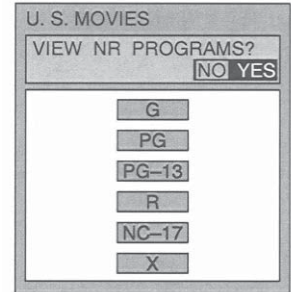

**For CANADIAN ENGLISH / CANADIAN FRENCH to lock**

**1**

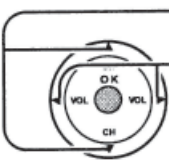

Press to select VIEW E PROGRAMS?

Press to select NO or YES

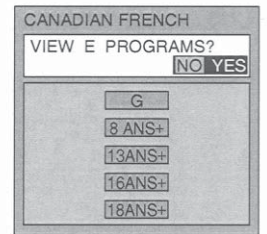
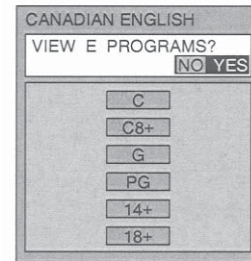

**2**

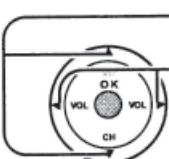

Press to select rating.

Press to lock or unlock the rating.

Lock: Red  
 Unlock : Green

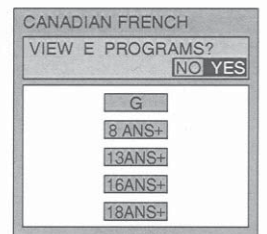
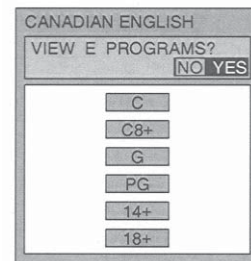

**CANADIAN ENGLISH RATINGS CHART**

<b>E</b>	Exempt - Exempt programming includes: news, sports, documentaries and other information programming, talk shows, music videos, and variety programming.
<b>C</b>	Programming intended for children under age 8. No offensive language, nudity or sexual content.
<b>C8+</b>	Programming generally considered acceptable for children 8 years and over. No profanity, nudity or sexual content.
<b>G</b>	General programming, suitable for all audiences.
<b>PG</b>	Parental Guidance suggested. Some material may not be suitable for children.
<b>14+</b>	Programming contains themes or content which may not be suitable for viewers under the age of 14. Parents are strongly cautioned to exercise discretion in permitting viewing by pre-teens and early teens.
<b>18+</b>	18+ years old. Programming restricted to adults. Contains constant violence or scenes of extreme violence.

**CANADIAN FRENCH RATINGS CHART**

<b>E</b>	Exempt - Exempt programming.
<b>G</b>	General - Programming intended for audience of all ages. Contains no violence, or the violence content is minimal or is depicted appropriately.
<b>8 ANS+</b>	8+ General - Not recommended for young children. Programming intended for a broad audience but contains light or occasional violence. Adult supervision recommended.
<b>13 ANS+</b>	Programming may not be suitable for children under the age of 13 - Contains either a few violent scenes or one or more sufficiently violent scenes to affect them. Adult supervision strongly suggested.
<b>16 ANS+</b>	Programming may not be suitable for children under the age of 16 - Contains frequent scenes of violence or intense violence.
<b>18 ANS+</b>	18+ years old. Programming restricted to adults. Contains constant violence or scenes of extreme violence.

To return to previous screen:  Press to return.

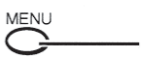
To end adjustments:  Press to exit from the MENU screen.  
This returns the set to the normal viewing condition.

### 4-16.2.23 Closed Captions

This unit has a built in decoder that provides a visual depiction of the audio portion of a television program in the form of written words across the screen (white or colored letters on a black background). It allows the viewer to read the dialogue of a television program or other information.

**1** Press the MENU button to display the MENU screen and select SET UP.

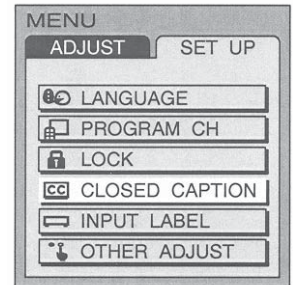
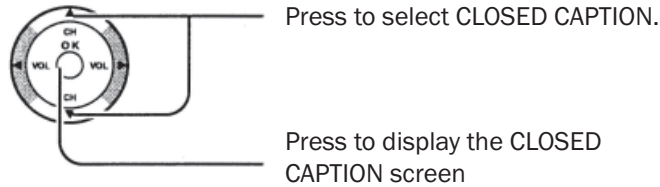

### 2 **CC** ON MUTE

Activates the On-Screen Closed Caption feature, when the MUTE button on the Remote Control is pressed. To deactivate, press the MUTE button again.

**NOTE:** This feature functions when the Closed Caption Mode is in the "OFF" position. The program being viewed must be broadcast with Closed Caption.

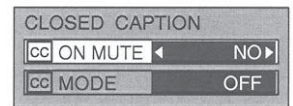
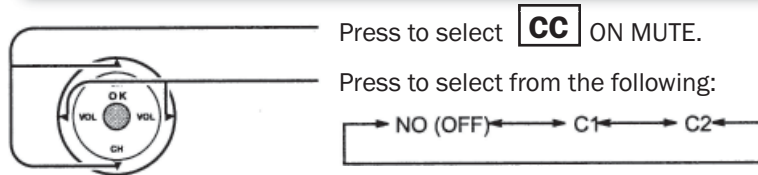

### 3 **CC** MODE

Activates the On-Screen Closed Caption feature. When activated this feature will remain on until OFF is selected in this menu.

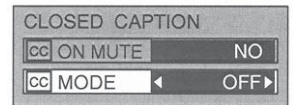
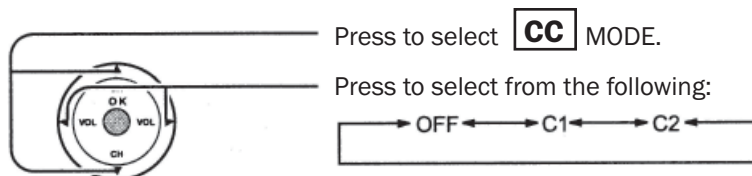

**CAPTION OFF** - Recommended mode when Closed Caption is not being used.

**CAPTION C1** - For video related information that can be displayed (up to 4 lines of script strategically placed on the television screen so that it does not obstruct relevant parts of the picture).

**CAPTION C2** - Another mode used for video related information.

To return to previous screen:  Press to return.

To end adjustments:  Press to exit from the MENU screen. This returns the set to the normal viewing condition.

### 4-16.2.24 Customizing the VIDEO INPUT labels

Display for each VIDEO INPUT can be changed to match with the connected device (VCR, DVD Player etc.).

**1** Press the MENU button to display the MENU screen and select SET UP.

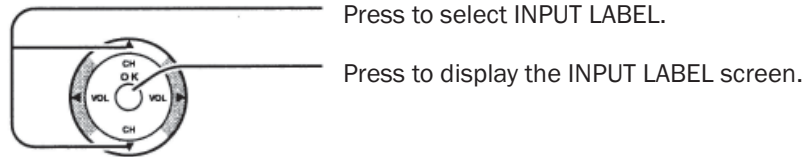

**2** Press to select the VIDEO INPUT.

Press to change the INPUT LABEL.

Each INPUT LABEL has the following choices.

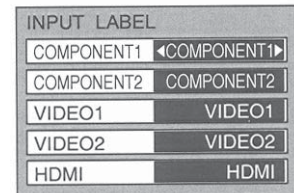
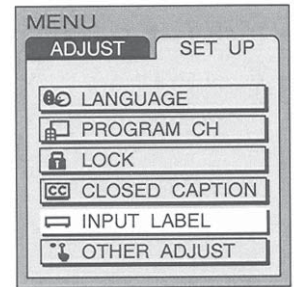
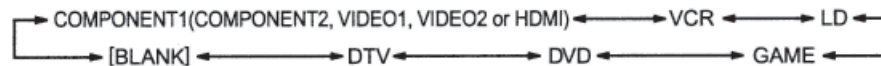

### 4-16.2.25 Other Adjust

**1** Press the MENU button to display the MENU screen and select SET UP.

**2** Press to select OTHER ADJUST.

Press to access OTHER ADJUST.

**3** Press to select the item that you would like to change.

Press to select desired condition.

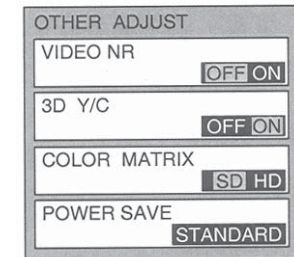
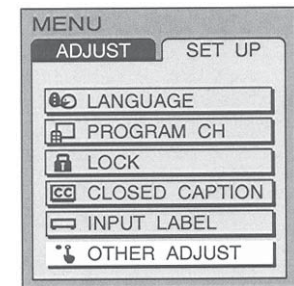

#### VIDEO NR

Reduce video noise in the picture.

Selection condition: ON ↔ OFF

#### 3D Y/C FILTER

Minimizes noise and cross color in the picture.

Not available for COMPONENT VIDEO.

Selection condition: ON ↔ OFF

#### COLOR MATRIX

Displays input signals (480p signals) in a natural color.

Automatically adjusts color parameters for HD (high definition) and SD (standard definition).

Selection condition: SD ↔ HD

#### POWER SAVE

The POWER SAVE will be suitable for watching at night and power consumption will be reduced.





Selection condition: STANDARD ↔ SAVING

## 4-16.2.26 Operational Peripheral Equipment Using the Remote Control

### Programming the Illuminated Remote Control Using Access Codes

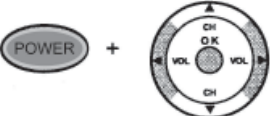
The Universal Remote Control can be programmed to operate many manufacturers' components, using the component function button for VCR, DVD, AUX, RCVR, TV, DTV, CABLE or DBS. Follow the procedures for programming your Remote Control with or without a code for the component.

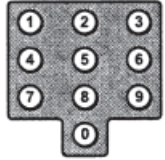
**Determine the manufacturer of the component and look in the table for the code.**

- 1** Confirm that the external component is plugged in and operating.
- 2** Turn the component off.
- 3**  Press and hold POWER and OK together, for at least 5 seconds. After 5 seconds, all the illuminated mode keys will begin to flash. Release the POWER and OK keys.
- 4**  Press the mode key. The mode key will illuminate steadily, all others will go out.
- 5**  Enter the 3-digit component code using the Remote Control numeric keypad.
- 6**  Press the Remote Control  to test the component. If the procedure is successful, the component will turn on.

### Default Modes for Remote Control

Device	Operates	Default
TV	TV (Panasonic Only)	Panasonic TV Codes
DTV	DTV (Panasonic Only)	Panasonic DTV Codes
CABLE	CABLE (Preset)	Panasonic CABLE Codes
DBS	DBS (Preset)	Panasonic DBS Codes
VCR	VCR (Preset)	Panasonic VCR Codes
DVD/CD	DVD and CD (Preset)	Panasonic DVD Codes
AUX	Personal Video Recorders, Tape and VCR2	Panasonic Personal Video Recorders Code
RCVR	Audio Receiver (Preset)	Panasonic RCVR Code

### Helpful Hints: Unsuccessful Code

If the component does not operate with the Remote Control, repeat the procedure using another code. (Some brands have multiple codes). If an incorrect code is entered, or if the procedure takes longer than 30 seconds, the programming will fail.

**Programming the Illuminated Remote Control Using Access Codes**

This procedure searches all codes and is called the “sequence method.”

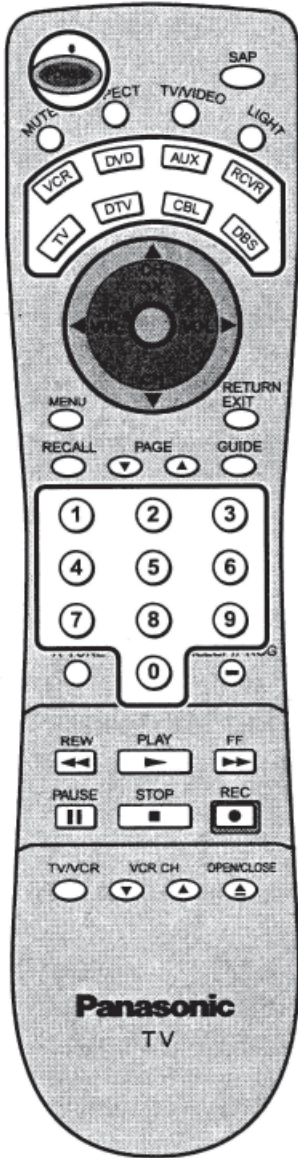

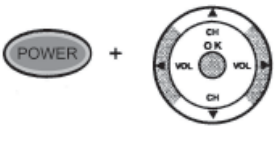

**1** Confirm that the external component is plugged in and on.

**2** Turn the component off.

**3**  Press POWER and OK together, for at least 5 seconds. After 5 seconds, all the illuminated mode keys will begin to flash. Release the POWER and OK key.

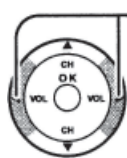
**4**  Press the mode key. The mode key will illuminate steadily, all others will go out.

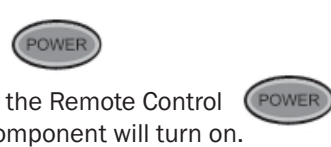
**5**  Press to move forward to the next code, or to move backward.

**6**  Press the Remote Control  to test the component. If the procedure was successful, the component will turn on.

 **NOTE:** Repeat the above steps until the component code is found. It may take many attempts before the correct code is found.

**7**  After the code is found, press OK to store the code.

 **NOTE:** The step and set mode will start from the current device (not the beginning of the list, except for the first time).

**4-16.3.27 Infrared Codes Index**

The remote control is capable of operating many brands of peripheral equipment. Refer to previous section for programming procedures.

 **NOTES:** The remote control memory is limited and therefore some models may not operate. The remote control is not designed to control all features available in all models.

After entering the proper infrared code, press the desired Mode Selection Button on the remote control. Refer to sections [Illuminated Remote Control](#) and [Programming the Illuminated Remote Control Using Access Codes](#) for details on operating peripheral equipment using the remote control.

### 4-16.3.27 Infrared Codes Index

The remote control is capable of operating many brands of peripheral equipment. Refer to previous section for programming procedures.



**NOTES:** The remote control memory is limited and therefore some models may not operate. The remote control is not designed to control all features available in all models.

After entering the proper infrared code, press the desired Mode Selection Button on the remote control. Refer to sections *Illuminated Remote Control and Programming the Illuminated Remote Control Using Access Codes* for details on operating peripheral equipment using the remote control.

#### Infrared Remote Codes for Specific Components

**Helpful Hint:** Write down the code numbers for your components in the space provided below. This will serve as a handy reference whenever you need to reprogram your remote control.

CABLE				VCR				CD			
DBS				RCVR				LD			
Other Component				Other Component				Other Component			
Other Component				Other Component				Other Component			

**Codes for VCR**

Brand	Code	Brand	Code
Admiral	335	Orion	320, 326
Aiwa	332	Panasonic	321, 322, 323, 324
Akai	314, 315, 316, 329	JC Penney	300, 305, 310, 311, 324, 339, 345
Audio Dynamic	311, 339	Pentax	300, 311, 345
Bell & Howell	305, 313	Philco	320, 323, 324, 326, 331, 343
Broksonic	320, 326	Phillips	323, 324, 331
Canon	323, 325	Pioneer	323
Citizen	306	Proscan	300, 301, 302, 323, 324, 331, 333, 345, 346
Craig	305, 306, 329	Quasar	321, 322, 323, 324
Curtis Mathes	324, 345	Radio Shack	305, 309, 324, 333, 336, 340
Daewoo	301, 324, 343	RCA	300, 301, 302, 323, 324, 331, 333, 345, 346
DBX	310, 311, 339	Realistic	305, 309, 324, 336, 340
Dimensia	345	Samsung	302, 304, 333
Emerson	303, 319, 320, 325, 326, 343	Sansui	320, 326, 339, 352
Fisher	305, 307, 308, 309, 313	Sanyo	305, 309, 313
Funai	320, 326, 334	Scott	301, 302, 304, 309, 320, 326, 338, 340, 347, 348
GE	324, 333, 345	Sears	300, 305, 306, 307, 308
Goldstar	306	Sharp	335, 336
Gradiente	334	Shintom	317
Hitachi	300, 323, 345	Signature 2000	335
Instant Replay	323, 324	Singer	317
Jensen	339	Sony	328, 329, 330
JVC	310, 311, 334, 339	Sylvania	323, 324, 331
Kenwood	306, 310, 311, 339	Tashiro	306
LXI	300, 305, 306, 307, 308, 309	Tatung	310, 311, 339
Magnavox	323, 324, 331	Teac	310, 311, 339
Marantz	310, 311, 339	Technics	321, 322, 323, 324
Marta	306	Teknika	324
Memorex	309, 324	Toshiba	301, 346
MGA	338, 340, 341, 347, 348	Vector Research	311
Minolta	300, 345	Wards	306, 309, 335, 336, 344
Mitsubishi	338, 340, 341, 347, 348	Yamaha	305, 310, 311, 339
Multitech	304, 347	Zenith	306, 344
NEC	310, 311, 334, 339		
Olympic	343, 324		
Optimus	306, 321, 328, 335		

**Codes for Personal Video Recorders**

Brand	Code	Brand	Code	Brand	Code
Panasonic Relay	100	Phillips Tivo	101	Sony Tivo	102



**Codes for DVD**

Brand	Code	Brand	Code
Denon	100	Saba	101
Ferguson	101	Samsung	110
JVC	109	Sharp	108
Mitsubishi	105	Sony	104
Nordmende	101	Technics	100
Panasonic	100	Thomson	101
Phillips	103	Toshiba	103
Pioneer	102	Yamaha	100
RCA	101	Zenith	107

**Codes for Cassette Deck**

Brand	Code	Brand	Code
Aiwa	223, 224, 225	Phillips	222
Denon	231	Pioneer	204
Fisher	203	RCA	226, 227, 228
Jensen	214	Sansui	205, 210
JVC	229, 230	Sharp	231
Kenwood	200, 207	Sony	219, 220
Marantz	202	Teac	210, 211, 215
Nakamichi	205	Technics	216, 218
Onkyo	208, 209, 213	Yamaha	201, 202
Panasonic	216, 218		

**Codes for VCR**

Brand	Code	Brand	Code
Admiral	226	Optimus	208, 218, 220, 222
Aiwa	233, 235	Panasonic	224, 225, 227
Carver	229	Phillips	229, 230
Denon	242	Pioneer	208
Emerson	239	Quasar	224, 225, 227
Fisher	205	RCA	231, 237, 238, 247
Harman/Kardon	219, 220, 221, 223	Sansui	210, 246
Hitachi	207	Sanyo	205
Jensen	234	Scott	210, 246
JVC	240, 241, 245	Sharp	242, 243
Kardon	223	Sherwood	220
Kenwood	200, 201, 211, 245	Sony	228
LXI/Sears	236	Soundesign	244
Magnovox	229, 232	Teac	212, 216, 218
Marantz	229	Technics	224, 225, 227
McIntosh	221	Victor	240, 241, 245
Nakamichi	210	Yamaha	202, 203, 204
Onkyo	214, 215		

**Codes for Receivers**

Brand	Code	Brand	Code
Admiral	120	Optimus	103, 127, 130, 131
Aiwa	125, 126	Panasonic	118, 119, 121
Denon	134, 135, 136	Phillips	123
Fisher	104	Pioneer	105, 107
Garrard	113	Quasar	118, 119, 121
Harman Kardon	115, 123	RCA	103, 105, 127, 130, 131
Jensen	129	Sansui	103, 111, 139
JVC	132, 133	Sharp	134, 137
Kenwood	100, 108	Sony	122
Magnavox	127	Soundesign	138
Marantz	124	Teac	111, 112, 113
McIntosh	116	Technics	118, 119, 121
Nakamichi	106	Victor	132, 133
Onkyo	109, 114	Yamaha	101, 102

**Codes for Cable Box**









Brand	Code	Brand	Code
ABC	124	Pulsar	105, 132
Archer	125, 132	Puser	115
Cableview	105, 132	RCA	115
Citizen	105, 122	Realistic	132
Curtis	112, 113	Regal	112, 118, 140, 141, 142, 145
Diamond	124, 125, 132	Regency	134
Eagle	129	Rembrandt	105, 132, 137
Eastern	134	Samsung	105
GC Brand	105, 132	Scientific Atlanta	111, 112, 113
Gemini	122	Simark	101, 105
General	111, 119, 120, 121, 122, 123	Sprucer	105, 110
Instrument/Jerrold	124, 125, 126, 127	Stargate	105, 132
Hamlin	112, 118, 140, 141, 142, 145	Teleview	101, 105
Hitachi	103, 124	Texscan	144
Macom	103, 104, 105	Tocom	135
Magnavox	133	Toshiba	104
Memorex	130	Unika	125, 132
Movietime	105, 132	Universal	122, 132
Oak	102, 137, 139	Videoway	106
Panasonic	109, 110, 114	Viewstar	129, 130
Phillips	106, 107, 128, 129, 130	Zenith	100, 117
Pioneer	101, 116	Zenith/Drae Satellite	100

**Codes for DBS**

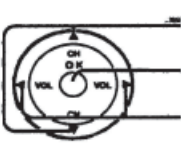
<b>Brand</b>	<b>Code</b>	<b>Brand</b>	<b>Code</b>
Dish Network (Echostar)	105, 115, 116	Panasonic	104
Echo Star	105	Phillips	101, 102
Express VU	105, 115	Proscan	106, 109, 110, 113
G.E.	106	RCA	106, 109, 110, 113
G.I. (General Instrument)	108	Sony	107
Gradiente	114	Star Choice	103, 106
Hitachi	103, 111, 112	Toshiba	100
HNS (Hughes)	103	Uniden	101, 102
Magnavox	101, 102		

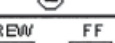
### 4-16.3.28 Mode Operational Key Chart

This chart defines which keys are operational after programming (if needed), while in the selected remote control mode TV, DTV, CABLE, DBS, VCR, DVD. . .etc.

KEY NAME	TV MODE	DTV MODE	CABLE MODE	DBS MODE
	POWER	POWER	POWER	POWER
	SAP ON/OFF	-	-	STB AUDIO TRACK
	MUTE	TV MUTE	CBL MUTE	STB MUTE
	TV ASPECT	DTV ASPECT	-	STB ASPECT
	TV INPUT SW	TV INSPUT SW	TV INSPUT SW	TV INPUT SW
	REMOTE BUTTONS	REMOTE BUTTONS	REMOTE BUTTONS	REMOTE BUTTONS
	CHANNEL UP/DOWN	NAVIGATION UP/DOWN	CABLE CHANNEL UP/DOWN	STB NAVIGATION UP/DOWN
	ACTION	ACTION	ENTER	STB ACTION
	VOL +/-	NAVIGATION RIGHT/LEFT	CABLE VOL +/-	STB NAVIGATION RIGHT/LEFT
	MENU	MENU	-	STB MENU
	DISPLAY	PROGRAM INFO.	TV DISPLAY	STB PROG. INFO
	EXIT	EXIT (EPG) ELECTRONIC PROGRAM GUIDE	-	STB EXIT
	-	STB PAGE UP/DOWN	-	STB PAGE UP/DOWN
	-	GUIDE (EPG) ELECTRONIC PROGRAM GUIDE	-	STB GUIDE
	Select Channel	Select Channel	Select Channel	Select Channel
	PREVIOUS CHAN OR VIDEO MODE	PREVIOUS STB CHAN	CABLE PREVIOUS	STB PREVIOUS
	SLEEP	DTV PROGRAM/DASH	-	STB PROGRAM/DASH
	-	-	-	-
	-	-	-	-
	-	-	-	-
	-	-	-	-
	-	-	VCR RECORD	-
	-	-	-	-
	-	-	CABLE CH CHANNEL UP/DOWN	-
	-	-	-	-

KEY NAME	DVD MODE		AUX MODE		RCVR MODE	
	VCR MODE	(DVD)	(CD)	(VCR2)		(TAPE)
	POWER	POWER	POWER	POWER	POWER	POWER
	-	-	-	-	-	-
	TV MUTE	TV MUTE	RCVR MUTE	TV MUTE	RCVR MUTE	RCVR MUTE
	-	-	-	-	-	-
	TV INPUT SW	TV INSPUT SW	-	TV INSPUT SW	TV INPUT SW	TV INPUT SW
	REMOTE BUTTONS	REMOTE BUTTONS	REMOTE BUTTONS	REMOTE BUTTONS	REMOTE BUTTONS	REMOTE BUTTONS
	TV CHAN UP/DOWN	NAVIGATION UP/DOWN	NEXT/PREVIOUS TRACK	TV CHANNEL UP/DOWN	-	TUNER +/-
	TV ACTION	SELECT	-	TV ACTION	-	-
	TV VOLUME +/-	NAVIGATION UP/DOWN	RCVR VOLUME UP/DOWN	TV VOLUME +/-	RCVR VOLUME +/-	RCVR VOLUME +/-
	-	DVD MENU	-	-	-	-
	ONSCREEN VCR DISPLAY	DVD DISPLAY	TIME FORMAT	ON SCREEN VCR DISPLAY	-	-
	-	-	-	-	-	-
	-	SKIP +/-	SKIP +/-	-	-	-
	-	TITLE	NEXT TRACK	-	-	-
	Select Channel	Select Chapter Number	Select Track Number	Select Channel	-	1... .AV1 2... .AV2 3... .AV3 4... .AV4 5... .CD 6... .TUNER 7... .PHONO 8... .TAPE 9... .AUX
	-	DVD TITLE	NEXT DISC	-	DECK A/B	-
	-	-	-	-	-	-
	VCR REW/FF	SKIP SEARCH <<REW/>>FF	SEARCH REW/FF	VCR REW/FF	TAPE REW/FF	SURROUND +/-
	PLAY	PLAY	PLAY	PLAY	PLAY	-
	PAUSE	PAUSE	PAUSE	PAUSE	PAUSE	-
	STOP	STOP	STOP	STOP	STOP	-
	VCR RECORD	-	-	VCR RECORD	TAPE RECORD	-
	TV/VCR SWITCH	-	-	TV/VCR SWITCH	-	-
	VCR CHANNEL UP/DOWN	SLOW +/-	RANDOM/REPEAT	VCR CHANNEL UP/DOWN	-	CENTER +/-
	-	OPEN/CLOSE	OPEN/CLOSE	-	OPEN/CLOSE	-

### 4-16.3.29 Troubleshooting

Before requesting service for this LCD TV, check the chart below for a possible cause of the problem you are experiencing. Some simple checks or a minor adjustment on your part may eliminate the problem and restore proper operation. If you are in doubt about some of the check points, or if the remedies indicated in the chart do not solve the problem, consult your dealer for instructions.

Symptom	Cause and Remedy	Section to Reference
Power supply does not go on	<ul style="list-style-type: none"> <li>Is power supply plug unplugged from the outlet?</li> <li>If power will not go on with the remote control, is the power supply of the TV "Off"?</li> </ul>	<p>—</p> <p>How to Connect the HDMI Terminal</p>
Remote control cannot be operated	<ul style="list-style-type: none"> <li>Is battery exhausted, or is battery polarity wrong?</li> <li>Is the remote control receiver illuminated with strong light from a fluorescent lamp etc?</li> <li>Are you using the special-purpose remote control for this equipment? (The unit will not operate with another remote control.)</li> </ul>	<p>4-16.1.14</p> <p>—</p> <p>—</p>
Image shakes, or image is unclear	<ul style="list-style-type: none"> <li>Is there deterioration, breakage or disconnection of the antenna or antenna wire?</li> <li>Is the antenna wire connected correctly?</li> </ul>	<p>—</p> <p>Connecting antenna wire</p>
There are spots on the picture, or the screen shakes	<ul style="list-style-type: none"> <li>Is the system affected (by radio wave interference or induced electromagnetic waves) by external sources (automobiles or trains, high-voltage wires, neon, motors, magnetized steel frame, or iron rain shutters, etc)?</li> </ul> <p>→ Turn off the power supply, and try changing the equipment setup location. If that has no effect, separate magnet-proofing will be required.</p>	—
The image appears doubled or tripled	<ul style="list-style-type: none"> <li>Is the antenna direction shifted?</li> <li>Are reflected electromagnetic waves being received from mountains or buildings?</li> </ul>	—
A color pattern appears, or colors disappear	<ul style="list-style-type: none"> <li>Is the equipment being affected by another TV (electromagnetic interference)?</li> </ul> <p>→ Changing the TV setup location may lead to improvement.</p>	—
The channel number disappears from the screen	<ul style="list-style-type: none"> <li>Has the RECALL button been pressed?</li> </ul> <p>→ Press the "RECALL button" again. If the system is switched to external input and there is no external signal video, the number will disappear.</p>	—
When the image is not stable, the screen turns completely white for a moment	<ul style="list-style-type: none"> <li>This occurs when the signal driving the liquid crystal is lost, and is not a malfunction.</li> </ul>	Location of Controls
The screen goes dark momentarily when the channel is changed.	<ul style="list-style-type: none"> <li>The screen is darkened for a moment to conceal noise generated when changing channels.</li> </ul>	—
The TV makes a hissing noise occasionally	<ul style="list-style-type: none"> <li>If the screen and audio are not abnormal, this sound is caused by slight expansion and contraction of the cabinet due to changes in room temperature. It has no effect on performance.</li> </ul>	—
The screen display shakes with video input	<ul style="list-style-type: none"> <li>When input is switched to "video input", this may occur if there is no signal at the video/audio input terminal.</li> </ul>	—
A black band appears momentarily when selecting channels with video	<ul style="list-style-type: none"> <li>This is due to noise generated when changing channels.</li> </ul>	How to connect input terminals
Both edges of the screen, or columns or window frames, appear bent	<ul style="list-style-type: none"> <li>They may appear bent due to the received channel or some DVD software. This is not a malfunction.</li> </ul>	—
The image from the connected equipment does not appear	<ul style="list-style-type: none"> <li>Are plugs securely inserted into each terminal?</li> </ul> <p>→ Securely insert plugs all the way.</p>	How to connect input terminals
The main unit is hot to the touch	<ul style="list-style-type: none"> <li>The main unit radiates heat, so some parts of the console reach a high temperature. This is not a problem for performance or quality.</li> <li>Set up at a location with good ventilation. Do not cover the ventilation holes of the console with a tablecloth, etc., and do not place on top of other equipment (like a video deck).</li> </ul>	—

## Troubleshooting Continued

Symptom		Cause and Remedy	Section to Reference
H D M I	Poor Video (Example: Snow noise, no picture, picture runs, etc.)	<ul style="list-style-type: none"> <li>• Check HDMI cable is connected securely.</li> <li>• Turn the power supply of the TV set and connected equipment ON/OFF.</li> <li>• Check compatibility of connected signal. Change settings of connected equipment to make signal compatible.</li> <li>• Is the input source from the equipment that is EIA/CEA-861/861B compliant consumer electric device?</li> </ul>	12
	Poor Audio	<ul style="list-style-type: none"> <li>• Set audio of connected equipment to L.PCM.</li> <li>• Check setting of HDMI INPUT under AUDIO ADJUST.</li> <li>• If the problem with the digital audio connection persists, change to an analog audio connection.</li> </ul>	24

### 4-16.3 Panasonic 20" Television

This system is installed in the bedroom area. Basic operating instructions can be found in this section.

#### 4-16.3.1 Power On/Off

Connecting the Plug to the Wall Outlet

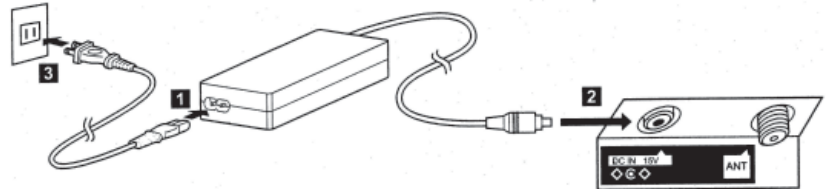

**NOTE:**

- The TV and AC adaptor will still consume some power as long as the power cord is still inserted into the wall outlet.
- Be sure to use the power cord and AC adaptor included in the accessories.
- Usage of AC adaptors other than specified may cause malfunctions.

#### 4-16.3.2 How to Turn the Power On

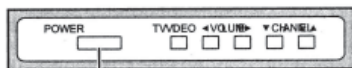

Main Power switch

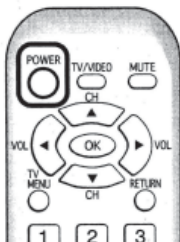
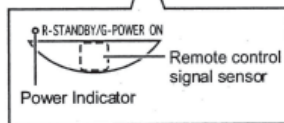

Press the Main POWER switch on the tv to turn the set on. POWER-ON: Green

When the set is on or in standby mode press the Main POWER switch on the TV to turn the set off.

POWER-OFF: No light

**Example: The screen below is displayed for a while after the TV is turned on. (Setting condition is an example.)**

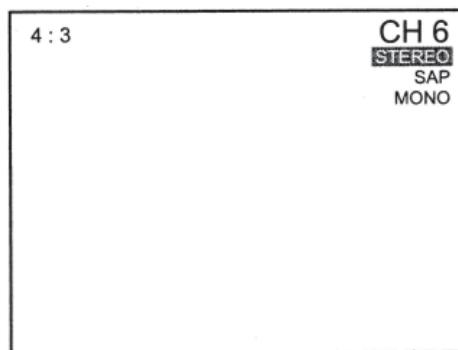

Press the POWER button on the remote control to turn the TV off: Red (standby)

Press the POWER button on the remote control to turn the TV on: Green

### 4-16.3.3 How to Connect the Input Terminals

Connect VCR and other peripheral equipment

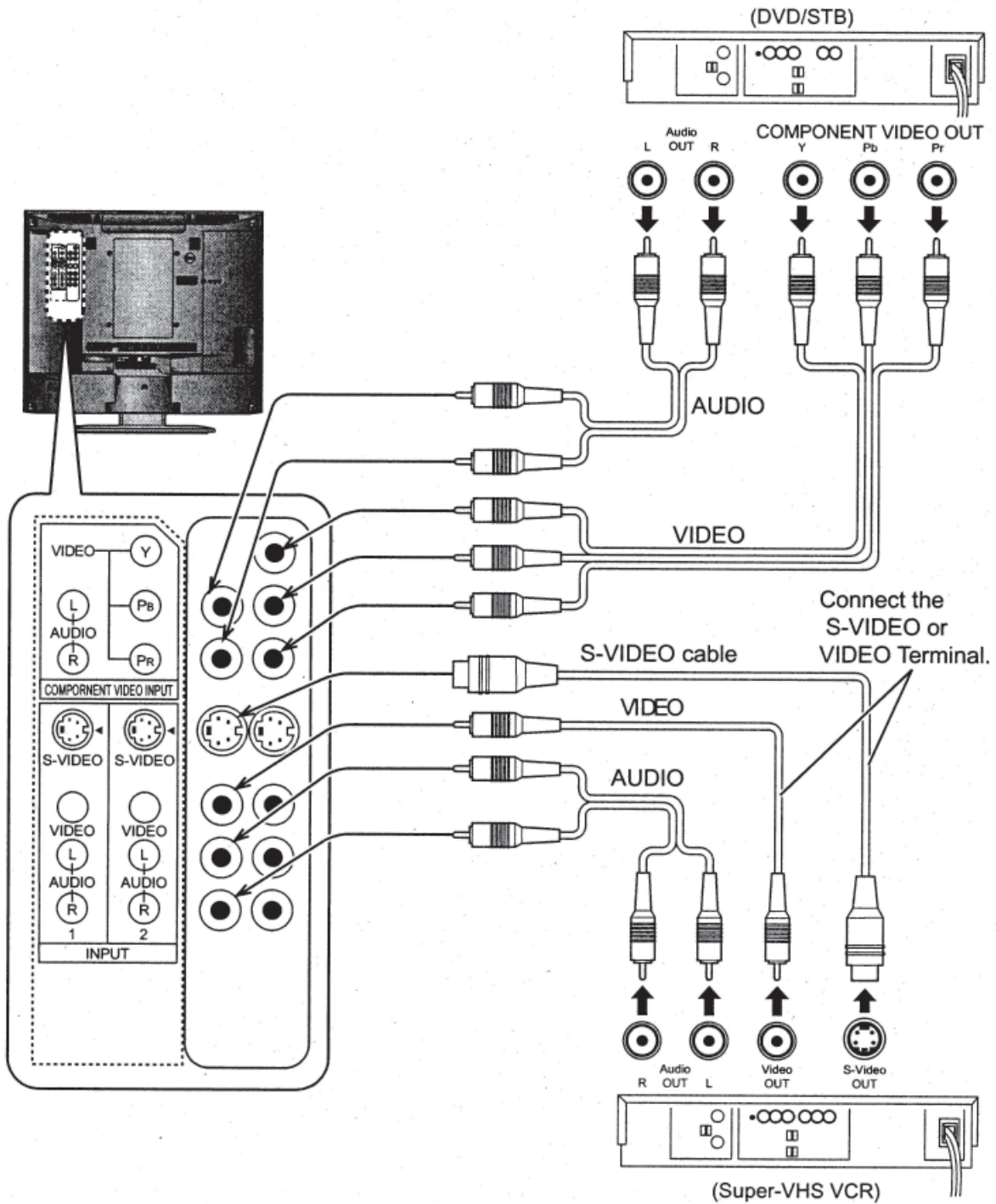



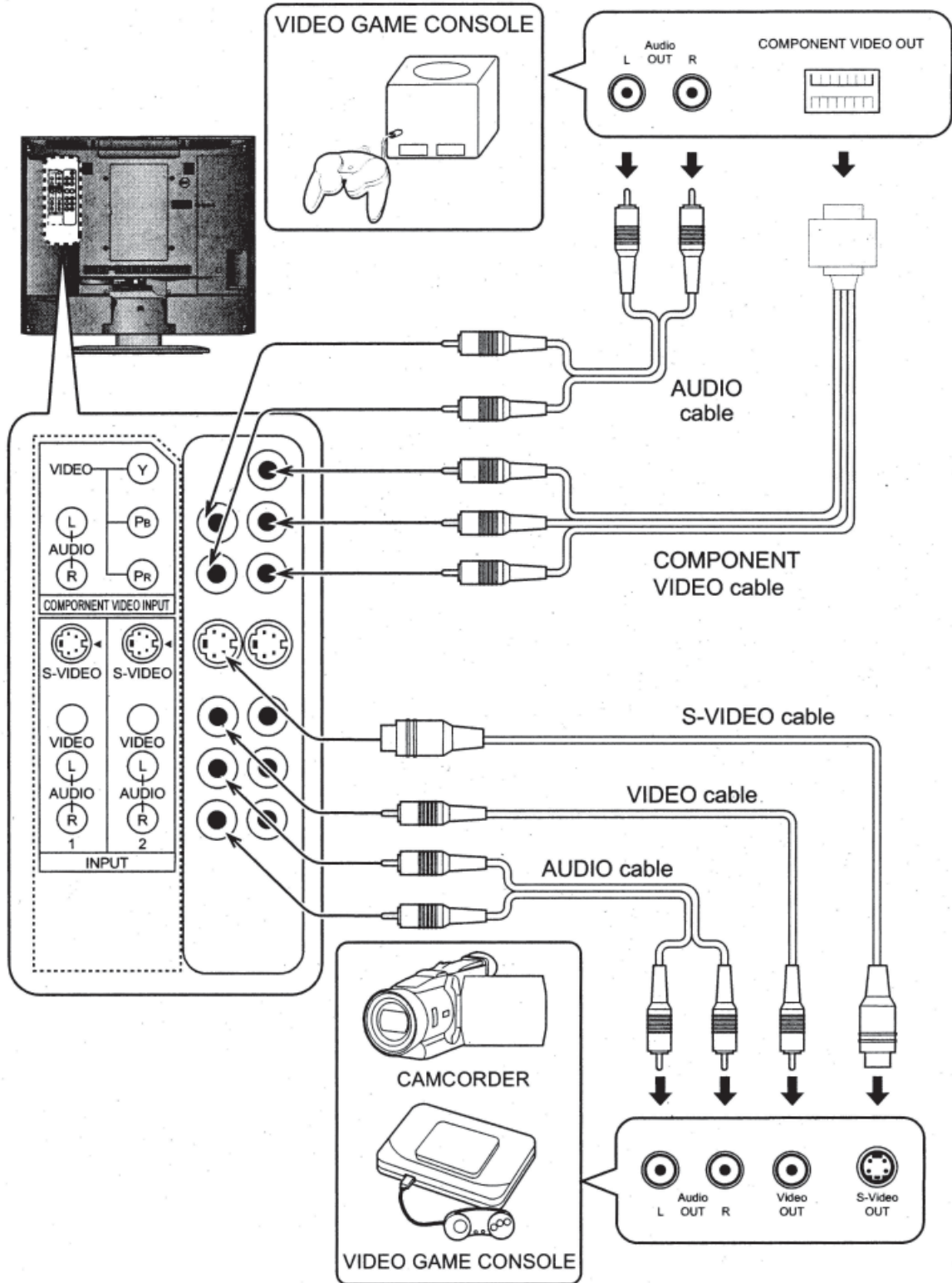

### 4-16.3.4 Playing a VCR or Other Peripheral Equipment

This equipment can also be connected to the rear terminals to play a Camcorder, VCR, Laser Disc Player or a DVD Player.

Make sure that the TV is in standby mode.

Connect the S-Video outputs or the Video outputs per illustration at right

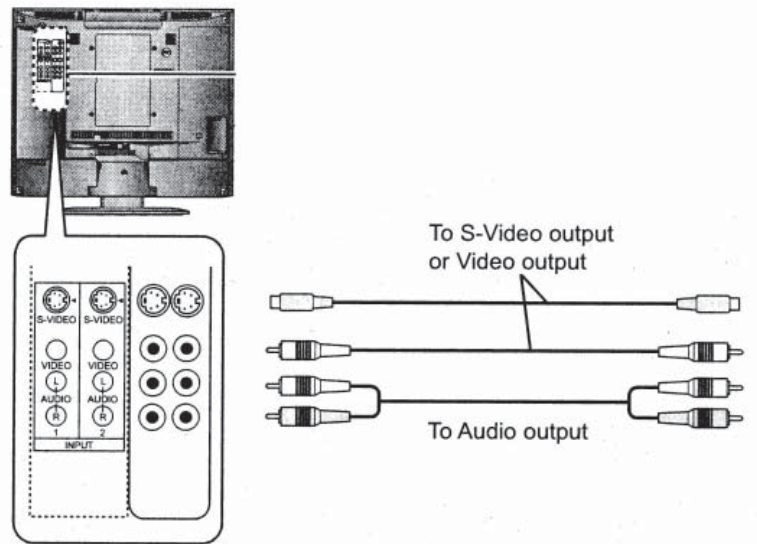

Turning the power on and switching input modes.

1. Turn the TV on by pressing Power button on remote.
2. Press TV/VIDEO button on remote to toggle between the different modes. For instance one press is Video 1, pressing this a second time is Video 2, this is used for playing a VCR tape, Pressing again, Component will appear. Use this to play a DVD.

**NOTE:** When the remote control is unavailable, input modes can also be switched using the TV/VIDEO button on the TV set.

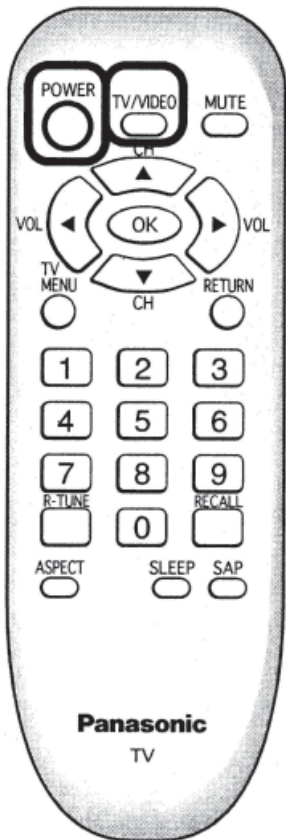

### 4-16.3.5 Basic Controls

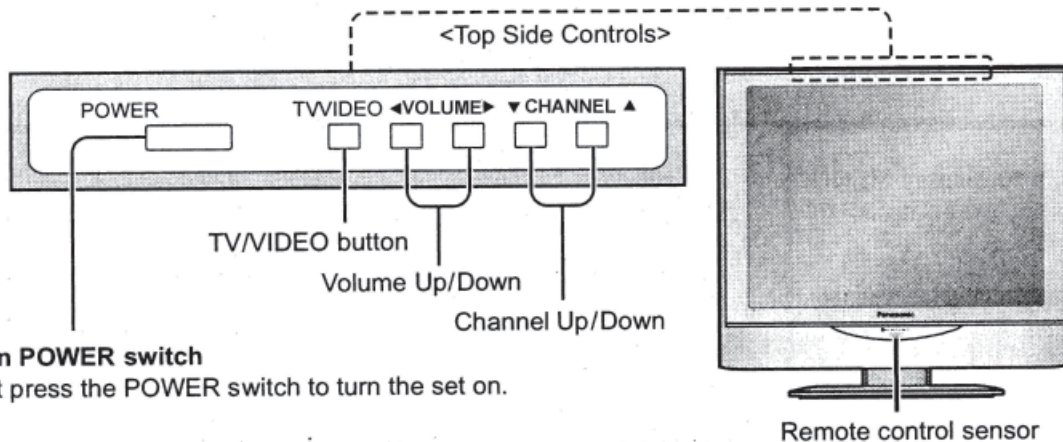

**Main POWER switch**  
First press the POWER switch to turn the set on.

**Operate your Remote control pointed to the Remote control sensor**  
(Within about 6 meters in front of the TV set.)

**Power button**  
Press to turn this set ON or OFF.  
(See page 13)  
**Note:**  
The LCD TV's power cord must first be plugged into the wall outlet and then turned on at the Main POWER switch.

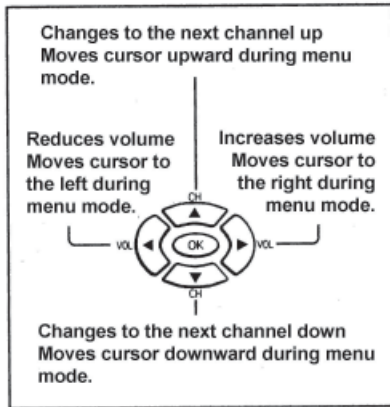

**TV/VIDEO button**  
The input mode changes each time this button is pressed.

**MUTE button**  
Press to mute the sound.  
Press again to reactivate sound.  
Sound is also reactivated when power is turned off or volume level is changed.

**RETURN button**  
Press to return to the previous screen.

**RECALL button**  
Press to display channel, sleep timer and other options.

**SAP button**  
Selects Audio mode (See page 21).  
STEREO → SAP → MONO

**SLEEP button**  
The LCD TV may be preset to switch to stand-by after a fixed period. The setting changes to 30 minutes, 60 minutes, 90 minutes and 0 minutes (SLEEP timer cancelled) each time this button is pressed.

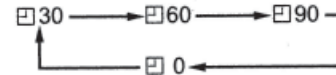

When 3 minutes remain, "3" will flash. The SLEEP timer is cancelled if a power interruption occurs. Before the timer automatically turns the power off, the remaining time will blink on the screen ("3" for 3 minutes, "2" for 2 minutes and "1" for 1 minute before the power goes off).

**MENU button**  
Press to display MENU screen, press again to clear.

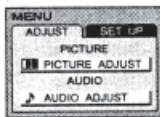

**Direct program number Selection buttons**

**R-TUNE button**  
Switches to previously viewed channel or video mode.

**ASPECT button**  
4:3 → 16:9

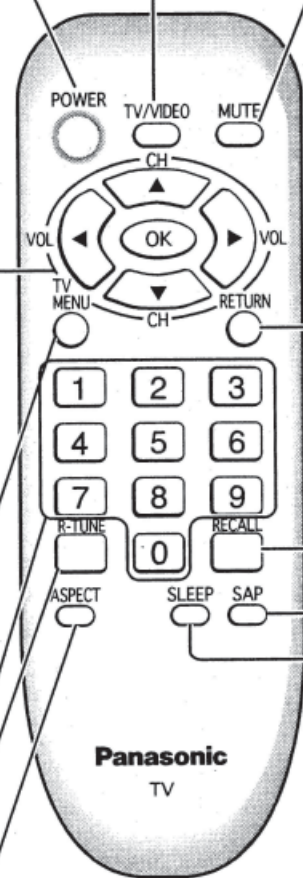

### 4-16.3.6 Remote Control Battery Installation

**Replacing the Batteries** - Replace batteries by following the steps below:

**Requires Two AA Batteries**

1. Open the battery cover.
2. Install the batteries as shown in the battery compartment. (Polarity + or - must match the markings in the compartment).
3. Replace the cover

**CAUTION!!**

**Precaution on battery use** - Incorrect installation can cause battery leakage and corrosion that will damage the remote control transmitter.

Observe the following precautions:

- Always use new batteries when replacing the old set.
- Do not attempt to charge, short-circuit, disassemble, heat or burn used batteries.
- Battery replacement is necessary when remote control acts sporadically or stops operating this unit.



**NOTES:**

- Do not drop, apply shock to or step on the remote control.
- Do not spill water on the remote control.
- Do not place objects between the remote control and remote control receiver.
- Do not use remote controls for other equipment at the same time.
- If the TV does not operate even when operating the remote control from a close range, it is time to replace the batteries.

Refer to the label on the back of the remote control for directions on replacing batteries or follow steps above.

### 4-16.3.7 Maintenance

To clean this unit, wipe with a soft, dry cloth. If the surfaces are extremely dirty, use a soft cloth dipped in a soap and water solution or a weak detergent solution.

- Use eyeglass cleaner to remove stubborn dirt from the LCD.
- Never use alcohol, paint thinner or benzene to clean this unit.
- Before using a chemically treated cloth, read the instructions that came with the cloth carefully.

**CAUTION!!**

If water or similar substances get inside the monitor via the liquid crystal panel surface, a malfunction may result.

### 4-16.3.8 Flow Chart of Menu

All adjustments and setting functions equipped in this set can be made using the menu buttons. The menu screen is composed of 2 menus, the ADJUST menu and the SET UP menu.

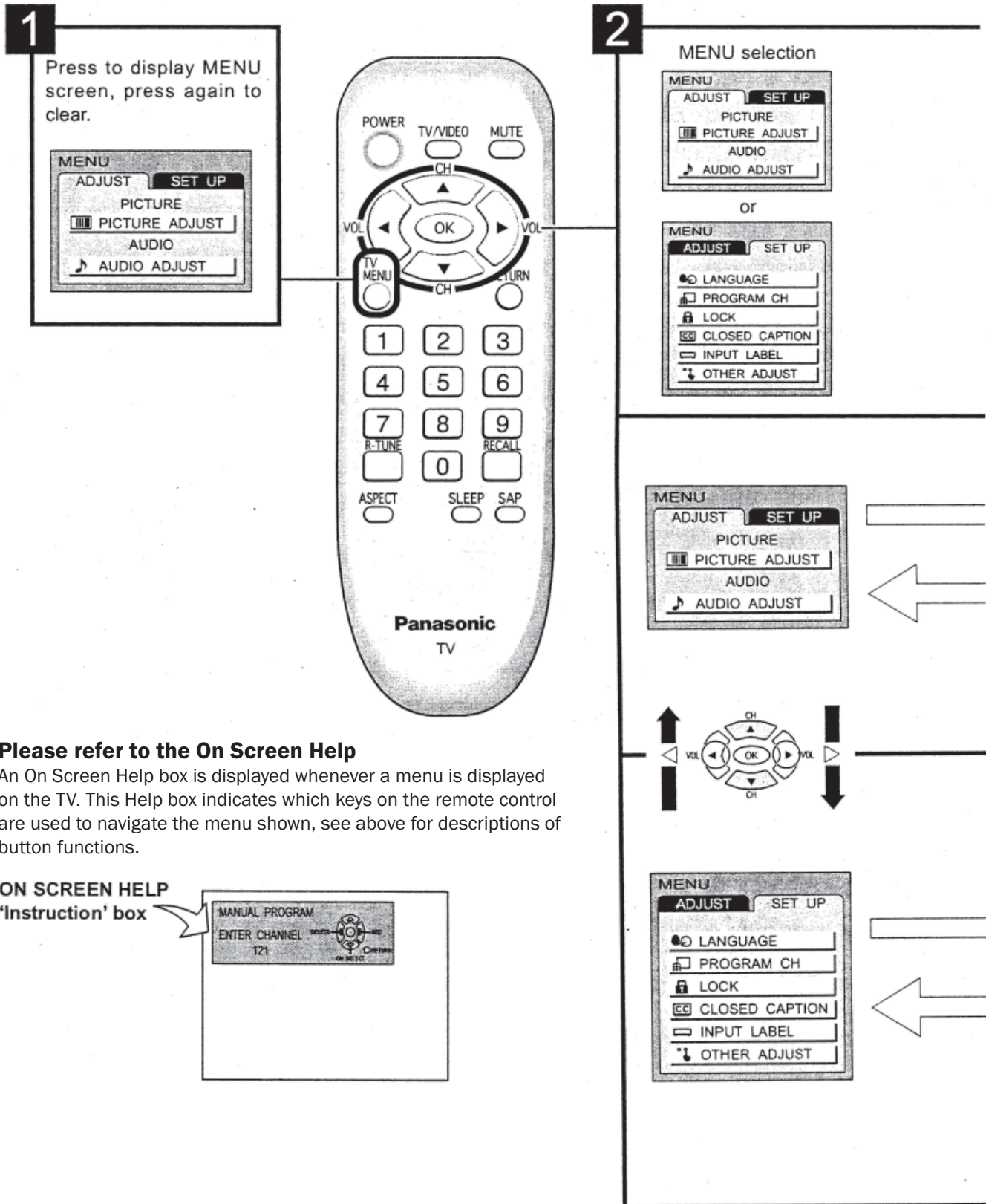

**Please refer to the On Screen Help**

An On Screen Help box is displayed whenever a menu is displayed on the TV. This Help box indicates which keys on the remote control are used to navigate the menu shown, see above for descriptions of button functions.

**ON SCREEN HELP 'Instruction' box**

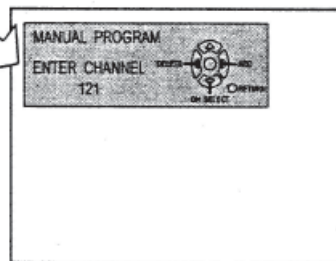

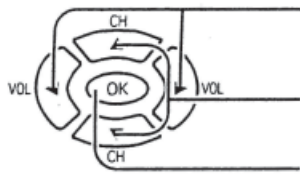

Press to select the desired MENU (ADJUST or SET UP).

Press to select each item.

Press to display each adjustment screen.



Proceed to the adjustment.

• To return to previous screen :



Press to return.

• To end adjustments :



Press to exit from the MENU screen.  
This returns the set to the normal viewing condition.

Press to display each adjustment screen.

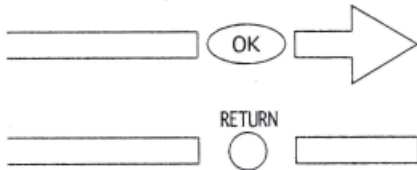

Press the RETURN button to return to previous screen.

**TO PICTURE ADJUST menu**

PICTURE ADJUST	
NORMAL	
PIC MODE	STANDARD
BACK LIGHT	+ 30
PICTURE	0
BRIGHTNESS	0
COLOR	0
TINT	0
SHARPNESS	0
AI PICTURE	OFF ON

(See page 20)

**TO AUDIO ADJUST menu**

AUDIO ADJUST	
NORMAL	
MODE	AUTO
BASS	+ 5
TREBLE	+ 2
BALANCE	0
SURROUND	OFF ON
STEREO	SAP MONO

(See page 21)

**TO LOCK selection screen**

LOCK	
BLOCK PROGRAMS:	
U. S. MOVIES	
STATUS	OFF ON
CHANGE SETTING	
ENTER CODE FIRST	

(See page 22 - 25)

Press to display each adjustment screen.

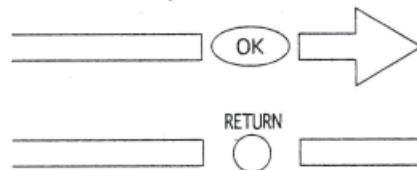

Press the RETURN button to return to previous screen.

**TO LANGUAGE**

LANGUAGE	
LANGUAGE ◀ ENGLISH ▶	
Allows you to select the language used for On Screen Displays.	
→ ENGLISH ↔ FRANÇAIS ←	
→ ESPAÑOL ←	

**TO CLOSED CAPTION**

CLOSED CAPTION	
CC ON MUTE	NO
CC MODE	OFF

(See page 26)

**TO PROGRAM CHANNELS**

PROGRAM CHANNELS	
MODE	TV CABLE
AUTO PROGRAM	
MANUAL PROGRAM	

(See page 18,19)

**TO INPUT LABEL selection screen**

INPUT LABEL	
VIDEO1	VIDEO1
VIDEO2	VIDEO2
COMPONENT	COMPONENT

(See page 27)

**TO OTHER ADJUST screen**

OTHER ADJUST	
3D Y/C FILTER	OFF ON
COLOR MATRIX	SD HD

[ for TC-17LA1 and TC-20LA1 ]

OTHER ADJUST	
COLOR MATRIX	SD HD

[ for TC-14LA1 ]

(See page 27)

### 4-16.3.9 Tuning Channels (Automatic channel programming)

Automatically scans all TV channels and stores them in memory.

**1** Turn the Power on and press the TV/VIDEO button to display the TV channel.

**2** Press the MENU button to display the MENU screen and select SET UP.

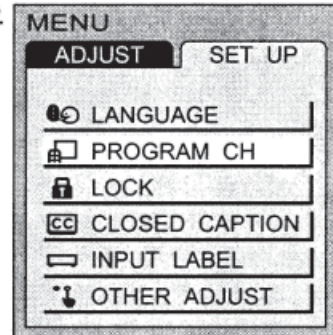
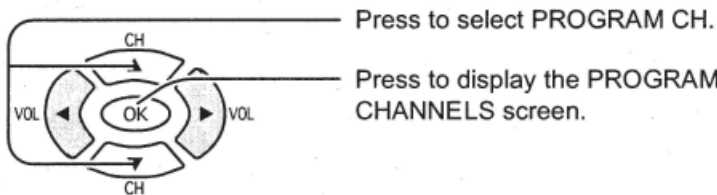

**3** Press to select MODE.

Press to select TV or CABLE.

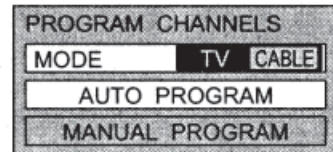
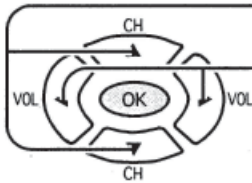

**4** Press to select AUTO PROGRAM.

Press to display the confirmation screen.

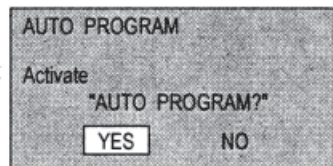
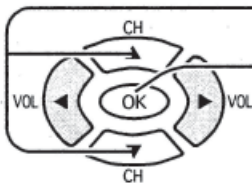

**5** Press to select YES.

Press to select NO.

If YES selection press to run AUTO PROGRAM.

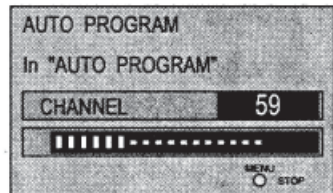
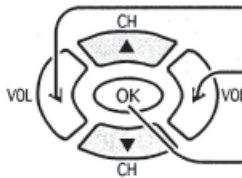

Channels will automatically advance until all channels have been scanned. Channel numbers with a video signal present will be stored in the Channel Scan Memory.



Press to exit from the MENU screen.  
This returns the set to the normal viewing condition.

#### NOTES:

- When buttons are pressed with AUTO PROGRAM running, the TV set will return to normal viewing. (Channels searched up to this point are added.)
- After AUTO PROGRAM is finished, the lowest channel number added will be received.
- When there are no receivable channels, channel 69 is displayed for TV and channel 125 is displayed for cable TV.

### 4-16.3.10 Tuning Channels (Manual channel programming)

Use this setting when changing setting of receiving channels or changing the channel display.

Turn the TV on and select the broadcast channel. Follow the steps on the previous page to display the PROGRAM CHANNELS screen.

**1**

Press to select MANUAL PROGRAM.

Press to display the MANUAL PROGRAM screen.

#### Adding or deleting channels

**2**

Press to select channel (or number keys).

**3**

Press to add channels to memory (Channel number turns blue).

Press to delete channels from memory (Channel number turns yellow).

**4** Repeat steps 2 and 3 to continue adding or deleting channels.

Press to exit from the MENU screen.  
This returns the set to the normal viewing condition.



### 4-16.3.11 Picture Adjustments

1 Press the MENU button to display the MENU screen and select ADJUST.

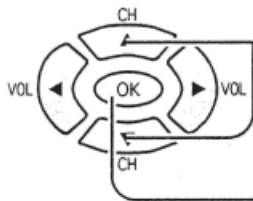

Press to select PICTURE ADJUST.

Press to display the PICTURE ADJUST screen.

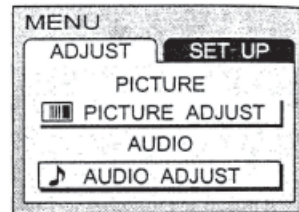

2 Press to select the menu to adjust.

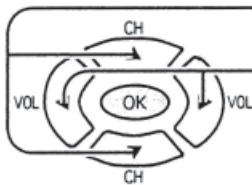

Select the desired level by looking at the picture behind the menu.

NORMAL is displayed at default.

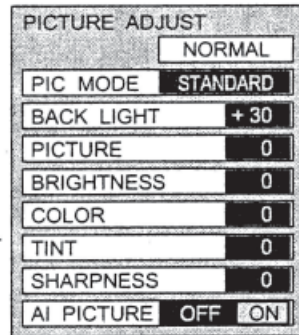

**PIC MODE** PICTURE MODE is stored for TV, VIDEO1, VIDEO2 and COMPONENT individually.

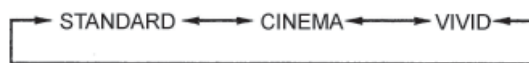

MODE	Function
<b>STANDARD</b>	Displays standard image.
<b>CINEMA</b>	Ideal for watching movings in a dark room.
<b>VIVID</b>	Displays a clear screen with contrast of light and dark.

#### BACK LIGHT, PICTURE, BRIGHTNESS, COLOR, TINT, SHARPNESS, AI PICTURE

You can change the level of each item (BACK LIGHT, PICTURE, BRIGHTNESS, COLOR, TINT, SHARPNESS and AI PICTURE) for each MENU (STANDARD, CINEMA, and VIVID) according to your personal preference.

MODE	Function
<b>BACKLIGHT</b>	Luminance of the back light is adjusted.
<b>PICTURE</b>	Selects proper brightness and density for the room.
<b>BRIGHTNESS</b>	Adjusts for easier viewing of dark pictures such as night scenes.
<b>COLOR</b>	Adjusts the level of color.
<b>TINT</b>	Adjusts for flesh tone color.
<b>SHARPNESS</b>	Adjusts the degree of sharpness.
<b>AI PICTURE</b>	Displays black and white colors more clearly when turned ON.

To reset to standard setting.

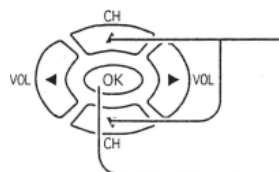

Press to Select NORMALIZE.

Press OK.

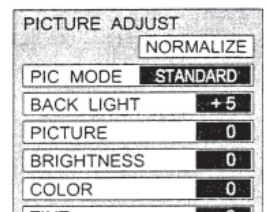

### 4-16.3.12 Audio Adjustments

1 Press the MENU button to display the MENU screen and select ADJUST.

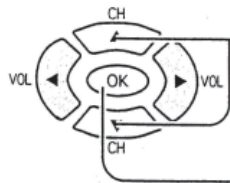

Press to select AUDIO ADJUST.

Press to display the AUDIO ADJUST screen.

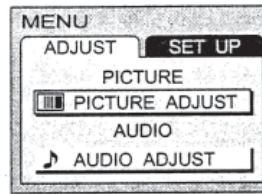

2 Press to select the menu to adjust.

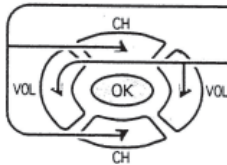

Select the desired level by listening to the sound.

NORMAL is displayed at default.

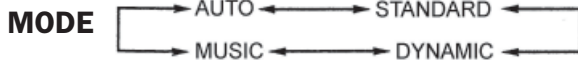
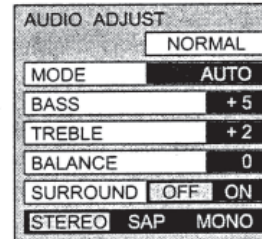

MODE	Function
<b>AUTO</b>	Automatically adjusts quiet sound and loud sound for ease of listening.
<b>STANDARD</b>	Emits the original sound.
<b>DYNAMIC</b>	Gives contrast to sound.
<b>MUSIC</b>	For programs consisting mainly of music. Enhances high sounds (around 4 kHz).

#### BASS, TREBLE, BALANCE, SURROUND

You can change the level of each item (BASS, TREBLE, BALANCE and SURROUND) for each MODE (AUTO, STANDARD, DYNAMIC and MUSIC) according to your personal preference.

MODE	Function
<b>BASE</b>	Adjusts low sounds
<b>TREBLE</b>	Adjusts high sounds
<b>BALANCE</b>	Adjusts left and right volume
<b>SURROUND</b>	To enjoy a concert hall effect, turn SURROUND to ON when stereo is playing.

#### Selecting STEREO/SAP/MONO

MODE	Function
<b>STEREO</b>	Two channel Audio reception
<b>SAP</b>	Second Audio Programming ( <i>typically used for bilingual audio.</i> )
<b>MONO</b>	Use when stereo signal is weak

#### Note:

Red display : With signal

White display : No signal

White display : MONO

To reset to standard setting: See previous section.

### 4-16.3.13 Customizing the Video Input Labels

Display for each VIDEO INPUT can be changed to match with the connected device (VCR, DVD Player, etc.).

1 Press the MENU button to display the MENU screen and select SET UP.

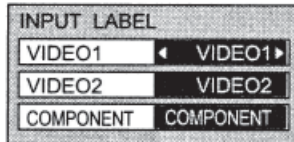
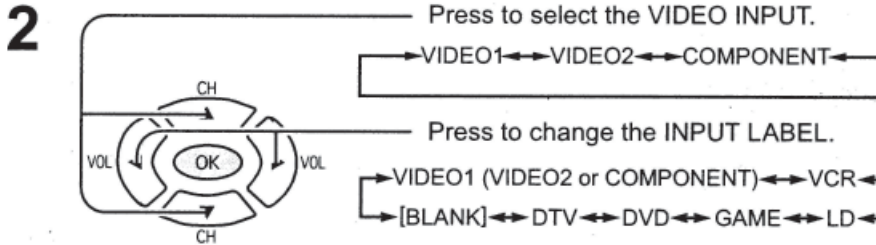
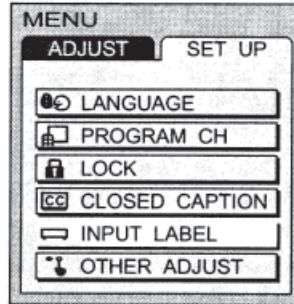
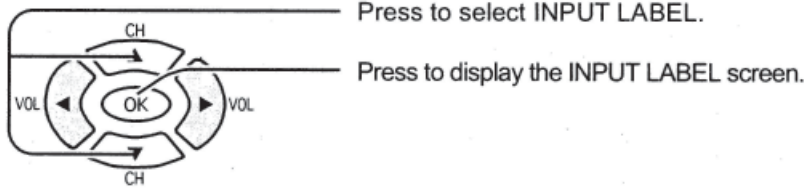

### 4-16.3.14 3D Y/C Filter/Color Matrix

1 Press the MENU button to display the MENU screen and select SET UP.

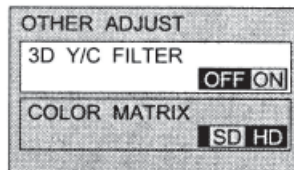
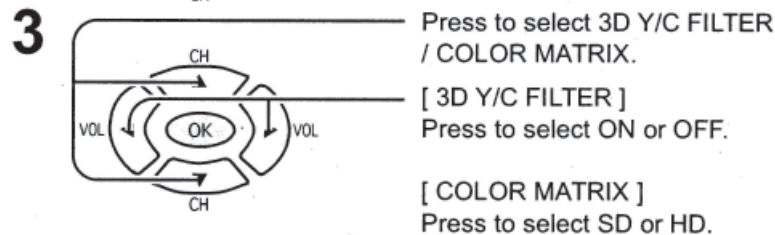
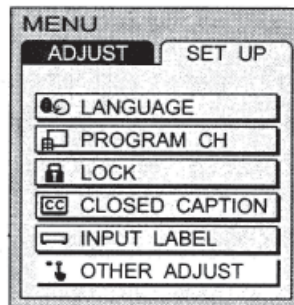
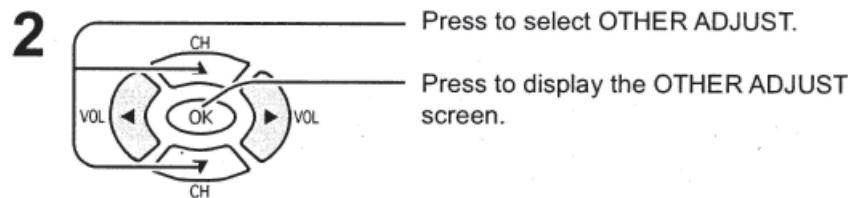

SD : When the input signal is a normal TV system (NTSC).

HD : When the input signal is a High-Definition system (ATSC).

[ for TC-17LA1 and TC-20LA1 ]

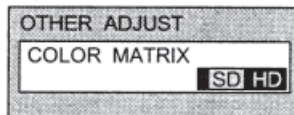

[ for TC-14LA1 ]

**NOTE:** 3D Y/C FILTER is not available for TC-14LA1.

Item	Mode	Explanation
3D Y/C FILTER [for TC-17LA1 and TC-20LA1]	ON ↔ OFF	Minimizes noise and cross color in the picture. Not available for COMPONENT VIDEO.
COLOR MATRIX	SD ↔ HD	Displays input signals (480p signals) in a natural color. Automatically adjusts color parameters for HD (high definition) and SD (standard definition).

### 4-16.3.15 Aspect Controls

The TV will allow you to enjoy viewing the picture at its maximum size, including wide screen cinema format picture.

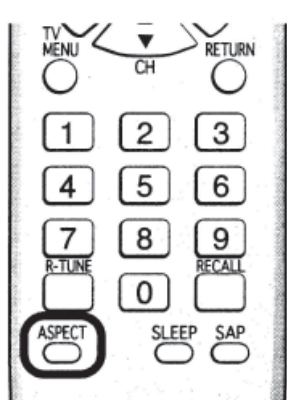

#### ASPECT Button

The aspect mode changes each time the ASPECT button is pressed.



**NOTES:**

- In TV mode, the aspect mode is set to 4:3, and ASPECT controls are not available.
- The ASPECT mode settings are stored for VIDEO1, VIDEO2 and COMPONENT individually.

Mode	Picture	Explanation
<b>4:3</b>		4:3 mode will display a 4:3 picture at its standard 4:3 size without any stretching.
<b>16:9</b>		16:9 mode will display 16:9 aspect ratio picture. Bars can be seen at the top and bottom of the image.

### 4-16.3.16 Troubleshooting

Before requesting service for this LCD TV, check the chart below for a possible cause of the problem you are experiencing. Some simple checks or a minor adjustment on your part may eliminate the problem and restore proper operation. If you are in doubt about some of the check points, or if the remedies indicated in the chart do not solve the problem, consult your dealer for instructions.

#### Troubleshooting Chart

Symptom	Cause and Possible Remedy	Reference Section
Power supply does not go on	Is power supply plug unplugged from the outlet? If power will not go on with the remote control, is the power supply of the TV "off"?	- Power On/Off
Remote control cannot be operated	Is battery exhausted, or is battery polarity wrong? Is the remote control receiver illuminated with strong light from a fluorescent lamp, etc.? Are you using the special-purpose remote control for this equipment? (The unit will not operate with another remote control.)	Remote Control Battery Installation - -
Image shakes, or image is unclear	Is there deterioration, breakage or disconnection of the antenna or antenna wire? Is this antenna wire connected correctly?	- Antenna/Cable Connection

**Troubleshooting Chart - Continued**

<b>Symptom</b>	<b>Cause and Possible Remedy</b>	<b>Reference Section</b>
There are spots on the picture, or the screen shakes	Is the system affected (by radio wave interference or induced electromagnetic waves) by external sources (automobiles or trains, high-voltage wires, neon, motors, magnetized steel frame, or iron rain shutters, etc.)?  ▶ Turn off the power supply, and try changing the equipment setup location. If that has no effect, separate magnet-proofing will be required.	-
The image appears doubled or tripled	Is the antenna direction shifted?  Are reflected electromagnetic waves being received from mountains or buildings?	-
A color pattern appears, or colors disappear	Is the equipment being affected by another TV (electromagnetic interference)?  ▶ Changing the TV setup location may lead to improvement.	-
The channel number disappears from the screen	Has the RECALL button been pressed?  ▶ Press the "RECALL button" again.  If the system is switched to external input and there is no external signal video, the number will disappear.	Basic Controls
When the image is not stable, the screen turns completely white for a moment	This occurs when the signal driving the liquid crystal is lost, and is not a malfunction.	-
The screen goes dark momentarily when the channel is changed.	The screen is darkened for a moment to conceal noise generated when changing channels.	-
The TV makes a hissing noise occasionally	If the screen and audio are not abnormal, this sound is caused by slight expansion and contraction of the cabinet due to changes in room temperature. It has no effect on performance.	-
The screen display shakes with video input	When input is switched to "video input", this may occur if there is no signal at the video/audio input terminal.	How to Connect the Input Terminals
A black band appears momentarily when selecting channels with video	This is due to noise generated when changing channels.	-
Both edges of the screen, or columns or window frames, appear bent	They may appear bent due to the received channel or some DVD software. This is not a malfunction.	-
The image from the connected equipment does not appear	Are plugs securely inserted into each terminal?  ▶ Securely insert plugs all the way.	How to Connect the Input Terminals
The main unit is hot to the touch	The main unit radiates heat, so some parts of the console reach a high temperature. This is not a problem for performance or quality.  Set up at a location with good ventilation. Do not cover the ventilation holes of the console with a tablecloth, etc., and do not place on top of other equipment (like a video deck).	-

4-16.3.19 Specifications

	TC-14LA1	TC-17LA1	TC-20LA1
<b>Power Source</b>	AC 120 V, 60 Hz		
<b>Power Consumption</b>	Average use: 48W Stand-by condition: 0.6W TV set DC 15 V, 2.8 A max.	Average use: 60W Stand-by condition: 0.8W TV set DC 15 V, 3.6 A max.	Average use: 67W Stand-by condition: 0.8W TV set DC 15 V, 3.8 A max.
<b>LCD</b>	14-inch (356 mm), 4 : 3 aspect ratio LCD panel	17-inch (432 mm), 4 : 3 aspect ratio LCD panel	20-inch (510 mm), 4 : 3 aspect ratio LCD panel
<b>Screen Size</b>	11.23" (285.1 mm) (W) x 8.42" (213.8 mm) (H)	13.53" (343.7 mm) (W) x 10.30" (261.6 mm) (H)	16.06" (408.0 mm) (W) x 12.05" (306.0 mm) (H)
<b>Channel Capability</b>	VHF-12 : UHF-56 : Cable - 125		
<b>Sound</b>			
<b>Speaker</b>	∅ 4 cm, 2pcs, 16Ω		
<b>Headphones</b>	M3 (3.5 mm) Jack x 1		
<b>Features</b>	-----	3D Y/C Digital Comb Filter	
	CLOSED CAPTION	V-Chip	
<b>Operating Conditions</b>	Temperature: 41°F - 95°F (5°C - 35°C) Humidity: 5% - 90% RH (non-condensing)		
<b>Connection Terminals</b>			
<b>INPUT</b>	VIDEO (RCA PIN Type x 1) x 2	1.0 Vp-p (75 Ω)	
	S-VIDEO (MINI DIN 4 pin x 1) x 2	Y : 1 Vp-p (75 Ω), C : 0.286 Vp-p (75 Ω)	
	AUDIO L-R (RCA PIN Type x 2) x 2	0.5 Vrms	
<b>COMPONENT VIDEO INPUT</b>	Y	1.0 Vp-p (including synchronization)	
	P <sub>B</sub> /P <sub>R</sub>	±0.35 Vp-p	
	AUDIO L-R (RCA PIN Type x 2) x 2	0.5 Vrms	
<b>Dimensions (WxHxD)</b>			
<b>Including TV Stand</b>	14.37" (365 mm) x	16.69" (424 mm) x	19.45" (494 mm) x
	14.34" (364.2 mm) x	16.35" (415.2 mm) x	18.17" (461.4 mm) x
	8.46" (215 mm)	8.46" (215 mm)	10.04" (255 mm)
<b>TV Set Only</b>	14.37" (365 mm) x	16.69" (424 mm) x	19.45" (494 mm) x
	13.01" (330.5 mm) x	15.02" (381.5 mm) x	16.63" (422.3 mm) x
	2.51" (63.7 mm)	2.52" (64.1 mm)	3.21" (81.5 mm)
<b>Mass (Weight)</b>	9.701 lb (4.4 kg) Net	11.46 lb. (5.2 kg) Net	15.87 lb. (7.2 kg) Net

 **NOTE:** Design and Specifications are subject to change without notice. Weight and Dimensions shown are approximate.

## 4-16.4 Panasonic DVD/VCR Deck

A dual DVD/VCR deck is supplied with your coach. Below you will find basic instructions for operating and maintaining your system.

### 4-16.4.1 Important Safeguards and Precautions

**FOR YOUR SAFETY, READ AND RETAIN ALL SAFETY AND OPERATING INSTRUCTIONS. HEED ALL WARNINGS IN THIS MANUAL AND ON THE UNIT.**

### 4-16.4.2 Installation

**POWER SOURCE CAUTION:** Operate only from a power source indicated on the unit or in this manual. If necessary, have your Electric Utility Service Company or Video Products Dealer verify the power source in your coach.

#### **POLARIZED OR GROUNDING PLUG**

As a safety feature, this product comes with either a polarized power cord plug (one blade is wider than the other), or a three-wire grounding type plug.

**POLARIZED PLUG CAUTION:** This plug will only fit into an outlet one way. If you cannot fully insert the plug, try reversing it. If it still will not fit, have an electrician install the proper wall outlet. Do not defeat the safety feature by tampering with the plug.

**GROUNDING PLUG CAUTION:** This plug will only fit into a three-hole grounding outlet. If necessary, have an electrician install the proper outlet. Do not defeat the safety feature by tampering with the plug.

#### **POWER CORD**

Make sure power cords are routed so that they are not likely to have anything rest on them, roll over them, or be in the way of walking traffic. If an extension cord is used, make sure it also has either a polarized or grounded plug and that the cords can be securely connected.

Frayed cords, damaged plugs, and damaged or cracked wire insulation are hazardous and should be replaced by a qualified service technician. Overloaded outlets and extension cords are fire hazards and should be avoided.

#### **DO NOT BLOCK VENTILATION HOLES**

Ventilation openings in the cabinet release heat generated during operation. If they are blocked, heat build-up inside the unit can cause failures that may result in a fire hazard or heat damage to cassettes or discs.

For protection, follow these rules:

- a. Never cover ventilation slots or the unit while in use, or operate the unit when placed on a bed, sofa, rug, or other soft surface.
- b. Avoid built-in installation, such as a book case or rack, unless proper ventilation is provided.

#### **PLACEMENT: AVOID EXTREMELY HOT LOCATIONS OR SUDDEN TEMPERATURE CHANGES**

Do not place the unit over or near heater or radiator, in direct sunlight, inside closed vehicles, in high temperatures [over 104° F (40° C)], or in over 75% humidity. If the unit is suddenly moved from a cold place to a warm one, moisture may condense in the unit and on the tape causing damage. Never subject the unit to vibration, impact, or place it so that the surface is tilted as internal parts may be seriously damaged.

#### **TO AVOID PERSONAL INJURY**

- Do not place unsecured equipment on a sloping surface.
- Do not place this unit on any support that is not firm, level, and adequately strong. The unit could fall causing serious injury to a child or adult and damage to the unit.
- An appliance and cart combination should be moved with care. Quick stops, excessive force, and uneven surfaces may cause the appliance and cart combination to overturn.
- Carefully follow all operating instructions and use the manufacturer's recommended accessories when operating this unit or connecting it to any other equipment.

### 4-16.4.3 Outdoor Antenna Installation

#### SAFE ANTENNA AND CABLE CONNECTION

If an outside antenna or cable system is connected to the equipment, be sure the antenna or cable system is grounded so as to provide some protection against built up static charges and voltage surges. Section 810 of the National Electrical Code, ANSI/NFPA 70 (in Canada, part 1 of the Canadian Electrical Code) provides information with respect to proper grounding of the mast and supporting structure, grounding of the lead-in wire to an antenna discharge unit, size of grounding conductors, location of antenna discharge unit, connection to grounding electrodes and requirements for the grounding electrode.

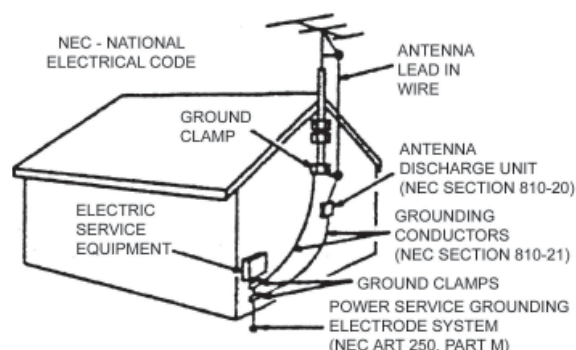

#### KEEP ANTENNA CLEAR OF HIGH VOLTAGE POWER LINES OR CIRCUITS

An outside antenna system should be located well away from power lines, electric light or power circuits and where it will never come into contact with these power sources if it should happen to fall. When installing an outside antenna, extreme care should be taken to avoid touching power lines, circuits or other power sources as this could be fatal. Because of the hazards involved, antenna installation should be left to a professional.

### 4-16.4.4 Using the Unit

If the unit has been in storage or moved to a new location, refer first to the INSTALLATION section of these safeguards.

#### KEEP THE UNIT AWAY FROM WATER OR MOISTURE OF ANY KIND.

**IF EQUIPMENT IS EXPOSED TO RAIN, MOISTURE, OR STRONG IMPACT**, unplug the unit and have it inspected by a qualified service technician before use.

#### DURING AN ELECTRICAL STORM

During a lightning storm, whether indoors or outdoors, or before leaving the unit unused for extended periods of time, disconnect all equipment from the power source as well as the antenna and cable system.

#### WHEN THE UNIT IS PLUGGED IN

- Never expose the unit to rain or water. **DO NOT OPERATE** if liquid has been spilled into the unit. Immediately unplug the unit, and have it inspected by a service technician. Fire and shock hazards can result from electrical shorts caused by liquid contact inside.
- Never drop or push any object through openings in the unit. Some internal parts carry hazardous voltages and contact can cause electric shock or fire hazard. Do not put any foreign object on the disc tray.
- Avoid placing the unit directly above or below your TV set as this may cause electrical interference. Keep all magnets away from electronic equipment.

#### USING ACCESSORIES

Use only accessories recommended by the manufacturer to avoid risk of fire, shock, or other hazards.

#### CLEANING THE UNIT

Unplug the unit. Then, use a clean, dry, chemically untreated cloth to gently remove dust or debris. **DO NOT USE** cleaning fluids, aerosols, or forced air that could over-spray, or seep into the unit and cause electrical shock. Any substance such as wax, adhesive tape, etc. may mar the cabinet surface. Exposure to greasy, humid, or dusty areas may adversely affect internal parts.



### 4-16.4.5 Service

#### DO NOT SERVICE THIS PRODUCT YOURSELF

If, after carefully following the detailed operating instructions, this product does not operate properly, do not attempt to remove covers, or make any adjustments not described in the manual. Unplug the unit and contact a qualified service technician.

#### IF REPLACEMENT PARTS ARE REQUIRED

Make sure the service technician uses only parts specified by the manufacturer, or those having the same safety characteristics as the original parts. The use of unauthorized substitutes may result in fire, electric shock, or other hazards.

#### HAVE THE SERVICE TECHNICIAN PERFORM A SAFETY CHECK

After any service or repairs to the unit, request the service technician to conduct a thorough safety check as described in the manufacturer's service literature to ensure that the unit is in safe operating condition.

### 4-16.4.6 Before Using

#### LOADING THE BATTERIES

1. Open cover.
2. Insert batteries as marked.
3. Close cover.



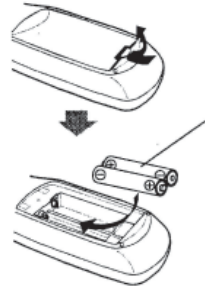

**Battery Caution:** Do not mix old and new batteries. Do not mix alkaline with manganese batteries.



#### Disc Formats Supported by This DECK

DECK can play back discs bearing any of the following marks:

**[Discs Played 8cm (3") or 12cm (5")]**

Logo	Disc Type
	DVD (DVD-Video)
	DVD-R (DVD-Video formatted discs [finalized])
	Video CD
	CD (CD-DA) CD-R/CD-RW (CD-DA, Video CD formatted discs [finalized])
	WMA, MP3, JPEG

#### Discs which cannot be played

- DVD with Region No. other than "1" or "ALL"
- DVD of PAL system, DVD-Audio, DVD-RAM, DVD-ROM, DVD-RW, DVD+RW, CD-ROM, CDV, CD-G, CVD, SVCD, SACD, Divx Video Disc and Photo-CD



#### NOTE:

- Do not use irregularly shaped discs (e.g. heart-shaped), as these can damage the unit.
- It may not be possible to play CD-R, CD-RW and DVD-R in all cases due to the type of disc or condition of the recording.

**DISC HANDLING**

- Handling Precautions
- Sticking a label on the disc may impair DVD-R playback.
- Do not attach sticker to discs. (Do not use discs with exposed adhesive from tape or left over peeled-off stickers.)
- Only hold disc by edges as shown below. Fingerprints, dirt and scratches can cause skipping and distortion.
- Do not write on label side of disc.
- Never use record cleaning sprays, benzene, thinner, static electricity prevention liquids, or any other solvent.
- Do not try to close disc tray when disc is not properly placed.



**To clean disc surface**

With a soft, damp (water only) cloth, gently wipe from the center hole to the outer edge as shown below. (Wiping in a circular pattern will scratch the surface.)

**If disc is brought from a cold to a warm environment, moisture may form on the disc**

Wipe away moisture with a soft, dry, lint-free cloth before using disc.

**Improper disc storage**

Discs could be damaged if stored or left in areas:

- Exposed to direct sunlight
- That are humid or dusty
- Near heat (i.e. heater, radiator, etc.)



**4-16.4.7 Deck and Cassette Information**

**Head Cleaning**

Playing older or damaged tapes may eventually cause video heads to become clogged.

**Video Head Clog Sensor** - During playback, this screen appears if clogging is detected. To remove screen, press PLAY on the remote or DECK.

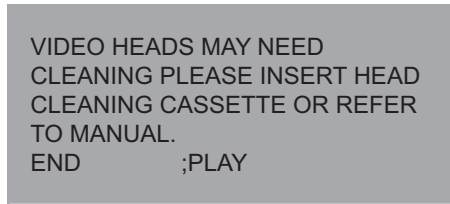

- Use “dry” type head cleaning cassette only. (Part No. NV-TCL30PT is recommended.)
- Follow cleaning tape instructions carefully. Excessive use of tape can shorten head life.
- If head clog symptoms persist, contact your nearest service center by visiting our Web Site [www.panasonic.com](http://www.panasonic.com)

**4-16.4.8 Prevent Accidental Tape Eraser**

Break off the tab to prevent recording.

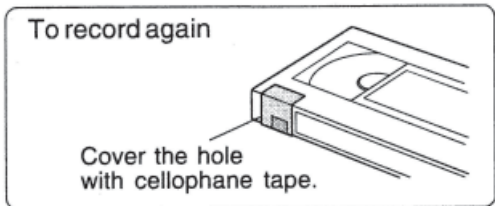
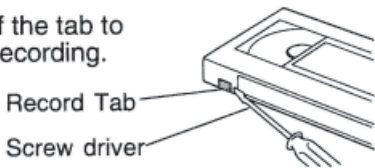

### 4-16.4.9 Record/Playback Time

Only use tapes with the **MHS** mark in this DECK.

Tape Speed Setting	Type of Video Cassette		
	T60	T120	T160
SP (Standard Play)	1 Hour	2 Hours	4 Hours 40 Minutes
LP (Long Play)	2 Hours	4 Hours	5 Hours 20 Minutes
SLP (Super Long Play)	3 Hours	6 Hours	8 Hours

### 4-16.4.10 Cleaning Deck

Use a soft cloth or dusting attachment of a vacuum cleaner to remove dust from the ventilation holes on the back sides and bottom of the cabinet. Plastic surfaces are easily scratched and can be marred by alcohol and various solvents. Avoid excessive use of oil-based furniture polishes since the materials used in the cabinet will accumulate more dust. We recommend using a non-abrasive, antistatic cleaner and polisher.

### 4-16.4.11 Features for a Quality Picture (VCR)

#### Digital Auto Picture

Automatically controls the video output signal for less noise depending on the tape condition.

#### Digital Auto Tracking

Continuously analyzes the signal and adjusts for optimum picture quality.

#### Manual Tracking Control (to reduce picture noise)

Use during Playback and Slow Motion mode to reduce picture noise. Press CH (TRACKING) ▲/▼ on the remote control or on DECK until the picture clears up. To return to Auto Tracking, press POWER off, then on again a few seconds later.

#### V-Lock Control (to reduce picture jitter)

In Still mode, CH (TRACKING) ▲/▼ operate as a V-Lock control



### 4-16.4.12 Location of Controls

**Remote Control**

**Bold:** VCR Function  
*Italic:* DVD Function  
***Bold Italic:*** VCR and DVD Functions  
 Normal: Others

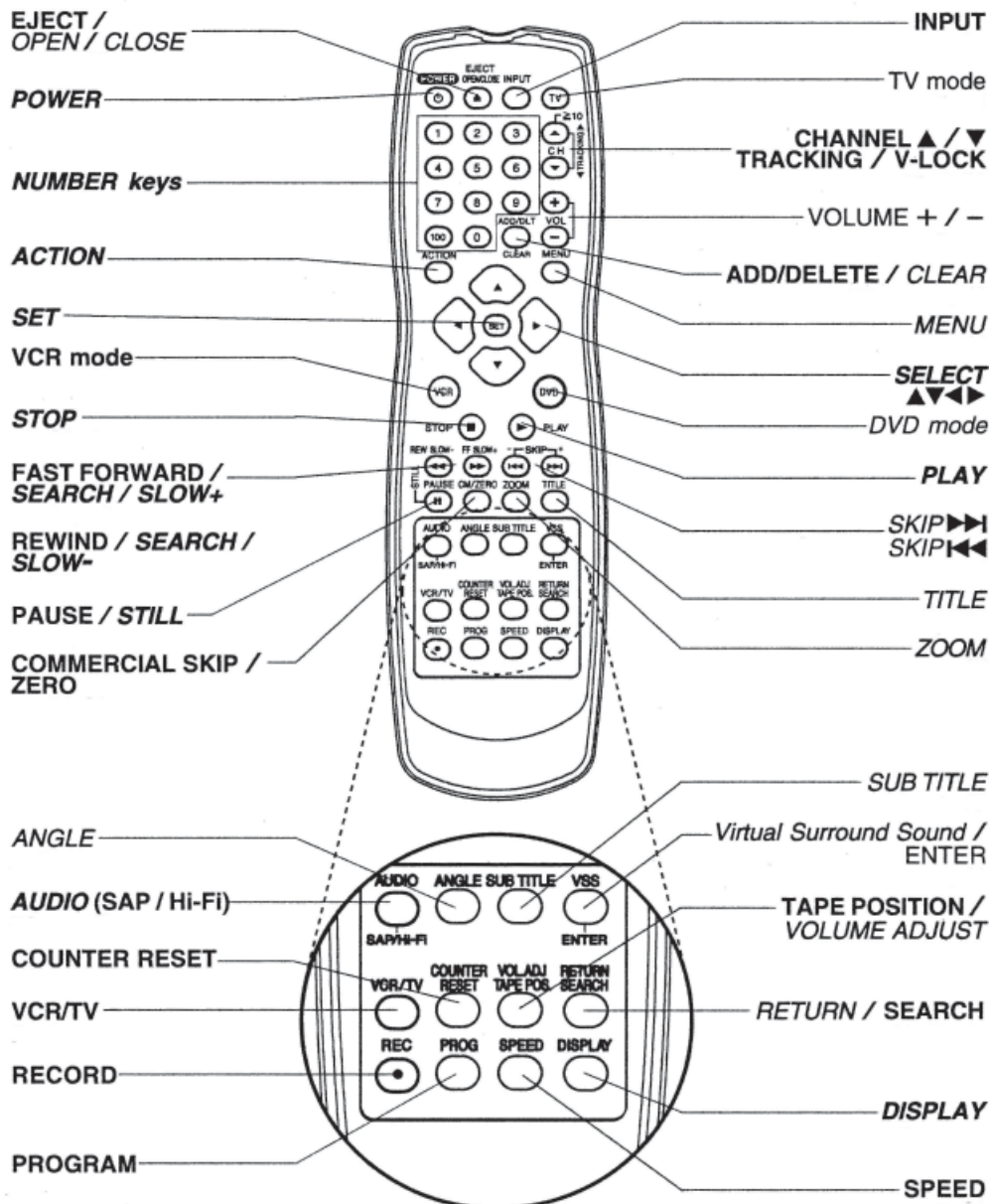

**EJECT button:** When this button is pressed in VCR mode, the tape is ejected. This button is inoperative if pressed during recording. If pressed in DVD mode, the disc tray opens or closes.

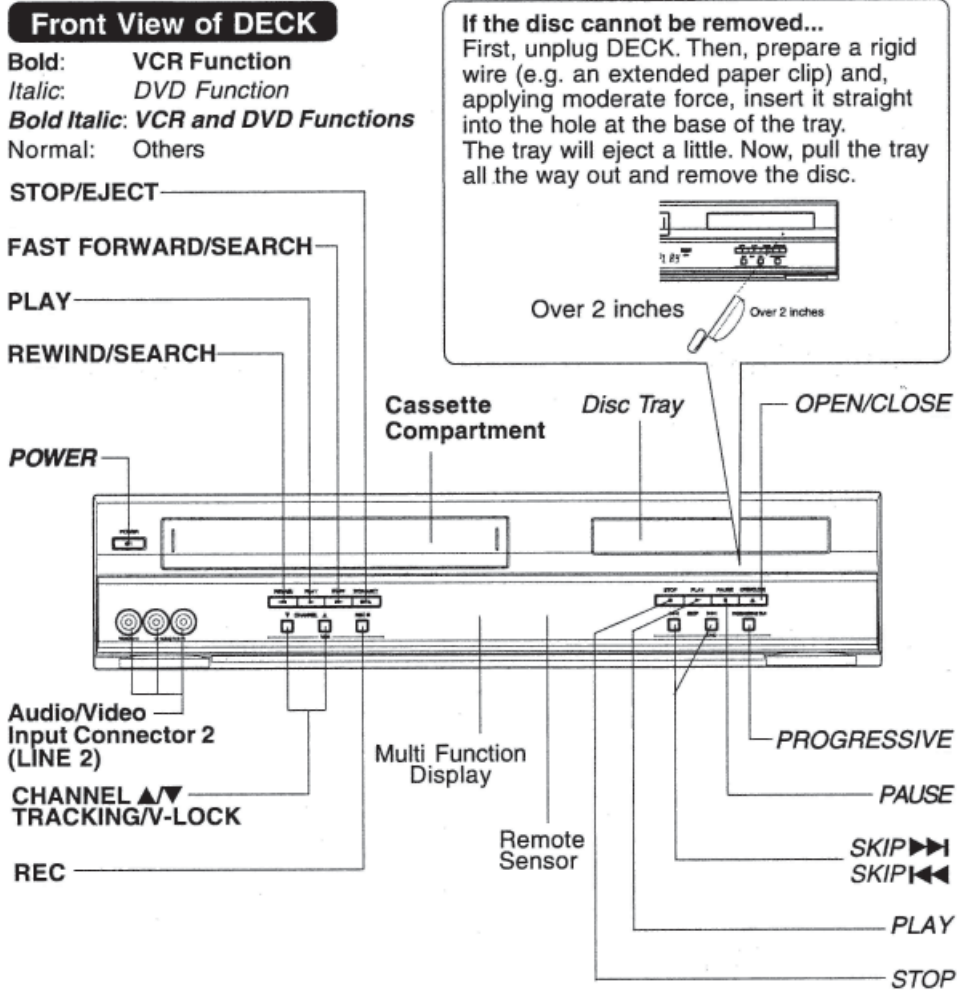

**Reset All Memory Functions**

Use when moving DECK to new location, or if a mistake was made in the Initial Setup section (return to Factory Setting).

- Make sure a tape is not inserted in the DECK.

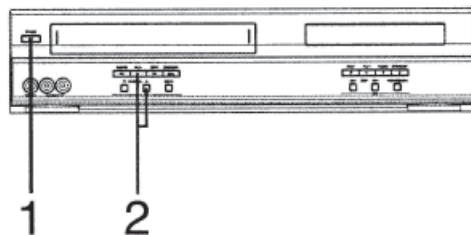

- 1 Turn DECK Power on.
- 2 Press and hold both **VCR PLAY** and **CHANNEL ▲** on the DECK for more than 5 seconds.
  - The power shuts off.
- 3 Do "Doing Initial Setup (Ready to Play)"

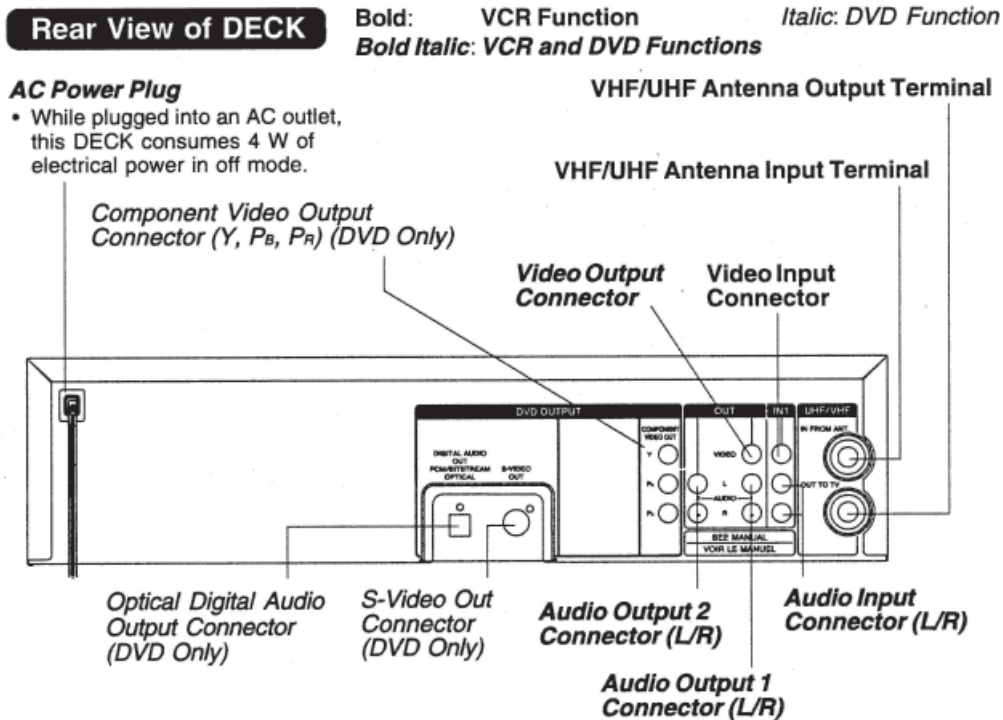

The following table shows the status of the output jacks when in VCR or DVD mode.

	<b>Video Output Audio Out 1 Audio Out 2</b>	<b>Component Video Output</b>	<b>S-Video Out</b>
VCR	YES	N/A	N/A
DVD	YES	YES	

**NOTE:** PROG functions on the remote are not available when using Component Video Output and S-VIDEO OUT. Please set TV to either RF INPUT or VIDEO INPUT, and then press PROG.

To enjoy PROGRESSIVE SCAN video

1. Connect Component Video Output to the component video input terminals of a television.
2. When the PROGRESSIVE button is pressed, the ON lamp lights up and the PROGRESSIVE SCAN signal is output from the Component Video Output Connector.

**NOTES:**

- The PROGRESSIVE button can be operated when the DECK is in DVD function mode.
- The Screen may shift off-center when using progressive output. Please adjust the screen position if this occurs.
- The DECK outputs video signals (not PROGRESSIVE SCAN) from the “VIDEO OUT” and “S-VIDEO OUT” terminals when the ON lamp is lit.

### 4-16.4.13 Displays (On Screen & Multi Function)

#### On Screen Displays (VCR)

##### Function and Channel Displays

When a function button is pressed, e.g. PLAY, or you change channels, a 5-second display appears.

##### Blank Tape/No Video Signal Indications

Whenever a blank section of a tape comes up in Play mode, or when the selected channel has no broadcast signal with Weak Signal Display Feature set to OFF, the TV screen will turn solid blue.

##### VCR Status and Clock Displays

To display or remove overlay at right,  
→ press DISPLAY.

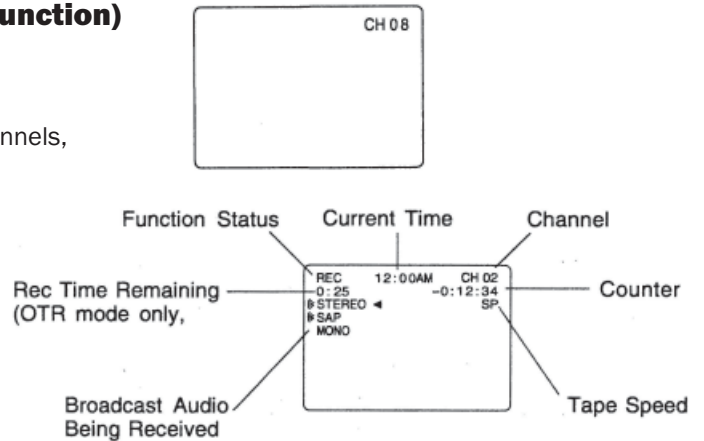

### 4-16.4.14 Multi Function Display

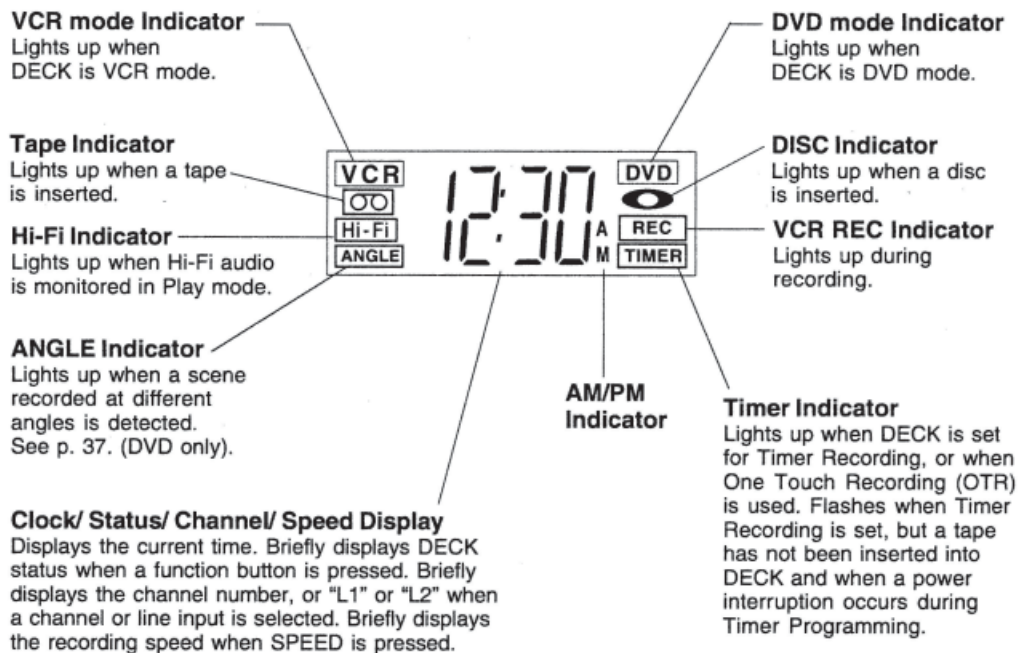

### 4-16.4.15 Connections

#### Basic Connections

- If your TV has AUDIO and VIDEO IN terminals, connect them to DECK for higher quality picture and sound.
- You can enjoy stereo sound even if your TV is not stereo by connecting a stereo amplifier to DECK.
- Connect DECK and TV with an RF Coaxial Cable (A) (supplied) or an AV Cable (B) (not supplied) as shown in the figure below.

→ DSS Receiver → DECK → TV → DECK → TV → Cable Box → DECK → TV

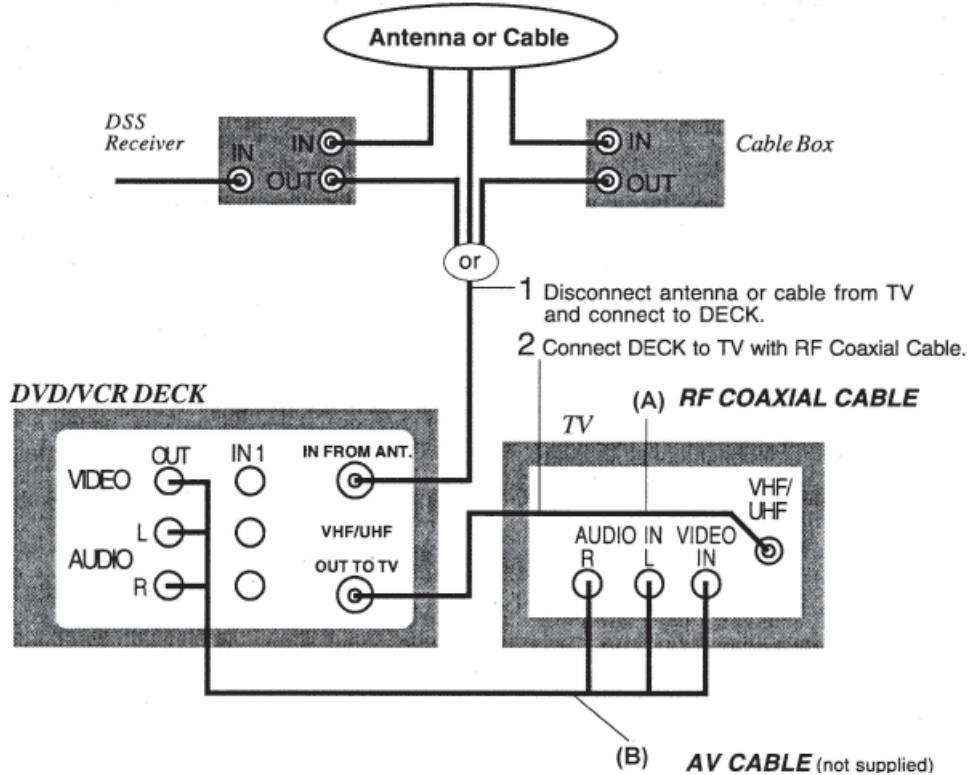

**WARNING!!** When using "Nut Type" RF coaxial cables, tighten with fingers only. Over tightening may damage terminals.

**NOTE TO CABLE SYSTEM INSTALLER** This reminder is provided to call the CABLE system installer's attention to Article 820-40 of the NEC in USA (and to the Canadian Electrical Code in Canada) that provides guidelines for proper grounding and, in particular, specifies that the cable ground shall be connected to the grounding system of the building, as close to the point of cable entry as practical.

### 4-16.4.16 Other Connections

With a Cable Box (DECK → Cable Box → TV)

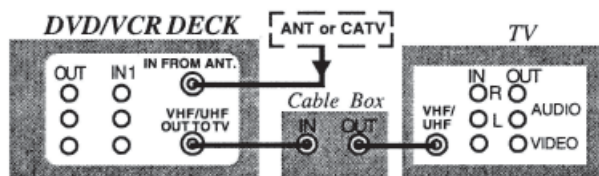

You Can	You Cannot
<ul style="list-style-type: none"> <li>• view any (including scrambled channel.)</li> <li>• use Remote Control to select channels without using Multi-brand control feature.</li> </ul>	<ul style="list-style-type: none"> <li>• record scrambled channels.</li> </ul>



**Connect with Two Cable Boxes**

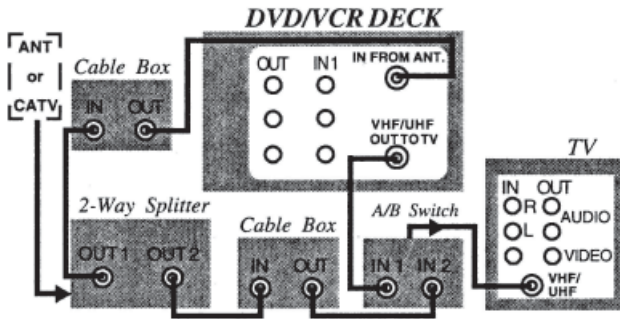

You Can	You Cannot
<ul style="list-style-type: none"> <li>record and view both scrambled and unscrambled channels if additional equipment is added.</li> </ul> <p>This connection requires: two converter boxes, and A/B switch, and a 2-way splitter.</p>	<ul style="list-style-type: none"> <li>view a channel other than the one selected for any type of recording.</li> <li>do a Timer recording of a channel unless you select it on the Cable Box.</li> </ul>

**4-16.4.17 Connections for DVD Only (enjoying higher picture quality)**

1. Connect AUDIO OUT2 (L, R) to the AUDIO IN (L,R) of the TV. (audio input for COMPONENT or S-VIDEO mode).
2. If your TV has COMPONENT VIDEO INPUT, connect to COMPONENT VIDEO OUT. If your TV does not have COMPONENT VIDEO INPUT but has S-VIDEO INPUT, connect to S-VIDEO OUT.
3. When in DVD mode, set your TV to either COMPONENT VIDEO IN or S-VIDEO IN.

**NOTES:**

- You can watch DVDs through the S-VIDEO or COMPONENT VIDEO, VHF/UHF OUT TO TV, and VIDEO OUT connections to your TV. The VCR and TUNER pictures are available only from the VIDEO OUT and VHF/UHF OUT TO TV connections to your TV.
- PROG functions on the remote are not available when using S-VIDEO OUT and COMPONENT PROGRESSIVE mode. Consult your TV operating instructions.

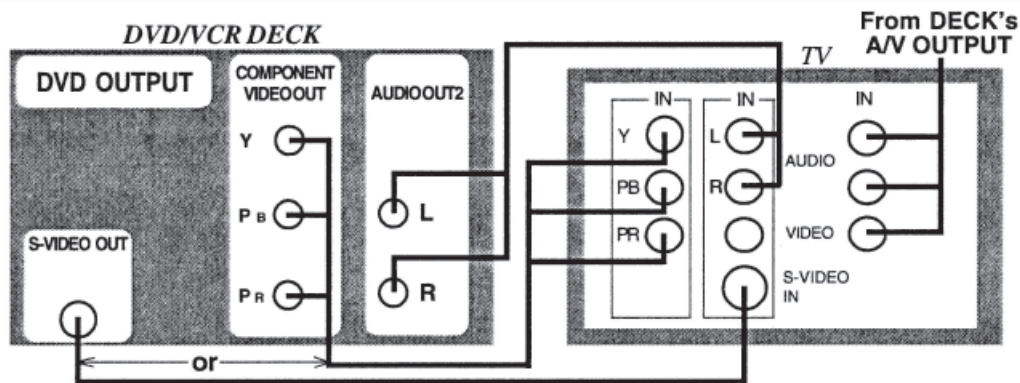

**4-16.4.18 Audio Connections**

**Ready Checklist**

- Turn down the volume, then turn DECK, as well as other equipment to be connected, off before proceeding with connection.
- Do not block ventilation holes of any of the equipment and arrange them so that air can circulate freely.
- Read through the instructions before connecting other equipment.
- Ensure that you observe the color coding when connecting audio and video cables.

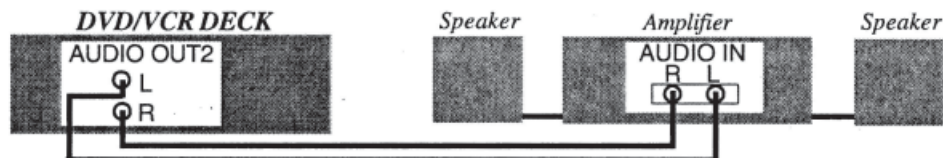
**Connecting Amplifier (2ch stereo system) [Analog connection]****Enjoying digital audio output from the digital audio output connector****Notes on audio output from the optical digital audio output connector**

Disc	Sound recording format	Optical digital audio output from connector
DVD	Dolby Digital	Dolby Digital bitstream (1-5.1 ch) or PCM (48 kHz sampling/16 bit only)* <sup>1</sup>
	Linear PCM (48/96 kHz 16/20/24 bit)	Linear PCM (2ch) (48 kHz sampling/16 bit only)* <sup>2</sup>
	DTS	Bitstream or PCM (48 kHz sampling/16 bit only)* <sup>1</sup>
Video CD	MPEG 1	PCM (44.1 kHz sampling)
CD	Linear PCM	Linear PCM (44.1 kHz sampling)
MP3	MP3	Linear PCM (it depends on the MP3 file)
WMA	WMA	Linear PCM (It depends on the WMA file)

\*1 The type of audio output from the connector can be selected by the Settings for DVD Operation.

\*2 Sound having 96 kHz sampling is converted into 48 kHz sampling when it is output from the DECK's optical digital audio output connector.

**For your reference:**

- Dolby Digital is a digital sound compression technique developed by the Dolby Laboratories Licensing Corporation. Supporting 5.1-channel surround sound, as well as stereo (2-channel) sound, this technique enables a large quantity of sound data to be efficiently recorded on a disc.
- Linear PCM is a signal recording format used in CDs. While CDs are recorded in 44.1 kHz/16 bit, DVDs are recorded in 48 kHz/16 bit up to 96 kHz/24 bit.
- If you have a Dolby Pro Logic Surround decoder, you will obtain the full benefit of Pro Logic from the same DVD movies that provide full 5.1 channel Dolby Digital soundtracks, as well as from titles with the Dolby Surround mark. For information on Panasonic or Technics Dolby Pro Logic Surround Sound Decoders please contact your local dealer.

Manufactured under license from Digital Theater Systems, Inc. US Pat. No. 5,451,942, 5,956,674, 5,974,380, 5,978,762 and other world-wide patents issued and pending. "DTS" is a registered trademark of Digital Theater Systems, Inc. Copyright 1996, 2000 Digital Theater Systems, Inc. All rights reserved.

Manufactured under license from Dolby Laboratories. "Dolby" and the double-D symbol are trademarks of Dolby Laboratories.

Connecting Amplifier (5.1 ch Surround System) [Digital Connection] DECK → Dolby Digital Decoder → Amplifier → Speaker

Or

DECK → DTS (digital theater systems) Decoder → Amplifier → Speaker

When DVDs recorded in Dolby Digital or DTS are played, Dolby Digital bitstream or DTS bitstream is output from the DECK OPTICAL digital audio output connector. When DECK is connected to a Dolby Digital decoder or DTS decoder, you can enjoy theater-quality audio in your home. [An optical digital audio cable (optional) is required when an optional Dolby Digital decoder or DTS decoder is used.]

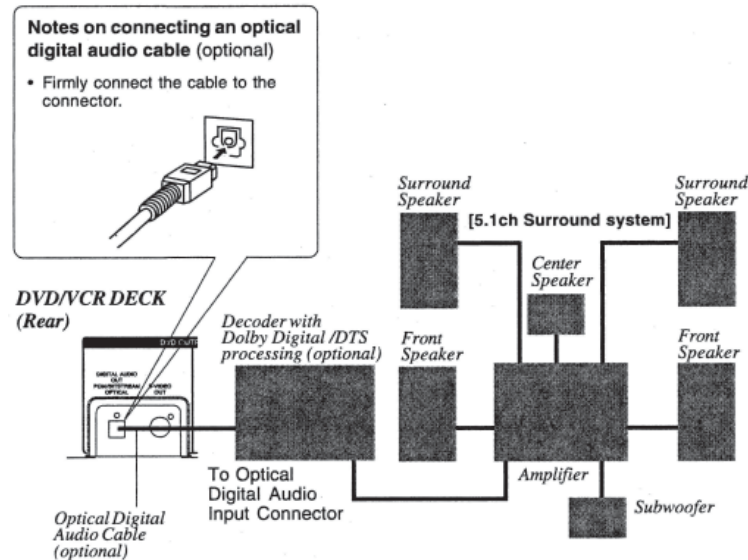

### CAUTION!!

For optical digital audio output connector:

- When connecting an amplifier (with an Optical Digital Input Connector) which does not contain the Dolby Digital or DTS decoder, be sure to select “PCM” at “Dolby Digital” and “PCM” at “dts” of the Settings for DVD Operation “AUDIO OUTPUT” Otherwise, any attempt to play DVDs may cause such a high level of noise that it may be harmful to your ears and damage your speakers.
- When a Dolby Digital/DTS decoder is connected, please select “Bitstream” at “dts” or “Dolby Digital” of the Settings for DVD Operation “AUDIO OUTPUT”. If “PCM” is selected, there will be stereo sound.
- Video CDs and CDs can be played as usual.



**NOTE:** Some DTS decoders which do not support DVD-DTS interface may not work properly with DECK.

### 4-16.4.19 Initial Setup for Basic Connections (Ready to Play)

Before Doing Initial Setup

- Turn TV on.
- See connections (A) RF Coaxial Cable Connection and (B) AV Cable Connection  
<RF Coaxial Cable Connection>  
Set TV to channel 3.  
<AV Cable Connection>  
Set TV to VIDEO
- [DECK → TV]
  - Go to “Doing Initial Setup (Ready to Play)”
 [Cable Box → DECK → TV], [DSS → DECK → TV]
  - Turn on Cable Box and set it to your Public Broadcasting Station (PBS) channel in your time zone.
  - If you use a DSS Receiver, it must be turned off.

### 4-16.4.20 Doing Initial Setup (Ready to Play)

1. Press VCR on remote for VCR mode.
2. Plug DECK Power Cord into AC wall outlet. DECK comes on and auto channel and clock set starts.
  - If screen below does not appear, check DECK-TV connection and, if TV is tuned to channel 3, try switching it to channel 4.
  - To change VCR's output channel, please refer to "VCR's Output Channel"

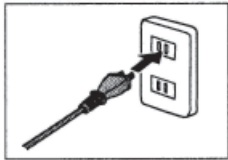

#### Plugging the AC Power Plug Into an AC Outlet



**NOTES:**

- Function buttons are inoperative during Initial Setup.
- To remove a cassette during Auto Set, press EJECT on the remote or STOP/EJECT twice on the DECK. In this case, settings must be made manually.
- Depending on conditions, Auto Clock Set may take longer than 30 minutes. If so, press STOP to stop setup and perform settings manually.



**IMPORTANT: If a remote control button does not work when pressed, press the VCR button on the remote and try the button again.**

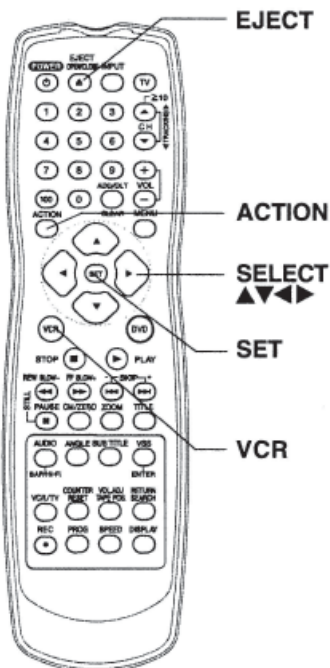

3. Settings are made automatically. When setup is done, this screen appears.

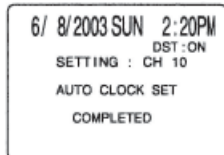

If "AUTO CLOCK SET IS INCOMPLETE" appears, manually set clock.

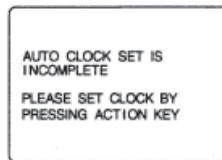

### 4-16.4.21 Manual Clock Set

If Auto Clock Set was incomplete.

1. Press ACTION\* on remote to display CLOCK screen

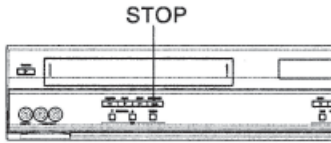
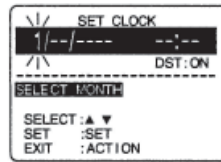

2. Press ▲▼ to select the month and SET to set. In the same manner, select and set the date, year, time, and DST (Daylight Saving Time).

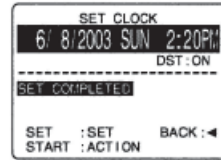

3. Press ACTION to start clock and exit.

### 4-16.4.22 Reset Language, Channels, Clock

1. Press ACTION\* to display MENU.

- PROGRAM functions are not available when using COMPONENT Video Output and S-VIDEO OUT. Please set TV to either RF INPUT or VIDEO INPUT, and then press PROGRAM.

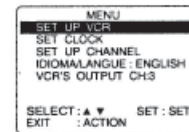

3. Channels

- 1) Press ▲▼ to select "SET UP CHANNEL," and press SET.
- 2) Press ▲▼ to select "ANTENNA," then press SET to set your antenna system ("TV" or "CABLE")
- 3) Press ▲▼ to select "AUTO SET," then press SET.
  - If you use a Cable Box, set it to the PBS channel in your time zone.

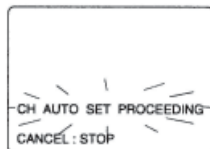

- After Channel Auto Set is finished, Auto Clock Set will be performed.

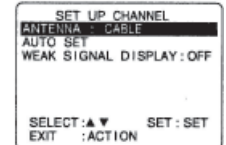
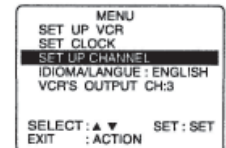

4. Clock

- 1) Press ▲▼ to select "SET CLOCK," and press SET.
- 2) Press ▲▼ to select "MANUAL," and press SET. (For Auto Clock Set, select "AUTO CLOCK SET.")

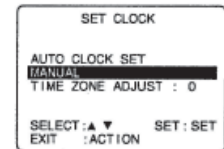

("TIME ZONE ADJUST" appears only when auto clock is set.)

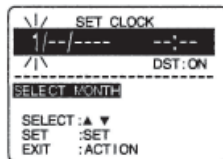
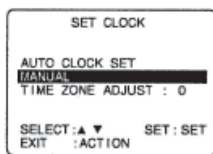

- 3) Press ▲▼ and ▲ to select, then set the date, time, and DST (Daylight Saving Time).
- 4) Press ACTION to start Clock and exit this mode.

### 4-16.4.23 VCR's Output Channel

**IMPORTANT: If a remote control button does not work when pressed, press the VCR button on the remote and try the button again.**

1. Time Zone Adjust  
(Only when Auto Clock is set.)
  - 1) Press ▲▼ to select "SET CLOCK," and press SET.

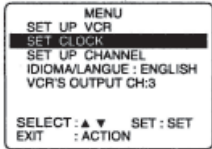

- 2) Press ▲▼ to select "TIME ZONE ADJUST," and press SET to subtract or add hour(s) as necessary.
- 3) Press ACTION twice.
  - "TIME ZONE ADJUST" returns to "0" if clock is set manually.

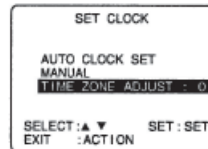

2. VCR's Output Channel
  - 1) Press ▲▼ to select "VCR'S OUTPUT CH.," and press SET.
  - 2) Press SET.

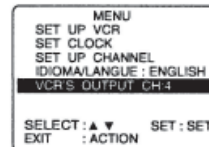

- 3) Press ACTION

↓ After 3 seconds  
To Make Corrections, repeat step 1) ~ 3).

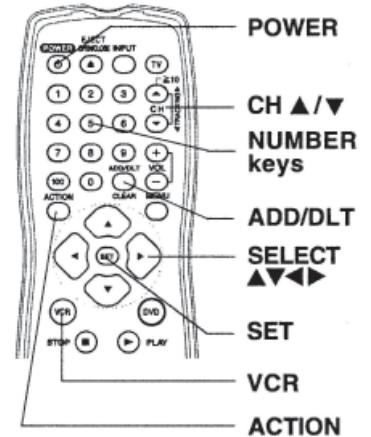
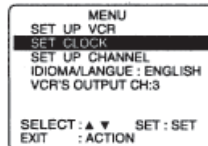
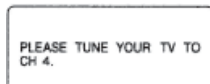
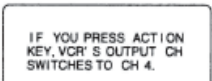

**Add or Delete a Channel**

To add channel:  
Select channel with **NUMBER** keys and press **ADD/DLT**.

CHANNEL 08 ADDED

To delete channel:  
Select channel with **CH ▲/▼** or **NUMBER** keys and press **ADD/DLT**.

CHANNEL 08 DELETED

**DST (Daylight Saving Time)**

DECK auto adjusts clock for DST. (p. 17.)

**Spring (First Sunday in April)**  
DST:ON → Sets clock ahead one hour.

**Autumn (Last Sunday in October)**  
DST:ON → Turns clock back one hour.

- If your area does not observe Daylight Saving Time, select DST:OFF.
- Keep these time changes in mind when programming DECK for timer recordings.

## 4-16.4.24 Playback/Record on a Tape

### ☑ Ready Checklist

- All connections are made.
- TV and DECK are plugged in.
- TV is on and turned to CH 3, 4 or VIDEO.
- Remote is in VCR mode. (Press VCR.)

### Playback a Tape

1. Insert a Tape.
  - Deck power comes on. If auto VCR/TV is set to "OFF," press VCR/TV on the remote to be VCR mode.
2. Press PLAY\* to play a tape.
  - If tape has no rec. tab auto play begins.

### Special Features During Play

#### Forward/Reverse Scene Search

→ Press FF/SLOW+ or REW/SLOW-.

→ Press PLAY to release.

After search has begun, each additional press of FF or REW changes speed as shown below.

[SLP] : Approx. 21X ↔ Approx. 9X

[LP] : Approx. 9X ↔ Approx. 7X

[SP] : Approx. 7X ↔ Approx. 3X

If at 21X, 9X, or 7X speed the picture is interrupted, change speed speed to 9X, 7X, or 3X.



#### NOTES:

- Picture interruption may occur with some TVs.
- FF and REW search speed may vary depending on current tape position.

#### ■ Still (Freeze) Picture

→ Press PAUSE/STILL.

→ Press PLAY to release.

#### ■ Frame by Frame Picture

→ Press PAUSE/STILL in Still mode.

→ Press PLAY to release.

#### ■ Slow Motion Picture

→ Press FF/SLOW+ (increase speed) or REW/SLOW- (decrease speed) in Still mode..

→ Press PLAY to release.

#### 3. Press STOP to stop a tape.

■ Press REW/SLOW- or FF/SLOW+ in Stop mode to rewind or fast forward a tape.

■ Press EJECT on remote, or STOP/EJECT on DECK to eject a tape.



#### NOTES:

- These features work best in SP or SLP mode.
- The sound will be muted.
- To reduce picture noise, see "[Manual Tracking Control](#)"
- After DECK is in Still or Slow mode for 3 minutes, it will switch to Stop mode automatically to protect the tape and the video head.

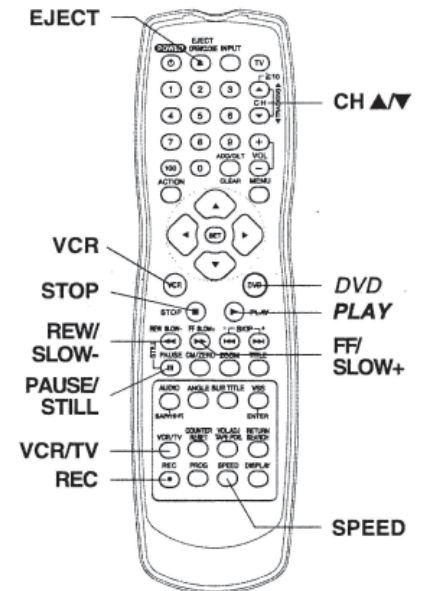

#### Playback using DECK buttons

2 Press PLAY. 1 Insert a tape.



Multi Function Display

■ Press STOP/EJECT to stop and/ or eject a tape.

**!!!IMPORTANT: If a remote control button does not work when pressed, press the VCR button on the remote and try the button again.**

## Record on a Tape

1. Insert a tape with a record tab
  - DECK power comes on. If Auto VCR/TV is set to "OFF," press VCR/TV on the remote to be VCR mode.
2. Press CH ▲▼, or NUMBER keys to select the channel.
  - For "LINE" input, see [Connection in Copying Your Tapes \(Dubbing\)](#) found later in this manual.
  - If channel is over 100, press 100 key then press the remaining 2 digits.
3. Press SPEED to select the record speed.
  - SP = Standard Play      LP = Long Play
  - SLP = Super Long Play
  - Speed appears on-screen and on Multi Function Display.
4. Press REC to start recording. (The VCR REC indicator lights up on Multi-Function Display),
  - To edit out unwanted scenes, press PAUSE/STILL to pause, and again to resume recording.
  - You cannot view another channel during recording.
5. Press STOP to stop recording
  - One Touch Recording (recording in progress),
    - Press REC repeatedly to set the recording length
    - (30 min. ~ 4 hours).
    - DECK shuts off after the preset record length.
  - Record One Station, Watch Another,
    - press VCR/TV on the remote (change to TV mode),
    - select channels at TV (recording continues).
  - Select Channels at DECK (in STOP or REC. PAUSE mode),
    - press VCR/TV on the remote (change to TV mode),
    - select channels at DECK.
  - Play a disc while recording a tape.
    - insert a disc during recording,
    - press DVD, and then press PLAY.

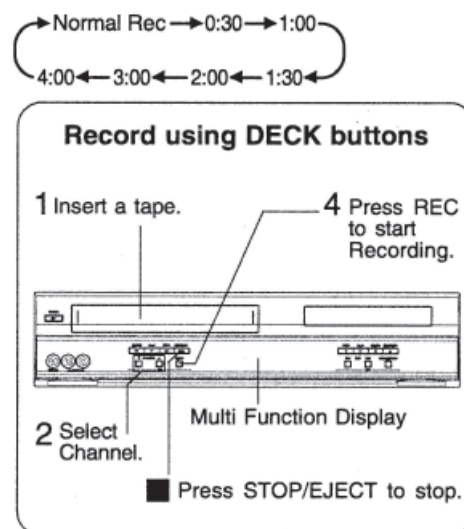

### NOTES:

- It is not possible to record from DVD/Video CD/CD to VHS tape using DECK.
- Watching one channel and recording another is not possible when using Cable Box or DSS Receiver.
- After 5 minutes in Pause mode, DECK stops to protect a tape and video heads.

This video recorder, equipped with HQ (High Quality) system, is compatible with existing VHS equipment. Only use tapes with the **VHS** mark. Only tapes tested and inspected for use in 2, 4, 6, and 8 hour machines are recommended.



**NOTE:** Remove loose or peeling labels from tapes to prevent tape jam.

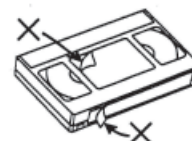



### 4-16.4.25 Basic DVD Operation

Ready Checklist

- All connections are made.
- DECK is plugged in.
- If DECK is connected to an audio amplifier, turn the stereo system's power on.

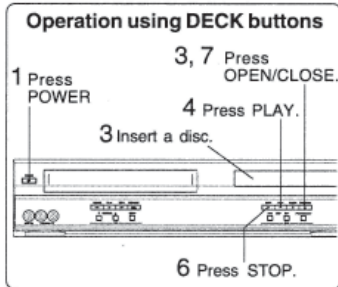

1. Press POWER\* on the remote or DECK.
2. Press DVD to select DVD mode.
  - If a disc is already inserted, go to step 4. (Depending on the disc, playback may start automatically.)
3. Press OPEN/CLOSE, and then place a disc into the disc tray.
  - Hold disc by its edge only with printed side up and use guides to place into tray. Use 1 3/8" (8 cm) or 2 5/8" (12 cm) disc.
4. Press PLAY to start playing. Disc tray closes automatically.
  - You may also close tray by pressing OPEN/CLOSE.
  - Data reading time differs with each disc.

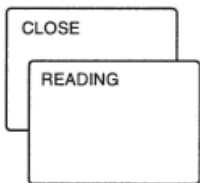
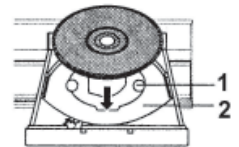
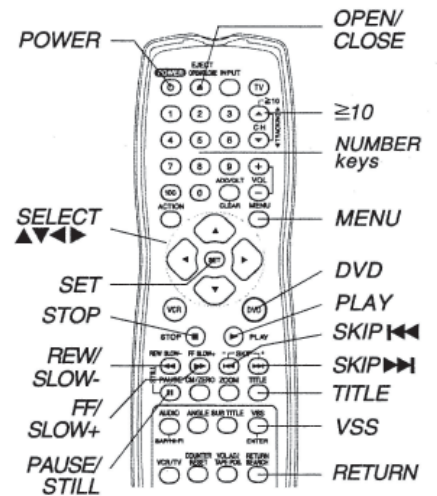

If an interactive DVD\*1 or a Video CD with playback control\*2 is used and TITLE MENU appears, go to step 5.

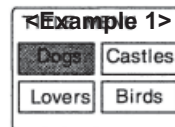

5. Press ▲▼◀▶ or NUMBER keys (see below) to select title, and press SET or PLAY to start playing.



• "Pressing SET or PLAY" is not necessary when using NUMBER keys. **Using NUMBER keys starts playing automatically.** The number of available title varies with each disc.

<Input Example>	1 digit number	1 ... 1
	2 digit number	12 ... ≥ 10 1 2
	3 digit number	123 ... 100 1 2 3

Press SKIP ▶▶| of |◀◀ to go to next or previous menu screen.

- SKIP function not available with all discs. Please refer to disc jacket for operation information.

**To return to menu (play stops)**

**Press TITLE, MENU or RETURN. (DVD)**

**Press RETURN. (Video CD)**

1. Press STOP to stop playing.
2. Press OPEN/CLOSE to eject the disc.

\*1 Interactive DVD. . .May include multiple camera angles, stores, etc.

\*2 Video CD with playback control. . .Particular scenes or information can be interactively selected from a menu that appears on the screen.

- Forward/Reverse Scene Search Press FF/SLOW+ or REW/SLOW- during play.  
Press PLAY to release.
  - Starting forward/reverse search during play started from menu on Video CDs may recall menu.
  - Search speed, slow at first, increases with each additional press of the button up to 5 levels.
- Forward/Reverse Chapter/Track Skip Press SKIP ►►| or |◄◄ SKIP during play. Each press skips a chapter (DVD) or track (Video CD/CD).
  - Pressing |◄◄ SKIP once midway through a chapter/track returns to the start of that chapter/track. Each additional press skips back one chapter/track.
  - Pressing SKIP ►►| or |◄◄ during play started from menu on Video CDs may recall menu.

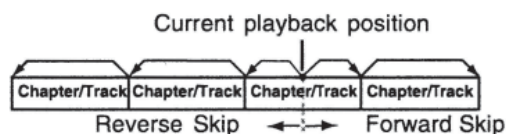

- Still Picture or Pause  
Press PAUSE/STILL during play.  
Press PLAY to release.
  - DVD/Video CD : DECK will enter still picture mode.
  - CD : DECK will enter pause mode.

- Frame by Frame Picture (DVD/Video CD)  
Press PAUSE/STILL in still mode.  
Press PLAY to release.
  - Each press advances picture one frame.
  - Hold button down for consecutive frame advance.
  - Whether pictures are advanced by "FRAME" or "FIELD" is selected automatically.

- Slow Motion Picture (DVD/Video CD)  
Press FF/SLOW+ or REW/SLOW- In still mode.  
Press PLAY to release.
  - Slow motion speed, slow at first, is increased with each additional press of the button up to 5 levels.
  - Reverse slow motion is not available for Video CDs.

#### 4-16.4.27 Auto-Power Off Function

Power turns off after DECK has been in Stop mode (DVD) for about 5 minutes.

- When ∅ appears on the screen while a button is being operated, it means that the corresponding operation is prohibited by DECK or the disc.

#### 4-16.3.28 V.S.S. (Virtual Surround Sound)

- Enjoy a surround-like effect if you are using two front speakers only. The effect is broadened and sound seems to come from virtual speakers on either side if the disc has surround signals recorded on it.
- Press VSS in DVD mode.
- The Surround sound effects can be changed by pressing VSS repeatedly as shown by the figure below.

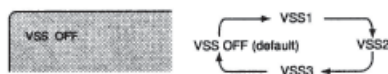

#### NOTES:

- Surround sound effects is available in DVD mode only.
- Turn off the surround effects on the other equipment.
- V.S.S. will not work, or will have less effect, with some discs.
- Turn V.S.S. off if it causes distortion.
- Surround will only come from the two front speakers if V.S.S. is on.

### 4-16.4.28 Resume Function

DECK memorizes the point where STOP is pressed (STOP ► is displayed on screen). **Press PLAY** to resume play from this point. Pressing STOP again or opening the tray cancels RESUME, however, RESUME is not canceled when power is turned off and on.

RESUME works only with discs for which elapsed play time is displayed during play.

### 4-16.4.29 Enjoy Video CDs featuring playback control without using menus (Video CDs only)

- Do steps 1-4 (Basic DVD Operation). When menu appears, press STOP.
- Press NUMBER keys to select desired track (play begins).
  - Check disc for track numbers.
  - Press "1" to start at beginning of disc.

To Resume Menu use,

**Press STOP** and **press PLAY**, then the menu will be displayed. Now, go to step 5 (Basic DVD Operation).



#### NOTES:

- Please read the disc jacket for operation information.
- If a single sided disc is placed in upside down, "THIS TYPE OF DISC CANNOT BE PLAYED. PLEASE INSERT A DIFFERENT DISC" is displayed.
- Remove disc and press DECK POWER off when not in use.
- Disc continues to rotate with menu displayed even after play is done.
- Press STOP to clear menu display when finished with menu.

### 4-16.4.30 Timer Recording

#### ✓ Ready Checklist

- All connections are made.
- TV and DECK are plugged in.
- Clock set correctly.
- Tape has rec.tab.
- Remote is in VCR mode. (Press VCR.)
- Sufficient tape remaining for recording time.

- Press PROG\* to display Program

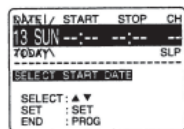

#### Example Today

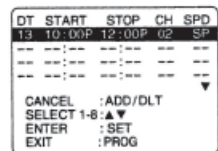
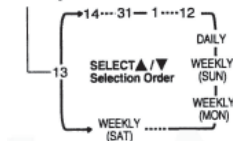

- To set record DATE, press ▲ ▼ to select: 1-31 = one time, or DAILY = MON~FRI, or WEEKLY = same time each week and press SET.
  - See selection order left.
- To set remaining items, press ▲ ▼ to select and press SET to set START/STOP times, CH (channel) or LINE input, and tape speed (SP, LP, SLP).

**Press PROG** to end programming.

- To Enter More Programs, press ▲ ▼ to select and press SET to set an unused program number, and then repeat step 2.

Or

**Press PROG to exit.**

- The "Timer" Indicator lights up on DECK.
- You can use Timer Recording with the power on or off.
- "TIMER REC WILL START SOON" appears on-screen for 2 minutes before Timer Recording starts. If DECK is in DVD mode, no message appears, but the VCR REC Indicator, the VCR mode indicator and "REC" will flash on Multi Function Display.

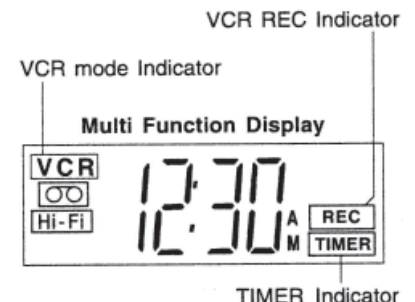
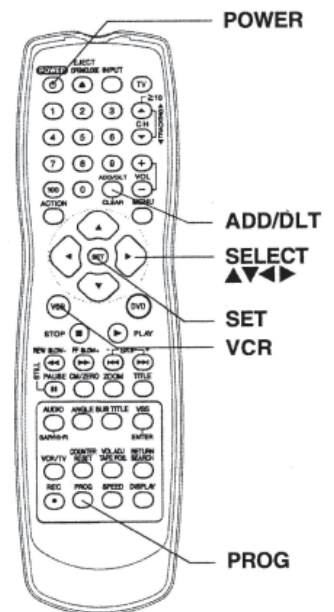

### 4-16.4.31 Review, Replace or Clear Program Contents:

(Recording is not in progress)

1. Press PROG to display Program List.

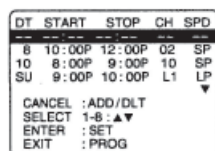

2. Press ▲▼ to select number and press SET to display.

**3. To Replace program.** . . Repeat Step 2 (previous section) to set new programs.

**Or**

**To Clear Program. . . Press ADD/DLT.**

**4. Press PROG** to end the programming.

#### To Cancel a Timer

##### Recording in Progress. . .

Hold down STOP in VCR mode for a few seconds to cancel the Timer Recording.

(The "TIMER" Indicator goes out on Multi-Function Display.)

- Any future daily or weekly recording will be performed as programmed.



#### NOTES:

- If you are using a Cable Box, the VCR's channel for Timer Recording must be set to the Cable Box input channel and Cable Box must be manually set to the desired channel. Cable Box power must be left on.
- 2 minutes before Timer Recording is performed, "PLEASE -PREPARE FOR TIMER REC" appears and Timer Indicator flashes. Be sure a cassette with record tab is loaded and DECK is in Stop mode.
- If a power interruption occurs while programming the timer, the timer program(s) may be canceled. If "TIMER PROGRAMS WERE LOST DUE TO POWER INTERRUPTION" appears on-screen, please re-enter the timer programs.
- If the start time for Timer Recording comes up during recording and playing back, Timer Recording will not be performed.

#### Important Notes When Using DSS Receiver

- When recording programs via DSS Receiver, DSS Receiver must be left on.
- When recording programs via an antenna or cable, DSS Receiver must be turned off.

### 4-16.4.32 MTS Broadcast/VHS Hi-Fi Stereo System

#### Connection

Make the Audio/Video Connection as shown in Connection section found previously in this manual.

- You can use TV connected to a Stereo amplifier and speakers instead of Stereo TV.

### 4-16.4.33 Receivable Broadcast Types

The following are possible audio broadcast types and on-screen displays.

The signal being received is indicated with an “(( (“ mark while the selected audio mode is indicated with an arrow.

To display the broadcast signal being received,

→ press DISPLAY\*.

#### MTS Stereo and SAP Broadcast

Multi-channel Television Sound Stereo (main language) and Secondary Audio Program (sub language) broadcasts are being received simultaneously. Select STEREO or SAP audio mode.

#### MTS Stereo Broadcast

Multi-channel Television Sound Stereo broadcast. Select STEREO audio mode.

- If stereo broadcast is weak and display flickers, select MONO audio mode for possible better results.

#### SAP Broadcast

Secondary Audio Program (sub language) broadcast. Select SAP audio mode for the sub language.

#### MONO Broadcast

Normal monaural sound broadcast.

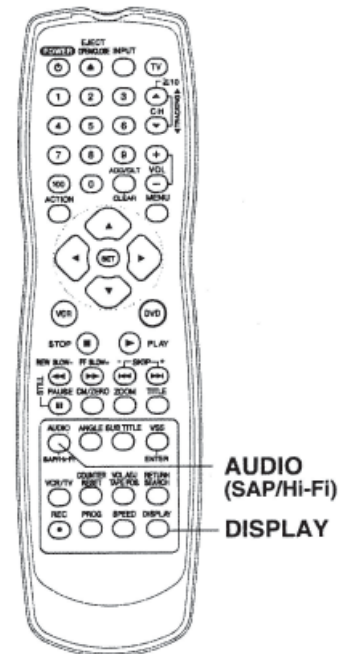
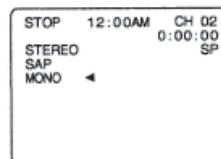
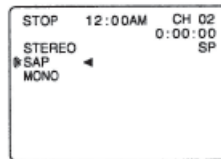
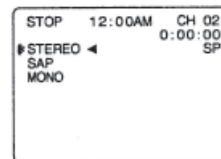
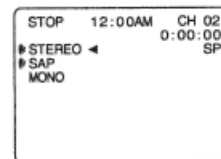

AUDIO (SAP/Hi-Fi)  
DISPLAY

Equipped with dbx®-TV Noise Reduction for true MTS reproduction. dbx®-TV Noise Reduction is required for good stereo separation and audio fidelity. dbx® is a registered trademark, and is licensed by dbx® Technology Licensing.

### 4-16.4.34 Audio Mode for Recording

- Press **AUDIO (SAP/Hi-Fi)** to display audio mode. (Display disappears after 5 seconds.)
- Press **AUDIO (SAP/Hi-Fi)** repeatedly to select desired mode.
  - Refer to “Receivable Broadcast Types” in previous section.
  - Arrow indicates selection.
- Make a recording.**  
See [Playback/Record on a Tape](#) Section found earlier in manual.

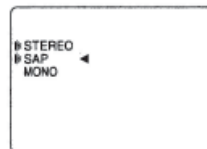

### 4-16.4.35 Audio Mode for Playback

1. Start playback.

See *Playback/Record on a Tape* section found earlier in manual.

2. Press AUDIO (SAP/Hi-Fi) to display audio mode.

3. Press AUDIO (SAP/Hi-Fi) repeatedly to select desired mode.

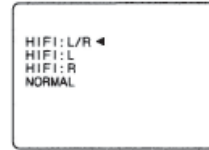

1. Select "HIFI (L/R)" or "HIFI (L)" or "HIFI (R)" to listen to stereo recordings in stereo sound. Select "NORMAL" for monaural sound.
2. Display disappears after 5 seconds.
3. Arrow indicates selection.



**NOTES:**

- Only tapes recorded in Hi-Fi stereo will playback with true stereo sound. Standard stereo tapes will playback in monaural sound.
- To listen to Hi-Fi stereo playback, the DECK AUDIO (L/R) jacks must be connected to a stereo TV or an external stereo amplifier and speakers.
- If tracking is adjusted during playback, Hi-Fi audio may revert to normal audio.
- Hi-Fi and normal audio playback volume level may differ.

### 4-16.4.36 Multi-Brand Control Feature

#### Multi-Brand Control Setup

The Remote Control can be set to control some TV functions.

1. Find your TV Brand Code Number on the chart found later in this section.
2. Set up for TV control,
  - hold down TV button,
  - enter code with NUMBER keys.
    - If code number is 100 or greater,
      - e.g., press 1 - 0 - 2 for 102.
3. Confirm code entry,
  - Press POWER to turn selected unit on or off.
    - See table on following page for controllable functions in each mode.

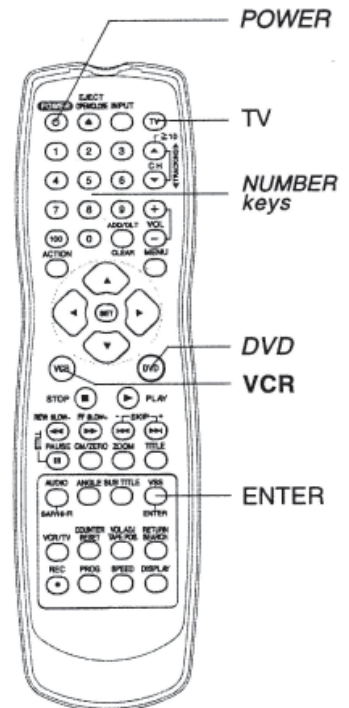

**NOTES:**

- Repeat setup after remote battery replacement.
- Remote will not control every TV made by the manufacturer listed. If you get no response, your particular unit cannot be controlled. There are NO additional codes for the products listed. If your product is not listed, then the remote is not compatible with that product.

### 4-16.4.37 Using Multi-Brand Control

After remote is set up, you can select VCR, DVD, or TV for the desired function.

Press **VCR**, **DVD**, or **TV** on the remote.

(Table below shows available remote buttons for each mode.)

Mode \ Input	DVD/VCR	TV
DVD/VCR	All	VOL +/-
TV	EJECT/OPEN/CLOSE*, DISPLAY, PLAY, STOP, FF/ SLOW+, REW/SLOW-VCR/TV, PAUSE/STILL, SKIP, AUDIO, CM/ZERO, TAPE POSITION, COUNTER RESET, SPEED REC	POWER, INPUT, NUMBER keys, ENTER, CH ▲ / ▼, VOL +/-

**Bold: VCR Function Italic: DVD Function**  
**Bold Italic: VCR and DVD Functions**

Normal: TV



#### NOTES:

- Not all functions listed may be controllable.
- In TV mode, it may be necessary to press ENTER after pressing NUMBER keys for channel selection.

#### TV Brand Code Numbers

Panasonic	01, 02	Sylvania	05	JVC	11
Quasar	01, 02	Sharp	06, 07	Hitachi	12
RCA	03	Sony	08	Mitsubishi	07, 13
GE	03	Toshiba	09	Samsung	14
Zenith	04	Sanyo	10	Gold Star	15, 16, 17
Magnavox	05	Fisher	10		

#### IMPORTANT NOTES:

- Some manufacturers use several codes for one brand. If the first code entered fails, try the next one listed.
- Some TV brands require you to turn on the power manually.

### 4-16.4.38 Tape Operation

#### Search System

For each recording, an invisible index mark is placed on the tape. A program index and information are also included for timer recordings. These marks are used to access or scan recordings.

#### INDEX SEARCH

```

INDEX SEARCH
ENTER INDEX NUMBER :1
USING 1-9 KEYS
FORWARD SEARCH :FF
REVERSE SEARCH :REW
NEXT :SEARCH
EXIT :STOP
  
```

1. Press **SEARCH\*** to display SEARCH in Stop or Play mode, and then **press NUMBER keys** to select recording number.

- To calculate number, see below.

Press FF/SLOW+ or REW/SLOW- on the remote to start search.

2. Play begins at search end.

To search forward or back 1 index, **press FF/SLOW+** or **REW/SLOW-** on the remote while screen left is displayed (10 sec.).

- To cancel, **press PLAY or STOP**.

```

INDEX SEARCH

FORWARD SEARCH : FF
REVERSE SEARCH : REW
  
```

■ To Calculate Index Number

**Example 1:**

To go to rec. 2 from rec. 4, enter 3 and press REW.

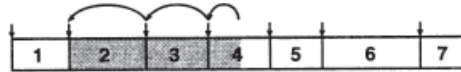

**Example 2:**

To go to rec. 6 from rec. 2, enter 4 and press FF.



**NOTES:**

↓ Indicates start points of each recording.

If Index Search is started very close to an index mark, that index mark may not be counted in the search.

**PROGRAM END SEARCH**

Locates end point of recording for continuity.

1. Press **SEARCH** twice to display SEARCH in Stop or Play mode.
2. Press **FF/SLOW+** on the remote to start PROGRAM END SEARCH.
  - To cancel, press **PLAY** or **STOP**.

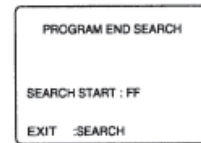

Examples of **Program End Search.**

Fig. 1

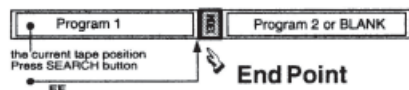

Fig. 2

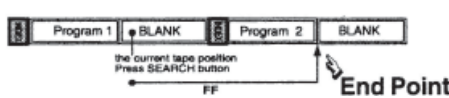
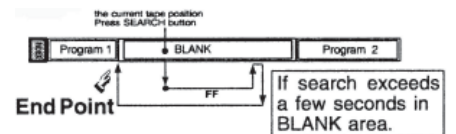

Fig. 3



Upon locating end point,

- Search continues 7 sec. past end point,
- Tape rewinds to 10 sec. before end point,
- Tape plays to end point and stops.



**NOTE:** If Program End Search is started very close to an index mark, that mark may be skipped over.

**AUTO OPERATION FUNCTIONS**

■ **Auto Play**

Insert a tape → Power comes on, → Play starts if there is no record tab

■ **Auto Rewind**

Play  
Fast Forward } → Tape end → Rewind

■ **Play Auto Eject**

(Repeat Play must be off)  
Play → Tape end → Rewind  
→ Tape ejects if set some programs.

**COMMERCIAL SKIP**

VCR fast forwards (skips) over 1-3 minutes of recorded tape.

■ **Press CM/ZERO** in Play mode.

- The skip time can be changed by pressing CM/ZERO repeatedly as shown by the figure below.
- No indication appears on-screen.

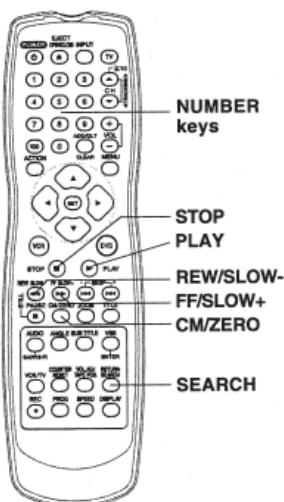
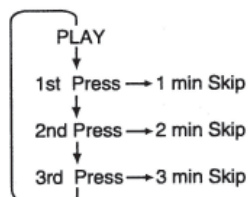



## REPEAT PLAY

Set to playback a recording over and over.

1. Press **ACTION**\* to display MENU.
2. Press **▲ ▼** to select "SET UP VCR," and press **SET**.

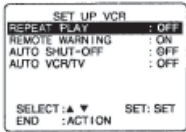
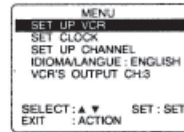

3. Press **▲, ▼** to select "REPEAT PLAY," and press **SET** to set "ON" or "OFF."
  - Play repeats at tape end or if unrecorded portion over 30 sec. is detected.
4. Press **ACTION** twice to return to normal screen.



**NOTE:** For repeat play in DVD mode, see "DVD Operation Using On-Screen Displays" section.

## ZERO SEARCH

To quickly return to a specified tape location.

1. Press **DISPLAY** during play to display Counter.
2. Press **COUNTER RESET** at desired position to reset to "0:00:00".

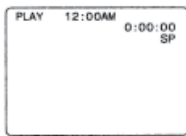

3. Continue to record, playback etc.
4. Press **STOP**.
5. Press **CM/ZERO** in Stop mode to start Zero Search.
  - DECK will go into FF or REW mode and stop at the last point the Counter was set to 0:00:00.

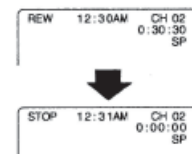

## VCR/TV Selector Feature

The VCR/TV selection can be set to auto or manual.

1. Press **ACTION** to display MENU.
2. Press **▲ ▼** to select "SET UP VCR," and press **SET**.

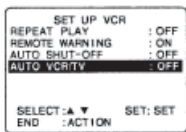
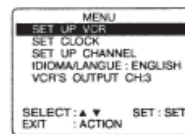

3. Press **▲ ▼** to select "AUTO VCR/TV," and press **SET** to set "ON" or "OFF."
  - Off (Manual): You select "VCR" or "TV" mode using the VCR/TV button on the remote.
  - ON (Auto): "VCR" mode is automatically set when VCR is turned on, or in Play mode.
4. Press **ACTION** to return to normal screen.



**NOTE:** For more on VCR/TV selection, see "Record One Station, Watch Another" and "Select Channels at DECK" sections found earlier in manual.

## 4-16.4.39 Special VCR Features

**IMPORTANT:** If a remote control button does not work when pressed, press the VCR button on the remote and try the button again.

### VCR Lock Feature

When set to ON, all operations except for timer record and tape eject are prohibited. Useful for households with small children.

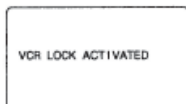

**To turn on, hold down REC** on DECK in Stop mode with no tape inserted for 7 seconds, (Please ignore "NO CASSETTE" warning.)

**To turn off,** repeat above.

- VCR Lock cancels in 24 hours if clock is set.

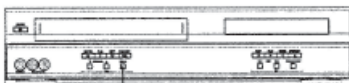
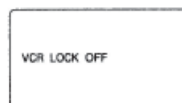

### Weak Signal Display Feature

When "ON," picture is displayed regardless of signal strength.

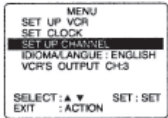

1. Press **ACTION** to display MENU.
2. Press **▲▼** to select "SET UP CHANNEL," and press **SET**.

3. Press **▲▼** to select "WEAK SIGNAL DISPLAY," and press **SET** to press "ON" or "OFF."
  - ON: Picture is displayed regardless of signal condition, and may not always be clearly visible.
  - OFF: Screen turns solid blue when signal is weak or non-existent.
  - Selecting ON has no effect on connected equipment with blue back feature.
4. Press **ACTION** twice to return to normal screen.

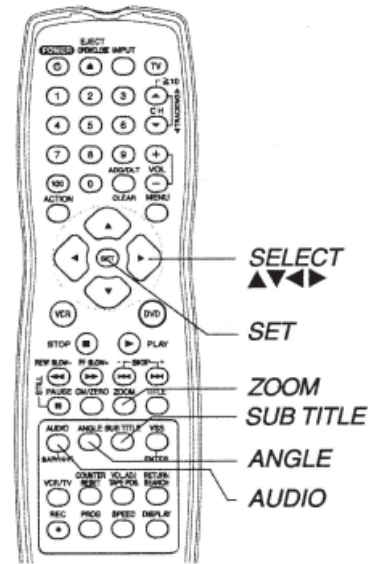
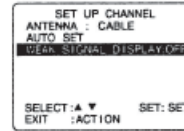

### Auto Shut-Off Feature

The power shuts off at a preset time.

1. Press **ACTION** to display MENU.
2. Press **▲▼** to select "SET UP VCR," and press **SET**.
3. Press **▲▼** to select "AUTO SHUT-OFF." Press **SET** repeatedly to change shutoff time as shown below.

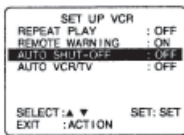

4. Press **ACTION** twice to return to normal screen.

**NOTE:** The shut-off countdown will not function during Play or Record.

### Remote Warning Feature

If Multi-brand feature is used, and this feature is set to on, a warning appears whenever an invalid key is pressed in TV mode.

1. Press **ACTION\*** to display MENU.
2. Press **▲▼** to select "SET UP VCR," and press **SET**.
3. Press **▲▼** to select "REMOTE WARNING," and press **SET** to set "ON" or "OFF."
  - If "OFF," remote warning will not appear when invalid key is pressed.
4. Press **ACTION** twice to return to normal screen

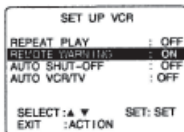
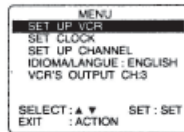

**IMPORTANT:** If a remote control button does not work when pressed, press the VCR button on the remote and try the button again.

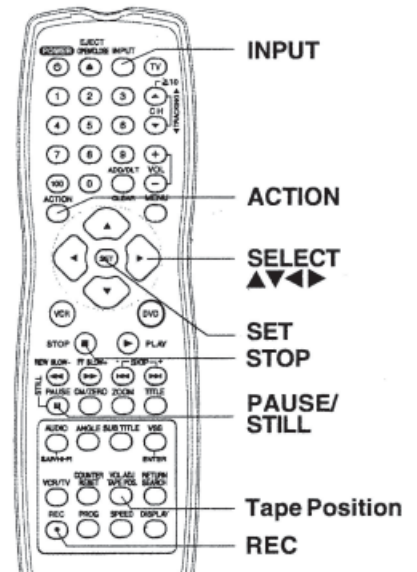

## Tape Position and Tape Status Feature

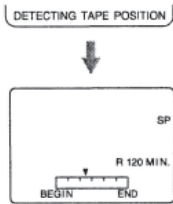

To find out the present tape position and amount of tape remaining. Tape position is displayed for VHS-C type Cassettes, tapes under 30 minutes long, and some other tapes, but the position is not correct.

- Press TAPE POS. to detect current tape position.
  - “DETECTING TAPE POSITION” is displayed only when a cassette is first inserted, and it takes several seconds for correct tape position to appear.
  - The present tape position indication and amount of tape remaining (according to tape speed) is displayed.
  - Tape remaining time display may not be precise.
- Press TAPE POS. to return to normal screen.

**NOTE:** This function cannot display exact amount of tape remaining for tapes 30 minutes or less, or for tapes over 120 minutes in length.

### 4-16.4.40 Copying Your Tapes (Dubbing)

#### Connection

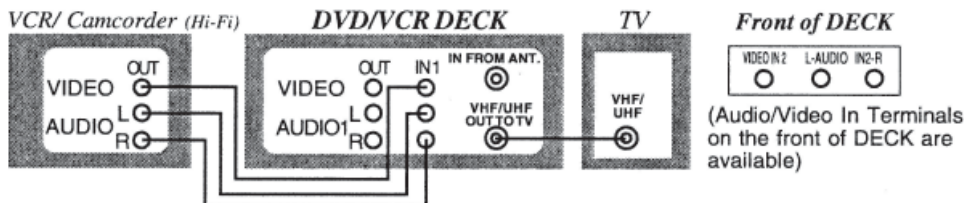

- Connect VIDEO OUT terminal on Playing VCR to VIDEO IN terminal on DECK. To monitor the dubbing, also connect TV as shown.
- Connect “L” and “R” AUDIO OUT terminals on Playing VCR to “L” and “R” AUDIO IN terminals on DECK. In place of Playing VCR, you can use other equipment such as a Camcorder. Simply connect the unit’s Audio/Video outputs to DECK.

#### Playing (Source) VCR

#### Recording (Editing) DECK

- |   |  |   |
|---|--|---|
| <b>1</b>  | Insert a pre-recorded tape.  | Insert a blank tape with record tab.  |
| <b>2</b>  | _____  | Press INPUT to set DECK Input mode to LINE for Video Input (See “ <a href="#">Selecting the Input Mode</a> ” below) |
| <b>3</b>  | Press PLAY, then PAUSE/STILL immediately to enter PLAY/PAUSE mode. | Press REC, then PAUSE/STILL immediately to enter REC/PAUSE mode.  |
| The operation of steps 4 and 5 must be done on the playing and recording VCRs at the same time. |  |   |
| <b>4</b>  | Press PLAY to start dubbing. Playing VCR starts playback.          | Press PAUSE/STILL to start dubbing. DECK starts recording.  |
| <b>5</b>  | Press STOP to stop dubbing.  | Press STOP to stop dubbing.   |

**■ To Monitor Dubbing on TV**

1. Turn TV on and tune to the Recording VCR channel (CH 3 or CH 4).
2. If Auto VCR/TV is set to “OFF”, press VCR/TV on the remote to be VCR mode.

**NOTE:** Dubbing tapes protected with Copy Guard will result in poor quality recordings.

**■ Selecting the Input Mode**

**Method 1:** Press INPUT repeatedly. Channel Number ↔ LINE1 ↔ LINE2

**Method 2:** Press CH ▲/▼. Display will change as below.

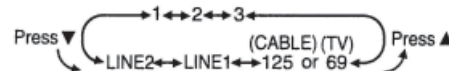

- “L1” or L2” lights up on Multi-Function Display (about 4 seconds) when LINE1 or LINE2 is selected.
- LINE1: For rear audio/video connection.
- LINE2: For front audio/video connection.

**CAUTION!!**

- Unauthorized exchanging and/or copying of copyrighted recordings may be copyright infringement
- Please note that some tapes cannot be dubbed on DECK. Also, it is not possible to dub DVD/Video CD/CD to VHS tapes using DECK.

**4-16.4.41 Disc Operation**

**Subtitle Language (DVD Only)**

You can select a different subtitle language (if offered) than the one set at the Settings for DVD Operation. See “[Settings for DVD Operation](#)” found later in manual.



**1. Press SUB TITLE\*** in Play mode to display the subtitle selection on-screen.

- Display disappears after 5 seconds.
- When no subtitles are offered, “-” will be displayed instead of the language number.

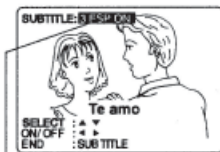

**2. Press ▲ ▼** to select a language.  
**3. Press ▲ ▼** to select “ON” or “OFF.”

Subtitle language being played back (see Subtitle Language chart on right)

**[Subtitle Language]  
[Audio sound track language]**

<b>ENG</b>	English
<b>FRA</b>	French
<b>DEU</b>	German
<b>ITA</b>	Italian
<b>ESP</b>	Spanish
<b>NLD</b>	Dutch
<b>SVE</b>	Swedish
<b>NOR</b>	Norwegian
<b>DAN</b>	Danish
<b>POR</b>	Portuguese
<b>RUS</b>	Russian
<b>JPN</b>	Japanese
<b>CHI</b>	Chinese
<b>KOR</b>	Korean
<b>MAL</b>	Malay
<b>VIE</b>	Vietnamese
<b>THA</b>	Thai
<b>*</b>	Other

**NOTES:**

- If after several presses of the button the language does not change, language selection is not offered on the disc.
- When disc is removed, subtitles revert to initial setting language. If the initial language is not recorded on the disc, the disc’s priority language will appear.

Change the No. by **pressing ▲ ▼**, and **press SET**.

### Audio Soundtrack Language (DVD only)

You can change the audio soundtrack language, selected at the Settings for DVD Operation, to a different language if available. See **“Settings for DVD Operation”** later in manual.

(This operation works only with discs on which multiple audio soundtrack languages are recorded.)

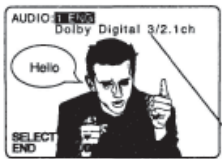

1. Press **AUDIO** in Play mode to display the audio selection on-screen.

- Display disappears after 5 seconds.

Audio attribute 1 type, sampling frequency, bit No. of the disc or number of speaker channel.



2. Press **▲ ▼** to select desired language.

Audio soundtrack language being played back (see chart, at right).

**[Audio attribute 1 type, sampling frequency, bit No. of the disc (see “Settings for DVD Operation” section, later in manual.)]**

LCPM	96 kHz or 48 kHz	16bit	Linear PCM disc
		20 bit	
		24 bit	
Dolby Digital	1 ch - 5.1 ch	Dolby Digital Disc	
DTS	1 ch - 5.1 ch	DTS disc	



#### NOTES:

- If, after several presses of the AUDIO button the language does not change, language selection is not offered on the disc.
- When disc is removed, language reverts to initial setting. If this language is not recorded on the disc, the language recorded will be heard.

**IMPORTANT: If a remote control button does not work when pressed, press the DVD button on the remote and try the button again.**

When  appears on the screen while a button is being operated, it means that the corresponding operation is prohibited by DECK or the disc.

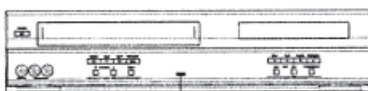

ANGLE Indicator



#### NOTES:

- The ANGLE indicator lights up on DECK when a scene recorded at different angles is detected.
- The angle number can be set beforehand so that the angle is switched whenever the ANGLE indicator lights up.

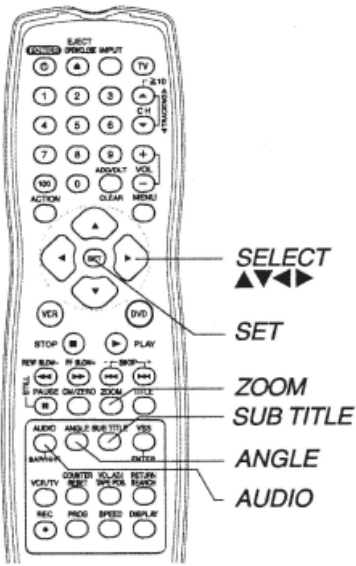

- NOTES:**
- The subtitle cannot be enlarged nor can its position be changed.
  - The picture zoom feature does not work with a Video CD.
  - During picture zoom, “ZOOM1” or “ZOOM2” appears on-screen for 5 seconds.
  - Zooming, on some discs, may result in poor picture quality, or may not operate at all.

**Multiple Angle Viewing (DVD Only)**

DVDs may contain scenes shot from multiple camera angles allowing the same scene to be viewed at different angles. You can view these angles, if available, using the ANGLE button.

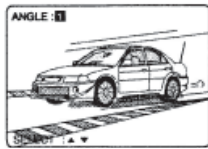

1. Press ANGLE in Play mode to display the angle selection on-screen.
  - Display disappears after 5 seconds.

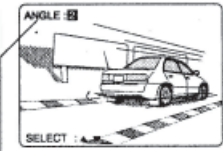

2. Press ▲ ▼ to select the desired angle.  
Number of angle being played back.

**Vocal Selection for Karaoke Discs (DVD/ Video CD)**

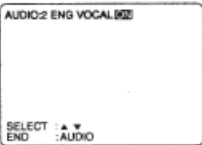

1. Press AUDIO in Play mode to display the audio screen.
2. Press ▲ ▼ (or ◀ ▶) to select as shown below, and press ▲ (or ▼) to set. (DVD only).

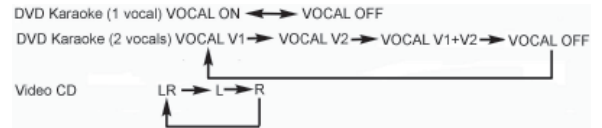

**Picture Zoom (DVD Only)**

You can enlarge specific portions of a picture and select the zoom ratio using the ZOOM button during DVD playback.

Press **ZOOM** repeatedly to change display as follows.

- You can enlarge the center portion of the image to one of 2 magnifications.

Use the ▲, ▼, ◀ and ▶ buttons to move the position up, down, left and right.

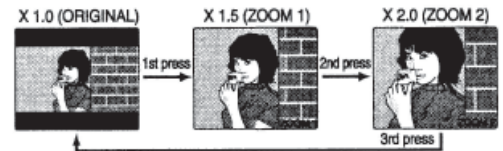

### Title Menu (DVD Only)

Some DVDs have more than one title, e.g. movies. If the disc offers a title menu, you can select the desired title number. (Operation may vary according to the disc.)

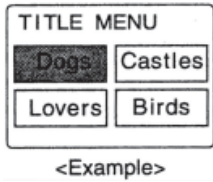

1. Press **TITLE\*** in Play mode to display the title screen.



2. Press **▲▼◀▶** or **NUMBER keys** to select a title, and press **SET** or **PLAY** to start playing.
- “Pressing SET or PLAY” is not necessary when using NUMBER keys.

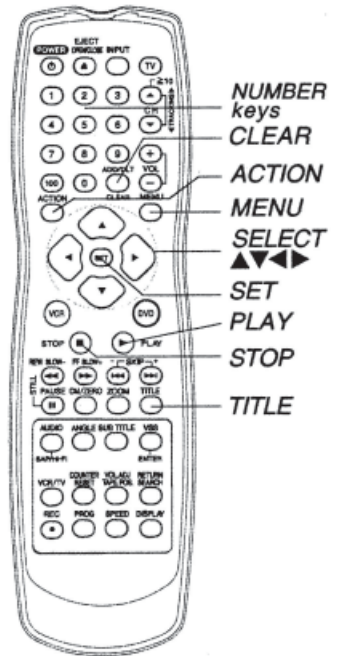

### DVD Menu (DVD Only)

DVDs may offer a special menu. This menu may include guides to unique contents, audio/subtitle languages, etc. Although contents and operation may vary, the following steps show basic steps for using the menu.

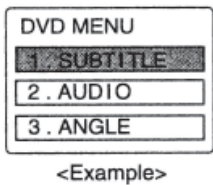

1. Press **MENU** in Play mode to display DVD MENU.

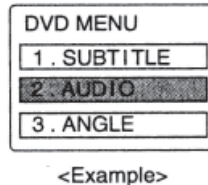

2. Press **▲▼◀▶** or **NUMBER keys** to select an item, and press **SET** or **PLAY** to perform.
- “Pressing SET or PLAY” is not necessary when using NUMBER keys.

**Repeat step 2 if there is more than one menu.**

### Program Play (Video CD/CD only)

You can program specific tracks and order of play.

1. Press **ACTION** to display DVD MAIN MENU.

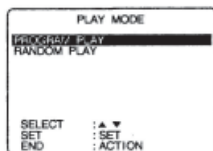

2. Press **▲▼** to select “PLAY MODE,” and press **SET** to display.

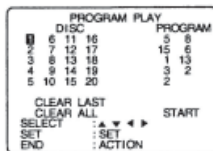

3. Press **▲▼** to select “PROGRAM PLAY,” and press **SET** to display.

4. Press **▲▼◀▶** to select a track number (Track numbers on disc are displayed.), and press SET.

- Repeat step 4 to select another track.
- The selected track is added on the right side.

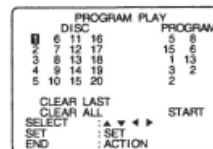



5. Press ▲▼◀▶ to select "START," and press SET to start play of programs in the sequence selected.
  - To cancel, press STOP during play, then press CLEAR.



**NOTES:**

- Up to 15 tracks can be programmed.
- "◀" or "▶" (depending on disc) indicates additional PROGRAM PLAY screen. Press ▲▼◀▶ for next or previous screen.
- To clear the last program one by one Press ▲▼◀▶ move to "CLEAR LAST" and press SET. (Pressing CLEAR on remote control also clears last program.)
- To clear all programs press ▲▼◀▶ move to "CLEAR ALL" and press SET. (Programs are also cleared when the power is turned off or the disc is removed.)

**Ready Checklist**

- DECK is in DVD mode, press DVD.
- Video CD or CD is inserted.

**Program Repeat Play (Video CD/CD only)**

1. Follow steps 1 through 5 on this page.

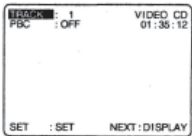

2. Press DISPLAY to display Disc Information screen. (Disc Information Screen)
3. Press DISPLAY to display DECK Information screen.



4. Press SET to enter Select mode. Cursor move to "OFF."  
(DECK Information Screen)

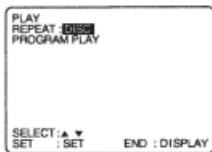

5. Press ▲▼ to select "DISC." (DECK Information Screen)
6. Press SET to set mode. Cursor move to "REPEAT." To cancel, select "REPEAT : OFF" in step 5, then press SET.

**Random Play (Video CD/CD Only)**

**Ready Checklist**

- DECK is in DVD mode, press DVD.
- Tracks are played in a random order.



1. Press ACTION\* to display DVD MAIN MENU.
2. Press ▲▼ to select "PLAY MODE," and press SET to display.
3. Press ▲▼ to select "RANDOM PLAY," and press SET to begin random play.

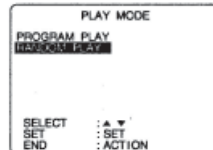

- To cancel, press STOP during play, then press CLEAR.

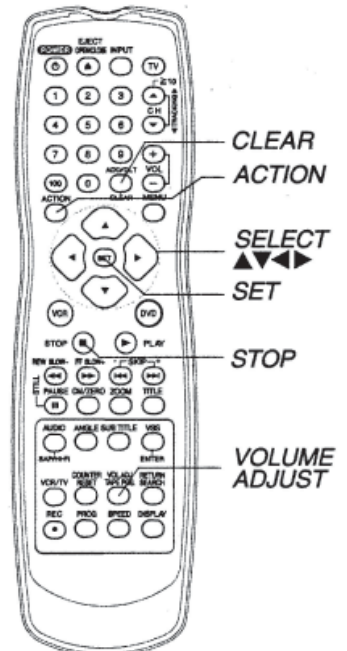

**IMPORTANT: If a remote control button does not work when pressed, press the DVD button on the remote and try the button again.**



### Setting the VOLUME ADJUST

Some DVDs are recorded in lower average volume level. For these DVD, this DECK can be set so that the average volume is increased.

Press **VOL.ADJ** repeatedly to change “ON” ↔ “OFF.”

“ON” or “OFF” lights up on Multi Function Display (for about 3 seconds) when press VOL.ADJ.

	VOLUME ADJUST “OFF”	VOLUME ADJUST “ON”
Some DVD [Volume level is low]	Volume is the original level.	Volume level is increased when played back.

- “ON” is set. . .When a DVD is played back, the average volume is increased.
- “OFF” is set. . .The volume level recorded on the disc is played back just as it is.

**NOTES:**

- When audio equipment is connected, setting the Sound Output level to “OFF” is recommended.
- If the sound becomes abnormal while playing a disc, set the Sound Output level to “OFF.”

### 4-16.4.42 DVD Operation Using On-Screen Displays

When DISPLAY is pressed, On-Screen Displays show disc information (title/chapter/track number, elapsed playing time) and DECK information (repeat play, play mode).

1. Press **DISPLAY** in Play or Stop mode to display “On-Screen Displays.”

- Each **press** of **DISPLAY** changes the on-screen display as follows. (See “Detailed Descriptions of Each On-Screen Display” found later in manual.)

**NOTE:** DISPLAY button does not function while DVD TITLE MENU is displayed.

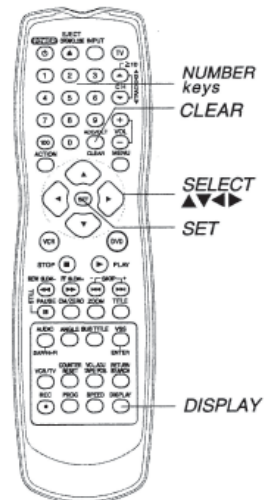
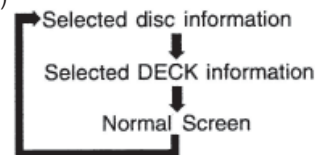

#### Ready Checklist

- DECK is in DVD mode, press DVD.
- 2. Press **▲▼** (or **◀▶**) to select an item, and **press SET**.
- 3. Press **▲▼** or **NUMBER keys** to select the setting, and **press SET**.

#### <Example of DVD>

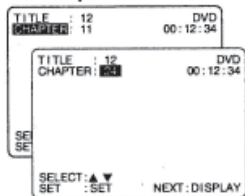

- When numbers are displayed (e.g. title number), NUMBER keys are also available.
- If the number entered is not on the disc, the entry will have no effect. Re-enter the correct number.
- For more details, refer to the disc operation information.

**To return to normal screen, press CLEAR or DISPLAY repeatedly.**

#### <Example of Video CD>

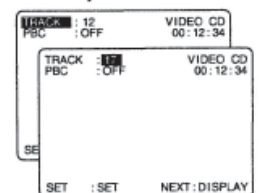

**NOTES:**

- When DISPLAY button is pressed during playback of a Video CD with Playback control NUMBER keys are not available on the displayed screen. In this case, press DISPLAY again to remove the displayed screen.
- When  appears on the screen while a button is being operated, it means that the corresponding operation is prohibited by DECK or the disc.

**Detailed Descriptions of Each On-Screen Display**

■ Disc Information Screen (for DVD)

**1. TITLE No.**

- Select “TITLE”, and press SET\*.
- Change the No. by pressing ▲▼ or NUMBER keys, and press SET.

**2. CHAPTER No.**

- Select “CHAPTER”, and press SET.
- Change the No. by pressing ▲▼ or NUMBER keys, and press SET.

**3. Disc Currently being played**

**4. Elapsed playing time**

The screen may be changed by selecting the elapsed time.

- Select the elapsed playing time (“xx:xx:xx”), and press SET.
- Change the elapsed time by pressing NUMBER keys. Hours → Minutes → Seconds are entered in order. If the time entered is not on the disc, the entry will have no effect. Re-enter the correct time. e.g., press  $\underline{0} - \underline{1} - \underline{2} - \underline{3} - \underline{4} - \underline{5}$  for 01 : 23 : 45.
- This function does not work with some discs.  $\underline{0}$  Hour  $\underline{1}$  Minutes  $\underline{2}$  Seconds

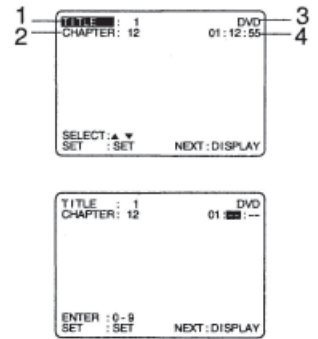

If SET is pressed while making entries, unit returns to the condition before entries were made.

■ Disc Information Screen (for Video CD/CD)

**A. TRACK No.**

- Select “TRACK”, and **press SET**.
- Change the No. by **pressing ▲▼ or NUMBER keys**, and **press SET**.

**B. Playback control ON/OFF**

[Video CD with playback control only]

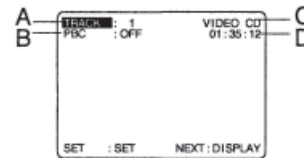

ON	Video CD menu play is displayed.
OFF	Video CD menu play is not displayed.

**C. Disc currently being played**

Video CD	CD
----------	----

**D. Elapsed playing time**



**NOTES:**

- Track No. and the elapsed playing time are not displayed during play started from menu of Video CDs with playback control.
- When appears on the screen while a button is being operated, it means that the corresponding operation is prohibited by DECK or the disc.

**DECK Information Screen (for DECK)**

**a. Repeat Play**

- Select "REPEAT", and **press SET**.
- Change the desired mode during play by **pressing ▲▼**; and **press SET**

DVD	REPEAT CHAPTER	REPEAT TITLE	REPEAT OFF
Video CD/CD	REPEAT TRACK	REPEAT DISC	REPEAT OFF

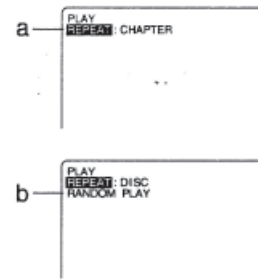

**b. Play mode** [Video CD/CD only] see "Program Play (Video CD/CD Only)" section found earlier in manual.

PROGRAM PLAY	program play
RANDOM PLAY	random play
----	normal play

For your reference

CHAPTER/TITLE REPEAT PLAY (DVD)

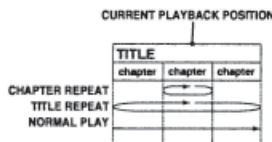

TRACK/DISC REPEAT PLAY (Video CD/CD)

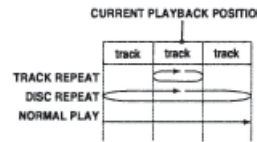

**NOTE:** For repeat play in VCR mode, see "Repeat Play" section found earlier in manual.

**4-16.4.43 MP3/WMA/JPEG Playback Operation**

This unit can play MP3/WMA/JPEG format CD-R or CD-RW recorded for personal use on a PC, etc. Some discs may not play due to the condition of the recording.

1. Press POWER on the remote or DECK.
2. Press OPEN/CLOSE, then place an MP3/WMA/JPEG disc into the disc tray. Press OPEN/CLOSE to close.
3.
  - MP3/WMA/JPEG menu is displayed.
  - Playback starts automatically (except JPEG files).
  - CD directory is displayed.
4.
  - **Select file** (During STOP mode)
    - 1) Press ▲▼ to select an MP3/WMA file (▲/▼). → MP3/WMA Playback
    - 2) Press ▲▼ to select a JPEG file (📷). → JPEG Playback
    - 3) Press SKIP ►► | (next) or | ◀◀ SKIP (previous) to skip a file/folder page (7 files) in the File area.
  - **Select folder** (During STOP mode)
    - 1) Press ▲▼ to select a folder (📁).
    - 2) Press SET to display files/folders contained in the folder.
  - **Select Parent Folder** (During STOP mode)
    - 1) Press ▲▼ to select a folder (📁).
    - 2) Press SET to make changes to the previous directory display.

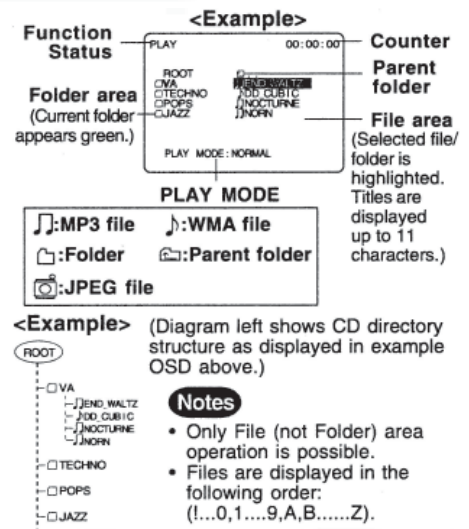

**5. Press ACTION** to return the DVD MAIN MENU. (→ **Press ACTION** again to return the MP3/WMA/JPEG MENU.)

## MP3/WMA Playback

Follow steps 1-3 found previously.

- Press **▲▼** to select an MP3/WMA file (🎵). (During STOP mode)
- Press **SET** or **PLAY** to start playback

### ■ Forward/Reverse Search

Press **FF/SLOW+** or **REW/SLOW-** during play.

Press **PLAY** to release.

- Search speed, slow at first, increases with each additional press of the button up to 5 levels.

### ■ Forward/Reverse Track Skip

Press **SKIP ►►** | or | **◄◄ SKIP** during play.

Each press skips a track.

- If pressed within first 3 seconds of playback, skips to the previous track. If over 3 seconds, returns to top of track. (| **◄◄ SKIP** only.)
- Put DECK in Stop mode before performing folder/file selection. (see step 4)

### ■ Pause

Press **PAUSE** during play. Press **PLAY** to release.

- Press **STOP** to stop play.
- Press **OPEN/CLOSE** to eject the disc. The MP3/WMA/JPEG MENU is closed automatically.



**NOTE:** Copyright protected files and files containing errors cannot be played back. The DECK skips to the next file.

### ■ Select PLAY MODE [MP3/WMA Playback] (During STOP mode)

- Press **◄►** to move cursor to PLAY MODE.
- Press **▲▼** to select the desired PLAY MODE (see chart at right).

### [PLAY MODE]

#### NORMAL:

All MP3/WMA files are selected and played back one time only.

#### SINGLE REPEAT:

The selected MP3/WMA file is played back repeatedly.

#### FOLDER REPEAT:

The MP3/WMA files contained in the selected folder are played back repeatedly. However, folders below the selected folder are not played back.

#### DISC REPEAT:

All MP3/WMA files are played back repeatedly.

**IMPORTANT HINT:** If a remote control button does not work when pressed, press the DVD button on the remote and try the button again.

## JPEG Playback

You can play back JPEG images.

**Displayable Image Size:** 32x32~7680x7680 pixels



**NOTE:** Some JPEG formats may not be played back.

Follow steps 1-3 on previous page.

- Press **▲▼** to select a JPEG file (📷).
- Press **SET** or **PLAY**. Selected JPEG file is displayed.

### [JPEG Playback Screen]

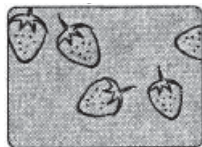

<Example>

#### ■ Returned on the MP3/MWA/JPEG MENU

→ Press **STOP**.

#### ■ Next/Previous Search

→ Press **SKIP ►►** | or | **◄◄ SKIP**.

■ **Start Slide-show** → Press **FF/SLOW+** or **REW/SLOW-**

■ **Enlarging an image** → Press **ZOOM**.

■ **Rotating an image** → Press **ANGLE**.

- Press **STOP** to return the MP3/WMA/JPEG MENU.

**JPEG Slide-Show**

(During JPEG Playback.)

JPEG files are displayed automatically (about every 3 seconds) as a slide-show.

**1. Press FF/SLOW+ or REW/SLOW-**

<Example>

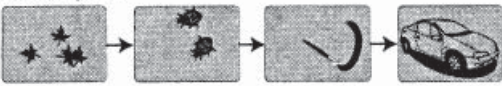

Image changes every 3 seconds.

■ **Cancel slide show**

→ Press **STOP** to return the MP3/WMA/JPEG MENU.

■ **Still picture**

→ Press **STILL** (only SLIDE).

→ Press **PLAY** to release.

■ **Forward/Reverse File Skip**

→ Press **SKIP** ►►► or ◀◀◀ **SKIP**.

Each press skips a file.

**2. Press ACTION** to return the DVD MAIN MENU.

■ **Select PLAY MODE [JPEG Slide-show]**

(During STOP mode)

- 1) Press ◀► to move cursor to PLAY MODE.
- 2) Press ▲▼ to select the desired PLAY MODE

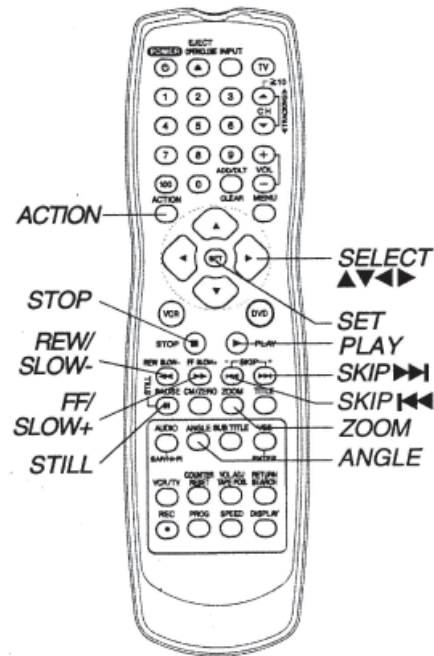

**JPEG Zoom**

(During JPEG Playback)

You can enlarge specific portions of a JPEG picture and select the zoom ratio using the ZOOM button on the remote during JPEG Playback screen.

**Set Zoom size**

Press **ZOOM** repeatedly to change display as follows.

→ Press **STOP** to return the MP3/WMA/JPEG MENU.

- You can enlarge the center portion of the image to one of 2 magnifications.
- Operation can be done during Rotation (see [Rotation](#) next page).

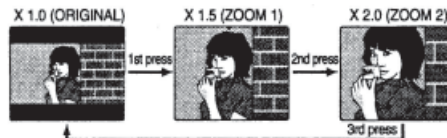

<Example>  
Operation can be done when files are in order, such as in the diagram below.

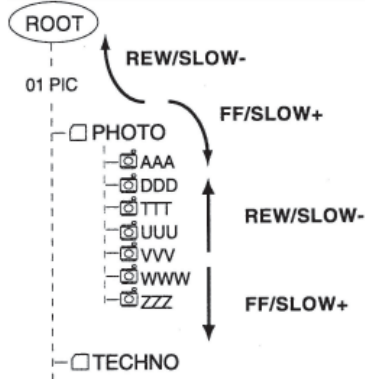

**[PLAY MODE]**

<b>NORMAL:</b>
All JPEG files are selected and played back one time only.
<b>SINGLE REPEAT:</b>
The selected JPEG file is played back repeatedly.
<b>FOLDER REPEAT:</b>
The JPEG files contained in the selected folder are played back repeatedly. However, folders below the selected folder are not played back
<b>DISC REPEAT:</b>
All JPEG files are played back repeatedly.

## JPEG Rotation

(During JPEG Playback)

You can rotate a JPEG picture using the ANGLE button on the remote during JPEG Playback screen. (The JPEG picture will be rotated 90° clockwise.)

### Set rotation

Press **ANGLE** repeatedly to change display as below.

→ Press **STOP** to return the MP3/WMA/JPEG MENU

- Operation can be done during Zoom (above).
- The vertical/horizontal ratio of rotated JPEG images may vary when they are displayed.

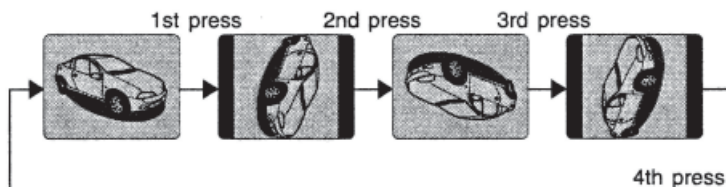

MPEG Layer-3 audio decoding technology licensed from Fraunhofer IIS and Thomson multimedia. **MP3** PLAYER

Windows Media, and the Windows logo are trademarks, or registered trademarks of Microsoft Corporation in the United States and/or other countries. WMA is a compression format developed by Microsoft Corporation. It achieves the same sound quality as MP3 with a file size that is smaller than that of MP3.



## 4-16.4.44 DVD Lock Feature

**IMPORTANT:** If a remote control button does not work when pressed, press the DVD button on the remote and try the button again.

You can prevent playback of DVDs of a specific rating level which may be unsuitable for children. Some DVDs are encoded with a rating level. If the disc rating is higher (stricter) than the one you preset, playback will be prohibited.

### 4-16.4.44.1 DVD Lock (DVD Only)

A 4-digit code must be entered to view a blocked program or change rating settings.

1. Press **ACTION**\* to display DVD MAIN MENU.
2. Press **▲▼** to select "PARENTAL LOCK," and press **SET** to display.
  3. 1) Press **NUMBER** keys to enter your secret code.
  - 2) Enter same secret code again for confirmation.
  - 3) Press **SET** to display.
    - Step 2) not necessary when changing rating or secret code.
    - Take care that you are not observed entering the secret code.

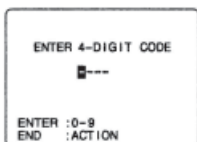
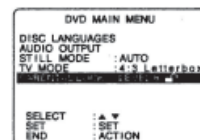

To Make Corrections Press **◀** repeatedly to move the cursor. Press **NUMBER** keys to make the correction.

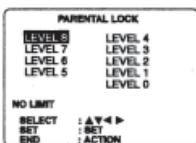

4. Press **▲▼◀▶** to select rating level, and press **SET** to select "LOCKED" OR "UNLOCKED."
  - LEVEL 0** : LOCK ALL, Playback of all DVDs, CDs, Video CDs, MP3, WMA and JPEG is prohibited.
  - LEVEL 1** : mature theme DVDs
  - LEVEL 2** : DVDs expressly for children can be played back.
  - LEVEL 3 to 7** : DVDs for general audiences/children can be played back. (DVDs with mature content are prohibited.)
  - LEVEL 8** : NO LIMIT: (Factory preset) All DVDs can be played back.

## ✓ Ready Checklist

- DECK is in DVD mode, press DVD.

### CAUTION!!

Discs not encoded with rating level will play even if the jacket states it is for mature audiences. For these discs, the DVD Lock Ratings will not work.

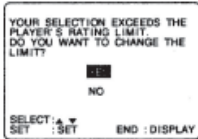

#### <When DVD Lock is activated>

After DVD Lock is set and a blocked DVD is played, the above message will appear. The message may differ depending on the disc.

To continue viewing a blocked program for now, Press **▲▼** to select "YES" and SET. Then, enter your 4 digit secret code (see step 3 found previously). When "NO" is selected, blocked programs cannot be viewed.

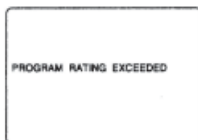

#### <When blocked programs>

##### Change your secret code

- You will need your current code. Do step 1-2 above. Enter current secret code. Press CLEAR to clear the code. Do step 4 to enter new code



**NOTE:** DO NOT forget your secret code.

## 4-16.4.45 Settings for DVD Operation

1. Press ACTION to display DVD MAIN MENU.
2. Press **▲▼** to select an item, and press SET.

**DISC LANGUAGES** (See [Disc Languages](#) section to follow). All languages offered on the disc can be set. If the language not offered is set, the original disc language will be selected.

**AUDIO OUTPUT** (See [Audio Output](#) section to follow). You can set the audio output that comes from the digital audio output terminal.

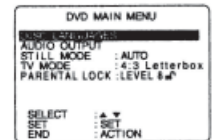

**STILL MODE** (See [Still Mode](#) section to follow). To select "FIELD" (Field still) or "FRAME" (Frame still) to prevent jitter or make small text or fine patterns clearly visible in a still picture. When "AUTO" is set "FIELD" or "FRAME" is selected automatically.

**TV MODE** (See [TV Mode](#) section to follow). To select whether the video material for a wide-screen will be played back in the Pan & Scan style, Letterbox style, or 16 : 9 style.

### 4-16.4.45.1 Disc Languages (DVD Only)

To select and set the language of the audio soundtrack, subtitles, or title/DVD menus for all discs to be played.

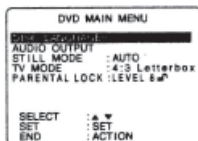

3. Press **▲▼** to select "DISC LANGUAGES," and press SET to display screen.
4. Press **▲▼** to select an item, and **press SET** repeatedly for desired language. See "AUDIO" selections following.
5. Press **ACTION** to re-display DVD MAIN MENU and go to step 2 to setup another item. Or, **press ACTION** twice to exit.



Once initial settings are done, they remain in memory (even after power off) until changed. This means DECK will operate under the same conditions (especially DVDs) each time.

**Ready Checklist**

- DECK is in DVD mode, press DVD.

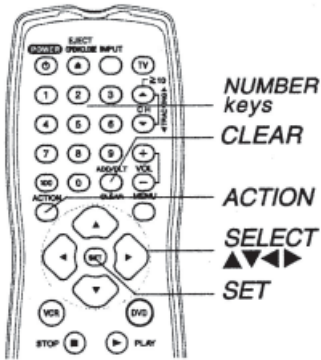

**“AUDIO” selections** (Factory preset: English) To select the audio soundtrack language, **English/Spanish/French/Japanese Original:** Original disc language **OTHER \*\*\*\*:** Other language selection\*1

**“SUBTITLE” selections** (Factory preset: AUTO) To select the subtitle language.

**AUTO:** Same language selected for “AUDIO”

- If language set for “AUDIO” is used in playback, subtitles will not appear.
- If another language is used during playback, the subtitles will appear in the language selected at “AUDIO” setup.

**English/Spanish/French/Japanese OTHER \*\*\*\*:** Other language selection\*1

**“MENUS” selections** (factory preset: English) To select the language used in title menus or DVD menus. **English/Spanish/French/Japanese OTHER \*\*\*\*:** Other language selection\*1

To enter **OTHER \*\*\*\* code number**, Press **NUMBER keys** (Please refer to [language codes](#) found later in manual). To make corrections, press **◀** repeatedly to delete language code number, and correct.

\*1If the selected language is not offered, the original disc language is selected.

**4-16.4.45.2 Audio Output**

Select the digital output to be output from the optical digital audio output connector of DECK.

1. Press **ACTION**\* to display DVD MAIN MENU.

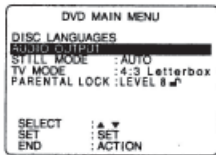

2. Press **▲▼** to select “AUDIO OUTPUT,” and press SET to display screen.
3. Press **▲▼** to select an item, and press SET repeatedly for output. (See below).

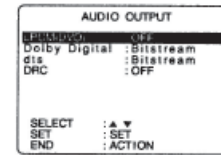

■ **“LPCM (DVD)” selections**

**OFF:** Linear PCM of less than 48 kHz/16 bit is output. When playing DVDs recorded in linear PCM of over 48 kHz/20 bit, no digital audio is output. (Factory preset).

**PCM:** When playing DVDs recorded in linear PCM of 48 kHz/20 bit/24 bit or more, digital audio converted to 44.1 kHz/16 bit or 48 kHz/16 bit is output. (Digital output of PCM audio is restricted to 48 kHz/16 bit or below for copyright protection.)

■ **“Dolby Digital” selections**

**Bitstream:** Dolby Digital bitstream (1 ch-5.1ch) is output (Factory preset)

**PCM:** When you have connected a amplifier that doesn’t have a built-in Dolby Digital decoder.

■ **“DTS” selections**

**Bitstream:** DTS bitstream is output. (Factory preset)

**PCM:** When you have connected a amplifier that doesn’t have a built-in DTS decoder.

■ **“DRC (Dynamic Range Compression)” selections**

**OFF:** Normal audio range is selected (Factory preset)

**ON:** For dynamic sound even at low volume, this is useful for late-night listening. [Dolby Digital DVDs only].

4. Press **ACTION** to redisplay DVD MAIN MENU and go to step 2 to setup another item. Or, press **ACTION** twice to exit.



**Ready Checklist**

- DECK is in DVD mode, press DVD.

Type of amplifier to be connected	Recommended Setting		
	LPCM (DVD)	Dolby Digital	DTS
No amplifier is connected	-----	-----	-----
AV amplifier (with digital audio input connector) without Dolby Digital/DTS decoder	PCM	PCM*1	PCM*1
AV amplifier including Dolby Digital decoder	PCM	Bitstream	PCM
AV amplifier including Dolby Digital/DTS decoder	PCM	Bitstream	Bitstream*2

- Make settings according to amplifier connected to optical audio output as shown in above table.
- \*1 When connecting an amplifier (with an optical digital input connector) which does not contain the Dolby Digital or DTS decoder, be sure to select "PCM". If "Bitstream" is selected, starting DVD play may cause such a high level of noise as to be harmful to your ears and damage the speakers.
- \*2 When a DTS decoder is connected, please select "Bitstream" in "dts".

**4-16.4.45.3 Still Mode**

Set to reduce jitter in a displayed still picture or a motion picture.

1. Press **ACTION** to display DVD MAIN MENU.



2. Press **▲▼** to select "STILL MODE," and press **SET** repeatedly for mode. (See below.)  
**AUTO:** "FIELD" (Field still) or "FRAME" (Frame still) is automatically selected during the still mode. (Factory preset)

**FIELD:** "FIELD" (Field still) is always selected. This setting will reduce jitter when compared with "AUTO" on some discs.  
**FRAME:** "FRAME" (Frame still) is always selected. Some texts and fine patterns will be seen clearly when compared with "AUTO" on some discs.

3. Press **ACTION** to exit this mode.

**4-16.4.45.4 TV Mode**

Set the screen display style for wide-screen video material playback.

1. Press **ACTION** to display DVD MAIN MENU.

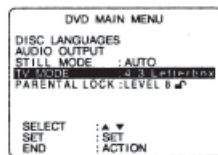

2. Press **▲▼** to select "TV MODE," and press **SET** repeatedly for mode. (See below.)  
**4:3 Pan & Scan (Factory preset):** Wide-screen video data is played in Pan & Scan style (left and right of screen is trimmed).  
  - Video data not formatted in Pan & Scan will play in letterbox style.

**4:3 Letterbox:** Wide-screen video data is played in Letterbox style (top and bottom of screen has black margin).

**16:9:** Set "16:9" when using Wide-screen TV.

3. Press **ACTION** to exit this mode.

**Example:**

**Pan & Scan** (Factory Preset)

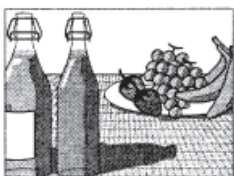

**Letterbox**

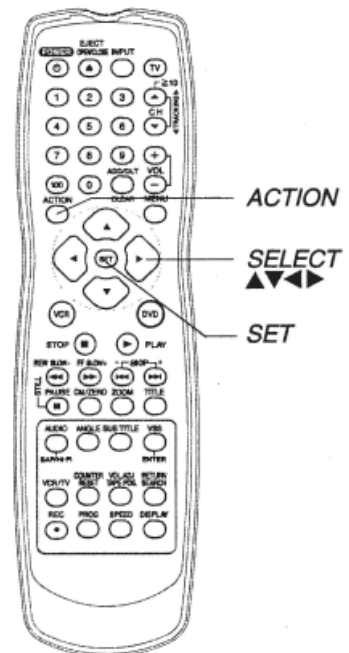

### 4-16.4.46 Language Code List

Enter the appropriate code number for the initial settings "AUDIO", "SUBTITLE" and/or "MENUS"

Code	Language	Code	Language	Code	Language	Code	Language
6565	Afar	7079	Faroese	7678	Lingala	8375	Slovak
6566	Abkhazian	7082	French	7679	Laothian	8376	Slovenian
6570	Afrikaans	7089	Frisian	7684	Lithuanian	8377	Samoan
6577	Ameharic	7165	Irish	7686	Latvian, Lettish	8378	Shona
6582	Arabic	7168	Scots Gaelic	7771	Malagasy	8379	Somali
6583	Assamese	7176	Galician	7773	Maori	8381	Albanian
6588	Aymara	7178	Guarani	7775	Macedonian	8382	Serbian
6590	Azerbaijani	7185	Gujarati	7776	Malayalam	8385	Sundanese
6665	Bashkir	7265	Hausa	7778	Mongolian	8386	Swedish
6669	Byelorussian	7273	Hindi	7779	Moldavian	8387	Swahili
6671	Bulgarian	7282	Croatian	7782	Marathi	8465	Tamil
6672	Bihari	7285	Hungarian	7783	Malay	8469	Tagala
6678	Bengali; Bangla	7289	Armenian	7784	Maltese	8471	Tajik
6679	Tibeton	7365	Interlingua	7789	Burmese	8472	Thai
6682	Breton	7378	Indonesian	7865	Nauru	8473	Tigrinya
6765	Catalan	7383	Icelandic	7869	Nepali	8475	Turkmen
6779	Corsican	7384	Italian	7876	Dutch	8476	Tagalog
6783	Czech	7387	Hebrew	7879	Norwegian	8479	Tonga
6789	Welsh	7465	Japanese	7982	Oriya	8482	Turkish
6865	Danish	7473	Yiddish	8065	Panjabi	8484	Tatar
6869	German	7487	Javanese	8076	Polish	8487	Twi
6890	Bhutani	7565	Georgian	8083	Pashto, Pushto	8575	Ukranian
6976	Greek	7575	Kazakh	8084	Portuguese	8582	Urdu
6978	English	7576	Greenlandic	8185	Quechua	8590	Uzbek
6979	Esperanto	7577	Cambodian	8277	Raeto-Romance	8673	Vietnamese
6983	Spanish	7578	Kannada	8279	Romanian	8679	Volapük
6984	Estonian	7579	Korean	8285	Russian	8779	Wolof
6985	Basque	7583	Kashmiri	8365	Sanskrit	8872	Xhosa
7065	Persian	7585	Kurdish	8368	Sindhi	8979	Yoruba
7073	Finnish	7589	Kirghiz	8372	Serbo-Croatian	9072	Chinese
7074	Fiji	7665	Latin	8373	Singhalese	9085	Zulu

### 4-16-4.47 Warning and Instruction Displays

These displays will alert you to a missed operation or provide further instructions.

OSD	Caution	Section
<b>PLEASE SET CLOCK BY PRESSING ACTION KEY</b>	If you attempt to set or review a Timer Recording and the Clock is not set. . .	Timer Recording
<b>PLEASE PREPARE FOR TIMER REC</b>	If DECK is not in Stop mode or a cassette with record tab is not inserted 2 minutes before a Timer Recording is about to begin. . .	Timer Recording
<b>CHECK CASSETTE RECORD TAB</b>	If you press REC on the remote control or DECK, and a cassette is inserted with no record tab. .	Deck and Cassette Information
<b>NO CASSETTE</b>	If you press PLAY, FF, REW, or REC on the remote control or DECK without a cassette inserted. . .	Playback/record on a Tape
<b>TO CANCEL TIMER REC HOLD DOWN STOP KEY FOR APPROX 3 SEC</b>	If you press STOP or POWER during a Timer Recording. . .(visible in VCR mode only)	Review, Replace or Clear Program Contents
<b>VIDEO HEADS MAY NEED CLEANING PLEASE INSERT HEAD CLEANING CASSETTE OR REFER TO MANUAL END :PLAY</b>	If head cleaning becomes necessary while playing back a tape. . .	Deck and Cassette Information
<b>VCR LOCK ACTIVATED</b>	If you press a function button other than STOP/EJECT or POWER while DECK is in VCR Lock mode. . .	Special VCR Features
<b>REMOTE CONTROL IS SET TO TV MODE USE VCR : VCR KEY USE DVD : DVD KEY</b>	If you press an invalid key on the remote while in TV mode. . .	Multi-Brand Control Feature Special VCR Features
<b>PLEASE CHECK THE DISC, FOR STAINS OR SCRATCHES ON DISC</b>	If you press PLAY, and DECK reads data from a stained or scratched disc in DVD mode.	Before Using
<b>THIS DISC MAY NOT BE PLAYED IN YOUR REGION</b>	Playback of a disc with different region number was attempted. Only discs marked region "1", "ALL", or those that include "1" are playable on this DECK.	Safety Precautions
<b>THIS TYPE OF DISC CANNOT BE PLAYED, PLEASE INSERT A DIFFERENT DISC</b>	An unusable disc is inserted in the DECK.	Before Using
<b>CANNOT PLAY THIS FILE</b>	This file format cannot be played. (Appears during MP3/WMA/JPEG file playback)	MP3/WMA/JPEG Playback Operation
<b>THIS FILE IS PROTECTED</b>	This file is copyright protected and cannot be played back. (Playback is prohibited.)	MP3/WMA/JPEG Playback Operation
<b>IT IS PROHIBITED TO COPY DVD/VIDEO CD/CD TO VHS</b>	If you press REC in DVD mode. . .	Playback/record on a Tape

### 4-16.4.48 Before Requesting Service

Check the following points if you are having trouble with your deck.

<b>Power</b>	<b>Correction</b>
No power. . .	<ul style="list-style-type: none"> <li>• Completely insert Power Plug into an AC outlet.</li> <li>• Set POWER button to on.</li> <li>• Make sure power source is active.</li> </ul>
Power turns itself off. . .	<ul style="list-style-type: none"> <li>• Auto power-off (shutoff) occurs after about 5 min. in DVD mode with no operation, or if there is no broadcast signal in TV or Playback mode. Turn the power back on. (Refer to sections "Auto-Power Off Function" and "Auto-Shut-Off Feature".)</li> </ul>
<b>Recording &amp; Playback</b>	<b>Correction</b>
TV program cannot be recorded. . .	<ul style="list-style-type: none"> <li>• Check connections between DECK, external antenna, and TV.</li> <li>• Check channel selections.</li> <li>• Make sure your antenna system (CABLE or TV) is correctly set. (Refer to section "<a href="#">Reset Language, Channels, Clock</a>".)</li> <li>• Make sure cassette record tab is intact.</li> </ul>
Timer recording cannot be performed.	<ul style="list-style-type: none"> <li>• Confirm that clock is set to current time and date.</li> <li>• Make sure Cable/DSS box (if used) is left on and tuned to channel to be recorded.</li> <li>• Set recording start/stop times correctly. (See section "<a href="#">Timer Recording</a>".)</li> <li>• Timer recording may not be performed or continued if a power interruption occurs before or during a Timer Recording, even after power is restored.</li> </ul>
There is no playback picture, or the playback picture is noisy or contains streaks. . .	<ul style="list-style-type: none"> <li>• Select channel 3 or 4 on TV to match VCR output channel (3 or 4) (See section "<a href="#">Initial Setup for Basic Connections (Ready to Play)</a>").</li> <li>• Set VCR/TV selector to "VCR."</li> <li>• Adjust TRACKING control in either direction. (See "<a href="#">Features for a Quality Picture (VCR)</a>" section.)</li> <li>• Try Head Cleaning. (See "<a href="#">Features for a Quality Picture (VCR)</a>" section.)</li> </ul>
During special effects playback, picture may contain some vertical jitter when using a TV with an Automatic Vertical Hold Control. . .	<ul style="list-style-type: none"> <li>• Set TV's Vertical Hold Control to MANUAL, then adjust.</li> </ul>
DECK cannot be controlled. . .	<ul style="list-style-type: none"> <li>• Make sure DECK power is on.</li> <li>• Check Remote batteries.</li> <li>• Make sure VCR LOCK is set to off. (See section "<a href="#">VCR Lock Feature</a>".)</li> <li>• Make sure Remote is in proper mode. (See section "<a href="#">Multi-Brand Control Feature</a>".)</li> <li>• Make sure Timer Recording is not in progress.</li> </ul>
<b>Remote Control</b>	<b>Correction</b>
DECK cannot be remote controlled. . .	<ul style="list-style-type: none"> <li>• Make sure DECK power is on.</li> <li>• Make sure Remote is in VCR mode.</li> <li>• Aim Remote Control directly at remote sensor on DECK.</li> <li>• Avoid any object blocking signal path.</li> <li>• Check Remote batteries.</li> <li>• Exposing DECK remote sensor to direct fluorescent or outdoor light may cause signal interference.</li> </ul>
PROG buttons do not respond. . .	<ul style="list-style-type: none"> <li>• PROG functions are not available in COMPONENT Video Output and S-VIDEO OUT. Set TV to either RF IN or VIDEO IN. (See section "<a href="#">Location of Controls</a>".)</li> <li>• Check Remote batteries.</li> <li>• Press VCR or DVD button for DVD/VCR mode. (See section "<a href="#">Multi-Brand Control Feature</a>".)</li> </ul>

Check the following points if you are having trouble with your DECK.

DVD/Video CD/CD	Correction
Play fails to start even when PLAY is pressed. . .	<ul style="list-style-type: none"> <li>This DECK cannot play discs other than DVDs, Video CDs and CDs.</li> <li>The disc may be dirty and require cleaning.</li> </ul>
Play starts but then stops immediately. . .	<ul style="list-style-type: none"> <li>Be sure disc is installed with label side up.</li> </ul>
Picture is distorted during rapid advance or rapid reverse. . .	<ul style="list-style-type: none"> <li>The picture will be somewhat distorted at times: this is normal.</li> </ul>
No Forward/Reverse Scene Search play. . .	<ul style="list-style-type: none"> <li>Some discs may have sections which prohibit Forward/Reverse Scene Search. (See section "Basic DVD Operation".)</li> </ul>
Play does not start even when title is selected. . .	<ul style="list-style-type: none"> <li>Confirm the "DVD LOCK" setting. (See section "DVD Lock Feature".)</li> </ul>
Audio soundtrack and/or subtitle language is not the one selected at the initial settings. . .	<ul style="list-style-type: none"> <li>If the audio soundtrack and/or subtitle language selected at DVD initial settings does not exist on the disc, it will not be accessible</li> </ul>
No subtitles. . .	<ul style="list-style-type: none"> <li>Subtitles appear only when available on disc.</li> <li>"OFF" is selected at the changing subtitle language. Select "ON" at the "Subtitle Languages" section (See section "Subtitle Language (DVD Only)".) to display the subtitles.</li> </ul>
Alternative audio soundtrack (or subtitle) language cannot be selected. . .	<ul style="list-style-type: none"> <li>Alternative language cannot be selected with discs which do not contain more than one language.</li> <li>For some discs, alternative language cannot be selected with the AUDIO or SUBTITLE button. Try selecting it from the DVD MAIN MENU if available.</li> </ul>
Angle cannot be changed. . .	<ul style="list-style-type: none"> <li>This function is dependent on software availability. Even if disc has multiple angles, they may be recorded for specific scenes only (ANGLE indicator on DECK lights up). (See section "<a href="#">Multiple Angle Viewing (DVD only)</a>".)</li> </ul>
Miscellaneous	Correction
Programs cannot be viewed on TV. . .	<ul style="list-style-type: none"> <li>Make sure TV is set to output of DECK.</li> <li>Check connections between DECK, external antenna, and TV.</li> <li>Set VCR/TV selector to "TV." (See section "<a href="#">Playback/Record a Tape</a>".)</li> <li>Make sure proper signal source is selected.</li> </ul>
Video cassette cannot be inserted. . .	<ul style="list-style-type: none"> <li>Insert the cassette with window side up; record tab facing you.</li> </ul>
Video cassette ejects when a recording is started or the power is turned off for timer recording. . .	<ul style="list-style-type: none"> <li>Make sure cassette record tab is intact.</li> </ul>
In Stop mode, the motor (CYLINDER) continues to rotate. . .	<ul style="list-style-type: none"> <li>To enable Quick play mechanism, the cylinder will rotate for about 3 minutes. This reduces response time from Stop to Play mode.</li> </ul>
The disc cannot be removed. . .	<ul style="list-style-type: none"> <li>First, unplug DECK. Then, prepare a rigid wire (e.g. an extended paper clip) and, applying moderate force, insert it straight into the hole at the base of the tray. The tray will eject a little. Now, pull the tray all the way out and remove the disc.</li> </ul>

If you cannot resolve the problem, please call the Customer Call Center for product assistance at 1-800-211-PANA (7262).

Or to locate an authorized service center, please call toll free 1-800-211-PANA (7262).

Or send e-mail to: [consumerproducts@panasonic.com](mailto:consumerproducts@panasonic.com)

## 4-16.5 Panasonic AV Control Receiver

The 450 LXi comes with a Panasonic AV Control Receiver, basic operating and maintenance instructions can be found in this section. Any questions not covered in this manual may be answered by calling 1-800-211-PANA (7262) or <http://www.panasonic.com>.

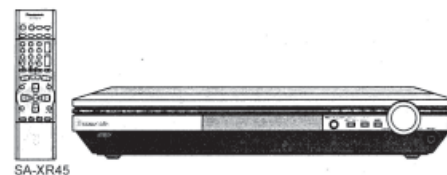

### 4-16.5.1 Important Safety Instructions

Read these operating instructions carefully before using the unit. Follow the safety instructions on the unit and the applicable safety instructions listed below. Keep these operating instructions handy for future reference.

- 1) Read these instructions.
- 2) Keep these instructions.
- 3) Heed all warnings.
- 4) Follow all instructions.
- 5) Do not use this apparatus near water.
- 6) Clean only with dry cloth.
- 7) Do not block any ventilation openings. Install in accordance with the manufacturer's instructions.
- 8) Do not install near any heat sources such as radiators, heat registers, stoves, or other apparatus (including amplifiers) that produce heat.
- 9) Do not defeat the safety purpose of the polarized or grounding-type plug. A polarized plug has two blades with one wider than the other. A grounding-type plug has two blades and a third grounding prong. The wide blade or the third prong are provided for your safety. If the provided plug does not fit into your outlet, consult an electrician for replacement of the obsolete outlet.
- 10) Protect the power cord from being walked on or pinched particularly at plugs, convenience receptacles, and the point where they exit from the apparatus.
- 11) Only use attachments/accessories specified by the manufacturer.
- 12) Use only with the cart, stand, tripod, bracket, or table specified by the manufacturer, or sold with the apparatus. When a cart is used, use caution when moving the cart/apparatus combination to avoid injury from tip-over.
- 13) Unplug this apparatus during lightning storms or when unused for long periods of time.
- 14) Refer all servicing to qualified service personnel. Servicing is required when the apparatus has been damaged in any way, such as power-supply cord or plug is damaged, liquid has been spilled or objects have fallen into the apparatus, the apparatus has been exposed to rain or moisture, does not operate normally, or has been dropped.

#### CAUTION!!

#### THE FOLLOWING ONLY APPLIES IN THE U.S.A.

The equipment has been tested and found to comply with the limits for a Class B digital device, pursuant to Part 15 of the FCC Rules.

These limits are designed to provide reasonable protection against harmful interference in a residential installation. This equipment generates, uses and can radiate radio frequency energy and, if not installed and used in accordance with the instructions, may cause harmful interference to radio communications. However, there is no guarantee that interference will not occur in a particular installation. If this equipment does cause harmful interference to radio or television reception, which can be determined by turning the equipment off and on, the user is encouraged to try to correct the interference by one or more of the following measures:

- Reorient or relocate the receiving antenna.
- Increase the separation between the equipment and receiver.
- Connect the equipment into an outlet on a circuit different from that to which the receiver is connected.
- Consult the dealer or an experienced radio/TV technician for help.

Any unauthorized changes or modifications to this equipment would void the user's authority to operate this device.

This device complies with Part 15 of the FCC Rules. Operation is subject to the following two conditions: (1) This device may not cause harmful interference, and (2) this device must accept any interference received, including interference that may cause undesired operation.

**LISTENING CAUTION:** Selecting fine audio equipment such as this unit is only the start of your musical enjoyment. Now it's time to consider how you can maximize the fun and excitement your equipment offers. This manufacturer and the Electronic Industries Association's Consumer Electronics Group want you to get the most out of your equipment by playing it at a safe level. One that lets the sound come through loud and clear without annoying blaring or distortion - and, most importantly, without affecting your sensitive hearing.

We recommend that you avoid prolonged exposure to excessive noise.

Sound can be deceiving. Over time your hearing "comfort level" adapts to higher volumes of sound. So what sounds "normal" can actually be loud and harmful to your hearing.

Guard against this by setting your equipment at a safe level BEFORE your hearing adapts.

**To establish a safe level:**

- Start your volume control at a low setting.
- Slowly increase the sound until you can hear it comfortably and clearly, and without distortion.

**Once you have established a comfortable sound level:**

- Set the dial and leave it there.

*Taking a minute to do this now will help to prevent hearing damage or loss in the future. After all, we want you listening for a lifetime.*

**WARNING!!**

To reduce the risk of fire, electric shock or product damage, do not expose this apparatus to rain, moisture, dripping or splashing and ensure that no objects filled with liquids, such as vases, will be placed on the apparatus.

**CAUTION!!**

Do not install or place this unit in a bookcase, built-in cabinet or in another confined space. Ensure the unit is well ventilated. To prevent risk of electric shock or fire hazard due to overheating, ensure that curtains and any other materials do not obstruct the ventilation vents.

### 4-16.5.2 The Remote Control

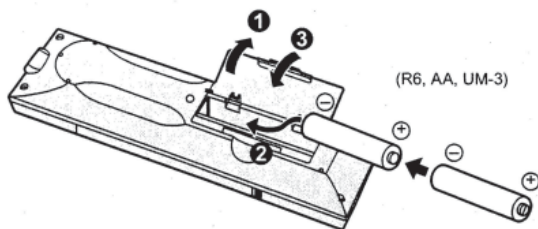

**Batteries**

- Insert so the poles (+ and -) match those in the remote control.
- Do not use rechargeable type batteries

**Use**

Aim at the sensor, avoiding obstacles, at a maximum range of 7m (23 feet) directly in front of the unit.

- Keep the transmission window and the unit's sensor free from dust.
- Operation can be affected by strong light sources, such as direct sunlight, and the glass doors on cabinets.

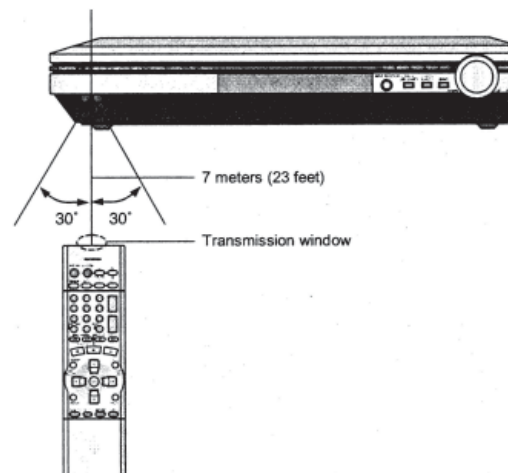

**How to Open the Remote Control**

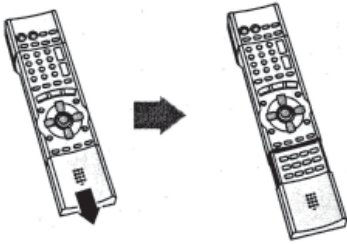

**Placement of Speakers**

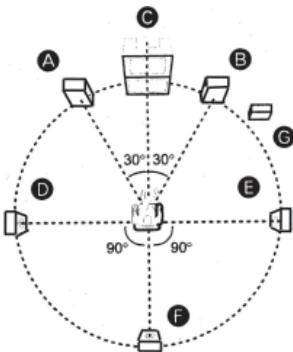

The front, center, and surround speakers should be placed at approximately the same distance from the seating area. The angles in the diagram are approximate.

**Front Speakers (A left B right)**

Place speakers on the left and right of the TV at seated ear height so that there is good coherency between the picture and sound.

**Center Speaker (C)**

Place underneath or above the center of the TV. Aim the speaker at the seating area.

**Surround Speakers (D left E right)**

Place on the side of or slightly behind the seating area, about one meter (3 feet) higher than ear level.

**Surround Back Speaker (F)**

Place behind the seating area, about one meter (3 feet) higher than ear level.

**Subwoofer (G)**

The subwoofer can be placed in any position as long as it is at a reasonable distance from the TV.

**NOTE:** Some experimentation can yield the smoothest low frequency performed. Placement near a corner can increase the apparent output level, but can result in unnatural bass.

**Speaker Cable**

Cable	Speaker terminals	Note	If using 4-mm plugs
<p>Twist the wire</p>	<p><b>FRONT</b></p> <p><b>Other terminals</b></p>	<p><b>Do not short-circuit.</b></p>	<p>Fully tighten the terminal, then insert.</p>



### 4-16.5.3 Speaker Connections

Peripheral equipment and cables sold separately unless otherwise indicated.

#### Connecting Speakers

Turn off the receiver before connecting the speakers.

Other connections are possible depending on your speaker system.

See your speaker system's operating instructions for details.

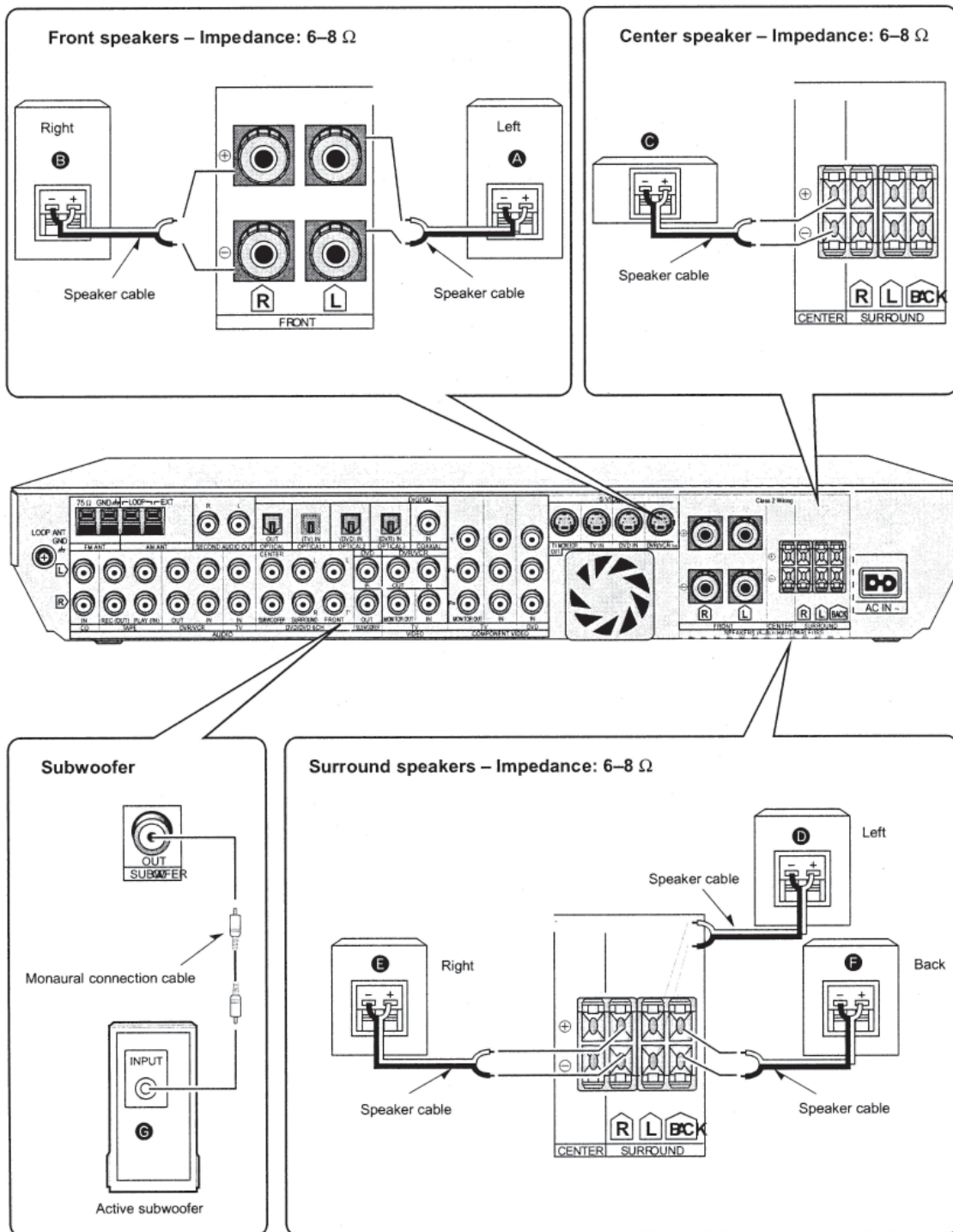

### 4-16.5.4 Equipment Connections

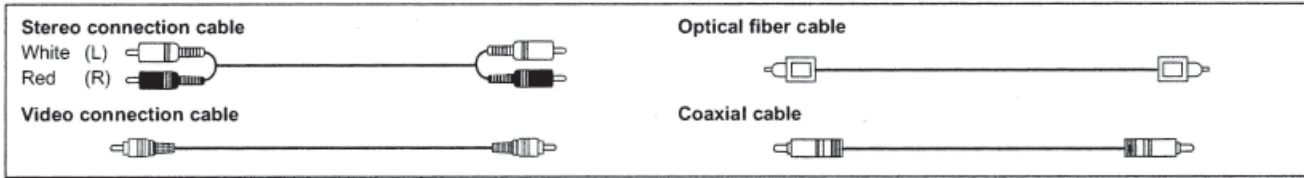

Turn off all components before making any connections. To connect equipment, refer to the appropriate operating instructions.



**NOTES:**

- Do not bend the optical fiber cable.
- Use digital connection to enjoy Dolby Digital or DTS (refer to *Basic Operations* section later in manual.)
- Use analog connection to enjoy sources that cannot be decoded on this unit, to record analog sources and to output through SECOND AUDIO OUT (SA-XR45) (Sections Using the Second Audio Out Terminal, Basic Operations and Other Settings).

**Changing the Digital Input Settings**

You can change the input settings for the digital terminals if necessary. Note the equipment you have connected to the terminals, then change the settings. (refer to sections *D-Input and Digital Input* found later in manual.)

### TV and DVD Player

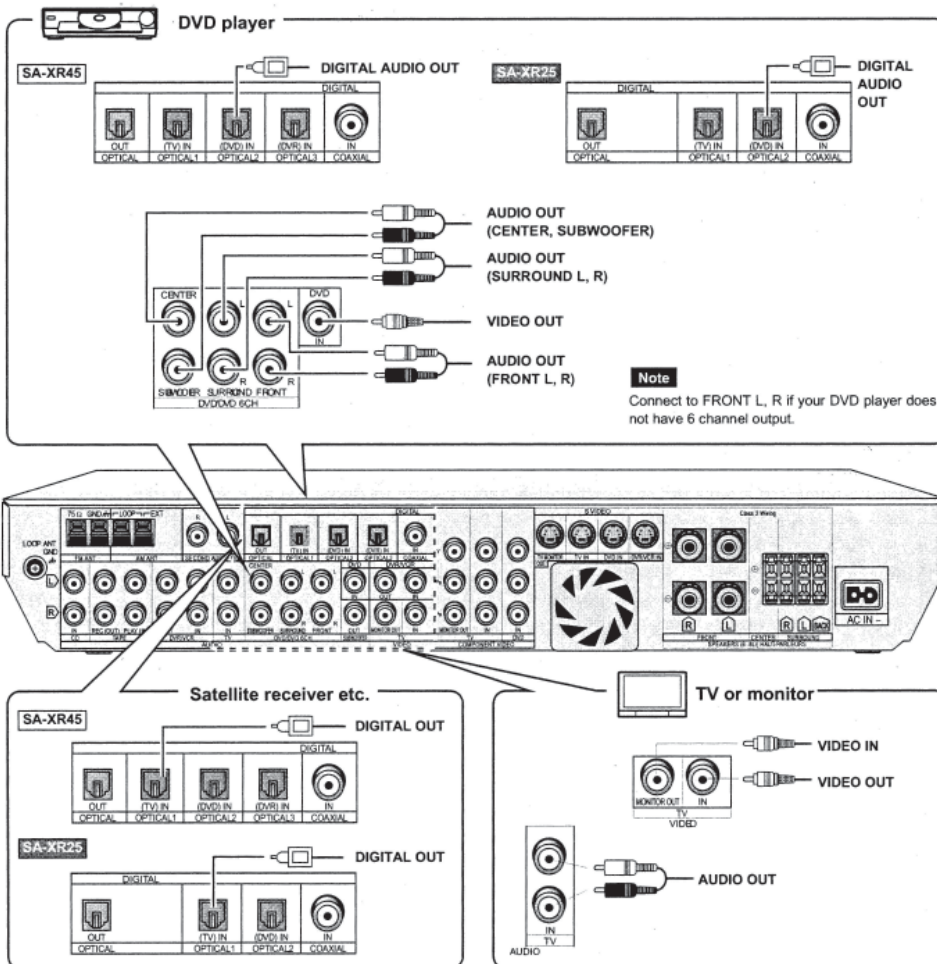

Other Audio Visual Equipment

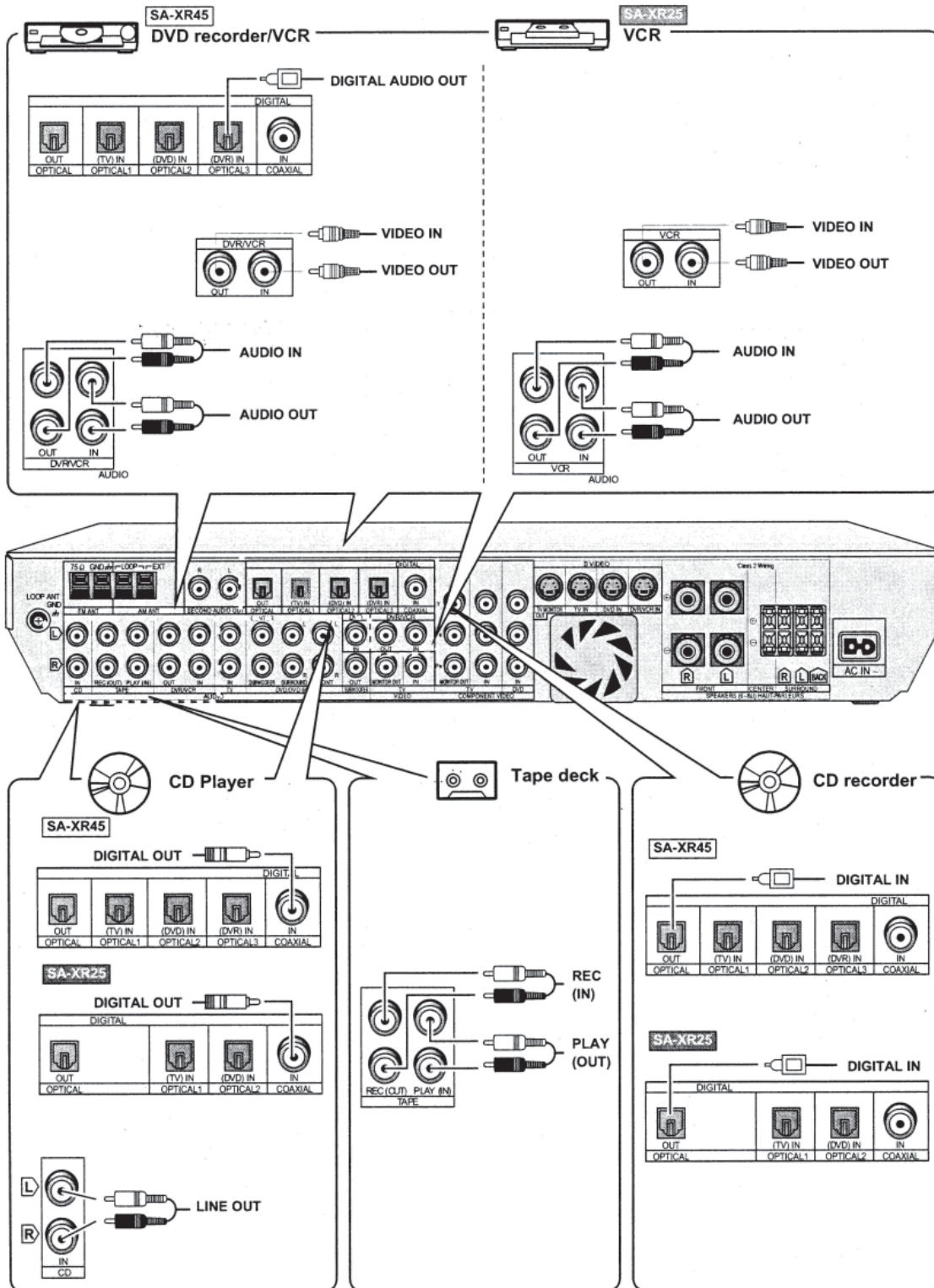

**Antennas**

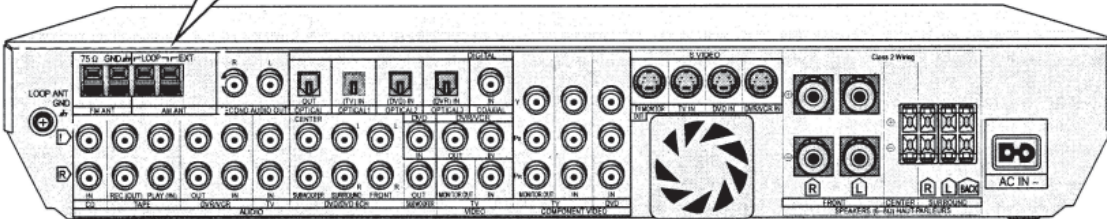
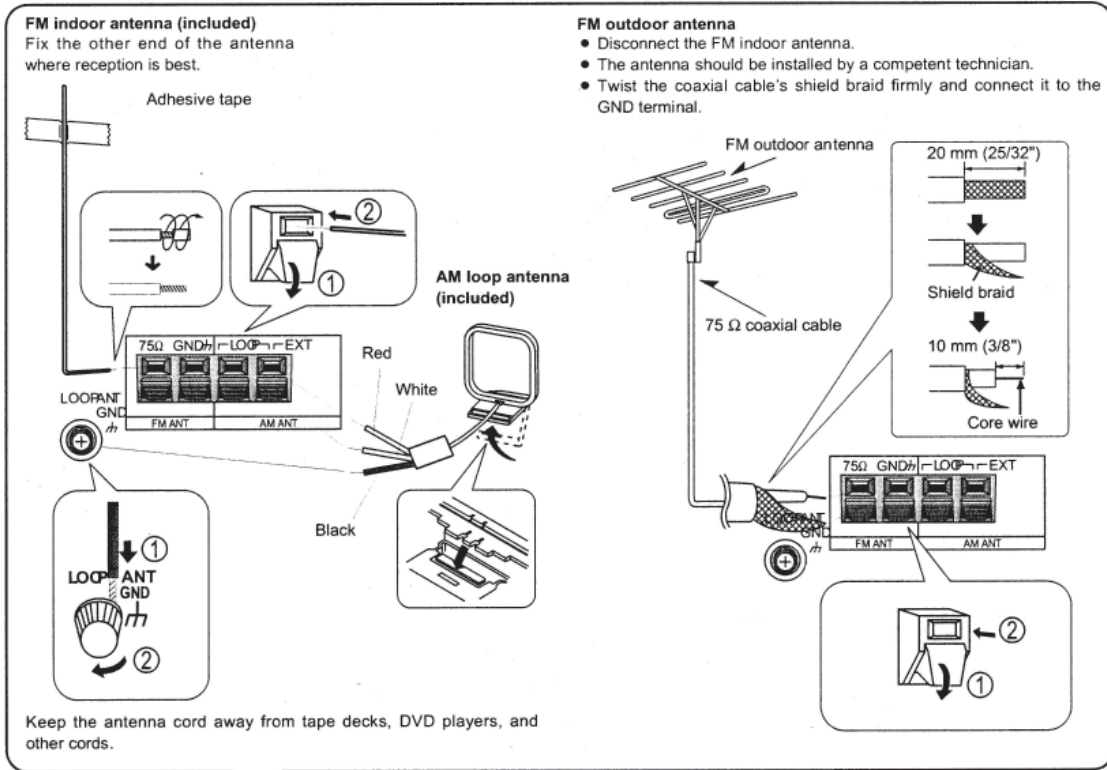

**Using the Second Audio Out Terminal**

Use SECOND AUDIO OUT to connect a stereo amplifier in another room. Choose whether to output the audio of the source playing on this unit or audio from another source (See *"SECOND-A"* or *"Second Audio Output"* sections.)

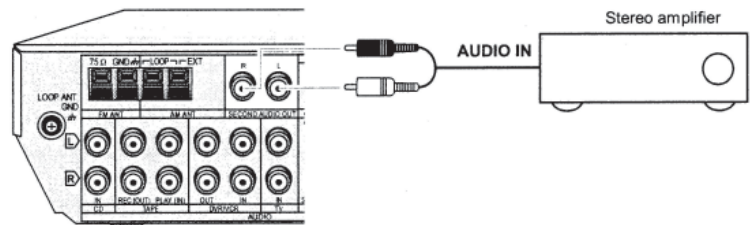

- NOTES:**
- Connect the source to analog terminals. You cannot output sources connected only to the digital terminals.
  - When you connect DVD 6CH input, only sound from the front left and right channels is output.

### Other Video Connections

**COMPONENT VIDEO**

This connection provides high quality pictures by separating the color (Pb and Pr) and the luminance (Y) signals.

**S VIDEO**

Use this connection for better picture quality than with the VIDEO terminals.

**Note**

Video input can only be output again through the same type of terminal.

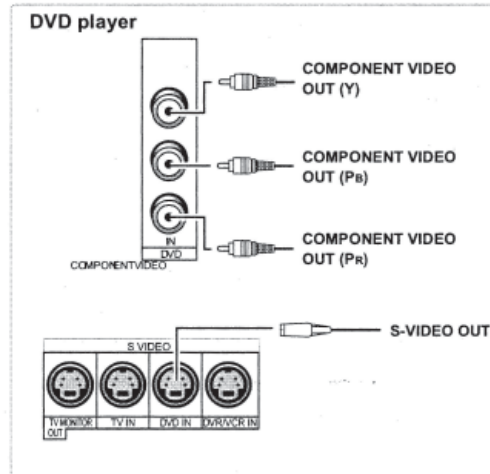
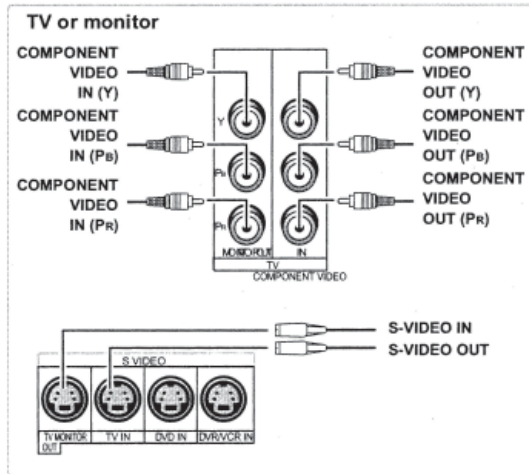
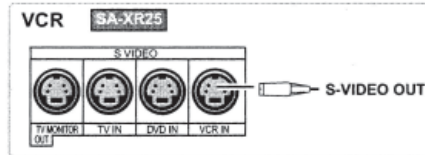
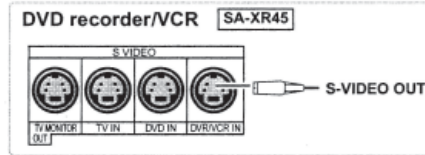
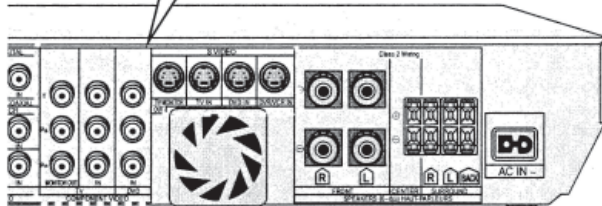
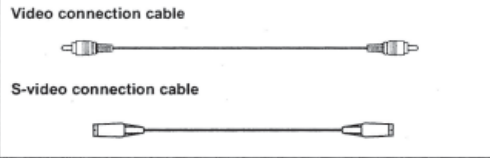

### Connecting the AC Power Supply Cord and Other Information

The cooling fan operates at high power output levels only.

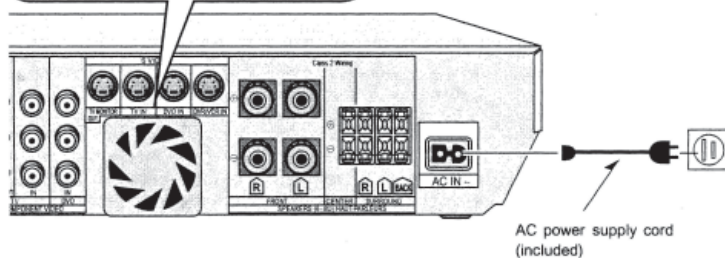

**CAUTION!!** To prevent electric shock match wide blade of plug to wide slot, fully insert.

Connect this cord after all other cables and cords  
Household AC outlet (AC 120 V/60 Hz)

**NOTE:** The included AC power supply cord is for use with this unit only. Do not use it with other equipment.

### Conserving Power

The unit consumes 1W even when it is turned off with [Power  $\phi$ /I ]. To save power when the unit is not to be used for a long time, unplug it from the household AC outlet.

If the unit is left unplugged for longer than a few weeks, all settings will revert to the factory settings. The settings will have to be reset if this occurs.

### 4-16.5.5 Settings

SA-XR45 also has an On Screen Display Mode for settings 1 to 4 (See "Settings On Screen Display Mode" later in manual.)

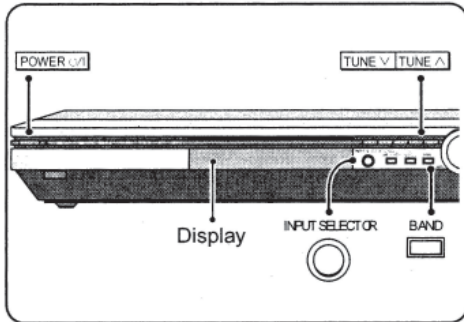

#### 1 SPEAKERS

#### 2 DISTANCE

Set the size to suit your speakers

**LARGE:** For speakers that can reproduce a full sound range, particularly the bass range below 100 Hz.

**SMALL:** For speakers that cannot adequately reproduce the bass range. This setting is sufficient for most speakers if you are using a subwoofer.

**NONE:** For speakers you haven't connected (center or surround). The factory settings are: **SMALL**

For the surround back (SUR BACK) and subwoofer (SUB-WFR), select YES if you have connected one (factory setting), or NO if you have not.

Enter the distance of the front, center and surround speakers from the seating position

Change the distance so that the sound from all the speakers (except for the subwoofer) reaches you at the same time.

You can select distances between 3 and 30 feet at one-foot intervals.

The factory settings are:  
**FRONT and CENTER: 10 FEET**  
**SURROUND and SUR BACK: 5 FEET**

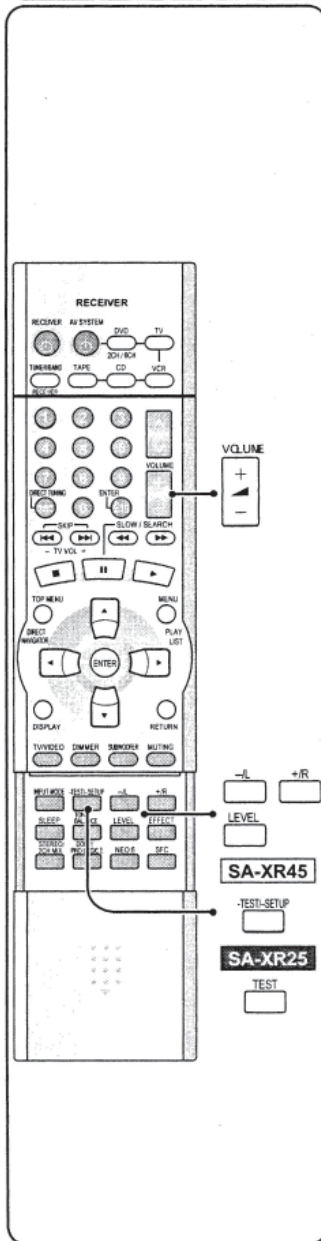

Switch on

Press at the same time

Press at the same time

Enter the setting mode.

Select "SPEAKERS".

Select "DISTANCE".

**SPEAKERS**

**DISTANCE**

Select the speaker.

Select the speaker.

**FRONT**

**FRONT**

FRONT, CENTER, SURROUND, SUR BACK, SUB-WFR

FRONT, CENTER, SURROUND, SUR BACK

Repeat.

Repeat.

Change the setting.

Change the setting.

**SMALL**

**10 FEET**

NONE, SMALL, LARGE NO, YES

3 FEET — 30 FEET

Exit the setting mode.

Change the settings to suit your equipment to the environment in which you are using it. Before making any changes, read the descriptions of the settings, note the factory settings and ranges, and refer to the equipment's instructions.

**3 FILTER**

**Change the cut-off for bass output from the front speakers**

If you set the front speakers to "SMALL", the filter is set to 100 Hz. Raise the cut-off if the bass from the front speakers is unsatisfactory so that this bass is output through the subwoofer. You can raise the cut-off from 100 Hz to either 150 Hz or 200 Hz.

**4 D-INPUT**  
Digital input

Change these settings to suit the connections you have made to the optical (OPT) and coaxial (COAX) digital input terminals, so that the correct source is selected when you press [INPUT SELECTOR].

The factory settings are:

	SA-XR45	SA-XR25
TV:	OPT 1	OPT 1
DVD:	OPT 2	OPT 2
DVR:	OPT 3	CD
CD:	COAX	COAX

**5 Adjusting speaker output level**

Adjust the level of the other speakers based on the output of the front speakers. (Speakers set as "NONE" or "NO" are skipped. Adjust the volume of the front speakers with [VOLUME].)

C (center), RS (right surround), SB (surround back) and LS (left surround) can be adjusted between -10 dB and +10 dB, with 0 being the level of the front speakers. Adjust center, surround and surround back output to the same apparent level of the front speakers.

For SW (subwoofer), you can select "--" so there is no output, "MIN" for minimum output, a level between 1 and 19, or "MAX" for maximum output.

Adjust subwoofer output so it is balanced with the front speakers. Subwoofer output is easily influenced by the source. You can also change its level while playing something for better effect (→ page 18).

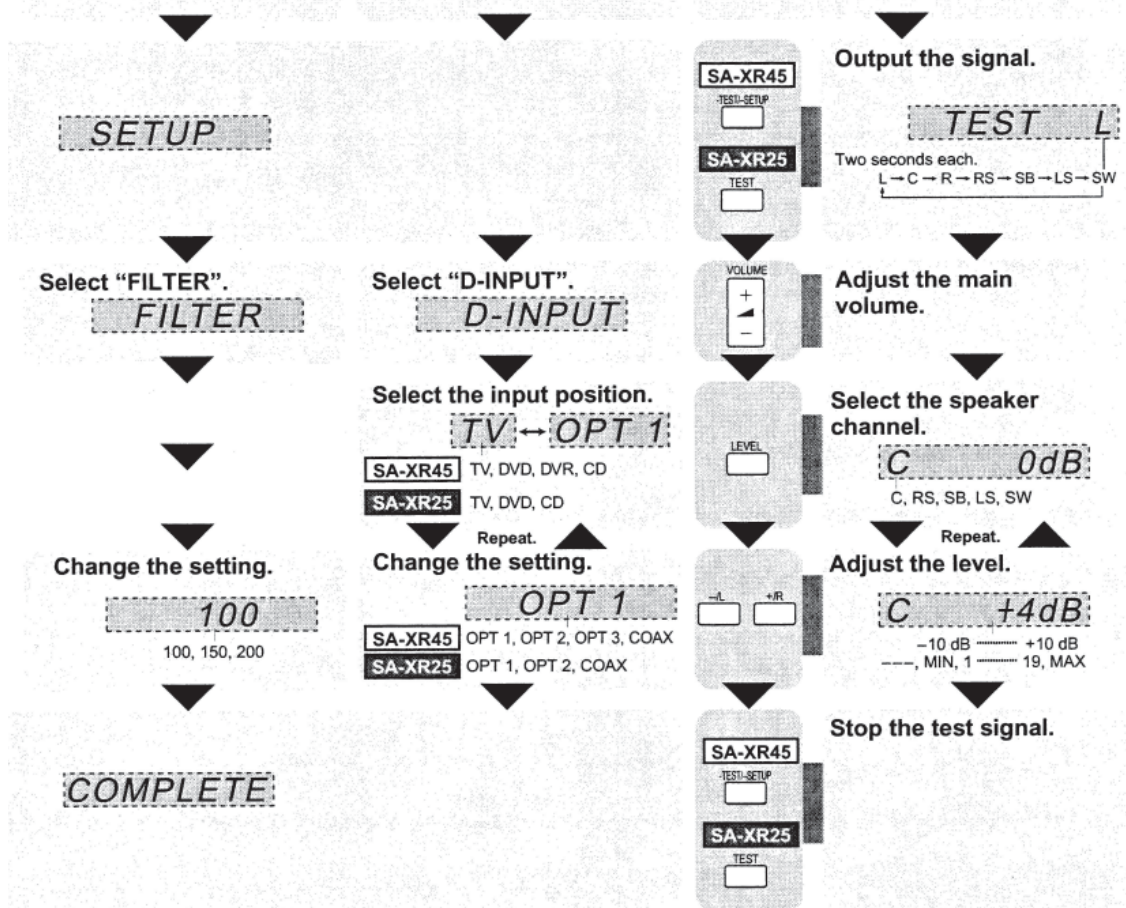

### 4-16.5.6 Settings On Screen Display Mode

- Use the on screen display to change the settings to suit your equipment to the environment in which you are using it. Turn on the television and select the video input for this unit.
- Before making any changes, read the descriptions of the settings, note the factory settings and ranges, and refer to the equipment's instructions.

#### To exit On Screen Display Mode

Select "Exit from SETUP" in the main menu.



Or

Press [RETURN] until the setup menu disappears.

#### For Your Reference

- To return to the main menu: Select "Return" or Press [RETURN]
- Follow Step #5 Adjusting Speaker Output Level found previously to adjust speaker output level.

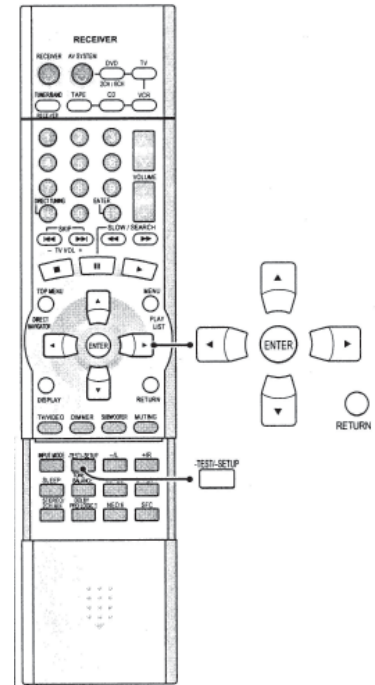

### 1 Speaker Size

Set the size to suit your speakers

- LARGE:** For speakers that can reproduce a full sound range, particularly the bass range below 100 Hz.
  - SMALL:** For speakers that cannot adequately reproduce the bass range. This setting is sufficient for most speakers if you are using a subwoofer.
  - NONE:** For speakers you haven't connected (center or surround).
- The factory settings are: **SMALL**

For the surround back (Surr Back) and subwoofer (Subwoofer), select YES if you have connected one (factory setting), or NO if you have not.

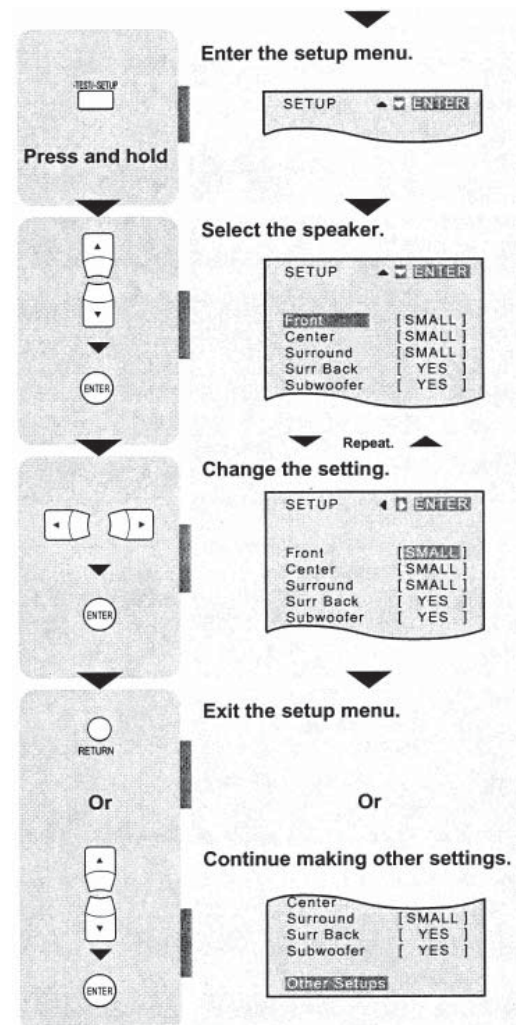



## 2 Speaker Distance

Enter the distance of the front, center and surround speakers from the seating position.

Change the distance so that the sound from all the speakers (except for the subwoofer) reaches you at the same time. You can select distances between 3 and 30 feet at one-foot intervals.

The factory settings are:

Front and Center: 10 FEET  
Surround and Surr Back: 5 FEET

## 3 Filter Frequency

Change the cut-off bass for output from the front speakers.

If you set the front speakers to "SMALL", the filter is set to 100 Hz. Raise the cut-off if the bass from the front speakers is unsatisfactory so bass is output through the subwoofer.

You can raise the cut-off from 100 Hz to either 150 Hz or 200 Hz.

## 4 Digital Input

Change these settings to suit the connections you have made to the optical (OPT) and coaxial (COAX) digital input terminals, so that the correct source is selected when you press [INPUT SELECTOR].

CD: TV: DVD: DVR:  
COAX [OPT1]  
OPT1 [OPT2]  
OPT2 [OPT3]  
OPT3

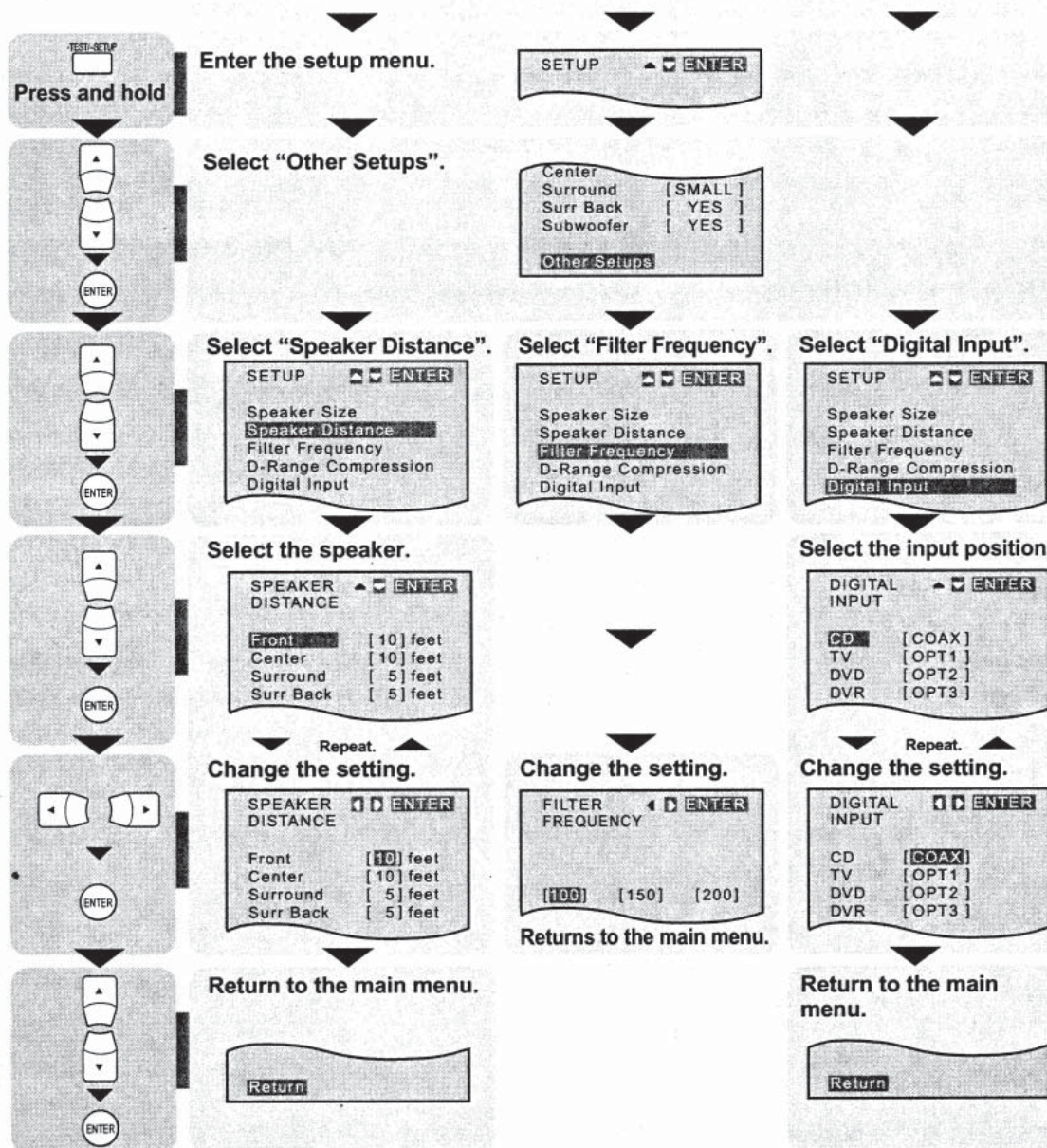



## Sound Modes

The unit sets the sound mode to suit the signal.

### Adding Surround Effects to Stereo Sources

#### Using Dolby Pro Logic II

Dolby Pro Logic II processor works not only on sources recorded with Dolby Surround, but also on any stereo source. The following modes are available when using Dolby Pro Logic II.

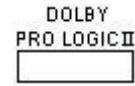

#### **MOVIE**

Use this mode when playing movie software, especially videotapes, recorded in Dolby Surround.

#### **MUSIC**

Adds surround effects to stereo sources.

#### **PANORAMA**

Sound is spread out more so you feel like you are surrounded by music.

You can adjust the effect of MUSIC and PANORAMA with the center width and dimension controls.

#### **Center Width Control - C-WDTH**

This adjustment helps you realize a more natural sound image when listening to music. Move sound out into the front speakers to improve the overall front image, or add sound to the center speaker to fix the center image. You can choose a level between 0 (the center speaker is dominant) and 7 (center sound is spread out). The default level is 3.

1. Press [EFFECT] to select "C-WDTH"
2. Press [-L] or [+R] to adjust the effect.

#### **Dimension Control - DIMEN**

You can make up for differences in the output level of the front and surround speakers. You can choose a level between -3 and +3 - increases the level to move sound to the front speakers, decrease to move it to the surround speakers. The default level is 0.

1. Press [EFFECT] to select "DIMEN"
2. Press [-L] or [+R] to adjust the effect.

#### Using NEO:6

Use NEO:6 to play 2-channel sources through multi-channels. The following modes are available when playing 2-channel sources.



#### **CINEMA**

Use this mode when playing movie software.

#### **MUSIC**

Adds surround effects to stereo sources.

#### **Notes on using NEO:6**

You cannot select the above modes when the "DTS" or ■■ DIGITAL" indicator is on.

You can adjust the effect of MUSIC with the center image control.

#### **Center Image Control - C-IMG**

This adjustment helps you realize a more natural sound image when listening to music. Move sound out into the front speakers to improve the overall front image, or add sound to the center speaker to fix the center image. You can choose a level between 0 (the center speaker is dominant) and 5 (center sound is spread out). The default level is 3.

1. Press [EFFECT] to select "C-IMG".
2. Press [-L] or [+R] to adjust the effect.

### Using the Sound Field Control (SFC)

Enjoy an enhanced sound experience with greater presence and spread by using these SFC modes  with PCM or analog stereo sources.

Choose from the following modes.

#### HALL

Imparts the reflection and spread of a large concert hall.

#### CLUB

Conveys the exciting and intimate atmosphere of a jazz club.

#### LIVE

Brings you up close for “live” stage performance and smoother vocals.

#### THEATER

Recreates natural sound ambience and direction.

#### SIM SURR (Simulated Surround)

Heightens the sensation of expanded space with stereo sources, and augments monaural sources.

#### PARTY

This mode uses the front and surround speakers so that sound is in stereo regardless of the direction you’re facing.

You can adjust the sound field by adjusting the level of the speakers and the delay time of the surround speakers. These adjustments can be made for each SFC mode.

#### To adjust the speaker level

Press [LEVEL] to select the speaker channel.

Each time you press the button:

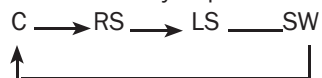

Sound does not come from the surround back speaker.

Speakers set as “NONE” or “NO” or skipped.

1. Press [-L] or [+R] to adjust the level.

C, RS, and LS: -10 dB to +10 dB

SW: —(off) ↔ MN ↔ 1-19 ↔ MAX

#### To adjust the delay time

1. Press [EFFECT].
2. Press [-L] or [+R] to change the delay time.  
Delay time can be set at 10-millisecond (ms) intervals between 10 and 100 ms.  
The factory setting is 50 ms for each mode.

Dolby Pro Logic II, NEO:6 and SFC modes remain in effect until you change them.

To return to stereo sound - Press [STEREO/2CH MIX].

### Enhanced Surround Mode

This mode uses the surround back speaker to create a realistic sound field. It is especially effective when playing DTS-ES and Dolby Digital Surround EX, but can be used with other DTS and Dolby Digital sources, as well as Dolby Pro Logic II and NEO:6. This mode engages automatically if the disc has a recognition signal for DTS-ES or Dolby Digital Surround EX (you can still turn the mode off).

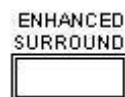

### Listening to Multi-Channel Sources in Stereo

When surround sources are played in this mode, the sounds intended for the other speaker channels are played through the front speakers.

The 2CH MIX mode remains in effect until you change input mode or turn off the unit.

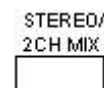

**To return to surround sound** - Press [STEREO/2CH MIX].

**If the unit does not automatically recognize Dolby Digital Surround EX or DTS-ES and output is 5.1 channels:**

Press [ENHANCED SURROUND] to switch the mode on manually. Sound will now come from the surround back speaker.

**For your reference**

In rare cases, the unit may have trouble recognizing the digital signals on discs.

- With the PCM signals on CDs, this may cause the beginning of a track to be cut off. Engage the PCM FIX mode if this occurs.
- With DTS, the signals may not be recognized at all. Engage the DTS FIX mode if this occurs.

While the input source is selected:

1. Press [INPUT MODE] to select "DIGITAL"
2. Press and hold [INPUT MODE] for four seconds.

The current mode is displayed. Press again to change the mode.

Each time you press the button:

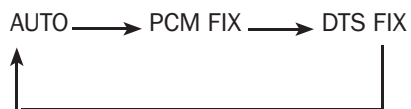

When a FIX mode is on, the unit cannot process other signals. This may cause noise to be output. Select "AUTO" if this occurs.

The mode returns to AUTO when you switch the unit to standby.

- **When DTS FIX mode is on**

You cannot use ENHANCED SURROUND.

DTS-ES and DTS 96/24 (SA-XR45) are played as normal DTS (i.e., there is no output from the surround back speaker.)

### 4-16.5.7 Control Guide

Main Unit

[ ■ ■ DIGITAL EX, ■ ■ DIGITAL, ■ ■ PL II, DTS 96/24, DTS-ES, DTS, NEO:6 ] ( SA-XR45 )

[ ■ ■ DIGITAL EX, ■ ■ DIGITAL, ■ ■ PL II, DTS-ES, DTS, NEO:6 ] ( SA-XR25 )

Light to indicate the source's input signal and decoding format used.

■ ■ **DIGITAL EX:** Dolby Digital Surround EX sources

■ ■ **DIGITAL:** Dolby Digital Sources

■ ■ **PLII:** Dolby Pro Logic II decoder is being used

DTS 96/24: DTS 96/24 sources ( SA-XR45 )

DTS-ES: DTS-ES discrete or matrix sources

DTS: DTS sources

NEO:6: NEO:6 matrix decoder is being used

[ **POWER** ⏻ ]

Press to switch the unit from on to standby mode or vice versa.

In standby mode, the unit is still consuming a small amount of power.

Standby indicator [ ⏻ ]

When the unit is connected to the AC main supply, this indicator lights up in standby mode and goes out when the unit is turned on.

**Remote control signal sensor**

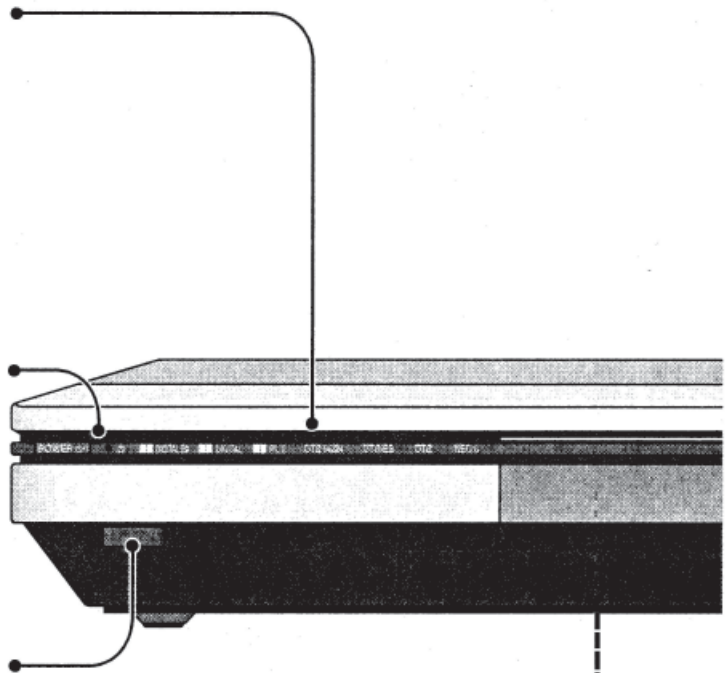

### Display

[ **SLEEP** ] Sleep timer indicator.

[ **M** , **TUNED** , **ST** , **MONO** ]

Radio indicators

**M** : Flashes or lights during presetting.

**TUNED:** A station is tuned.

**ST:** A stereo FM broadcast is tuned.

**MONO:** You have switched to monaural mode with [FM MODE] to improve reception.

### General Display

Shows the input mode, radio frequency, and other general information.

[ kHz, MHz ]

Frequency unit indicators

kHz: AM, or PCM sampling frequency

MHz: FM

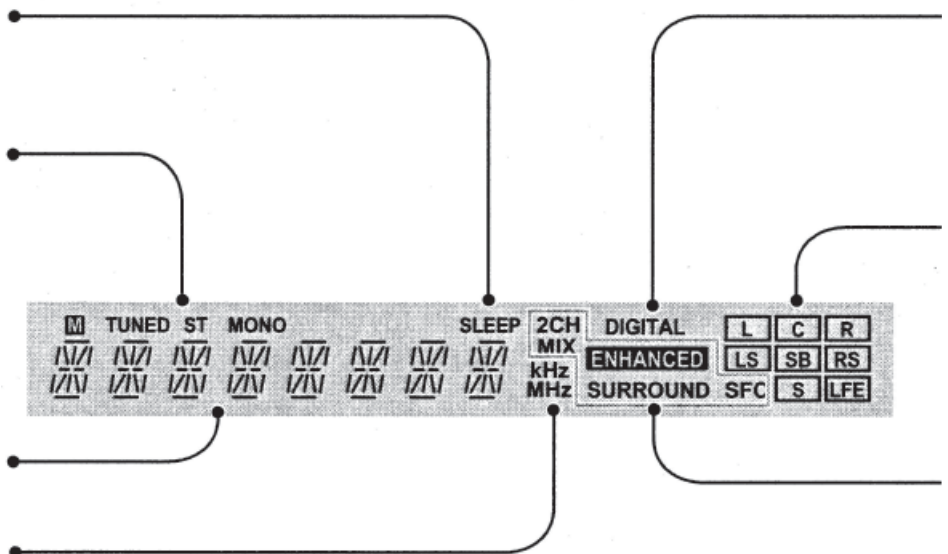

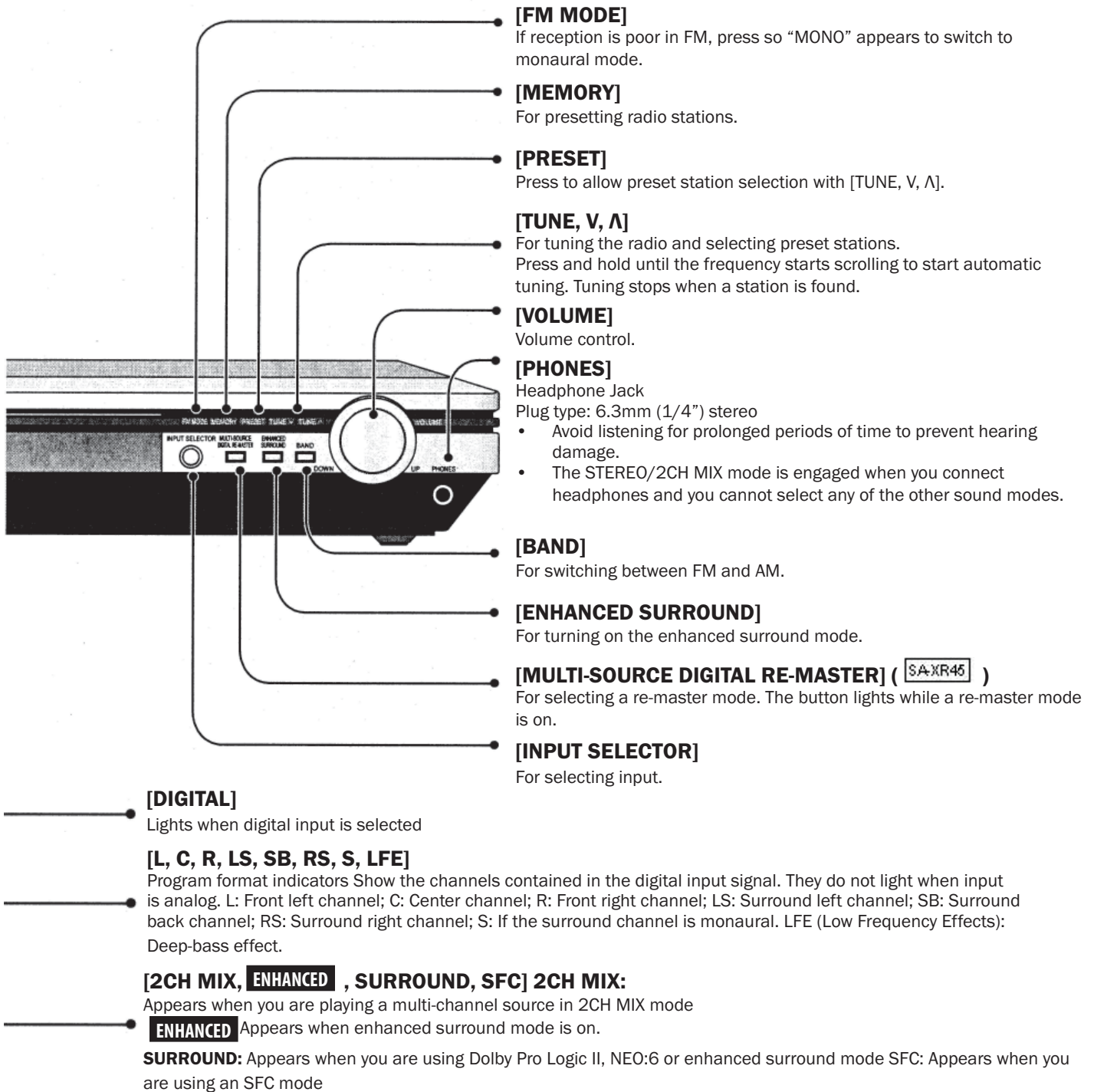
**For your reference**

- When playing video sources connected to DVR/VCR (SA-XR45) or VCR (SA-XR-25) The picture remains on the screen even if you select TAPE, CD or TUNER.

Manufactured under license from Dolby Laboratories. "Dolby", "Pro Logic" and the double-D symbol are trademarks of Dolby Laboratories.

Manufactured under license from Digital Theater Systems, Inc. US Pat. No. 5,451,942, 5,956,674, 5,974,380, 5,978,762 and other world-wide patents issued and pending. "DTS", "DTS-ES Extended Surround" and "Neo:6" are trademarks of Digital Theater Systems, Inc. Copyright 1996, 2000 Digital Theater Systems, Inc. All rights reserved.

**REMOTE CONTROL**

Buttons not explained on this page are used only to operate other equipment. Refer to the separate *Remote Control Operation Guide* for details.

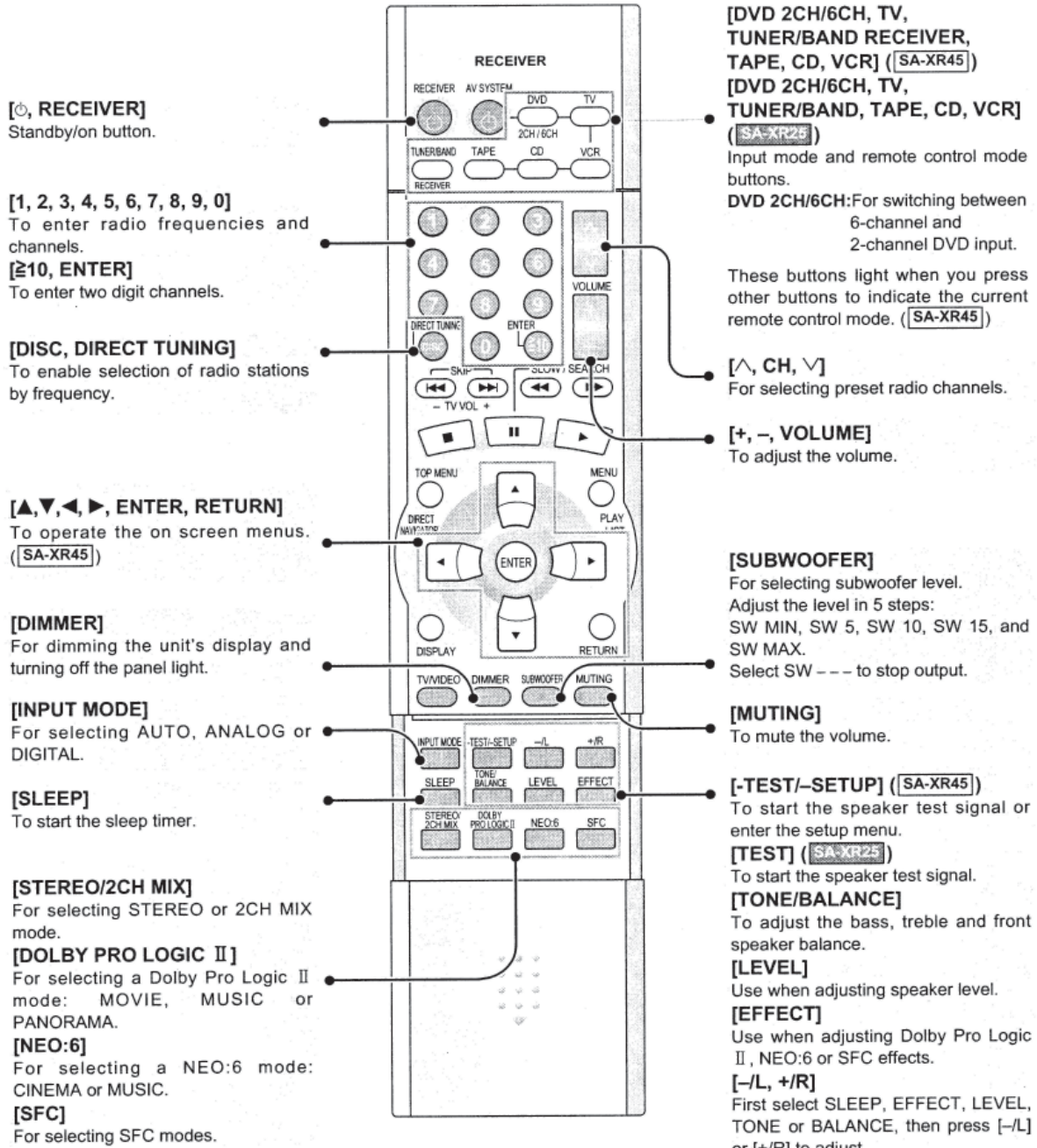

**For your reference**

- **When DVD 6CH input is on**  
Speaker settings are ineffective. Change the settings on the DVD player if necessary.
- **When using the subwoofer**  
You cannot adjust subwoofer level if DVD 6CH INPUT is selected.  
Sound can be distorted if you raise the volume while subwoofer level is high. Reduce subwoofer level if this occurs.
- **When muting is on**  
Muting is also canceled when the unit is turned off.



### 4-16.5.8 The Radio

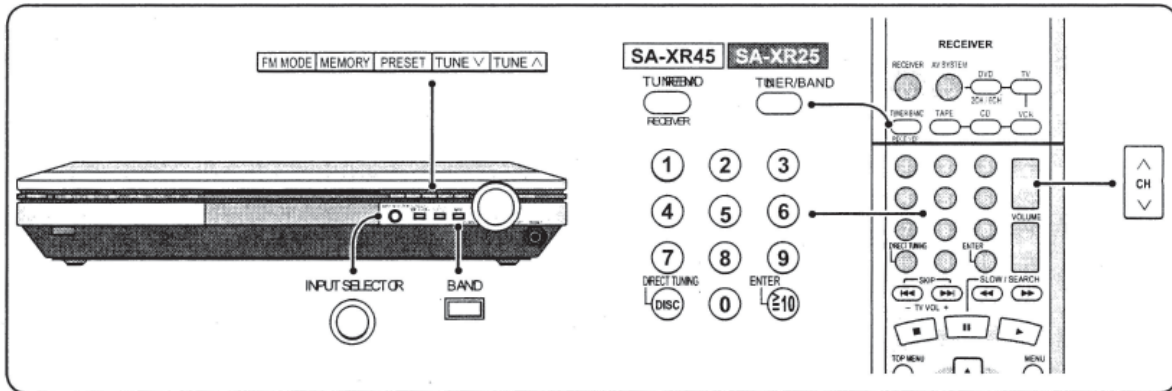

#### Manual Tuning

You can tune radio stations manually by selecting the station's frequency.

1. Press [INPUT SELECTOR] to select "TUNER".
2. Press [BAND] to select "FM" or "AM".
3. Press [TUNE V or A] to select the frequency.

Tuning intervals: FM - 0.2 MHz  
AM - 10 kHz

#### Improving Reception

- FM Mode - You can improve FM reception by switching reception to monaural. Press [FM MODE]. "MONO" lights. Press [FM MODE] again to cancel.

**For Your Reference** - DVD players can interfere with radio reception. Turn the DVD player off or move it further away from the antennas if this occurs.

#### Direct Tuning (on the remote control)

1. Press [TUNER/BAND RECEIVER]. (SA-XR45)
2. Press [TUNER/BAND]. (SA-XR25)  
The band changes each time you press the button.
3. Press [DISC, DIRECT TUNING].
4. Press the numbered buttons to enter the frequency.  
e.g. To select 107.9 MHz, press [1] → [0] → [7] → [9]  
Tuning intervals: FM - 0.1 MHz  
AM - 10 kHz

- If you do not press a button while the cursor is flashing, the display returns to the frequency being received.
- If the frequency has not been input correctly, "ERROR" will be displayed.

#### Automatic Presetting

1. Tune to "FM 87.9 MHz".
2. Press and hold [MEMORY].  
The FM stations the unit can receive are preset in channels 1 to 30.
3. Tune to "AM 530 kHz".
4. Press and hold [MEMORY].  
The AM stations the unit can receive are preset in channels 21 to 30. (FM stations are replaced if any were preset in these channels.)

During automatic presetting, the memory indicator (M) flashes and the frequency scrolls. The memory indicator and channel numbers are displayed for a second when a station is preset. The last station to be preset is displayed when presetting finishes.

**For Your Reference** - Even if the power supply cord is disconnected from the household AC outlet, the stations remain in memory for approximately two weeks.

### Manual Presetting

Preset the stations one at a time.

1. Tune to the station.
2. Press [MEMORY].
3. Press [TUNE V or  $\wedge$ ] to select a channel.
4. Press [MEMORY].

**For Your Reference** - FM stations can also be preset in the MONO mode.

### Selecting Channels

1. Press [PRESET].  
The channel number flashes for about 5 seconds.
2. Press [TUNE V or  $\wedge$ ].  
Hold down the buttons to change channels faster.

### On the Remote Control

Press [ $\wedge$ , CH, V].

Or

Press the numbered buttons.

For channels 1 to 9, press the corresponding number.

For channels 10 or over, press [ $\geq 10$ , ENTER], then the two digits.

E.g. To select channel 21: [ $\geq 10$ , ENTER]  $\rightarrow$  [2]  $\rightarrow$  [1]

### 4-16.5.9 Other Settings

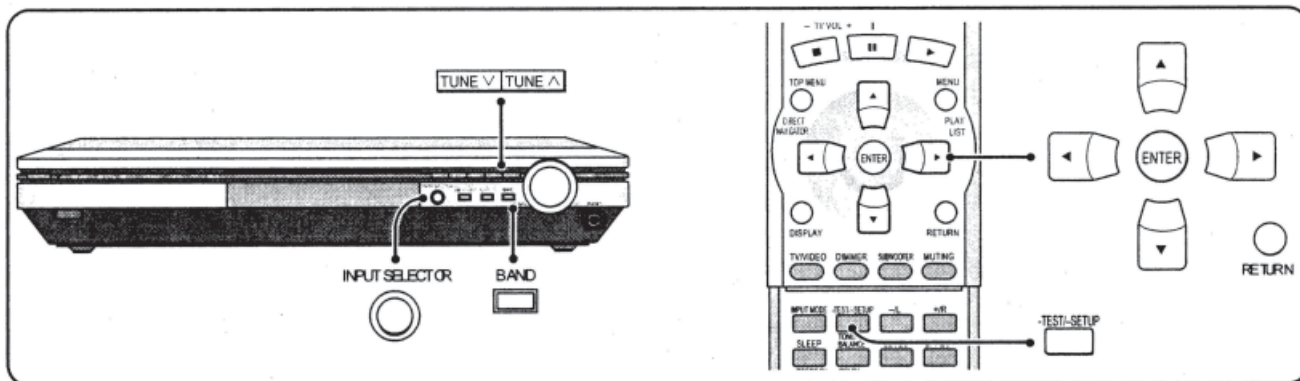

### On the Main Unit

- DR COMP - Dynamic Range Compression**  
Change this setting to listen to software recorded with Dolby Digital at low volume (such as late at night) and maintain audio clarity. It reduces the peak level in loud scenes without affecting the sound field.  
OFF: The software is played with the original dynamic range (factory setting).  
STANDARD: The level recommended by the producer of the software for household viewing.  
MAX: The maximum allowable compression (recommended for night viewing).
- A/D ATT - A/D Attenuator**  
Turn the A/D attenuator on if "OVERFLOW" lights frequently when using 2-channel analog input or DVD 6CH input. The factory setting is OFF.
- SECOND - A - Section Audio Output ( S.A.XR45 )**  
Select the source to output from SECOND AUDIO OUT.  
The factory setting is SOURCE (the source playing on this unit is output).

## CHANGING THE SETTINGS

1. Press [INPUT SELECTOR] and [BAND] at the same time to enter the setting mode.
2. Press [INPUT SELECTOR] to select the item you want to change.
3. Change the settings.
  - A. DR COMP  
Press [TUNE V or Λ] to select “OFF”, “STANDARD” or “MAX”.
  - B. A/D ATT  
Press [TUNE V or Λ] to select “OFF” or “ON”.
  - C. SECOND-A (  )  
Press [TUNE V or Λ] to select “SOURCE”, “CD”, “TV”, “DVD”, “DVD/VCR” or “TAPE”.
    - To listen to the radio, select SOURCE and tune to the station.
4. Press [INPUT SELECTOR] and [BAND] at the same time to exit the setting mode.

### On Screen Display Mode

- A. D-Range Compression - Dynamic Range Compression  
Change this setting to listen to software recorded with Dolby Digital at low volume (such as late at night) and maintain audio clarity. It reduces the peak level in loud scenes without affecting the sound field.  
OFF: The software is played with the original dynamic range (factory setting).  
STANDARD: The level recommended by the producer of the software for household viewing.  
MAX: The maximum allowable compression (recommended for night viewing).
- B. A/D Attenuation  
Turn the A/D attenuator on if “OVERFLOW” lights frequently when using 2-channel analog input or DVD 6CH input. The factory setting is OFF.
- C. Section Audio Output  
Select the source to output from SECOND AUDIO OUT. The factory setting is SOURCE (the source playing on this unit is output).

## CHANGING THE SETTINGS

1. Press and hold [-TEST/-SETUP] to enter the setup menu.
2. Press [▲] or [▼] to select “Other Setups”.
3. Press [ENTER].
4. Press [▲] or [▼] to select the item you want to change.
5. Press [ENTER].
6. Change the settings.
  - A. D-Range Compression  
Press [◀] or [▶] to select “OFF”, “STANDARD” or “MAX”.
  - B. A/D Attenuation  
Press [◀] or [▶] to select “OFF” or “ON”.
  - C. Second Audio Output  
Press [◀] or [▶] to select the “SOURCE”, “CD”, “TV”, “DVD”, “DVD/VCR” or “TAPE”.
    - To listen to the radio, select SOURCE and tune to the station.
7. Press [ENTER].
8. Press [▲] or [▼] to select “Exit from SETUP”.
9. Press [ENTER].

### For Your Reference

- To exit On Screen Display mode  
Press [RETURN] until the setup menu disappears.
- To return to the main menu  
Press [RETURN].

### 4-16.5.10 Other Functions

#### Input Mode

This unit automatically detects whether input is digital or analog, but you can fix the input mode.

Press [INPUT MODE] to select "AUTO", "ANALOG" or "DIGITAL".

#### Balance

You can adjust the balance of the front speakers.

1. Press [TONE/BALANCE] to select "BALANCE".
2. Press [-/L] or [+R] to adjust.

#### Tone

You can adjust the level of the bass and treble.

1. Press [TONE/BALANCE] to select "BASS" or "TREBLE".
2. Press [-/L] or [+R] to adjust bass/treble.

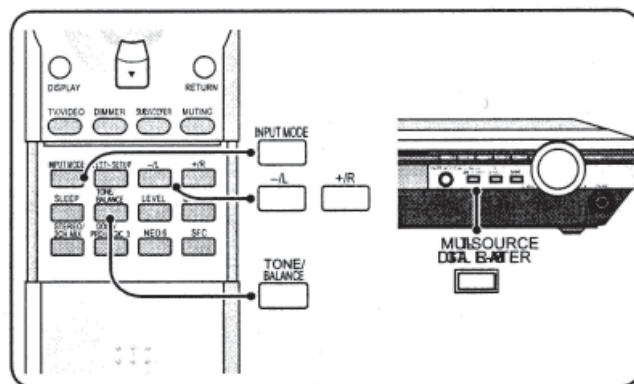

#### For Your Reference

- To adjust the tone  
The STEREO mode must be on and input must be either analog or PCM signals. You cannot adjust the tone if DVD 6CH is selected.

#### Re-Master

This original Panasonic feature boosts the frequencies of the higher harmonics that are lost during recording due to compression.

Press [MULTI-SOURCE DIGITAL RE-MASTER] to select "EFFECT 1", "EFFECT 2", "EFFECT 3" or "EFFECT 4".

When Re-master is on, the current level appears, then each time you press the button:

EFFECT 1: for fast tracks (pop and rock)

EFFECT 2: for tracks with a variety of tempos (jazz)

EFFECT 3: for slow tracks (classical)

EFFECT 4: for compressed audio signals

OFF: the re-master processing is off.

### 4-16.5.11 Making a Recording

#### Recording on Other Equipment

You can record to a tape deck connected to TAPE REC (OUT), a VCR connected to VCR OUT (SA-XR25), a DVD recorder/VCR connected to DVR/VCR OUT (SA-XR45), or digital recording equipment connected to DIGITAL OPTICAL OUT.

See the recording unit's operating instructions for details on how to prepare it for recording.

1. Press [INPUT SELECTOR] to select the source to be recorded.
2. Begin recording  
Follow your recording unit's operating instructions.
3. Start the source to be recorded.  
Follow your equipment's operating instructions.
  - With a tape deck, you can record any analog source except TAPE.
  - With a VCR, you can record any analog source except VCR (SA-XR25).
  - With a DVD recorder/VCR, you can record any analog source except DVR/VCR (SA-XR45).
  - With digital recording equipment, you can record any digital source without copy protection.
  - When you select DVD 6CH INPUT mode, only sound from the front left and right channel is recorded.
  - Some sources do not allow digital recording. Connect through the analog terminals and select "ANALOG" input.

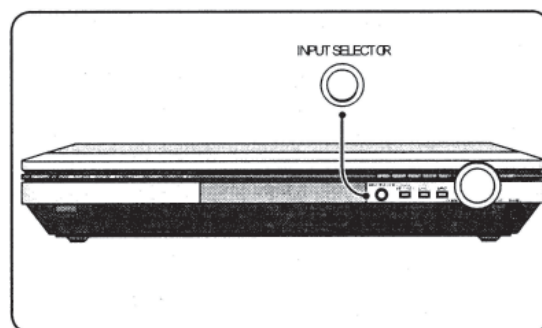

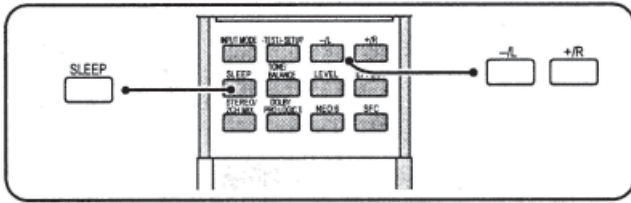

### 4-16.5.12 Sleep Timer

The SLEEP timer can turn the unit off after a set time. It does not control any other components.

1. Press [SLEEP].  
SLEEP → OFF



2. Within 5 seconds  
Press [-/L] or [+R] to select the required time.  
The display change as follows:  
30 ↔ 60 ↔ 90 ↔ 120 (in minutes)

#### To Check the Setting

Press [SLEEP] once.

- The time remaining appears.

#### To Change a Setting

Repeat the procedure from the beginning.

### 4-16.5.13 Troubleshooting Guide

Before requesting service, make the checks in the following chart. If you are in doubt about some of the check points, or if the remedies indicated in the chart do not solve the problem:

In the U.S.A. contact Panasonic Customer Call Center at 1-800-211-7262, or email [consumerproducts@panasonic.com](mailto:consumerproducts@panasonic.com), or web site (<http://www.panasonic.com>).

In Canada, contact Panasonic Canada Inc. Customer Care Centre at 905-624-5505, or web site ([www.panasonic.ca](http://www.panasonic.ca)), or an authorized Service Centre close to you.

**COMMON PROBLEMS**

**No Power**

**No Sound.**

**Sound stops. "F 76", "OVERLOAD" or "FAN LOCK" appears on the display for about a second and then it turns off.**

**"F 70" appears on the display.**



- Ensure the power cord is connected.
- Turn the volume up.
- Check connections to speakers and other equipment.
- Select the correct source.
- Change the D-INPUT (or Digital input) setting to suit the type of connection you have made.
- Check that the digital signals can be decoded by this unit.
- Turn PCM FIX or DTS FIX off.
- Determine and correct the cause, then switch the unit on.

**Causes include:**

- Shorting (bare wires touching) of positive and negative speaker wires.
  - Using speakers with an impedance lower than that rated for this unit.
  - Straining of the speakers through excessive volume or power.
  - Using the unit in a hot environment without proper ventilation.
- Consult your dealer if the problem occurs again after switching the unit on.

- Turn the unit off, disconnect the AC power supply cord, and consult your dealer.

**SOUND MODES**

**Sound is not heard from the center, surround, or subwoofer speakers.**

**Surround is not heard from the surround back speaker.**

**Cannot use Dolby Pro Logic II, NEO:6 or SFC**



- Ensure the SPEAKERS (or Speaker Size) settings for your speakers are correct.
- Turn 2CH MIX off.
- The source may be stereo. Change the sound mode.
- Ensure the SPEAKERS (or Speaker Size) settings for your speakers are correct.
- Turn ENHANCED SURROUND on.
- Turn DVD 6CH INPUT off.
- You cannot use Dolby Pro Logic II, NEO:6 or SFC when input is PCM with sampling frequencies of 192, 176.4 (SA-XR45, OPTICAL2), 96, OR 88.2 kHz.

**RADIO**

**The radio cannot be tuned in or there is a lot of noise and interference.**

**The radio cannot be tuned in or there is a lot of noise and interference.**



- Connect the appropriate antenna. (You may need an outdoor antenna or one with more elements.)
- Adjust the position of the FM or AM antenna.
- Reduce the treble.
- Turn off nearby televisions, video decks, DVD players, and satellite receivers.
- Separate the antenna from other cables, cords, and appliances.
- Try changing the A/D ATT (or A/D attenuation) setting. This may change the volume, but noise will also reduce.

### 4-16.5.14 The Reset Function

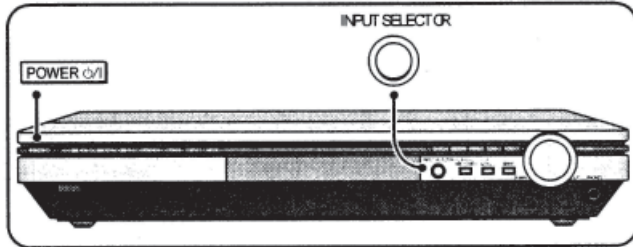

#### **While the unit is on**

While pressing and holding [INPUT SELECTOR] press [POWER ].  
 “RESET” appears on the display.

The operation settings for the unit will be initialized to the settings made at the time of shipment. However, any preset radio stations will not be erased.

### 4-16.5.15 Maintenance

#### **IF THE SURFACES ARE DIRTY**

To clean this unit, wipe with a soft, dry cloth.

- Never use alcohol, paint thinner or benzene to clean this unit.
- Before using chemically heated cloth, read the instructions that came with the cloth carefully.

## 4-16.6 DirectTV Digital Satellite Receiver

The 450 LXi has a Direct TV Digital Satellite Receiver installed in the front area of the coach. An additional rear unit may be purchased as an option. Basic operating and maintenance instructions are as follows:

### 4-16.6.1 Important Safety Instructions

For your safety and protection, read all instructions completely before you attempt to install or use your satellite system. In particular, read this safety section carefully. Keep this safety information where you can refer to it if necessary.

**Heed Cautions** - All cautions on the product and in the operating instructions should be adhered to.

**Follow Instructions** - All operating and use instructions should be followed.

### THESE CAUTIONS AND SYMBOLS APPEAR ON THE BACK OF THE RECEIVER

#### **WARNING or CAUTION**

Double insulated systems are protected by additional board clearances and creepage, so that the unit will not be a safety hazard to the end-user.

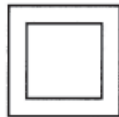

## IMPORTANT SAFETY INSTRUCTIONS

1. Read these instructions.
2. Keep these instructions handy.
3. Heed all warnings.
4. Follow all instructions.
5. Do not use this apparatus near water.
6. Clean only with dry cloth.
7. Do not block any ventilation openings. Install in accordance with the manufacturer's instructions.
8. Do not install near any heat sources such as radiators, heat registers, stoves, or other apparatus (including amplifiers) that produce heat.
9. Do not defeat the safety purpose of the polarized or grounding-type plug. A polarized plug has two blades with one wider than the other. A grounding type plug has two blades and a third grounding prong. The wide blade or the third prong is provided for your safety. If the provided plug does not fit into your outlet, consult an electrician for replacement of the obsolete outlet.
10. Protect the power cord from being walked on or pinched particularly at plugs, convenience receptacles, and the point where they exit from the apparatus.
11. Only use attachments/accessories specified by the manufacturer.
12. Use only with the cart, stand, tripod, bracket, or table specified by the manufacturer or sold with the apparatus. When a cart is used, use caution when moving the cart/apparatus combination to avoid injury from tip-over.
13. Unplug this apparatus during lightning storms or when unused for long periods of time.
14. Refer all servicing to qualified service personnel. Servicing is required when the apparatus has been damaged in any way, such as power-supply cord or plug is damaged, liquid has been spilled or objects have fallen into the apparatus, the apparatus has been exposed to rain or moisture, does not operate normally, or has been dropped.

### 4-16.6.2 Installation

**Polarization** - This DIRECT TV Receiver is equipped with a plug that will fit into the power outlet only one way. Do not modify the plug defeating this feature. If the plug does not fit, contact your electrician to replace your outlet. To prevent electric shock, do not use this plug with an extension cord or outlet unless you can fully insert the blades without blade exposure.

**Power Sources** - Operate this DIRECT TV Receiver only from the type of power source indicated on the marking label. If you are not sure of the type of power supply, consult your dealer or local power company.

**Power-Cord Protection** - Protect the power cord from being walked on or pinched particularly at plugs, convenience receptacles, and the point where they exit from the apparatus.

**Overloading** - Do not overload wall outlets, extension cords, or integral convenience receptacles as this can result in a risk of fire or electrical shock.

**Ventilation** - Slots and openings in the cabinet are provided for ventilation to ensure reliable operation of the product and to protect it from overheating. Do not block any ventilation openings. Install in accordance with the manufacturer's instructions.

The openings should never be blocked by placing the product on a bed, sofa, rug, or similar surface. This product should not be placed in a built-in installation such as a bookcase or rack unless proper ventilation is provided and the manufacturer's instructions have been adhered to.

For electrical safety, power line operated equipment or accessories connected to this unit should bear the UL listing mark and should not be modified so as to defeat the safety features. This will help avoid any potential hazard from electrical shock or fire. If in doubt, contact qualified service personnel.

**Heat** - Do not install near any heat sources such as radiators, heat registers, stoves, or other apparatus (including amplifiers) that produce heat.

**Accessories** - To avoid personal injury or damage to the DIRECT TV Receiver, do not place the DIRECT TV Receiver on any unstable cart, stand, table, or bracket. Any mounting of the product should follow the manufacturer's instructions.

**Attachments** - Do not use attachments unless recommended by DIRECT TV as they may cause hazards.



**Satellite Dish Antenna Grounding** - The outdoor satellite dish antenna used to receive satellite signals and the cable used to connect the satellite dish antenna to the indoor receiving unit are required to comply with local installation codes and the appropriate sections of the National Electric Code (NEC) and in particular Article 810-15, which covers proper installation and grounding of television receiving equipment, as well as to Article 820-33, which specifies that the satellite dish antenna cable ground shall be connected to the grounding system of the building as close to the point of cable entry as practical. These codes require proper grounding of the metal structure of the outdoor satellite dish antenna and grounding of the connecting cable at a point where it enters the house (or other building). If you are having a professional installer perform the installation, the installer must observe installation codes. This manual contains instructions on how to make the installation in compliance with the NEC. If additional local installation codes apply, contact local inspection authorities.

Examples of Antenna Grounding according to the National Electrical Code instructions contained in "Radio and Television Equipment".

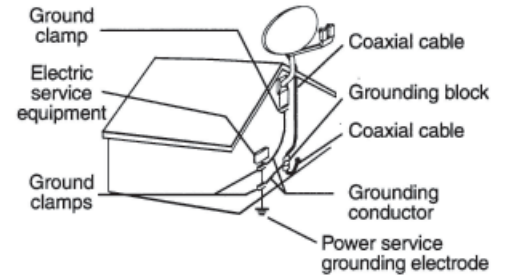

**NOTE:** The DIRECT TV Receiver shall be grounded through the satellite/local antenna cable before plugging into the telephone jack, and it must remain grounded thereafter.

**Water and Moisture - WARNING!** To reduce the risk of fire or electric shock, do not expose this product to rain or moisture.

**Lightning** - For added protection for this product during a lightning storm, or when it is left unattended and unused for long periods of time, unplug it from the wall outlet, disconnect the antenna and cable system, and disconnect it from the telephone line. This will prevent damage to the product due to lightning and power-line surges.

**Television Antenna Information** - Installing an outdoor antenna can be hazardous and should be left to a professional antenna installer. Do not locate the outside antenna system in the vicinity of overhead power lines or other electric light or power circuits, or where it can fall into such power lines or circuits. When installing an outside antenna system, take extreme care to keep from touching such power lines or circuits, as contact with them might be fatal. If an outside antenna is connected to the DIRECT TV Receiver, be sure the antenna system is grounded so as to provide some protection against voltage surges and built-up static charges. This DIRECT TV Receiver is equipped with a plug that will fit into the power outlet only one way. Do not modify the plug defeating this feature. If the plug does not fit, contact your electrician to replace your outlet. To prevent electric shock, do not use this plug with an extension cord or outlet unless you can fully insert the blades without blade exposure. Section 810 of the NEC, NFPA No. 70 1987, provides information with respect to proper grounding of the mast and supporting structure, grounding of the lead-in wire to an antenna discharge unit, size of the grounding conductors, location of antenna discharge unit, connection to grounding electrodes, and requirements for the grounding electrode.

**Power Lines** - Extreme care must be taken when installing and adjusting or maintaining the outdoor antenna and connecting cable, especially in the vicinity of overhead power lines, electric lights, or power circuits. When installing the outdoor antenna or cable, extreme care should be taken to keep from touching or approaching such power lines or circuits, as contact with them might be fatal.

**Cleaning** - Unplug this receiver from the wall outlet before cleaning. Do not use liquid or aerosol cleaners. Use only a damp cloth for cleaning.

**Object and Liquid Entry** - Never push objects of any kind into this DIRECT TV Receiver through openings as they may touch dangerous voltages or "short out" parts that could result in a fire or electric shock. Never spill liquid of any kind on the receiver. No objects filled with liquids, such as vases, shall be placed on the apparatus.

### 4-16.6.3 Service

**Servicing** - Do not attempt to service this unit yourself as opening or removing covers may expose you to dangerous voltage or other hazards. There are no user serviceable parts inside. Refer all servicing to qualified service personnel.

**Conditions Requiring Service** - Unplug the DIRECT TV Receiver from the wall outlet and refer servicing to qualified personnel under the following conditions.

- When the power supply cord or plug has been damaged.
- If liquid has been spilled on, or objects have fallen into, the DIRECT TV Receiver or it has been exposed to water.
- If the DIRECT TV Receiver does not operate normally by following the operating instructions. Adjust only those controls that are covered by the operating instructions. Other adjustments may result in damage and will often require extensive work by a qualified technician to restore the DIRECT TV Receiver to its normal operation.
- If the DIRECT TV Receiver has been dropped or the cabinet has been damaged.
- When the DIRECT TV Receiver exhibits a distinct change in performance.

**Replacement Parts** - When replacement parts are required, have the technician verify that the replacements being used have the same safety characteristics as the original parts.

Use of replacement parts specified by the manufacturer can prevent fire, electric shock, or other hazards.

**Safety Check** - Upon completion of any service or repairs to this DIRECT TV Receiver, ask the service technician to perform safety checks recommended by the manufacturer to determine that the 1 DIRECT TV Receiver is in safe operating condition.

Multi-satellite capable if used with a DIRECT TV Multi-Satellite Dish Antenna, not included.

Your DIRECT TV Receiver is able to receive upgrades or modifications to some of its features and functions. These modifications will occur automatically, usually at times when the receiver would likely be turned off. If your receiver is on when an upgrade or modification is sent, you may experience a disruption in reception for a minute or two. Your reception should return to normal after the modification is complete. Your receiver must be plugged in to receive any upgrades. Do not unplug your receiver while an upgrade is in progress. Please consult the Upgrade menu to find a schedule of upgrades or modifications planned by DIRECT TV.

With this receiver (GAEBOA, GCEBOA) and the proper satellite dish antenna, you may be able to subscribe to local channels from DIRECT TV in certain areas. Additional equipment may be required in some markets. Check with your retailer or visit DIRECTTV.com for information on availability of local channels from DIRECTTV in your area.

### 4-16.6.4 Setup Overview

*At this point, you should have:*

- Mounted the DIRECT TV satellite antenna and pointed it in the general direction of the satellite.
- Grounded the antenna as described in your antenna installation instructions.
- Attached RG-6 coaxial cable(s) to the antenna LNB connector(s).
- Routed the other end of the antenna cable to the back of your DIRECT TV Receiver.
- Place the DIRECT TV Receiver accessible to a telephone modular jack.

Ensure that you have completed these procedures, then continue to the next page to begin installing the DIRECT TV Receiver.



**NOTE:** In most cases, the Direct TV System will be installed when you take delivery of the coach. These instructions and the instructions following are only in case something happens and the receiver and satellite need to be re-installed at some point in time.

### 4-16.6.5 Attach the Antenna Cable

You can configure your system several ways, depending on what additional components (such as a VCR, DVD player, or A/V receiver) you select. For now, however, use the simplest configuration to check your antenna and cabling.

- Ensure that the DIRECT TV® Receiver is not plugged into an electrical outlet.
- Attach the RG-6 coaxial antenna cable to the SATELLITE IN connector on the back of the DIRECT TV Receiver. Refer to the appropriate figure below and on the next page.

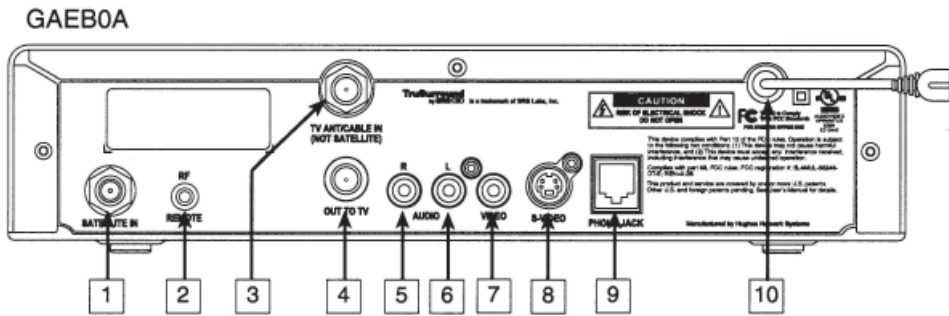

Rear panel connections - DIRECT TV Receiver model GAEB0A

1	SATELLITE IN connector	6	AUDIO OUTPUT (L) jack
2	RF REMOTE antenna jack	7	VIDEO OUTPUT jack
3	TV ANTENNA/CABLE IN connector	8	S-VIDEO jack
4	OUT TO TV connector	9	TELEPHONE JACK
5	AUDIO OUTPUT (R) jack	10	AC POWER CORD

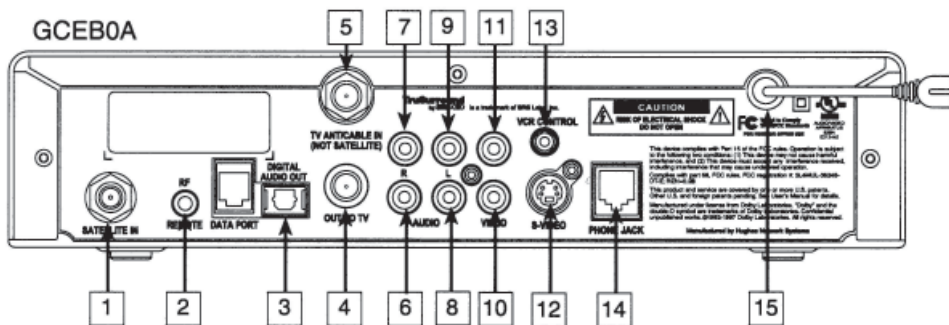

Rear panel connections - DIRECT TV Receiver model GCEB0A

### 4-16.6.6 Connect Your TV

Depending on your TV, you can connect it to the receiver in one of three ways:

- S-Video cable (best picture quality) or
- Video cable (very good picture quality) or
- Coaxial cable (good picture quality)

In addition to your video connection, use a set of audio cables (L/R) to provide stereo sound. If your TV does not have audio jacks, you will hear monophonic audio. This is acceptable for the procedures described in the next section.

**To connect your TV to the DIRECT TV® Receiver:**

1. Select the appropriate connection:

*If your TV has an S-Video jack -*

- Use an S-Video cable (not supplied) to connect the DIRECT TV Receiver’s S-VIDEO jack to the TV’s S-VIDEO jack.
- Use audio cables to connect the DIRECT TV Receiver ‘s AUDIO jacks to the TV’s AUDIO IN jacks.

*If your TV has RCA-type A/V connectors -*

- Connect the DIRECT TV Receiver’s AUDIO and VIDEO jacks to the TV’s A/V IN jacks.
- If your TV has only one AUDIO IN jack, connect the receiver’s AUDIO L jack to the TV AUDIO IN jack.

*If your TV only has an RF (coaxial) connector*

<b>1</b>	<b>SATELLITE IN connector</b>	<b>9</b>	<b>AUDIO OUTPUT (L) jack</b>
<b>2</b>	<b>RF REMOTE antenna jack</b>	<b>10</b>	<b>VIDEO OUTPUT jack</b>
<b>3</b>	<b>DIGITAL AUDIO OUTPUT optical jack</b>	<b>11</b>	<b>VIDEO OUTPUT jack</b>
<b>4</b>	<b>OUT TO TV connector</b>	<b>12</b>	<b>S-VIDEO jack</b>
<b>5</b>	<b>TV ANTENNA/CABLE IN connector</b>	<b>13</b>	<b>VCR CONTROL cable jack</b>
<b>6</b>	<b>AUDIO OUTPUT (R) jack</b>	<b>14</b>	<b>TELEPHONE JACK</b>
<b>7</b>	<b>AUDIO OUTPUT (R) jack</b>	<b>15</b>	<b>AC POWER CORD</b>
<b>8</b>	<b>AUDIO OUTPUT (L) jack</b>		

*TV only coaxial*

- Connect the DIRECT TV Receiver’s OUT TO TV connector to the TV’s VHF/UHF IN or RF IN jack.
- 2. Connect one end of the telephone line cord provided into the DIRECT TV Receiver’s PHONE JACK.
- 3. Connect the other end into a modular telephone outlet.
- 4. Plug the TV into an electrical outlet.
- 5. Plug the DIRECT TV Receiver power cord into an electrical outlet. If the front panel Power indicator does not illuminate, press the POWER button.

**Onscreen Menu Icons**

These icons appear in on screen menus and are used throughout this manual:



**Toggle or Step** - Press SELECT to toggle (switch) a setting from “ON” to “OFF” or step through the available choices each time you press SELECT.



**List of Options** - Menu button will display a list of choices in a pop-up menu when you press SELECT.



**Series of Boxes** - Multiple screen will appear in a series requesting you to enter numbers and/or letters for the particular feature when you press SELECT.

### 4-16.6.7 Determine Antenna Angles

This section explains how to determine the proper antenna position. Expressed in degrees of azimuth (horizontal) and elevation (vertical). Use the receiver front panel controls shown below to complete this procedure.

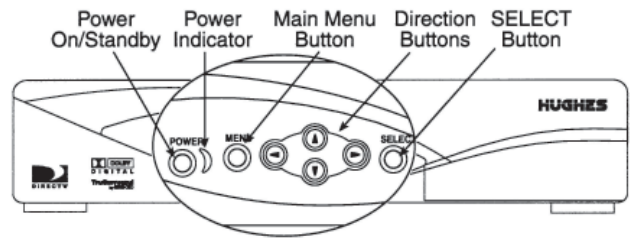

1. Press the front panel MENU button to display the MAIN MENU below.
2. Use the ▼ button to highlight the System Setup tab.

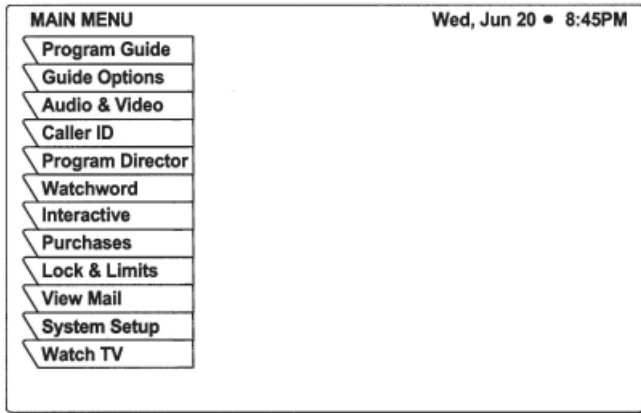

Main Menu tabs

Tilt angle also appears if you have selected an Oval Antenna from the Dish Type menu.

3. Press the front panel SELECT button.
4. The INSTALL menu allows you to determine the correct antenna position using your 5-digit ZIP code. Enter your ZIP code and press SELECT.  
The correct azimuth and elevation angles appear as shown below.
5. Use these values to properly align your dish antenna.

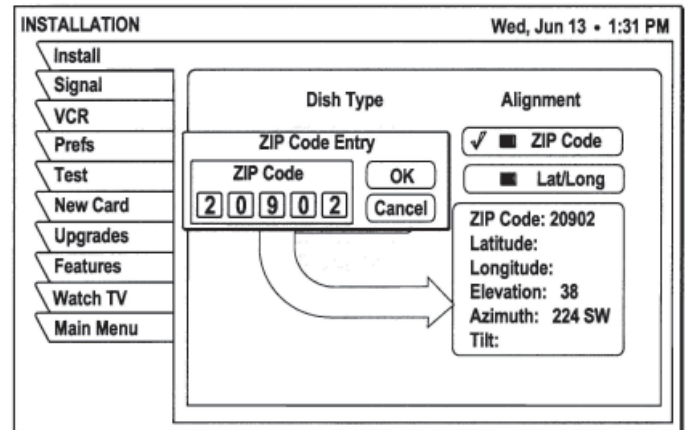

Finding antenna settings based on ZIP code

### 4-16.6.8 Testing Your System

When you have aligned your dish antenna to the azimuth and elevation angles shown on the install pane:

1. Highlight the Signal tab.
2. Use the ► button to highlight the Source pull-down menu
3. Signal quality is indicated by a scale at the bottom of the pane and with an audible indication. The frequency and tempo of the tone increase with signal strength.

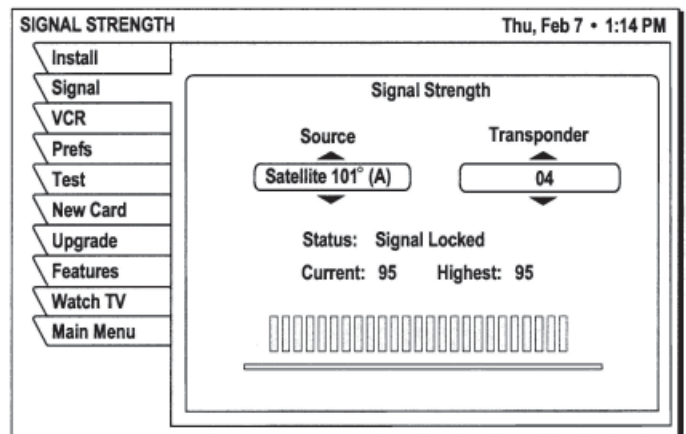

4. Highlight the Transponder pull-down menu.
5. You may need to select another transponder to achieve the highest signal indication.
6. Select the transponder providing the best signal.
7. Use the ▼ button to highlight the Test tab.
8. Highlight Begin Test and press the SELECT button.

Results appear within a few seconds and should resemble those in the figure. If your test results are much different from those shown in the figures, or you receive no signal indication, refer to *Installation pane* found a little later in this section.

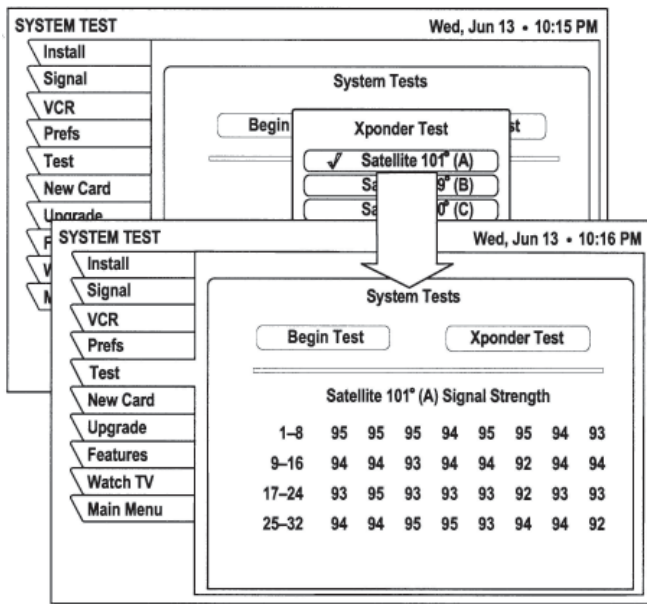
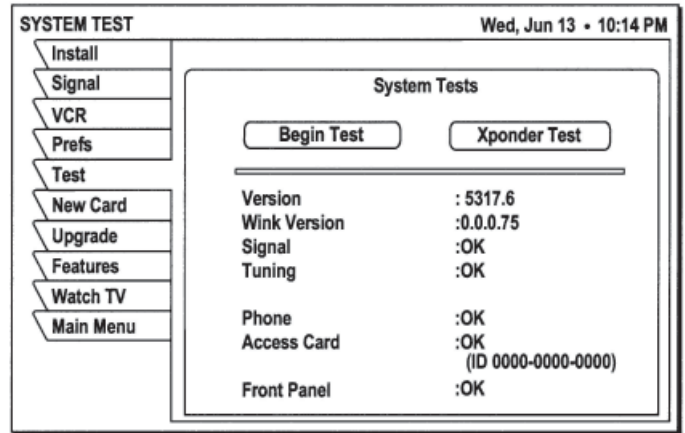

To perform the Transponder test:

1. Move the highlight to the *Xponder Test* pull-down menu.
2. Press the SELECT button.
3. Press SELECT again to test the first selection on the pop-up menu.

Your results will differ slightly from those shown, depending on your geographic location and specific installation. However, if your results are very different from these examples (i.e., rows of zeros or single-digit numbers):

- Highlight the install tab on the INSTALLATION menu. Verify your settings.
- Re-enter your ZIP code if necessary to verify you have used the correct antenna pointing parameters for your location.
- Check your cable connections.
- Ensure the DIRECT TV® Receiver is connected to a module telephone jack.

Once you have successfully obtained a signal and your test results resemble those shown in the figures, call DIRECT TV (or your subscription service provider) to activate service if you have not done so already.

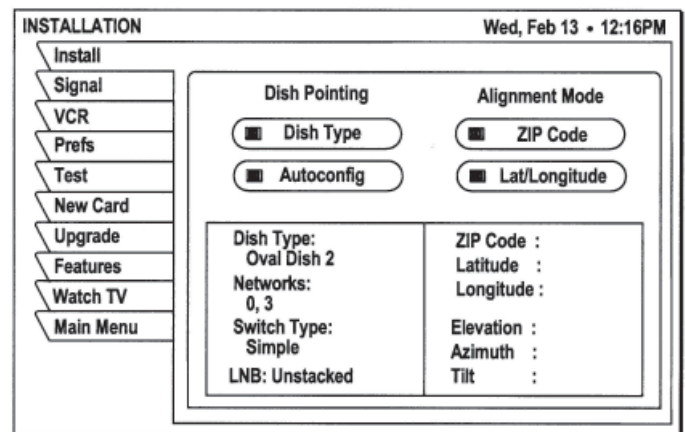

Installation pane

### 4-16.6.9 Adding System Components

You can configure your DIRECT TV Receiver several ways depending on the additional audio/video components you want to use.

*This section explains how to:*

- Connect a terrestrial (broadcast) TV antenna.
- Connect the optional RF remote control antenna.
- Connect and set-up a VCR.
- Integrate the DIRECT TV Receiver into your existing audio or A/V system.

### 4-16.6.10 Connecting Components

*At this point, you should have:*

- Verified that your system is operating properly.
- Connected your DIRECT TV Receiver to your TV.
- Unplugged all components from electrical outlets.

#### Connecting a Terrestrial Antenna

You can connect a terrestrial (broadcast) TV antenna to your DIRECT TV Receiver by connecting it to the DIRECT TV Receiver's TV ANT/CABLE IN jack (refer to the figures in [Attach the Antenna Cable](#) section found earlier in manual). The remote control INPUT button allows you to switch between DIRECT TV programming and input from the terrestrial antenna.

#### Connecting a Terrestrial Antenna

You can connect a terrestrial (broadcast) TV antenna to your DIRECT TV Receiver by connecting it to the DIRECT TV Receiver's TV ANT/CABLE IN jack. The remote control INPUT button allows you to switch between DIRECT TV programming and input from the terrestrial antenna.

#### Connecting the RF Remote Control Antenna

The DIRECT TV Receiver uses an optional RF (radio frequency) remote control antenna that allows you to control your receiver from other rooms in your house.

1. Slide the antenna into the base as shown. No tools are required.
2. Plug the RF remote control cable into the RF REMOTE connector on the DIRECT TV Receiver rear panel.
3. Extend the cable and place the antenna in the desired location.

To achieve the best operating range from the remote control, position the antenna as high and as far away from metal objects as possible.

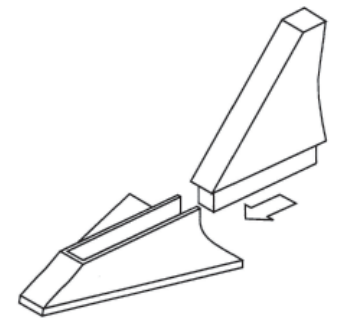

Assembling the optional RF antenna

### 4-16.6.11 Connecting a VCR

Follow these instructions to connect your TV and VCR to the DIRECT TV Receiver. Connect the satellite antenna RG-6 coaxial cable to the DIRECT TV Receiver's SATELLITE IN jack.

1. Depending on your VCR, select the appropriate connection to the DIRECT TV Receiver:
  - If your VCR has A/V connectors -*
    - Connect the DIRECT TV Receiver's AUDIO and VIDEO jacks to the VCR's A/V IN jacks.
  - If your VCR only has an RF (coaxial) connector -*
    - Connect the DIRECT TV Receiver's OUT TO TV connector to the VCR's VHF/UHF IN or RF IN jack.
    - If your VCR has only one AUDIO IN jack, connect the receiver's lower (mono) AUDIO L jack to the VCR's AUDIO IN jack.
2. Depending on your TV and VCR, select the appropriate method to connect the VCR to the TV:
  - If your TV and VCR have A/V connector -*
    - Connect the DIRECT TV Receiver's AUDIO and VIDEO jacks to the TV's A/V IN jacks.
  - If your TV or VCR only has an RF (coaxial) jack -*
    - Connect the VCR's VHF/UHF OUT jack to the TV's VHF/UHF IN jack.
3. Plug the TV, VCR, and DIRECT TV Receiver power cords into an electrical outlet.

**Connect the VCR Control Cable** - (Model GCEBOA only) the DIRECT TV Receiver can control your VCR for unattended recording, using the VCR Control Cable provided

1. Plug the VCR control cable into the rear panel VCR CONTROL jack.
2. Temporarily position the other end over the VCR's remote control sensor (normally a small dark plastic window on the VCR front panel).

The remote control sensor may be labeled or identified in your VCR manual. If it is not identified, scan the front of the VCR with your VCR remote control:

3. Hold the VCR remote control about ½-inch (1.3 cm) from the front left side.
4. Slowly move the remote control to the right as shown in the figure.
5. Repeatedly press the remote control's power key on and off.

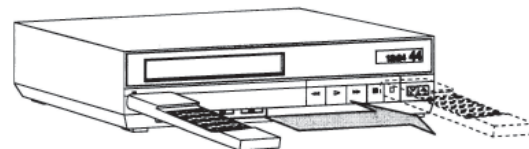

Scanning for the VCR remote control sensor

6. When your VCR responds to your pressing the remote control power, note the position. Temporarily tape the emitter to the position you marked until you verify that it works properly.

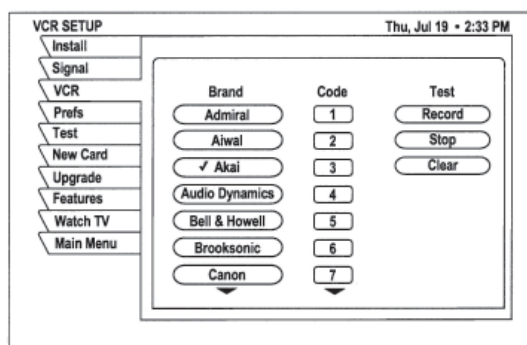

VCR SETUP menu pane

7. Test the VCR control feature as described below.
8. Remove the temporary mounting tape. Attach the emitter permanently with peel-and-stick backing. This will not interfere with normal VCR operation. The VCR SETUP menu provides the settings to allow the DIRECT TV® Receiver to communicate with your VCR.
9. Scroll through the VCR brands using the joystick ▲ and ▼ buttons. If you cannot find the correct code listed for your VCR brand, try related brands that use the same code. Also, your VCR may respond to multiple codes.
10. Use the remote control SELECT button to try each code.
11. Alternate between this procedure and testing the code.

**Test the VCR (Record/Stop)** - This Record/Stop test verifies the specified brand and code that controls your VCR. Before starting the test:

- Turn the VCR power on.
- Verify the VCR Control Cable is properly connected.
- Insert a recordable videotape into the VCR.

Use the DIRECT TV Receiver front panel controls, rather than the remote control, to test the codes.

Test the VCR record and stop commands. If either command does not function, try other codes shown for your VCR brand. If you are unsuccessful after trying all available codes, recheck your VCR Control Cable connections and IR emitter placement.



**NOTE:** Signals coming from the remote control at the same time as signals coming from the VCR Control cable may provide unreliable test results.



### 4-16.6.12 Connecting a Home Entertainment System

You can integrate the DIRECT TV® Receiver into your entertainment system to take advantage of enhanced audio and video capability. Follow these instructions to connect your DIRECT TV Receiver.



**NOTE:** The A/V receiver must be turned on in order to send the video signal to your TV.

- To connect the DIRECT TV Receiver to your audio system, use A/V cables to connect the satellite receiver to the audio receiver's AUDIO IN jacks.
  - Dolby Digital - With the GCEBOA model, you can enjoy programs that contain a Dolby Digital sound track. We recommend that you listen in surround sound for maximum enjoyment of these programs. You can connect the stereo outputs of the GCEBOA to a receiver that contains a Dolby Surround Pro Logic decoder. This will provide you with three audio channels in the front and a mono surround channel.
  - To take full advantage of Dolby Digital programming, connect the GCEBOA digital audio output to an external 5.1-channel Dolby Digital decoder or receiver. This provides you with three front channels, two independent surround channels, and a sub-woofer channel.
1. Connect the satellite antenna RG-6 coaxial cable to the DIRECT TV Receiver's SATELLITE IN jack.
  2. Connect the DIRECT TV Receiver's A/V jacks to the VCR and A/V receiver's A/V jacks.
  3. AUX, optical connection, and digital output connections - If your audio receiver has coaxial or optical digital connectors, connect the appropriate type of cable to the DIRECT TV Receiver's DIGITAL AUDIO OUT for two-channel digital stereo. If your A/V receiver is also capable of decoding Dolby Digital, use this connection in order to listen in full 5.1-channel surround sound. Additional audio information begins on Adjusting Audio and Video section found later in manual.
  4. Connect the VCR's A/V OUT jacks to a pair of the A/V receiver's A/V IN jacks.
  5. Connect the A/V receiver's MONITOR OUT jack to the TV's VIDEO IN jack.
  6. Plug the components into an electrical outlet.



**NOTE:** If you have connected a VCR to your entertainment system in a way that routes the satellite receiver's signal to your VCR before it reaches the TV, you may see a distorted picture if you try to record a copy-protected program. A Can't Tape symbol in the screen banner identifies these programs. If this occurs, simply stop recording and the picture will automatically correct itself.

### 4-16.6.13 Using the Remote Control

This section explains how to:

- Use the HMRC-8 and HMRC-9 remote control functions.
- Install and replace the remote control batteries.
- Program the remote to work with your system components.
- Access interactive programming features.

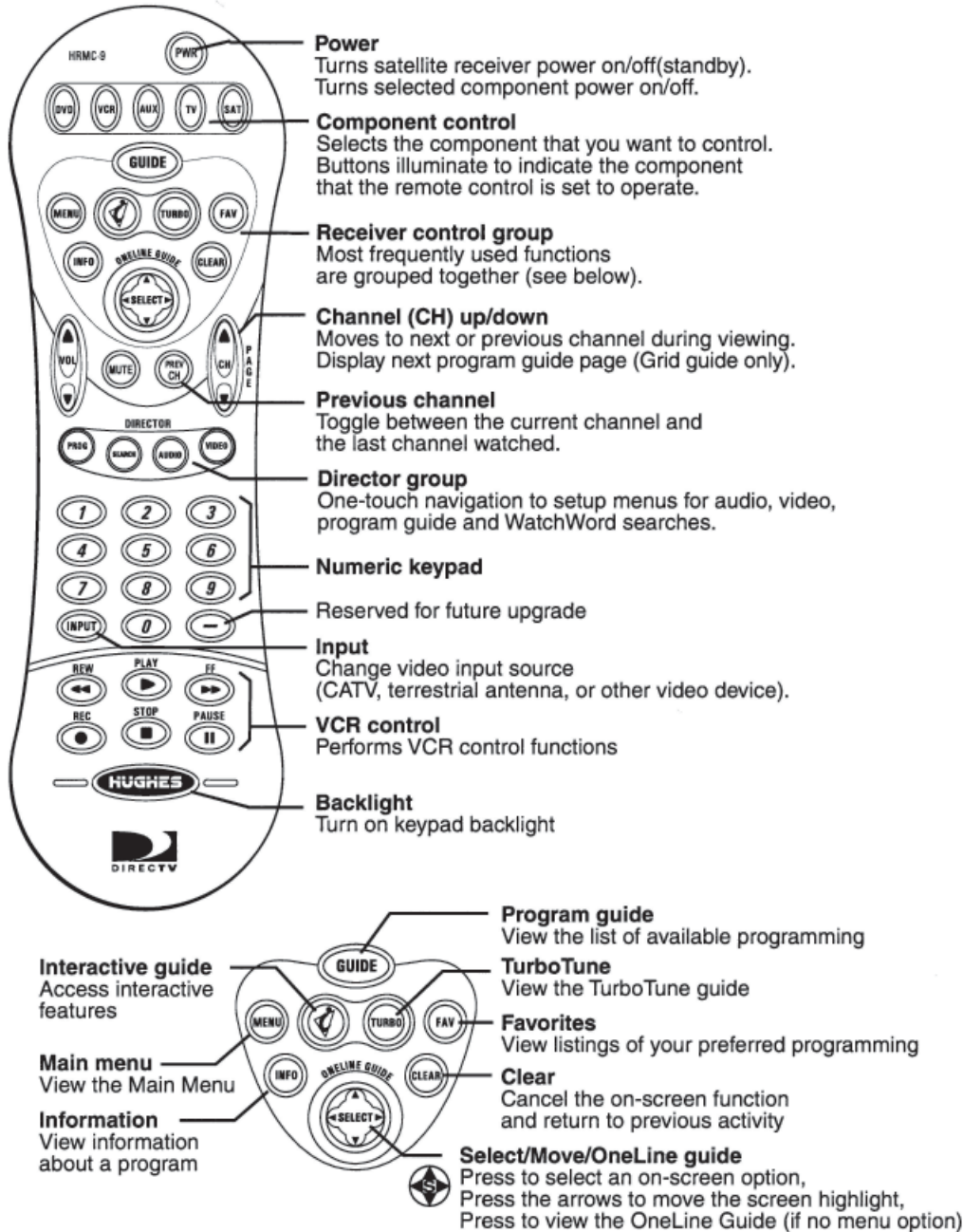

HMRC-9 Remote Control Function Quick Reference

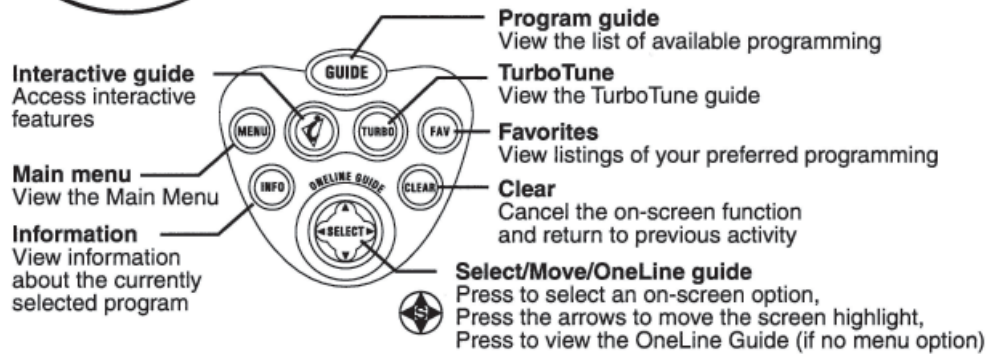
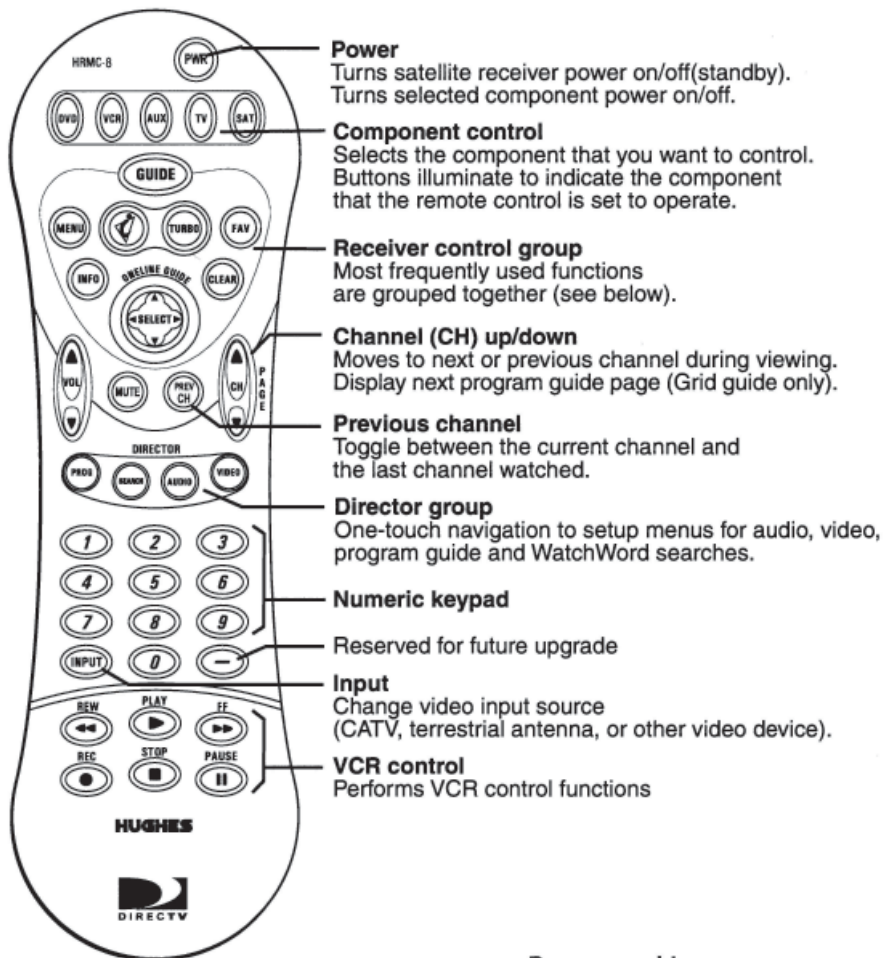

HMRC-8 Remote Control Function Quick Reference

The DIRECT TV® Receiver front panel buttons can provide the basic controls needed to access major DIRECT TV System features. However, using the remote control simplifies accessing the basic system functions, enhances your system’s capabilities, and provides convenient shortcuts to extended features. Additionally, most remote control buttons can also control other home entertainment system components.

### 4-16.6.14 Remote Control Functions

The joystick is the most versatile (and most used) remote control feature. Using only the joystick, you can perform virtually all on-screen functions including:



- Selecting a highlighted screen menu item.
- Moving the screen highlight (or cursor) up, down, left and right.
- Jumping directly to the OneLine™ Guide.
- Changing channels using the OneLine Guide.

Use the joystick to move up, down, left, or right through the on-screen displays. This  icon appears throughout this manual to instruct you to use the joystick to navigate through on-screen menus and guides. SELECT means press the joystick in the center to activate or choose a highlighted menu option.

Press the joystick up or down to display the OneLine guide while you are watching a program. When the OneLine guide appears, press the joystick up or down to step to the next higher- or lower-numbered channel.

Press the GUIDE button to display the current program guide. Press it a second time (while a program title is highlighted) to display the Guide Options menu.



Press the INFO button to display a brief description about the program you are viewing. For more details, press it again to display the Information Banner. The INFO button provides scheduling information (and pay per view purchase information) about the program highlighted in the program guide. See [Using Program Guides](#) section for more information.



Use the CHANNEL (CH) button to move up or down to the next available channel in the OneLine Guide or scroll through a page of program guide selection.



Press the CLEAR button to exit from any on-screen guide, remove banners, or terminate an action.



The INPUT button allows you to select programming from additional program sources connected to the satellite receiver such as a DVD player, VCRs, or a terrestrial TV antenna signal. Repeatedly press INPUT to cycle through each available input source in your system.



Press the SAT component select button to control the DIRECT TV™® Receiver. The other component select buttons indicate the devices they control. You can program the AUX button to control another digital device such as an audio CD player.



The DIRECTOR buttons provide convenient shortcuts to find programming and adjust system features to suite your personal preferences.

**Installing Remote Control Batteries** - To install or replace the remote control batteries:

1. Locate the battery compartment on the back of the remote control.
2. Remove the battery compartment cover.
3. Insert two “AAA” size batteries as shown, observing the correct polarity.
4. Replace the battery compartment cover.

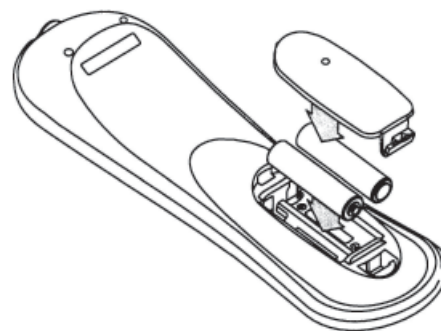

Installing batteries in the remote control

### 4-16.6.15 Programming the Remote Control

You can operate your TV, VCR, and Audio/Video receiver using your HRMC-8 or HMRC-9 remote control. Use the Code Scanning or Code Entry method to program the remote control. Code scanning may be more time-consuming, but you don't need to know manufacturer's control codes. Using the Code entry method may be quicker, but you'll need to know the correct manufacturer's control codes for each component you want to operate.

1. Aim your remote control at the component you want to use.
2. Hold down the desired device button (TV, for example).
3. Press the MUTE button for one second.
4. Release both buttons together.
5. The device button (in this example, the TV button) glows and remains lit. If the button does not light, repeat the previous steps.
6. Use one of the two programming methods described above.



**Code Scanning** - To use this method:

1. Repeatedly tap the top part of the CHANNEL (CH) button.
2. Continue to step through the codes until the component turns off, indicating you have found the correct component code. If you accidentally pass a code that responds or realize you may not have been aiming the remote control at the component, tap the lower part of the CHANNEL (CH) button to step backward through the codes.
3. Press the remote control POWER button to verify the proper code by turning the device on and off.
4. Press the device button (in this example, TV) again to lock in the code.



**Code Entry** - To use this method:

1. Find the three-digit code or codes for the type and brand of the component you want to control (in this example, TV). Refer to [Appendix B - Manufacturers Device Control Codes](#) for assistance.
2. If several codes are listed, you may have to try some or all of them. After entering a code, press the remote control's POWER button to test it. The correct code turns the device on and off.
3. Press the device (DVD, VCR, AUX, TV, SAT) button again to lock the code.

### 4-16.6.16 Using DIRECT TV INTERACTIVE™ powered by Wink Communications®

DIRECT TV INTERACTIVE™ powered by Wink Communications® is a free, easy-to-use service that allows you to interact with the television shows and advertisements. When the blinking  symbol appears in the upper left part of your screen, you know that the program you're watching has been enhanced with DIRECT TV INTERACTIVE.



Simply press  button on your remote control. You can use your remote control to access up-to-the-minute sports scores, news and weather, get program trivia, respond to offers during commercials, and purchase products, all while watching TV.

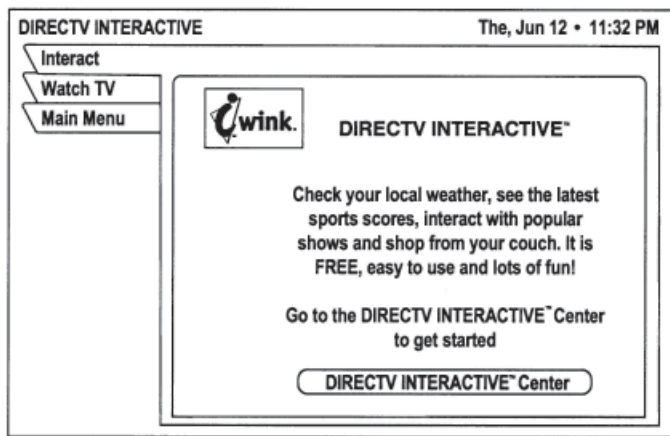

Select the DIRECT TV INTERACTIVE Center menu bar, then follow the simple directions provided on the subsequent screens.

### 4-16-6.17 Using the Menus

The section covers:

- How to find the menus you need to perform common tasks.
- Using the Program Director.
- How to purchase pay per view events.
- How to set and modify preferences.

The table below lists the MAIN MENU tabs, their submenus, and what they do.

**Menu function overview**

Main Menu Tab	Screens (see section)	If you want to:
<b>Program Guide</b>	<i>Program Guide</i>	<ul style="list-style-type: none"> <li>• View and modify the program guide.</li> </ul>
<b>Guide Options</b>	<i>Theme</i> <i>Times</i> <i>Favorites List</i> <i>Set Options</i> <i>Set Turbo</i>	<ul style="list-style-type: none"> <li>• Change the name of a program list.</li> <li>• Change the period of time shown in the program guide</li> <li>• Create/edit up to four channel lists (Fav. A, Fav. B, Fav. C, Family)</li> <li>• Create a program listing that contains selected channels</li> <li>• Guide Options:                             <ul style="list-style-type: none"> <li>- Guide style (grid or Logo)</li> <li>- Picture in guide, zoom (on or off)</li> <li>- Multi-Color guide (on or off)</li> <li>- Channel Sort (numeric or alpha)</li> <li>- Filters (temporary or persistent)</li> <li>- Reset options to the default selections</li> <li>- Set and edit TurboTune guide channels</li> </ul> </li> </ul>
<b>Audio &amp; Video</b>	<i>Audio Adjustment</i> <i>Video Adjustment</i>	<ul style="list-style-type: none"> <li>• Set Default Audio language</li> <li>• Set Alternate Audio language</li> <li>• Set left/right audio balance</li> <li>• Select 4:3 or 16:9 screen ratio</li> <li>• Center menus on your monitor (up/down and right/left)</li> </ul>
<b>Caller ID</b>	<i>Caller ID</i>	<ul style="list-style-type: none"> <li>• See the names and telephone numbers of recent callers</li> </ul>
<b>Program Director</b>	<i>Schedule</i>	<ul style="list-style-type: none"> <li>• Automatically tune to programs for viewing or taping</li> </ul>
<b>WatchWord</b>	<i>Setup</i> <i>Results</i>	<ul style="list-style-type: none"> <li>• Search for programming using specific words</li> <li>• Display search results</li> </ul>
<b>Interactive</b>	<i>DIRECT TV INTERACTIVE™</i>	<ul style="list-style-type: none"> <li>• Access interactive programming features</li> </ul>
<b>Purchases</b>	<i>Upcoming &amp; Past</i> <i>Purchases</i>	<ul style="list-style-type: none"> <li>• View a list of scheduled pay per view events</li> <li>• Display recently purchased pay per view events</li> </ul>
<b>Locks &amp; Limits</b>	<i>Lock</i> <i>Fav Setup</i> <i>Rating</i> <i>Limits</i>	<ul style="list-style-type: none"> <li>• Lock and unlock the system</li> <li>• Set viewing times and maximum viewing hours</li> <li>• Create/edit up to four channel lists (Fav. A, Fav. B, Fav. C, Family)</li> <li>• Set maximum program rating allowed for viewing</li> <li>• Select programming content to be shown in the program guide</li> </ul>
<b>View Mail</b>	<i>Mail</i>	<ul style="list-style-type: none"> <li>• Read messages from DIRECT TV</li> </ul>
<b>System Setup</b>	<i>Install</i> <i>Signal</i> <i>VCR</i> <i>Prefs</i> <i>Test</i> <i>New Card</i> <i>Upgrade</i> <i>Features</i>	<ul style="list-style-type: none"> <li>• Determine proper antenna azimuth and elevation setting</li> <li>• Test signal reception</li> <li>• Setup VCR for unattended recording</li> <li>• Test system operation</li> <li>• Prepare a new access card</li> <li>• Display upgrade status and history</li> <li>• Display current receiver features</li> </ul>

### 4-16.6.18 Purchasing Pay Per View (PPV)

Select the Purchases menu tab to display lists of recently viewed and advance purchased pay per view events. You can choose **PAST PURCHASES** and **UPCOMING PURCHASES**. The event channel, title, start date and time, and cost is shown for each purchase.

The **PAST PURCHASES** pane shows recent pay per view events charged to your account. You cannot remove listed events. The list does not show:

- Events purchased, but later cancelled.
- Purchased, cancelable events to which the DIRECT TV® Receiver never tuned.
- Events ordered by calling DIRECT TV.

The **UPCOMING PURCHASES** pane displays:

- PPV events you have purchased but not yet viewed.
- PPV events purchased but never viewed.
- Events ordered by calling DIRECT TV do not appear on this list. For additional information about a specific event, highlight the event and press the INFO key.

#### To purchase a pay per view event:

1. Highlight the Buy menu pane option
2. Press SELECT
3. Press SELECT again to confirm your purchase.



**NOTE:** If you are not authorized for purchases using your DIRECT TV® Receiver, contact DIRECT TV for assistance.

**Canceling Purchases** - You may cancel some events after purchasing them. You can usually cancel unviewed purchases, however some events cannot be cancelled. If the Cancel Purchase button appears, you can clear the purchase. If this button is unavailable, part of the event has probably already been viewed, and you must accept the purchase.

#### To cancel a Pay Per View Event:

1. Highlight the event you want to cancel.
2. Press CLEAR on the remote control.
3. Use the pop-up menu panel to cancel the purchase.

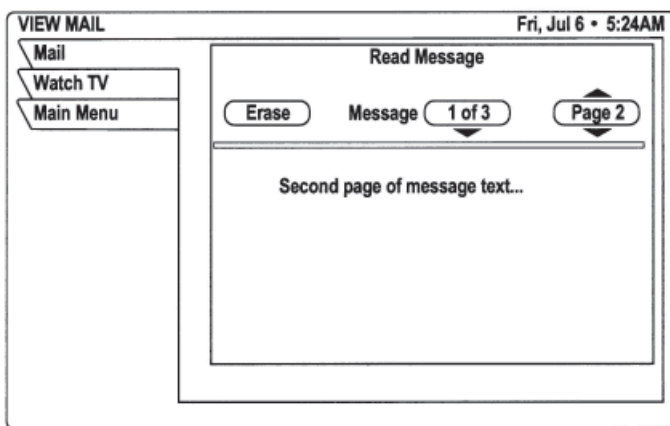

VIEW MAIL menu pane

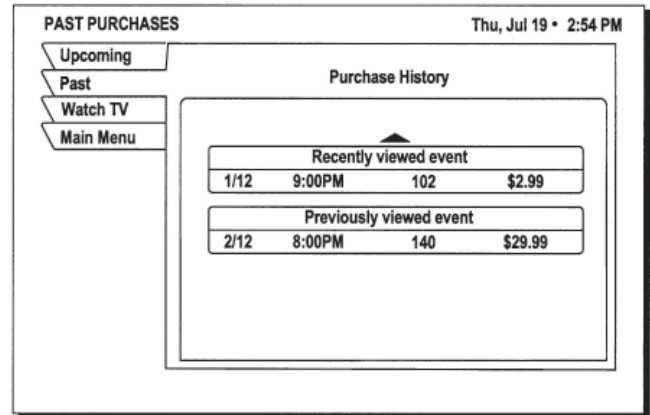

Pay per view purchases list

### 4-16.6.19 Viewing Mail

DIRECT TV uses the **MAIL** feature to send you important information, inform you of special events, and tell you about special offers. When you receive a new message, a New Mail icon appears at the top of all menus until you read the message. Highlight and SELECT the **View Mail** tab from the **MAIN MENU**.

**Message** - Cycle through multiple messages, SELECT the Messages button. Use the joystick to navigate messages.

**Page** - Use the CHANNEL (CH) button to cycle through multi-page message.

**Erase** - Permanently remove a message. Messages are automatically deleted as they become outdated or if space is needed for newer incoming messages.

### 4-16.6.20 Using Caller ID

Your DIRECT TV® Receiver shows you the name, time, and telephone number of recent calls on your TV as shown in the figure below.

Highlight and SELECT the Caller ID tab from the MAIN MENU.



**NOTE:** You must subscribe to Caller ID from your local telephone company to use this feature.

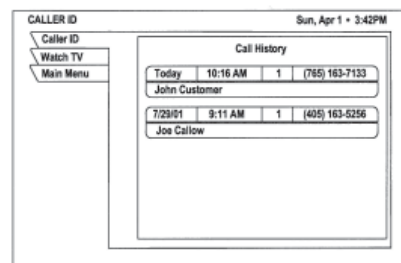

Call history screen

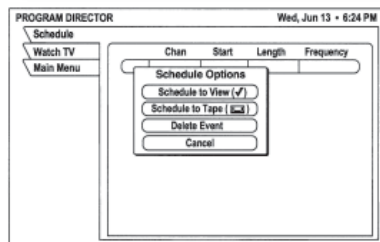

The PROGRAM DIRECTOR Schedule pane popup menu

### 4-16.6.21 Using the Program Director

You can program up to 32 events in advance for viewing or unattended recording. The PROGRAM DIRECTOR will tune to a program at a specific date and time, or tune on a repeating basis. As shown below, you can:

- Schedule programs for viewing (✓)
- Schedule programs for taping (📀)
- Select Cancel from the menu if you decide not to schedule anything.

**To schedule or edit an event** - The Schedule pane displays up to seven previously scheduled events at a time. If more than seven events are already scheduled, use the joystick to scroll down to view the additional events. Small arrows at the top or bottom of the list indicate that there are additional events.



**NOTE:** You can schedule events up to eleven months in advance.

#### To schedule a program:

1. Highlight an upcoming program in the program guide and press SELECT. Press SELECT again to cycle through the next available option.  
If you choose a scheduling option, the DIRECT TV® Receiver will turn on (if necessary) and tune to the specified channel at the chosen date and time.
2. If you chose Schedule to Tape and you have set up your VCR the DIRECT TV Receiver will record the event. For unattended recording:
  - Attach the VCR Control Cable and set up your VCR.
  - Set your VCR for the correct DIRECT TV Receiver output: RF (channel 3 / 4) or A/V (phono or S-Video).
  - Insert a blank videotape and leave the VCR turned on.



**NOTE:** To clear a scheduled event: Select Delete Event.

Use the joystick to specify AM or PM (or N for noon, or M for midnight )

3. Use the same procedure to set the program length in hours and minutes.
4. Use the joystick to advance to the Frequency column.
5. Specify when, or how often, the event occurs: Today, Tomorrow, Every Mon, Every Tue, Every Wed, Every Thu, Every Fri, Every Sat, Every Sun, Everyday, Mon-Fri, or "/" (specify a date).



**NOTE:** If you specify a date, use the month/day format. The year is set automatically.

After setting the Frequency, use the joystick to advance.

7. Review your settings and choose OK, or choose Cancel to delete the edits.

#### To cancel a program scheduled for viewing or taping:

Find the upcoming program in the program guide you wish to cancel and press SELECT until the check mark (✓) or videotape icon (📀) disappears.

If the program is currently airing, you must delete the event from the Schedule menu pane accessed from the PROGRAM DIRECTOR.



### 4-16.6.22 Setting Guide Preferences

Highlight and SELECT the Guide Options tab from the MAIN MENU. The Options screen (shown at right) allows you to customize operation to best suit your needs.

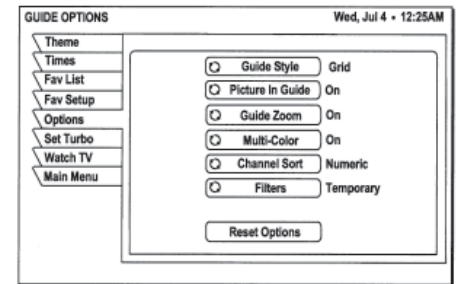

Selecting guide options

### 4-16.6.23 Adjusting Audio and Video

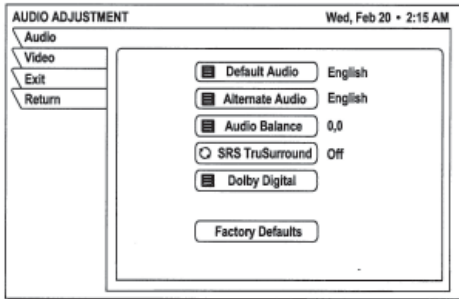

From the **MAIN MENU**, highlight and SELECT the **Audio & Video** tab. From the **AUDIO ADJUSTMENT** menu pane, you can change:

- Default Audio and Alternate Audio
- Audio Left/Right Balance
- TruSurround® Audio Processing
- Dolby Digital Output

**Setting Default and Alternate Audio** - Your DIRECT TV® Receiver supports alternate audio services. The **ALT. AUDIO** icon appears below the Information Banner or program guide date and time to indicate alternate audio is available for a particular program.

1. Press the remote control INPUT button to access these services.
2. Highlight the desired language.
3. Press SELECT.

Occasionally, an audio track may be offered that is not being broadcast, in which case the audio will not change or you will not hear any audio. Change channels to restore the audio track to the one specified on the **AUDIO ADJUSTMENT** menu.

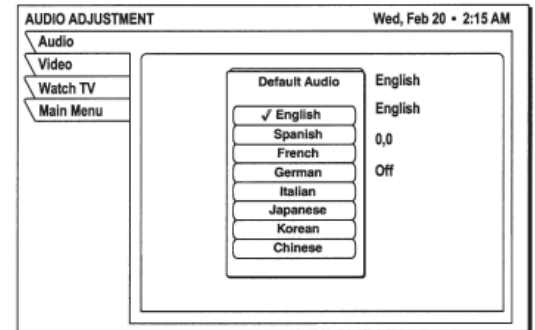

Setting the default audio language

**Using Dolby Digital Audio** (model GCEBOA only) Select the Dolby Digital audio, then use the CHANNEL (CH) button to step through the audio tracks for the current program. For programs that are offered in Dolby Digital, the double-D symbol ( **DD** ) appears with the audio track title.

**Adjusting Audio Balance** - To adjust the left/right audio balance, highlight and SELECT Audio Balance.

Use the **joystick** to increase or decrease balance settings in the pop-up menu.

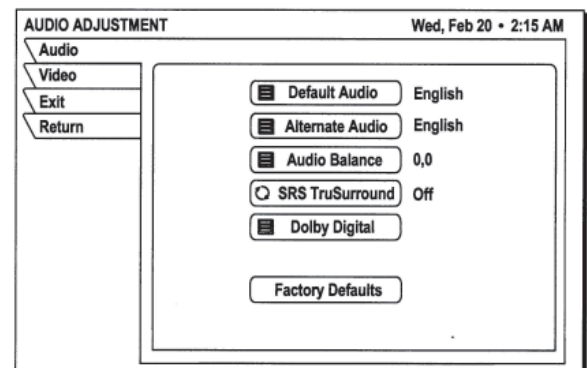

**Adjusting the Screen Image** - Adjust video display brightness, contrast, and saturation for the best image.

1. Highlight the **Audio & Video** tab from the **MAIN MENU**.
2. Press SELECT.
3. Highlight the *PicturePerfect* menu pane button.
4. Press SELECT.
5. Use the joystick to increase/decrease the screen *Brightness*, *Contrast*, and image *Saturation* settings in the pop-up menu (as shown right).

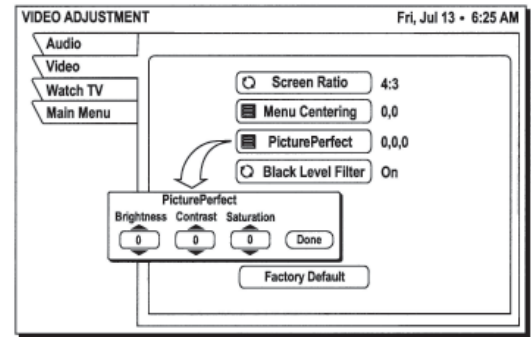

Adjusting screen image controls

### 4-16.6.24 Using WatchWord™

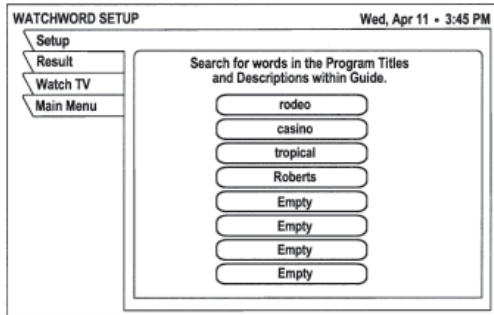

Search word entry list

Using WatchWord to search for specific words used in titles or descriptions. Press the remote control SEARCH button to access the setup pane shown.

You can specify up to eight search words or partial words to identify programming of interest to you. Program titles and guide descriptions containing your search words appear in the Result pane.

Highlight and SELECT one of the eight choices. A pop-up panel appears where you can enter a search word. If you entered "ALIEN," WatchWord might find the movie "Aliens" as well as any program which includes the word "alien" in the description.

Use the pop-up button board to enter search words. You can highlight and SELECT the toggle icon on the default button board to change it to a standard keyboard layout, if you desire. Highlight the desired letter using the joystick. Press SELECT to enter the letter. Select OK when you are finished entering the desired search words.

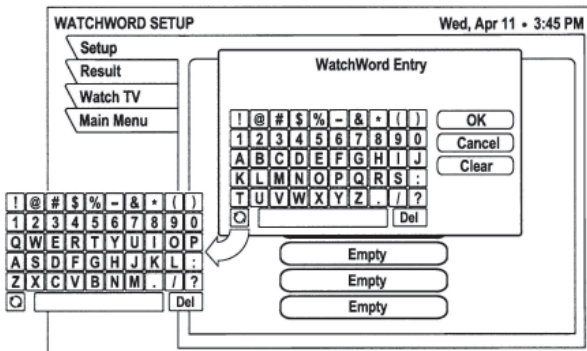

Using the toggle key to switch button board layout

### 4-16.6.25 Adjusting System Settings

Select the **System** tab from the **MAIN MENU** to access the system functions described in this section.

**New Access Card** - Highlight the **New Card** tab to set the receiver to use a new DIRECT TV® access card. SELECT the *Prepare new card* menu button and follow the on-screen instructions.

Use the **PREFERENCES** menu pane (shown in the figure below) to change the appearance of the on-screen menus and select how your DIRECT TV® Receiver operates with other devices. The **PREFERENCES** pane also allows you to:

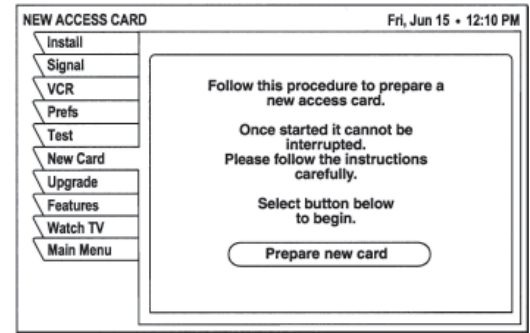

Prepare New Card menu pane

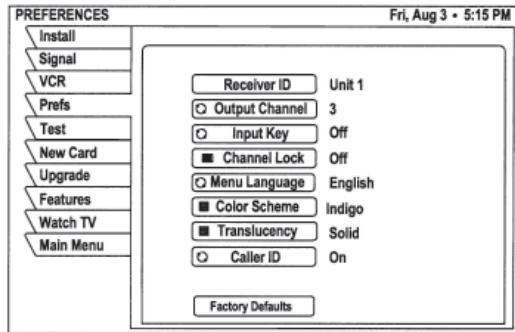

System Preferences menu pane

- Change the receiver ID
- Set the receiver output channel to channel 3 or 4.
- Enable or disable the INPUT button on your remote control.
- Lock the system on a particular channel.
- Select English or Spanish language menus.
- Enable or disable Caller ID on and off.

**Change Receiver ID** - If you are using:

- Multiple satellite receivers in the same room, or
- Multiple satellite receivers with the RF remote control on one of the receivers.

You may want to change the receiver ID to avoid interference or “cross talk.” The remote control receiver ID can be a number from “001” to “008”.

If you change receiver IDs, set your remote control to that ID number first. Use this procedure to set the remote control to use a different receiver ID:

1. From the **MAIN MENU**, highlight the **System Setup** menu tab. Press SELECT.
2. Highlight **Prefs** menu tab to display the **PREFERENCES** menu.
3. Highlight **Receiver ID** menu button.
4. Press and hold the remote control SAT button.
5. Press and release the MUTE button.
6. Release the SAT button. It should remain lit. If it does not, repeat steps 4-6.
7. Enter desired number (001 to 008).
8. Press the SAT button to lock in the code.
9. Point the remote control at the receiver. Press SELECT.

The number to the right the highlighted *Receiver ID* menu button will change to the new code. Check that the ID has been successfully set by testing the remote control to see that it controls that satellite receiver.

- Lock a channel** Use the Channel Lock menu button to set the DIRECT TV® Receiver to permanently stay on a specific channel. When you enter a channel number (5-0-0, for example) then select OK, the receiver will always power up on that channel (channel 500 in this example). The receiver will ignore any attempts to change the channel. Set this option to “Off” to permit normal channel selection.
- Select menu language** The Menu Language button allows you to display on-screen menus in English (default) or Spanish.
- Change color schemes** You may select a menu color combination, or scheme, from these choices: Indigo, Ice, Sky, Forest or Merlot.
- Set translucency level** The translucency level of the on-screen display may be set to Solid, Heavy, Medium, or Light.
- Caller ID enable/disable** Use the Caller ID menu button to turn the Caller ID feature on and off. Incoming calls will not be displayed on-screen when the Caller ID feature is disabled.
- Restore factory default settings** SELECT the Factory Defaults menu button to restore the PREFERENCES options to the original factory settings.  
Antenna, Signal, and Test functions are described in the [Getting Started Section](#) found earlier in manual

### 4-16.6.26 Using Program Guides

This section includes:

- The different program guide styles
- Common program guide and menu features
- How to use the OneLine™ Guide
- How to set-up and use the TurboTune™ Guide

### 4-16-6.27 Selecting a Program Guide Style

Personalize the program guide to show program listings that interest you. You determine how your choices appear onscreen by your guide selection. Available guide styles are:

- Grid with Picture-in-Guide or description
- Logo with Picture-in-Guide or description

#### Grid Guide

- Easy to see what programs are available at a particular time
- Shows up to 72 hours of current and upcoming programming.
- Picture-in-Guide displays the current program in the upper right corner.
- You can browse five channels of current and future programming at a time.
- Activate ad highlights provide “one-click” access to products and services.
- Programs appear in a row with the channel on which they are broadcast.
- Browse up or down one channel at a time with the joystick when the highlight is in the grid.
- Use the remote control CHANNEL (CH) button to scroll through a full page of guide entries at a time.
- Move the highlight to the right to show future programming.

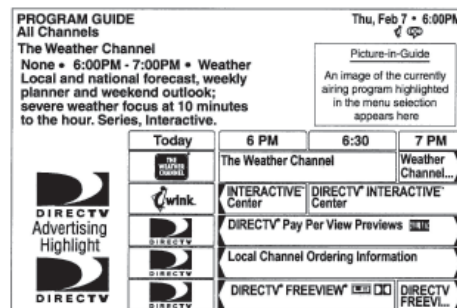

**NOTE:** Cells with arrows indicate the program started at an earlier time or continues later than can be shown in the selected time period.

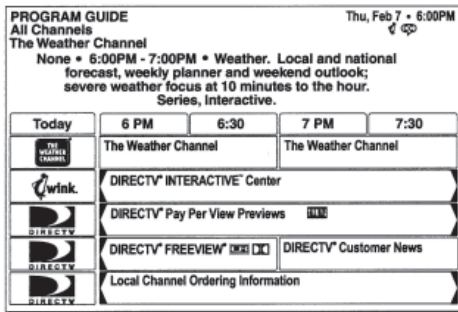

The guide time expands on two hours when active ad highlights are not available. You can also turn the Picture-in-Guide feature off as shown in the figure at left.

**NOTE:** If a program title cannot entirely fit in the space provided, an ellipsis (...) indicates that a portion of the title is not shown.

**To turn off the Picture-In-Guide feature:**

1. Press the remote control GUIDE button.
2. Press the GUIDE button again to access the Options menu tab.
3. Highlight the Picture-in-Guide menu button.
4. Press SELECT to toggle the feature off.

**NOTE:** Press the remote control GUIDE button while the program guide appears on-screen to display the Guide Options menu.

**Logo Guide**

- Select your favorite channels, rather than selecting specific programs.
- The current program title appears above the logo grid as you highlight each channel. Only current programming is available in the Logo Guide.

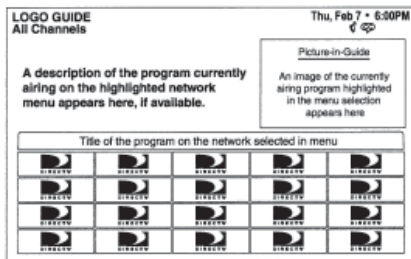

Logo guide with Picture-In-Guide active

- Video of the current program appears in the Picture-in-Guide window as you highlight each channel.

Use the Channel (CH) button to scroll through the guide entries a full page at a time, or use the joystick to scroll through the guide entries one at a time.

You can display the most channels per screen by turning off the Picture-in-Guide feature, using the description-only mode.

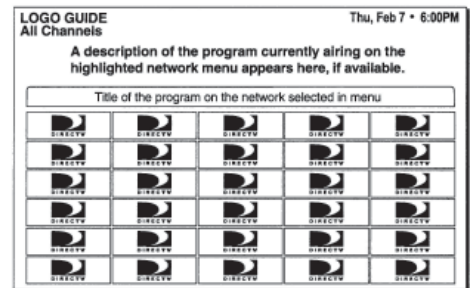

Logo guide with Picture-In-Guide disabled (description-only mode)

**To select a guide style:**

1. Press the remote control MENU button.
2. Use the joystick to highlight and SELECT the **Guide Options** menu tab.
3. From the **Options** menu tab, highlight your selection and press SELECT.
4. Highlight and SELECT the **WatchTV** tab to return to the program you were viewing.

**4-16.6.28 Program Guide and Menu Features**

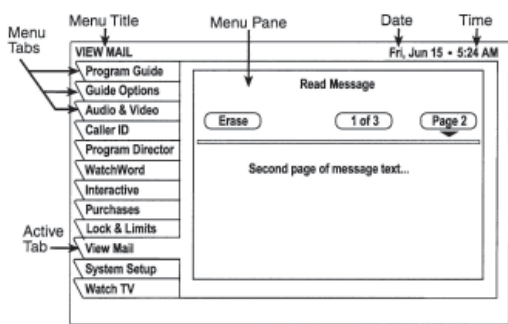

The on-screen guides and menus provide a logical and convenient way to access system features and settings. Every guide and menu contains these elements:

- The guide or menu title
- The day of the week, date, and time appear in the upper right corner
- Menu pane selection tabs

Use the joystick to move the highlight from tabs into menu panes.

Below the date and time, small icons indicating the status of the system or details about the currently highlighted program title may appear. These icons also appear in the Channel Banner. See illustration on following page.



The Channel Banner appears at the top of the screen whenever you use the CHANNEL(CH) button to change channels. Press the remote control INFO button to display the banner at any time.

Icon												
Meaning	Pay per view	Interactive programming available	Dolby Digital audio available	Closed caption available	Unread mail	Limits enforced	Limits override	Taping not allowed	Other audio available	Data available	All Day Ticket	Letter Box format

Channel Banner Icons

More detailed information appears in the Info Banner beneath the Channel Banner if you press the INFO buttons a second time. Banners disappear from the screen after a few seconds, but you can remove them from the screen instantly by pressing the CLEAR button on the remote control.

### 4-16.6.28 The OneLine™ Guide

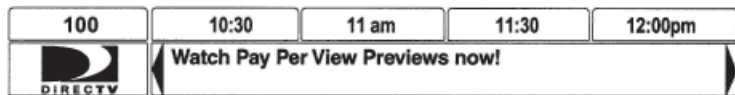

OneLine Guide

The OneLine™ Guide appears across the bottom of your screen when you press the joystick up or down while watching TV. You will see the channel call sign and number, titles, and program start and end times as shown at left.

- Use the joystick to scroll to the right to see upcoming program titles.
- Display current or future program information in the Channel Banner by pressing the remote control INFO button.
- Use the joystick to move up or down while using the OneLine Guide to see the next or previous available channel. Press SELECT to tune to the channel.
- You can also enter a channel number using the numeric keypad to display the OneLine Guide for that channel. OneLine content varies according to **FAV LIST** menu selections and other filters.
- Press the CLEAR button on the remote control to instantly remove the guide.

### 4-16.6.29 Using TurboTune™

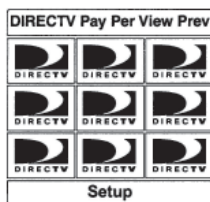

TurboTune Menu

The TurboTune™ feature is a quick guide to nine of your favorite channels.

Press the TURBO button on the remote control to show the TurboTune panel.

Use the joystick to highlight the desired channel. The panel header displays the title of the program currently airing on the highlighted channel.

Press SELECT to tune to that channel.

#### To set TurboTune channels:

- Select Guide Options from the MAIN MENU, then use the Set Turbo menu tab or
- Press the TURBO button on the remote control then SELECT the Setup pane below the TurboTune Menu.
- Highlight an unassigned channel box and press SELECT.
- Enter the desired channel using the joystick, numeric remote control buttons, or the CHANNEL(CH) button.

### 4-16.6.30 Setting Favorites and Filters

This section includes:

- How to create a channel list
- Renaming a channel list
- Using Auto Set, Add All, and Del All functions
- How to filter the program guide
- How to change guide times

### 4-16.6.31 Using Favorite Channel Lists

Channel Lists are provided to help you organize the hundreds of available channels into groupings suitable for your household. Each list can contain as many or as few channels as you wish. You can customize these groups several ways. For example, **Fav. A** could be Dad's favorite channels, **Fav. B** could be Mom's favorites, **Fav. C** could be the kids' channels, and **Family** could be all channels that Mom and Dad have deemed appropriate for the entire family.

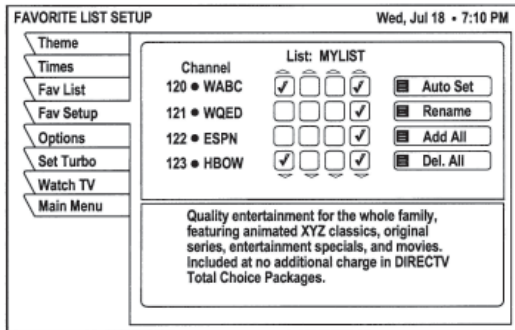

#### Creating a Channel List

1. Press the remote control **MENU** button.
2. Select the **Guide Options** from the **MAIN MENU**.
3. Use the joystick to highlight the **Fav Setup** tab.
4. Press SELECT to open the **FAVORITE LIST SETUP** pane shown below.

The four columns of small boxes on the right hand side of the pane are the Tag Boxes. The first three columns are the **Fav. A**, **Fav. B**, and **Fav. C** channel lists. The farthest right hand column is the **Family** list.



**NOTE:** If the receiver is locked, only existing Family list channels are accessible. If the Family list has not had channels added to it, no channels can be viewed without first unlocking the receiver. To avoid this inconvenience, create the Family list before locking the receiver. See [Using Access Controls](#) section later in manual for additional details about controlling system access.

5. Use the joystick to highlight the tag box that corresponds to the channel number and list that you wish to create or change.
6. Press SELECT to add or remove the check mark, which indicates that the channel in that row is included in the list shown at the top of the column. To help you decide whether to include or exclude a certain channel, the title of the program currently airing on that channel appears at the top of the screen.
7. Scroll up or down to view channels and descriptions. Press SELECT to add channels to your list.
8. When you have added all of the channels you want to your list, use the joystick to highlight and SELECT the **Watch TV** tab to resume viewing.

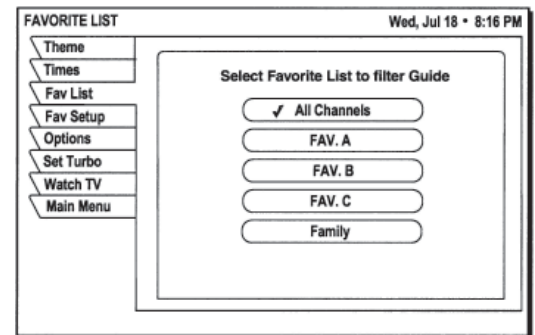

Once you have created your lists, use the remote control FAV button to cycle through them quickly and easily. Each press cycles to next channel list. You can also select a list by highlighting the Fav List tab.

#### Renaming a Channel List -

1. Highlight the **Rename** button and press SELECT.  
A **Rename List** pop-up menu appears. You can rename the first three lists. You cannot rename the **All** and **Family** lists.
2. Highlight the list you wish to rename and press SELECT. A button board pop-up panel appears.
3. Highlight the desired letter using the joystick.
4. Press SELECT to enter the letter.
5. When finished, Select **OK**.

#### Creating an Auto Set List -

1. SELECT the **Auto Set** button. A pop-up menu appears showing each of the channel lists.
2. Highlight and SELECT a channel list to be programmed.

Once selected, the **Auto Set Progress** pop-up status panel appears. It may take several minutes for the receiver to scan through all of the channels and determine which ones you are authorized to receive. The results of this scan will be stored in the designated channel list.

**NOTE:** Auto Set may exclude some channels such as the Music Choice channels or include some pay per view channels. This does not mean that the receiver is faulty. These channels were excluded or included due to the DIRECT TV® Receiver's analysis process. You can manually edit the lists to correct these oversights.

**Adding and Removing All Channels**

Selecting the **Del All** menu button clears all channels from the list you have chosen. **Add All** has the opposite effect, creating a list of all the channels you are authorized to receive.

**4-16.6.32 Filtering the Program Guide**

Press the remote control GUIDE button while in a guide. A pop-up menu provides filtering tools and ways to access other guide styles. By combining each of these filter options, you can quickly narrow down channels to those that match your viewing interests.

**Using Theme Filters** - From the **MAIN MENU**, SELECT the **GUIDE OPTIONS** tab. The **CATEGORY FILTER** menu appears, listing all available program category groups.

After choosing a category (other than All), the drop-down menu is replaced by the Types pop-up menu. This menu allows you to further refine a chosen theme. In addition to All, you can select popular categories that can be quickly selected using the remote control GUIDE button.

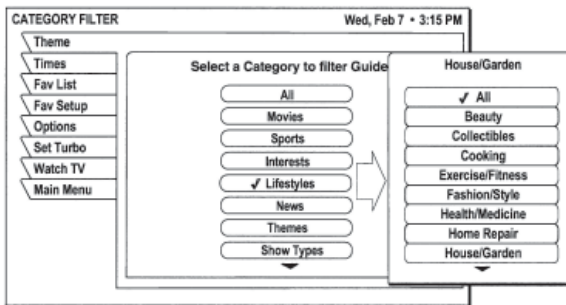
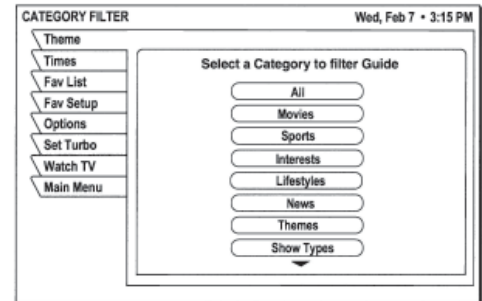

For example, if you select Lifestyles for the category, you can then choose a subcategory such as Beauty, Collectibles, Cooking, Exercises/Fitness, and others as shown in the figure below.

After selecting one of these subcategories, the guide will be further filtered to show only those channels offering programs of the selected category and type.

**Selecting Guide Times** - Highlight the **Times** menu tab. The **GUIDE TIMES** menu shown below provides easy access to future programming information. Simply select the time you want the guide to begin. After a few seconds, the selected guide appears.

**4-16.6.33 Using Access Controls**

This section includes:

- How to lock and unlock the system
- How to set a maximum ratings limit
- Setting maximum spending and time limits

**Locks & Limits** provide settings to help you control the viewing restrictions of DIRECT TV® programming. When accompanied by the channel lists, these limits provide a great degree of control. The DIRECT TV® Receiver must be locked for the TV Timer, Rating and Spending limits to be enforced.

**4-16.6.34 Locking & Unlocking the System**

When you first receive your satellite system, it will be unlocked; (i.e., no limits or restrictions are in effect). You must lock the system to enforce the limits (spending, ratings, TV timer, and "Family" favorite list).

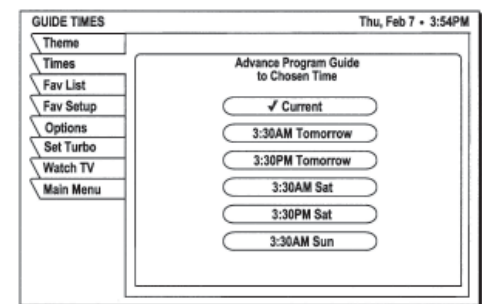



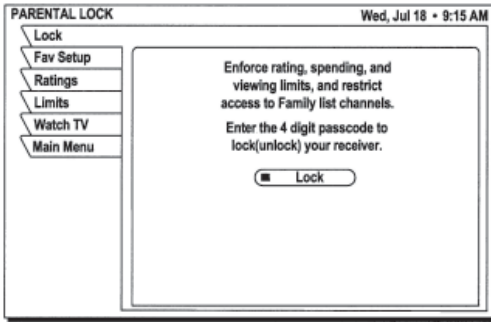

**NOTE:** Once the DIRECT TV Receiver is locked, only existing Family list channels will be accessible. If the Family list does not contain any channels, no channels can be viewed without first unlocking the receiver. To avoid this, verify the contents of the Family list before locking the receiver.

**How to Lock the System** - When you SELECT the Lock button, the LOCK SYSTEM pop-up panel appears.

1. Enter a four-digit passcode using the remote control.
2. Highlight and SELECT OK.
3. Enter the code again to confirm.
4. Highlight and SELECT OK.

**NOTE:** Pressing Cancel will clear the locking process.

Once you select OK, the satellite receiver is locked. You must enter the passcode to unlock it. A lock symbol icon appears at the top of every menu screen to remind you that the system is locked.

**NOTE:** If you forget your four-digit code, you must call DIRECT TV.

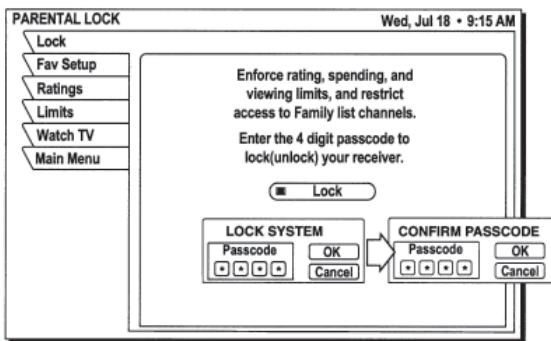

**Unlocking the System** - To remove the lock and its restrictions:

1. Highlight the **Locks & Limits** tab from the **MAIN MENU**.
2. SELECT the **Unlock** menu button.
3. Enter the code you entered to lock the system.

**NOTE:** The button used to lock the system is also used to unlock the system.

Once the system is unlocked, **all limits and restrictions are removed!** Choose **Cancel** to keep the lock in effect.

**Setting Rating Limits** - Program ratings indicate the suitability of a program's content for a given audience.

1. Highlight the Ratings tab.
2. Highlight and SELECT the type of programming content you wish to restrict.

For example, if you select the Violence menu button, a ratings pop-up submenu appears as shown in the following figure.

Highlight and SELECT the highest rating for violent program content you wish to allow. You may choose to **Block All** or **Allow All** instead of setting a specific limit.

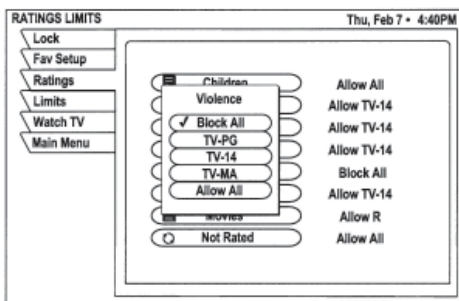
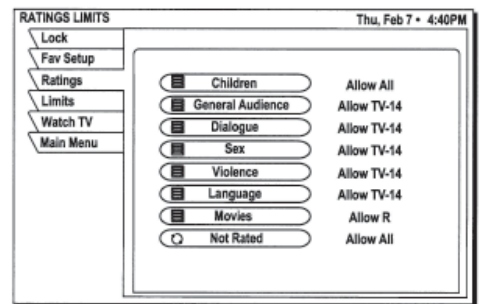

**Setting Spending and Time Limits** - Highlight the **Limits** tab to set the maximum spending limit. You can set the maximum purchase price on a per-event basis.

### To change the displayed limit:

1. Highlight the **Max Spending** button
2. Press SELECT to display the **SPENDING LIMIT** pop-up panel.

Use this menu to set the specific hours and maximum hours the satellite receiver can be used for viewing.

3. Use the number buttons on the remote control to set the limit or use the joystick to increase or decrease each digit.
4. Use the joystick to highlight the digit that you want to change. The maximum limit is \$655 per event.
5. Highlight **OK** and press SELECT to confirm the entered amount.

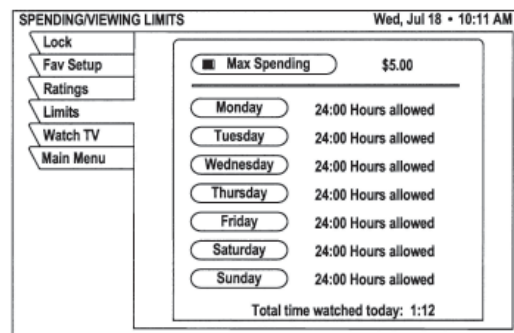

## 4-16.6.35 Questions and Answers

**Questions?** Did we leave something out? Below is a list that was compiled consisting of the most common questions and their answers.

- Q** *I had a signal but now I am getting a message “Searching for satellite signal. To access related utilities, press SELECT.” What happened?*
- A** Rain clouds and snow can affect the satellite signal reception. This loss of signal is temporary. Also check for new growth on trees and bushes that could be blocking the signal. One other possibility is that the wind or someone has moved the satellite dish antenna.
- Q** *Why can't I control my TV?*
- A** Before you can control your TV, VCR, or any other device besides your satellite receiver, you must program your remote control to match your different devices. See [Using the Remote Control](#) section in this manual for specific instructions. If you have already successfully programmed your remote control, try pressing the appropriate key to put your remote in the proper mode. Then try controlling that device. Also, make sure that the batteries in the remote control are good.
- Q** *My satellite receiver does not respond when I press keys. What's wrong?*
- A** Most likely, if the front panel keys work but the remote control doesn't work, try pressing the SAT button before trying to control the digital satellite receiver. If that doesn't work, press the SAT and MUTE buttons together and try again. If that doesn't work, or if the front panel buttons don't work either, unplug your digital satellite receiver for 30 seconds, then plug it back in. Your satellite receiver is a computing device. It is susceptible to erratic changes in power and/or signal, just as any other computer, and these sudden changes can cause it to become “confused.”
- Q** *Some channels look good, while others freeze or indicate that no signal is available. What's wrong?*
- A** The most common causes for this behavior relate to an improperly grounded satellite cable. Check the cable between your digital satellite receiver and the satellite dish antenna. Confirm that RG-6 (not RG-59) cable is used and does not exceed 100 feet in length. Longer cable runs require amplification. This special amplifier is available from your dealer.
- Q** *How can I watch one channel while recording another?*
- A** With only one digital satellite receiver, unfortunately, you can't. Each receiver can only decode one channel at a time.
- Q** *I'm getting a message to call some extension, Why?*
- A** There are many different reasons for this. If you want to watch the channel that is displaying the message, call DIRECT TV at 1-800-531-5000.
- Q** *Why don't I have an on-screen offer to purchase pay per view programs?*
- A** There are three possibilities; your digital satellite receiver must be connected to a phone line and it is not, or DIRECT TV doesn't realize that your phone line is connected or has disabled your ability to make on-screen purchases. Call DIRECT TV at 1-800-531-5000 for assistance.

**Q Can I receive my local TV programs through my digital satellite receiver?****A** There are three ways to receive local programming:

1. If you are in an area where local programming is available via satellite and have the proper satellite dish antenna, contact DIRECT TV to arrange for the necessary subscription package.
2. Install a traditional antenna (i.e., roof mounted, attic mounted, rabbit ears).
3. Arrange for basic or "lifeline" cable TV service from your local cable company.

If you select item 1 above, your local programming appears in the program guide like any other channel. For options 2 and 3, connect the local signal to the IN FROM ANTENNA jack on the back of your digital satellite receiver. Use the INPUT key to switch between DIRECT TV® programming and local programming provided on the OUT TO TV connector.

**Q I don't see Caller ID information appear on screen when I receive a telephone call. What could be wrong?****A** There are several possible reasons. First, check that the satellite receiver is connected to an active telephone jack. Verify that the Caller ID feature is turned on. Confirm that you subscribe to Caller ID service from your telephone company. Also check that your antenna is properly grounded as shown previously, as this can affect how the Caller ID feature works.**Q If I have questions about my satellite system or need to have it serviced, who should I call?****A** For issues regarding your equipment, contact Hughes Consumer Care Center directly at 1-800-274-8995, or if you prefer, call your dealer first. They are most familiar with your installation and needs. Also, they are likely to be local to you.

If you need assistance with your subscription, such as adding channels, contact DIRECT TV at 1-800-531-5000.

**Q I think I set an event to record on my VCR, but when I played the tape back nothing was there. What could be wrong?****A** There are several possible reasons for this. First, check that the VCR was programmed correctly and left turned on and the input matches the output from your digital satellite receiver. Confirm that you were authorized to tape the chosen program.**Q Why do I need to connect the satellite receiver to a telephone line?****A** The telephone connection is used by the satellite receiver report purchase activity to DIRECT TV.**Q I picked up my telephone and it was making a hissing and squealing sound. Why?****A** Your digital satellite receiver was reporting any pay per view activity that may have occurred. This rarely happens and only lasts for a minute or so.**Q What if my question isn't answered here?****A** Call your dealer or Hughes Consumer Care Center at 1-800-274-8995. We will do our very best to answer your questions.

### 4-16.6.36 Manufacturers Device Control Codes

Use these codes to program your remote control to operate your system components.

BRAND	CODE NUMBER	BRAND	CODE NUMBER
Aiwa	034	MEI	031
Akai	016, 043, 046, 124, 125, 142, 146	Memorex	102, 101, 003, 010, 014, 031, 034, 053, 072, 139, 134
Ampro	072	MGA	045, 046, 059
Anam	031	Minolta	001, 156
Audio Dynamics	012, 023, 039, 043	Mitsubishi	001, 059, 061, 046, 051, 142, 045, 162
Broksonic	035, 037, 044, 129, 152	MTC	034, 040
Canon	028, 031	Multitech	024, 034
Capehart	108	NEC	012, 023, 043, 048, 039
Craig	003, 040, 135	Nordmende	043
Curtis Mathes	031, 041, 156	Optonica	053, 054
Daewoo	117, 119, 005, 116, 007, 010, 065, 108, 110, 112	Panasonic	070, 133, 031, 066, 160, 161
Daytron	108	Pentax	001, 013, 063, 156
Dimensia	156	Philco	031, 034, 067
DBX	012, 023, 039, 043	Philips	031, 067, 034, 101, 054, 071
Dynatech	034, 053	Pilot	101
Electrohome	059	Pioneer	021, 013, 048
Emerson	006, 029, 035, 025, 027, 034, 036, 037, 046, 101, 129, 131, 138, 017, 031, 044, 152, 157, 153	Portland	108
Fisher	003, 008, 009, 101	Quartz	002, 014
Funai	034	Quasar	070, 133, 160, 161, 031, 066
GE	031, 072, 144, 147, 063, 151, 107, 109, 156, 126	Radio Shack	123
Go Video	040, 132, 136	RCA	001, 107, 109, 144, 147, 151, 041, 034, 040, 156, 031, 140
Goldstar	101, 123, 012, 001, 114	Realistic	003, 008, 010, 014, 031, 034, 040, 053, 054, 101
Harmon Kardon	012, 045	Rico	057, 078
Hughes	001	Salora	014
Hitachi	001, 026, 034, 063, 137, 150, 156	Samsung	102, 040, 032, 104, 107, 109, 112, 113, 115, 120, 122, 125, 159
Instantreplay	031	Sansui	043, 048, 135, 022
JCL	031	Sanyo	003, 010, 102, 007, 014, 134
JCPenney	001, 012, 040, 101, 156, 066	Scott	017, 037, 044, 129, 131, 112, 159
Jensen	043	Sears	001, 003, 008, 009, 010, 014, 017, 081, 101
JVC	048, 050, 043, 130, 060, 012, 031, 150, 055, 158	Sharp	031, 054, 053
Kenwood	014, 034, 047, 048, 023	Shintom	024
Lloyd	034	Signature	034
LXI	034, 003, 009, 017	Sony	003, 031, 052, 056, 057, 058, 149, 155
Magin	040	Soundesign	034
Magnavox	067, 031, 034, 041, 068, 154, 160, 064	STS	001
Marantz	067, 069, 031, 012, 023	Sylvania	031, 059, 034, 067
Marta	101	Symphonic	034
Matsui	027, 030		

Table 1: VCR Brands and Remote Control Codes

BRAND	CODE NUMBER
Tandy	010, 034
Tatung	039, 043, 023
Teac	034, 039, 043, 023
Technics	031, 070
Teknica	031, 019, 034, 101
TMK	006
Toshiba	112, 008, 131, 047, 059, 082, 001, 042
Totevision	040, 101

BRAND	CODE NUMBER
Unitech	40
Vector Research	012
Video Concepts	012, 046, 034, 141
Videosonic	040
Wards	003, 001, 024, 031, 034, 040, 053, 054, 017, 131
Yamaha	012, 043, 034, 039
Zenith	072, 080, 056, 048, 034, 101, 058

Table 1: VCR Brands and Remote Control Codes - Continued

BRAND	CODE NUMBER
Admiral	072, 081, 160, 161
A Mark	112, 143
Akai	070, 146
Amstrad	052
Anam	043, 054, 056, 080, 112
AOC	070, 004, 058, 112
Audiovox	076, 120
Blaupunkt	088
Cairn	206
Candle	070, 002, 003, 004
Capehart	058
CCE	001, 004, 024
Cetronic	043
Citizen	070, 002, 003, 004, 043, 101, 103, 143
Classic	043
Concerto	004
Contec	043, 050, 051
Coronado	143
Craig	043, 054, 191
Crown	043, 143
Curtis Mathes	070, 101, 143, 004
CXC	043
Daewoo	076, 103, 004, 016, 043, 114, 120, 127, 143, 128, 136, 192, 044
Daytron	004, 143
Dynasty	043
Dynatech	062
Electrohome	024, 076, 120, 143
Emerson	004, 005, 028, 043, 047, 048, 050, 051, 076, 120, 143, 151, 153, 154, 155, 070, 096, 191

BRAND	CODE NUMBER
Fisher	007, 057
Fujitsu	198
Funai	028, 043
Futuretech	043
GE	160, 165, 161, 070, 008, 009, 034, 056, 073, 074, 130, 155, 167, 004, 145
Goldstar/LG	004, 106, 110, 112, 119, 127, 143, 193
Gradiente	004, 038, 106
Hall Mark	004
Hitachi	007, 011, 004, 009, 010, 012, 023, 072, 075, 143, 158
Infinity	164
JBL	164
JCPenney	070, 004, 008, 009, 024, 030, 065, 101, 160, 143, 156
Jensen	013
JVC	001, 034, 038, 083, 199
KEC	043
Kenwood	070, 001
Kloss	002, 059
KMC	143
KTV	043, 143, 154, 070
Lodgenet	072
Logik	072
Luxman	004
LXI	007, 015, 052, 081, 160
Magnavox	003, 004, 022, 059, 060, 061, 063, 064, 070, 094, 127, 160, 164
Marantz	070, 164
Matsui	164
Memorex	004, 007, 072
Metz	088

Table 2: Television Brands and Remote Control Codes

<b>BRAND</b>	<b>CODE NUMBER</b>
MGA	023, 070, 004, 023, 028, 042
Minerva	088
Mitsubishi	004, 023, 040, 043, 028, 146
MTC	070, 004, 062, 101
NAD	015, 025
NEC	070, 040, 016, 056, 024, 130, 134, 019, 004
Nikei	043
Onking	043
Onwa	043
Optonica	019, 081
Orion	201, 202, 203, 204, 205
Panasonic	034, 080, 056, 164
Philco	070, 003, 059, 060, 064, 004, 056, 063, 023, 164
Philips	164, 093, 038, 005, 059, 127, 070, 003, 004
Pioneer	025, 070, 004, 018, 023, 190
Portland	004, 143, 165
Proscan	160, 161, 167, 145, 065
Proton	004, 058, 112, 143, 171, 173
Quasar	034, 056, 080, 164
Radio Shack	004, 019, 043, 127, 143
RCA	160, 161, 156, 165, 070, 004, 023, 024, 056, 074, 153, 167, 145
Realistic	007, 019, 043, 047
Runco	072, 130
Sampo	004, 070, 058, 207
Samsung	101, 004, 050, 089, 105, 160, 127, 143, 133
Sanyo	007, 020, 053, 057, 082
Scott	004, 028, 043, 048, 143
Sears	015, 030, 028, 094, 004, 007, 057, 082, 143, 160, 167
Seleco	200

<b>BRAND</b>	<b>CODE NUMBER</b>
Sharp	081, 004, 014, 019, 022, 028, 143
Siemens	88
Signature	72
Sony	001, 085, 126, 166, 079
Soundesign	028, 003, 004, 043
Spectricon	112
SSS	004, 043
Supre Macy	002
Sylvania	003, 044, 059, 060, 063, 064, 070, 127, 160, 164
Symphonics	194, 052
Tandy	081
Tatung	056, 062
Technics	034, 080
Techwood	004
Teknika	002, 003, 004, 024, 028, 043, 072, 101, 143
Telerent	072
Tera	173
TMK	004
Toshiba	015, 030, 007, 040, 062, 101
Universal	008, 009
Video Concepts	146
Vidtech	004
Wards	004, 019, 064, 008, 009, 028, 060, 061, 063, 072, 074, 143, 164, 165
Westinghouse	076, 120
Yamaha	004, 070
York	004
Yupiteru	043
Zenith	072, 073, 095, 103
Zonda	112

Table 2: Television Brands and Remote Control Codes - Continued

BRAND	CODE NUMBER
Adcom	146, 149, 227, 244
AMC	083, 084
Arcam	100
Audio File	093, 098
Audio Technica	221
Aiwa	111, 114, 117, 156, 170, 199, 203, 219, 231, 241, 254
Akal	181, 233
Anam	180
Bose	064, 137, 219
B & K	150, 152
Carver	013, 098, 107, 126, 129, 160, 163, 220, 245, 249
Clarion	151, 169
Denon	101, 133, 191, 202, 208, 246, 247
Enlightened Audio	078, 153
Fisher	107, 129, 157, 163, 176
Fosgate Audionics	228, 248
GE	216, 123
Harmon Kardon	073, 195, 248, 249
Haitai	119
Hitachi	088
JCPenney	109, 154, 178
Jensen	099
Jerrold	141
JVC	112, 198, 252
Kenwood	096, 104, 119, 125, 148, 151, 163, 171, 173, 242
Krell	223
Lexicon	215, 250
Luxman	066, 120, 205, 229
LXI	123, 177
Magnavox	126, 162, 185, 186, 224, 228
Marantz	074, 105, 126, 128, 139, 155, 162, 186, 232
McIntosh	251
Mondial	069, 225

BRAND	CODE NUMBER
MCS	108, 178
Mitsubishi	253
Meridian	013, 067
NAD	128
Nakamichi	072, 212, 234, 235
Niles	236
Onkyo	094, 115, 116, 209, 211, 255
Optimus	121, 125, 140, 181
Panasonic	131, 144, 187, 200
Parasound	085, 086, 090
Philips	136, 186, 126, 197
Pioneer	093, 132, 138, 210, 165, 189, 195, 201, 081, 230
Quasar	131, 187
RCA	109, 213, 166
Realistic	103, 122, 123, 124, 172, 174, 177, 179, 180, 194
Rotel	204, 218, 239
Sansui	196, 214, 126, 139, 075, 197
Sanyo	157, 129
Samsung	068
Scott	180, 190
Sharp	096, 125, 151, 161, 169, 182, 193
Sherwood	089, 127
Sony	097, 117, 147, 183, 200, 253, 237, 238, 188, 192
Soundstream	197
Starcom	141
Symphonic	124
Teac	102, 159, 180, 062
Technics	131, 184, 187, 200, 202, 208, 165
Toshiba	175
Wards	163
Yamaha	092, 120, 166, 240, 125, 169, 216
Zenith	222, 061

Table 3: AUX Audio Brands and Remote Control Codes

BRAND	CODE NUMBER
Hamlin	015, 017, 022
Jerrold/G.I.	010, 021, 025
Oak	008, 016, 023
Pioneer	007, 026, 027

BRAND	CODE NUMBER
Scientific Atlanta	002, 006, 013
TOCOM	003
Zenith	004

Table 4: AUX-CATV Brands and Remote Control Codes

BRAND	CODE NUMBER
Alpine	009
Apex Digital	076
Denon	030, 226
GE	035, 036
Goldstar, LG	028, 041
Harmon Kardon	217
Hitachi	011
JVC	031
Magnavox	038, 042, 008
Marantz	006, 007
Mitsubishi	032
NAD	077

BRAND	CODE NUMBER
Onkyo	207
Panasonic	003, 039
Philips	038, 042, 006, 007
Pioneer	034, 005, 010
Proscan	035, 036
RCA	035, 036
Samsung	029, 040
Sharp	004
Sony	037
Toshiba	038, 001
Yamaha	039, 079
Zenith	028, 041

Table 5: DVD Player Brands and Remote Control Codes

BRAND	CODE NUMBER
California Audio	047
Denon	043, 044
Fisher	047
Kenwood	060
Magnavox	048, 057
Mitsubishi	057
NAD	057
Optimus	049
Panasonic	047, 051, 054
Philips	048
Pioneer	055, 057

BRAND	CODE NUMBER
Quasar	047
Radio Shack	056
RCA	046
Realistic	049
Runco	058
Sanyo	052
Sharp	060
Sony	050, 053
Technics	047, 051, 054
Toshiba	060
Yamaha	045, 059

Table 6: DVD-Laser Disc Player Brands and Remote Control Codes



## 4-16.7 AV System General Information

### 4-16.7.1 Front A/V System

*To watch cable without amp;*

1. Turn on monitor and change channels via monitor .

*To watch terrestrial antenna without amp;*

1. Turn on monitor and change channels via monitor .

*To watch satellite without amp;*

1. Turn on monitor set to channel 4.
2. Turn on SATELLITE system and change channels via SATELLITE system.

*To watch cable with amp;*

1. Turn on monitor set to input 1.
2. Turn on AMP set to VCR.
3. Turn on VCR and change channels via VCR.

*To watch terrestrial antenna with amp;*

1. Turn on monitor set to input 1.
2. Turn on AMP set to VCR.
3. Turn on VCR and change channels via VCR.

*To watch satellite with amp;*

1. Turn on monitor set to input 1.
2. Turn on AMP set to TV.
3. Turn on SATELLITE and change channels via SATELLITE.

*To watch VCR tape without amp;*

1. Turn on monitor set to channel 4.
2. Turn on VCR play tape.

*To watch VCR tape with amp;*

1. Turn on monitor set to input 1.
2. Turn on AMP set to VCR.
3. Turn on VCR play tape.

*To watch DVD without amp;*

1. Turn on monitor set to channel 4.
2. Turn on DVD play disc.

*To watch DVD with amp;*

1. Turn on monitor set to input 1.
2. Turn on AMP set to DVD.
3. Turn on DVD play disc.

*To listen to CD;*

1. Turn on AMP set to DVD.
2. Turn on DVD play CD.

### 4-16.7.2 Rear A/V System

*To watch cable without amp;*

1. Turn on monitor and change channels via monitor .

*To watch terrestrial antenna without amp;*

1. Turn on monitor and change channels via monitor .

*To watch satellite without amp;*

1. Turn on monitor set to channel 4.
2. Turn on SATELLITE and change channels via SATELLITE.

*To watch cable with amp;*

1. Turn on monitor set to input 2.
2. Turn on AMP set to AUX.
3. Turn on VCR and change channels via VCR.

*To watch terrestrial antenna with amp;*

1. Turn on monitor set to input 2.
2. Turn on AMP set to AUX.
3. Turn on VCR and change channels via VCR.

*To watch satellite with amp;*

1. Turn on monitor set to input 2.
2. Turn on AMP set to AUX.
3. Turn on VCR set to input 1.
4. Turn on SATELLITE and change channels via SATELLITE.

*To watch VCR tape without amp;*

1. Turn on monitor set to channel 4.
2. Turn on VCR play tape.

*To watch VCR tape with amp;*

1. Turn on monitor set to input 1.
2. Turn on AMP set to AUX.
3. Turn on VCR play tape.

*To watch DVD without amp;*

1. Not Available.

*To watch DVD with amp;*

1. Turn on monitor set to input 2.
2. Turn on AMP play DVD.

*To listen to CD;*

1. Turn on AMP play CD.

 **NOTES:**

---

---

---

---

---

---

---

---

---

---

---

---

---

---

---

---

---

---

---

---

---

---

---

---

---

---

---

---

---

---

## 4-17 Electronic Step

### 4-17.1 Description and Operation

The coach is equipped with a single electronic step that automatically extends when motor home door is open and also has a switch just inside the door that enables the step as well.

The control unit is essentially a current sensor as well as a switching device. When the motor assembly moves the step tread moves to its extended position, or stops moving because of an obstruction such as a curb or the binding of a damaged or bent step frame, the motor draws a larger amount of current. The control unit “senses” the larger current draw and shuts off power to the motor.

All control units are equipped with an “ignition override system”. This system is designed so that the coach cannot be driven with the step in the extended position, unless there is faulty wiring in which case, see notes below on how to handle this. When the step is locked in the extended position, the door is closed, and the ignition is turned on, the ignition override system will engage causing the step to automatically retract.

The “Last Out” feature is another safety feature designed to extend the step when the door is opened for the first time after the coach ignition is turned off, even if the power switch is turned off. When the ignition is switched on, the function of the power switch is disabled and the step will always extend when the door is opened and retract when the door is closed.

 **NOTE:** Follow the instructions in this manual carefully. Failure to do so may result in damage to the step control, the motor and/or the coach wiring. Such damage may also result in voiding the warranty.

#### 4-17.1.1 Operating the Step

1. After the installation is complete and with the entrance door open, turn the power switch on.

 **NOTE:** Some steps are not equipped with a power switch. They are activated only with a door switch.

2. Close the door. The step should retract and lock in the “up” position.
3. Open the door. The step should extend and lock in the “down” position with the understep light on.

 **NOTE:** The understep light is not available on all step models.

4. If your step is equipped with a power switch, turn it off. The step should remain in the extended position with the understep light off when the door is closed. Turning off the power with the step retracted will hold the step in a retracted position as well.
5. With the power switch off, the step extended, and the entrance door closed, turn on the coach ignition. The ignition override system will go into effect and the step will automatically retract.
6. Turn the coach ignition off and open the door. The step will extend and lock in the “down” position. This is the “Last Out” feature.
7. The “Last Out” feature is only operative the first time the door is opened after the coach ignition is turned off.

When the coach ignition is on, the step will always activate with the door movement, regardless of the power switch position.

### 4-17.1.1 In case of “Ignition Override System Failure”

 **NOTE:** If the yellow wire from the four-way connector is not connected to an ignition power source, the ignition safety system will be inoperative and the step will remain in the extended position. In this case, the power switch must be turned on for the step to retract.

**WARNING!!** If the coach is driven with the step in the extended position, there is the possibility of causing major damage to both the step and the coach.

### 4-17.1.2 In case of “Last Out Failure”

 **NOTE:** If the yellow wire from the four-way connector is not connected to an ignition power source, the “Last Out” feature will not operate.

**Always remember. . .**

**BE SAFE. ALWAYS LOOK BEFORE YOU STEP OUT OF YOUR COACH. AND ALWAYS CHECK THE STEP BEFORE DRIVING AWAY. A FEW MINUTES NOW CAN SAVE COSTLY REPAIRS LATER ON.**

## 4-17.2 Maintenance and Lubrication

Clean all dust, salt, and road grime from the step before lubricating. Lubricate all moving parts (bearings, pivot points, slides, clevis pin, and drive linkage ball) every 30 days with a good quality moisture and heat resistant penetrating grease. KwikLube™ Spray Grease is specially formulated to lubricate Kwiee Electric Steps and is recommended for lubricating all moving parts. Refer to the figures below for lubrication locations.

**NOTE:** Silicone lubricants and WD-40 are not recommended as they have a tendency to evaporate and dry the mating surfaces, which leave them vulnerable to the elements.

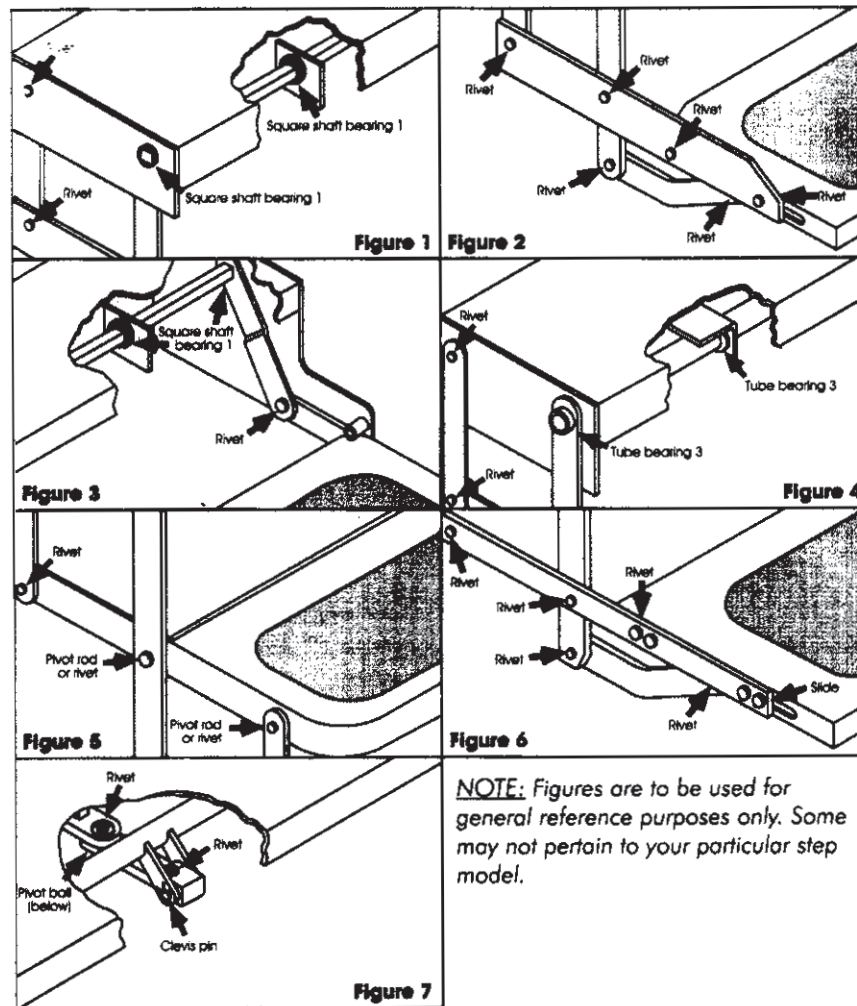

- Figures 1 & 3** – square shaft bearing – lubricate around outside and under head of bearing.
- Figure 4** – on step models equipped with plastic cover, this cover will have to be removed to lubricate center bearings. Lubricate bearings under cover every 90 days.
- Figure 4** – Lubricate around the bushing-in-bushings.
- Maintain clean, dry electrical connections at the two-way and four-way connectors and any butt connections leading from the four-connector to the coach. A small dab of di-electric grease at the connections and replacing corroded butt connections with heat shrink type crimp style automotive connectors will help maintain a good electrical source for the step.



## 4-18 Electronic Shades

### 4-18.1 Automatic Shade Operation

The Spyder Controls Blind Control Module (BCM) is designed to control the motion of the electric window coverings in the coach. The BCM controls the window shades either individually or all at once in one direction. For control of blinds all at once refer to 4-20.1.3 To Operate Shade Switch Panels All At Once section found after section below.

#### 4-18.1.2 Operating Shade Switch Panels

##### Individually

There is a single button to control each window shade (or set of shades) and each button is labeled to indicate the window shade that it operates. For instance, to operate the living room shade use the LvrM Shade button. To operate the shades using the switch panels follow procedure below:

- OPEN - Quick push or "tap" of individual shade button, will move the shade in that area, down.
- STOP - Quick push or "tap" of same button, when shade is moving will stop shade in motion
- CLOSE - prolonged push (1 second) of same button, will move shade up.

**NOTE:** When the shade is activated the control module will run for 15 seconds or unless the shade button is tapped, in this case it will stop. If the shade is half-way down or up the module still runs its 15 second cycle, even if the shade has stopped moving. The reason for this is due to a built in limit switch inside the shade which disables the shade motor unless polarity is reversed. As a result of this, the module may still be running even if the shade has stopped moving.

Usually, if the shade has stopped, and the button is tapped again to resume movement, and nothing happens a quick tap of the button again will start a new 15 second time cycle and shade will then begin to move.

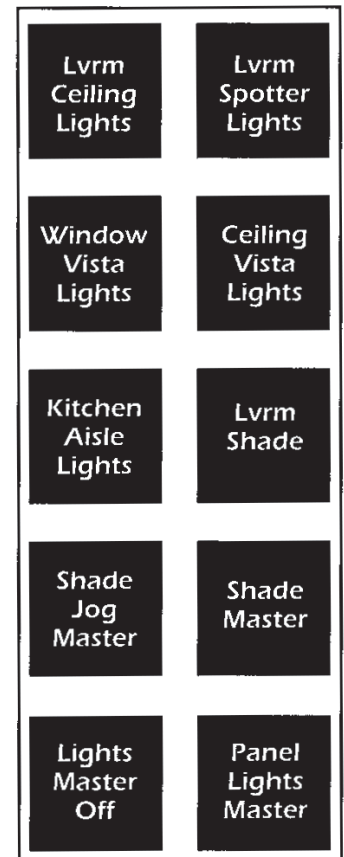

Sample of panel with shade controls. Buttons may vary according to model of coach ordered. Buttons work the same.

#### 4-18.1.3 To Operate Shade Switch Panels All At Once

The Shade Master button allows the shades to simultaneously open or close all at the same time.

- OPEN - Quick push or "tap" of shade master button, moves the shades down all at once.
- STOP - Quick push or "tap" of that same button, will stop all shades in motion.
- CLOSE - prolonged push (1 second) of same button, will move shades up all at once.

#### 4-18.1.4 To Jog Shades to a Certain Position

The Shade Jog Master button allows the shades to be moved down in increments till the desired length of shade. To operate this button, hold down until shade is at desired length. This will move down in increments until the button is released.





## 4-19 Stabilizing System

Your motorhome is equipped with a “Big Foot” Hydraulic Stabilizing System from Quadra Manufacturing, Inc. The Stabilizing System is compact and requires very little bay space which increases your cargo carrying capacity. This system is designed to be used in conjunction with the Hadley Air Leveling system in Section 4-5. The Air Leveling System is the primary leveling system; the hydraulic jacks are designed to stabilize a level coach - each of the four hydraulic jacks extend until it senses the ground. In an emergency situation, the hydraulic jacks can be used to manually level the coach as long as the jacks are operated in pairs as discussed in this Stabilizing Section.

### 4-19.1 Operating Instructions for Automatic Control Panel with Manual Option:

1. Turn Power Switch On



**NOTE:** Immediately upon power initialization the system will enter a 30-second self-diagnostic mode, indicated by the Directional LEDs and the Level Indicator flashing. Upon completion of this mode, one or two Directional LEDs will be lit with one flashing. A lit LED indicates the end and/or side of the vehicle that is low. If the vehicle is in a level position, only the Level Light will flash.

2. Select Auto or Manual Mode by pressing the corresponding touch pad.

If Auto Mode was selected, proceed to *“Automatic Mode”* Step 3.

If Manual Mode was selected, turn to *“Extending Stabilizers Individually”*

#### **AUTOMATIC MODE:**

##### **3. WAIT WHILE WATCHING THE PANEL.**

The system will lower both legs at the lowest end of the vehicle. When the first leg reaches the ground it will cause the system to sense motion and stop. Next, each leg will be lowered individually confirming ground contact by causing the system to sense motion. The system will then repeat the process for the other end of the vehicle.

##### **4. WAIT WHILE WATCHING THE PANEL**

The system will repeat Step 3 for the other end of the vehicle then stabilize the vehicle in all other directions. Completion of this process is indicated by illumination of the Level Light.

#### **4-19.1.1 Retracting Stabilizers while in Automatic Mode**

**IMPORTANT! After the stabilizers are retracted make a visual check to be sure all legs are retracted before moving the unit!**

Determine if the power to the Control Panel was left on or turned off, and proceed as follows:

**If the Control Panel Power Was Turned On:** Press the Retract Pad and release. All legs will automatically retract and cause the All-Up LED to light.

**If the Control Panel Power Was Turned Off:** Turn power on and wait for the system to go through a 30-second self-diagnostic mode, indicated by the Directional LEDs and the Level Indicator flashing. Press the Retract Pad and hold in until all stabilizers are completely retracted as indicated by the All-Up LED being lit.

### 4-19.1.2 Manual Mode or Extending Stabilizers Individually

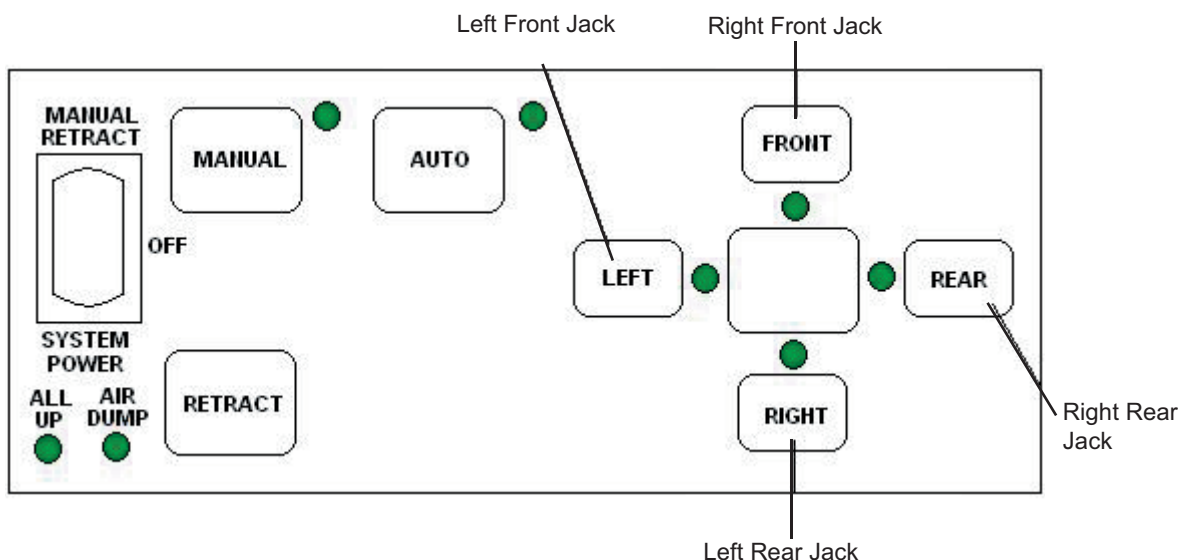

1. Push and hold manual button until indicator light is illuminated indicating system is in manual mode. (See figure above).
2. Press buttons on the four-button side panel individually to extend stabilizers.

**IMPORTANT NOTE:** Make certain to run jacks in pairs by pushing the following button pairs together (see chart below). If the jacks are not operated in pairs, this could twist the body structure and affect slideout room operation by distorting the slideout opening.

Button Pairs	Action
Left & Front	Raises Front
Right & Rear	Raises Rear
Left & Right	Raises Left Side
Front & Rear	Raises Right Side
Left & Front	<b>NO - Twists Body</b>
Rear & Front	<b>NO - Twists Body</b>

### 4-19.1.3 To Operate Manually

To level manually extend two stabilizers at a time by pushing jacks in pairs. For example, either by pushing the front and left together or the right and rear together.

## 4-19.2 Maintenance Guide

One advantage of owning a Big Foot Stabilizing System from Quadra Mfg. is that your system requires very little in the way of maintenance. Here is a guide to follow for years of carefree service.



**NOTE:** Maintenance related problems and maintenance service are not covered by warranty.

### Check the fluid level at least once a year:

- Remove the red fill cap at each stabilizer pump and use a wire-tie as a dipstick (not provided) to check the fluid level. The correct level is  $\frac{3}{4}$ " from the top of the reservoir.
- If needed, fill with Dexron II or III transmission fluid. The standard reservoir holds 54 oz. And the deep reservoir holds 141 oz.

### Under mild to normal weather conditions:

- Extend stabilizers and spray the rams of the hydraulic cylinders with silicone\* spray twice a year. Let the spray dry and retract the stabilizers.

### If you leave your stabilizers extended over a period of time:

- When camping or storing your vehicle for the winter, be sure to spray the rams of the hydraulic cylinders with silicone spray before retracting your stabilizers to avoid tearing the cylinder's seal.

### Under severe weather conditions:

- The above procedure should be followed on a monthly basis if conditions exist that result in your stabilizers being exposed to high amounts of salt, dirt and wind.

### Limit pins:

- Clean with brake cleaner and then spray with clear silicone twice a year.

### Routinely check your footpads:

- The bolt should be tightened with a 15/16 socket or an impact wrench and a 1-1/8" narrow head wrench.
- Torque footpad to 120 lbs. Over time, vibration may work footpads loose.

*\*Use ONLY silicone spray*

## 4-19.3 Troubleshooting

### PANEL:

#### Power On button is pushed but no indicators are lit on panel –

- Fuse on the back of the panel is blown.
- White wire on the four-wire pigtail is not getting constant power.
- Ground wire may not be getting a good ground.
- White or black wire on pigtail may be pushed back in the plug.

#### Vehicle is started and stabilizers are down but the warning alarm does not sound –

- Yellow wire is not getting power when the key is turned forward.
- Yellow wire may be pushed back in the plug.

#### Cylinders will not retract and the red indicator light is not lit –

- Limit pin on the cylinder may be stuck.
- Limit pin wire on the main wire harness may be pushed back in the plug.
- Limit switch ground wire on the tank assembly may not be grounding properly.

#### Cylinders will not extend or retract –

- The 120 amp breaker has been tripped.
- Wires on the tank solenoids have a break or are not making a good connection.

### CYLINDERS:

#### Cylinders do not fully extend or retract –

- Air trapped in the cylinder.
- Hydraulic lines are plumbed backwards.
- There is no fluid or low fluid in the tank reservoir.

#### Cylinder continues to run after the panel button has been released –

- Tank solenoids may be sticking.
- Panel switch may be sticking.

#### Cylinder will not lift or hold the weight of the motor home –

- Lines may be plumbed backwards.
- Back pressure circuit in hydraulic pump is bad
- Damaged piston seal inside cylinder

## 5-1 Caterpillar C-13 Engine

The 450 LXi is equipped with the Caterpillar C-13 Engine. Basic operating instructions are as follows: Maintenance procedures can be found in the [5-3 Engine Maintenance](#) Section of this manual.

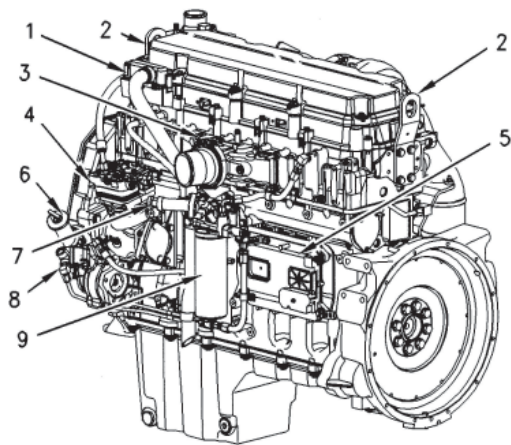

- (1) Engine crankcase breather
- (2) Lifting eyes
- (3) Inlet air manifold
- (4) Air compressor
- (5) Engine control module (ECM)
- (6) Engine oil fill neck
- (7) Fuel priming pump
- (8) Fuel transfer pump
- (9) Fuel filter

- (10) High pressure turbocharger
- (11) Low pressure turbocharger
- (12) Air precooler
- (13) Water temperature regulator
- (14) Spring loaded belt tensioner
- (15) Engine oil filter
- (16) Water pump
- (17) Engine oil pump
- (18) Vibration damper

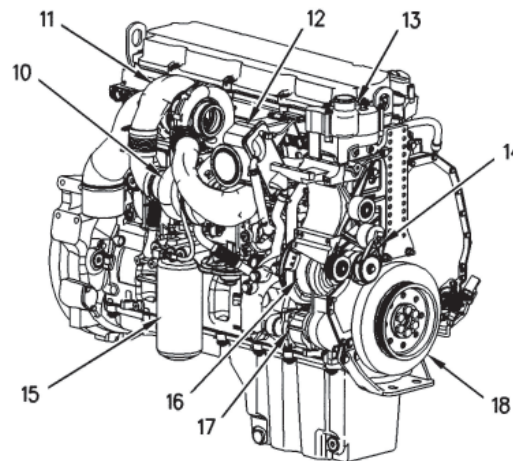

### 5-1.1 General Hazard Information

The following paragraphs cover basic safety, hazard and operating information. In addition, this section identifies hazardous, warning situations. Read and understand the precautions listed in the safety section before operating or performing lubrication, maintenance and repairs on the engine. The operating techniques outlined in this manual are basic. They assist with developing the skills and techniques required to operate the engine more efficiently and economically. Skill and techniques develop as the operator gains knowledge of the engine and its capabilities.

The operation section is a reference for operators. Photographs and illustrations guide the operator through procedures of inspecting, starting, operating and stopping the engine. This section also includes a discussion of electronic diagnostic information. Information on the Engine Messenger System can be found in [Section 5-2 Engine Messenger System](#) of this Owner's Manual.

#### 5-1.1.1 Overhaul

Major engine overhaul details are not covered in the Operation and Maintenance sections of this manual except for the maintenance intervals and the maintenance items in that interval. Major repairs are best left to trained personnel or an authorized Caterpillar dealer. Your Caterpillar dealer offers a variety of options regarding overhaul programs. If you experience a major engine failure, there are also numerous after failure overhaul options available from your Caterpillar dealer. Consult with your dealer for information regarding these options.

### 5-1.1.2 California Proposition 65 Warning

Diesel engine exhaust and some of its constituents are known to the State of California to cause cancer, birth defects, and other reproductive harm.

Battery posts, terminals and related accessories contain lead and lead compounds. **Wash hands after handling.**

## 5-1.2 Safety Section

### 5-1.2.1 Safety Messages

There may be several specific warning stickers on your engine. The exact location and a description of the warning stickers are reviewed in this section. These stickers are on the engine to protect the customer, please become familiar with all warning stickers.

Ensure that all of the warning stickers are legible. Clean the warning stickers or replace the warning stickers if the words cannot be read or if the illustrations are not visible. Use a cloth, water, and soap to clean the warning stickers. Do not use solvents, gasoline, or other harsh chemicals. Solvents, gasoline or harsh chemicals could loosen the adhesive that secures the warning stickers. The warning stickers that are loosened could drop off of the engine.

Replace any warning sticker that is damaged or missing. If a warning sticker is attached to a part of the engine that is replaced, install a new warning sticker on the replacement part. Your Caterpillar dealer can provide new warning stickers.

### 5-1.2.2 Universal Warning

One warning label for the Universal Warning is located on the valve cover base on the left side of the engine. The label is on the fourth flat surface from the rear of the engine.



**Do not operate or work on this equipment unless you have read and understand the instructions and warnings in the Operation and Maintenance Manuals. Failure to follow the instructions or heed the warnings could result in serious injury or death.**

The other warning label for the Universal Warning is located on the vertical surface of the water temperature regulator housing just below the round boss that is cast into the housing.



### 5-1.2.3 General Hazard Information



Attach a “**Do Not Operate**” warning tag or a similar warning tag to the start switch or to the controls before the engine is serviced or before the engine is repaired. These warning tags (Special Instruction, SEHS7332) are available from your Caterpillar dealer. Attach the warning tags to the engine and to each operator control station. When it is appropriate, disconnect the starting controls.

#### **Do not allow unauthorized personnel on the engine or around the engine when the engine is serviced.**

- Tampering with the engine installation or tampering with the OEM supplied wiring can be dangerous. Engine damage, personal injury and/or death could result.
- Vent the engine exhaust to the outside when the engine is operated in an enclosed area.
- If the engine is not running, do not release the secondary brake or the parking brake systems unless the coach is blocked or unless the coach is restrained.
- Wear a hard hat, protective glasses, and other protective equipment, as required.
- When work is performed around an engine that is operating, wear protective devices for ears in order to help prevent damage to hearing.

- Do not wear loose clothing or jewelry that can snag on controls or on other parts of the engine.
- Ensure that all protective guards and covers are secured in place on the engine.
- Never put maintenance fluids into glass containers. Glass containers can break.
- Use all cleaning solutions with care.
- Report all necessary repairs.

**Unless other instructions are provided, perform the maintenance under the following conditions:**

- The engine is stopped.
- The protective locks or the controls are in the applied position.
- Engage the secondary brakes or parking brakes.
- Block the coach or restrain the coach before maintenance or repairs are performed.
- Disconnect the batteries when maintenance is performed or when the electrical system is serviced. Disconnect the battery ground leads. Tape the leads in order to help prevent sparks.
- Disconnect the connector for the unit injector that is located on the valve cover base. This will help prevent personal injury from the high voltage to the unit injectors. Do not come in contact with the unit injector terminals while the engine is operating.
- Do not attempt any repairs or any adjustments to the engine while the engine is operating.
- Do not attempt any repairs if not completely sure how to complete the procedure. Use the proper tools. Replace any equipment that is damaged or repair the equipment.
- For initial start-up of a new engine or for starting an engine that has been serviced, make provisions to stop the engine if an overspeed occurs. This may be accomplished by shutting off the fuel supply and/or the air supply to the engine.
- Start the engine from the operator's station (cab). Never short across the starting motor terminals or the batteries. This could bypass the engine neutral start system and/or the electrical system could be damaged.

#### **5-1.2.4 Pressure Air and Water**

Pressurized air and/or water can cause debris and/or hot water to be blown out. This could result in personal injury. When pressure air is used for cleaning, wear a protective face shield, protective clothing, and protective shoes. The maximum air pressure for cleaning purposes must be below 205 kPa (30 psi). The maximum water pressure for cleaning purposes must be below 275 kPa (40 psi). Always wear eye protection for cleaning the cooling system.

#### **5-1.2.5 Fluid Penetration**

Always use a board or cardboard when the engine components are checked for leaks. Leaking fluid that is under pressure can cause serious injury or possible death. This includes leaks that are the size of a pin hole. If fluid is injected into the skin, seek treatment immediately. Seek treatment from a doctor that is familiar with this type of injury.

#### **5-1.2.6 Fluid Spillage**

Care must be used in order to ensure that the fluids are contained during the inspection, the maintenance, the testing, the adjusting, and the repair of the engine. Make provisions to collect the fluid with a suitable container before any compartment is opened or before any component is disassembled. This publication explains the items that are needed for collecting and for containing fluids that are used in Caterpillar engines. Dispose of fluids according to local regulations.

#### **5-1.2.7 Asbestos Information**

Caterpillar equipment and replacement parts that are shipped from Caterpillar are asbestos free. Caterpillar recommends the use of only genuine Caterpillar replacement parts.

#### **5-1.2.8 Burn Prevention**

Do not touch any part of an operating engine. Allow the engine to cool before any maintenance is performed on the engine. Relieve all pressure in the air system, in the hydraulic system, in the lubrication system, in the fuel system, or in the cooling system before any lines, fittings or related items are disconnected.

### 5-1.2.9 Coolant

When the engine is at operating temperature, the engine coolant is hot. The coolant is also under pressure. The radiator and all lines to the heaters or to the engine contain hot coolant.

Any contact with hot coolant or with steam can cause severe burns. Allow cooling system components to cool before the cooling system is drained.

Check the coolant level after the engine has stopped and the engine has been allowed to cool.

Ensure that the filler cap is cool before removing it. The filler cap must be cool enough to touch with a bare hand. Remove the filler cap slowly in order to relieve pressure.

Cooling system conditioner contains alkali. Alkali can cause personal injury. Do not allow alkali to come in contact with the skin, the eyes, or the mouth.

### 5-1.2.10 Oils

Hot oil and hot lubricating components can cause personal injury. Do not allow hot oil or hot components to contact the skin.

### 5-1.2.11 Batteries

Electrolyte is an acid. Electrolyte can cause personal injury. Do not allow electrolyte to contact the skin or eyes. Always wear protective glasses for servicing batteries. Wash hands after touching the batteries and connectors. Use of gloves is recommended.

### 5-1.2.12 Fire and Explosion Prevention

All fuels, most lubricants, and some coolant mixtures are flammable.

Flammable fluids that are leaking or spilled onto hot surfaces or onto electrical components can cause a fire. Fire may cause personal injury and property damage.

A flash fire may result if the covers for the engine crankcase are removed within fifteen minutes after an emergency shutdown.

Determine whether the engine will be operated in an environment that allows combustible gases to be drawn into the air inlet system. These gases could cause the engine to overspeed. Personal injury, property damage, or engine damage could result.

If the application involves the presence of combustible gases, consult your Caterpillar dealer for additional information about suitable protection devices.

Remove all flammable materials such as fuel, oil, and debris from the engine. Do not allow any flammable materials to accumulate on the engine.

Store fuels and lubricants in properly marked containers away from unauthorized persons. Store oily rags and any flammable materials in protective containers. Do not smoke in areas that are used for storing flammable materials.

Do not expose the engine to any flame.

Exhaust shields (if equipped) protect hot exhaust components from oil or fuel spray in case of a line, a tube, or a seal failure. Exhaust shields must be installed correctly.

Do not weld on lines or tanks that contain flammable fluids. Do not flame cut lines or tanks that contain flammable fluid. Clean any such lines or tanks thoroughly with a nonflammable solvent prior to welding or flame cutting.

Wiring must be kept in good condition. All electrical wires must be properly routed and securely attached. Check all electrical wires daily. Repair any wires that are loose or frayed before you operate the engine. Clean all electrical connections and tighten all electrical connections.

Eliminate all wiring that is unattached or unnecessary. Do not use any wires or cables that are smaller than the recommended gauge. Do not bypass any fuses and/or circuit breakers.

Arcing or sparking could cause a fire. Secure connections, recommended wiring, and properly maintained battery cables will help to prevent arcing or sparking.



Inspect all lines and hoses for wear or for deterioration. The hoses must be properly routed. The lines and hoses must have adequate support and secure clamps. Tighten all connections to the recommended torque. Leaks can cause fires.

Oil filters and fuel filters must be properly installed. The filter housings must be tightened to the proper torque.

Use caution when you are refueling an engine. Do not smoke while you are refueling an engine. Do not refuel an engine near open flames or sparks. Always stop the engine before refueling.

Gases from a battery can explode. Keep any open flames or sparks away from the top of a battery. Do not smoke in battery charging areas.

Never check the battery charge by placing a metal object across the terminal posts. Use a voltmeter or a hydrometer.

Improper jumper cable connections can cause an explosion that can result in injury. Refer to the [Operation](#) Section of this manual for specific instructions.

Do not charge a frozen battery. This may cause an explosion.

The batteries must be kept clean. The covers (if equipped) must be kept on the cells. Use the recommended cables, connections, and battery box covers when the engine is operated.

### 5-1.2.13 Fire Extinguisher

Make sure that a fire extinguisher is available. Be familiar with the operation of the fire extinguisher that is supplied in your coach. Inspect the fire extinguisher and service the fire extinguisher regularly. Obey the recommendations on the instruction plate.

### 5-1.2.14 Ether (if equipped)

Ether is flammable and poisonous.

Use ether in well ventilated areas. Do not smoke while you are replacing an ether cylinder or while you are using an ether spray.

#### WARNING

**DO NOT USE ETHER (starting fluids) unless specifically instructed to do so. If the engine is equipped with an Air Inlet Heater (electrically or fuel ignited manifold heater), DO NOT use ether (starting fluids) at any time. The use could result in engine damage and/or personal injury.**

Do not store ether cylinders in living areas or in the engine compartments.

Do not store ether cylinders in direct sunlight or in temperatures above 49°C (120°F). Keep ether cylinders away from open flames or sparks.

Dispose of used ether cylinders properly. Do not puncture an ether cylinder. Keep ether cylinders away from unauthorized personnel.

Do not spray ether into an engine if the engine is equipped with a thermal starting aid for cold weather starting.

### 5-1.2.15 Lines, Tubes and Hoses

Do not bend high pressure lines. Do not strike high pressure lines. Do not install any lines that are bent or damaged.

Repair any lines that are loose or damaged. Leaks can cause fires. Consult your Caterpillar dealer for repair or for replacement parts.

Check lines, tubes and hoses carefully. Do not use your bare hand to check for leaks. Use a board or cardboard to check for leaks. Tighten all connections to the recommended torque.

Replace the parts if any of the following conditions are present:

- End fittings are damaged or leaking.
- Outer coverings are chafed or cut.
- Wires are exposed.
- Outer coverings are ballooning.
- Flexible part of the hoses are kinked.
- Outer covers have embedded armoring.
- End fittings are displaced.

Make sure that all clamps, guards, and heat shields are installed correctly. During engine operation, this will help to prevent vibration, rubbing against other parts, and excessive heat.

### 5-1.2.16 Crushing and Cutting Prevention

Support the component properly when working beneath the component.

Unless other maintenance instructions are provided, never attempt adjustments while the engine is running.

Stay clear of all rotating and moving parts. Leave the guards in place unless maintenance is being performed. Remove guards prior to performing maintenance. After the maintenance is completed, reinstall the guards.

Keep objects away from moving fan blades. The fan blades will throw or cut objects. Do not attempt to stop a fan by bare hand even though it appears to be moving very slowly. Do not hit a fan blade. Fan blades are made out of plastic and can break immediately, or become unbalanced and fail later on or they can crack or fracture and fail later on.

Chips or other debris may fly off objects when objects are struck. Make sure no one is close enough to be injured by flying debris.



**NOTE:** When working around engine always wear protective glasses to protect against eye injury.

### 5-1.2.17 Mounting and Dismounting

Inspect the stops, the handholds, and the work area before mounting the engine. Keep these items clean and in good repair.

Mount and dismount the engine only at locations that have steps and/or handholds. Do not climb or jump off the engine.

Face the engine in order to mount or dismount the engine. Maintain a three-point contact with the steps and handholds. Use two feet and one hand or use one foot and two hands. Do not use any controls as handholds.

Do not stand on components which cannot support your weight. Use an adequate ladder or use a work platform. Secure the climbing equipment so that the equipment will not move.

Do not carry tools or supplies when you mount or dismount the engine. Use a hand line to raise and lower tools or supplies.

## 5-1.3 Starting the Engine - Safety

### 5-1.3.1 Before Starting Engine

Inspect the engine for potential hazards.

Before starting the engine, ensure that no one is on, underneath, or close to the engine. All protective guards and all protective covers must be installed if the engine must be started in order to perform service procedures. To help prevent an accident that is caused by parts in rotation, work around the parts carefully.

Do not bypass or disable the automatic shut off circuits. The circuits are provided in order to help prevent personal injury and help prevent engine damage.

On the initial start-up of a new engine or an engine that has been serviced, prepare to stop the engine if an overspeed condition occurs. This may be accomplished by shutting off the fuel supply to the engine and/or shutting off the air supply to the engine.

### 5-1.3.2 Engine Starting - Safety

If a warning tag is attached to the engine start switch or to the controls, do not start the engine or move the controls. Also, do not disengage the parking brakes. Consult with the person that attached the warning tag before the engine is started.

All protective guards and covers must be installed if the engine must be started in order to perform service procedures. To help prevent an accident that is caused by parts in rotation, work around the parts carefully.

Start the engine from the operator's station (cab). Never short across the starting motor terminals or the batteries. This could bypass the engine neutral start system and/or the electrical system could be damaged.

Always start the engine according to the procedure that is described in this manual. Knowing the correct procedure will help to prevent major damage to the engine components. Knowing the procedure will also help to prevent personal injury.

To ensure that the jacket water heater (if equipped) and/or the lube oil heater (if equipped) is working properly, check the water temperature gauge and the oil temperature gauge during the heater operation.

Engine exhaust contains products of combustion that can be harmful to your health. Always start the engine and operate the engine in a well ventilated area. If the engine is started in an enclosed area, vent the engine exhaust to the outside.

### 5-1.3.3 Ether (if equipped)

#### WARNING

**DO NOT USE ETHER (starting fluids) unless specifically instructed to do so. If the engine is equipped with an Air Inlet Heater (electrically or fuel ignited manifold heater), DO NOT use ether (starting fluids) at any time. The use could result in engine damage and/or personal injury.**

Ether is poisonous and flammable. Do not inhale ether, and do not allow ether to contact the skin. Personal injury could result. Do not smoke while ether cylinders are changed. Use ether in well ventilated areas.

Keep ether cylinders out of the reach of unauthorized persons. Store ether cylinders in authorized storage areas only. Do not store ether cylinders in direct sunlight or at temperatures above 39 °C (102 °F). Discard the ether cylinders in a safe place. Do not puncture or burn the ether cylinders.

### 5-1.3.4 Engine Stopping

Stop the engine according to the procedure in this manual in order to avoid overheating of the engine and accelerated wear of the engine components.

Use the Emergency Stop Button (if equipped) ONLY in an emergency situation. Do not use the Emergency Stop Button for normal engine stopping. After an emergency stop, DO NOT start the engine until the problem that caused the emergency stop has been corrected.

Stop the engine if an overspeed condition occurs during the initial start-up of a new engine or an engine that has been overhauled. This may be accomplished by shutting off the fuel supply to the engine and/or shutting off the air supply to the engine.

To stop an electronically controlled engine, cut the power to the engine.

### 5-1.3.5 Electrical System

Never disconnect any charging unit circuit or battery circuit cable from the battery when the charging unit is operating. A spark can cause the combustible gases that are produced by some batteries to ignite.

To help prevent sparks from igniting combustible gases that are produced by some batteries, the negative “-” jump start cable should be connected last from the external power source to the negative “-” terminal of the starting motor. If the starting motor is not equipped with a negative “-” terminal, connect the jump start cable to the engine block.

Check the electrical wires daily for wires that are loose or frayed. Tighten all loose electrical wires before the engine is started. Repair all frayed electrical wires before the engine is started. See specific instructions found later in this manual.

### 5-1.3.6 Grounding Practices

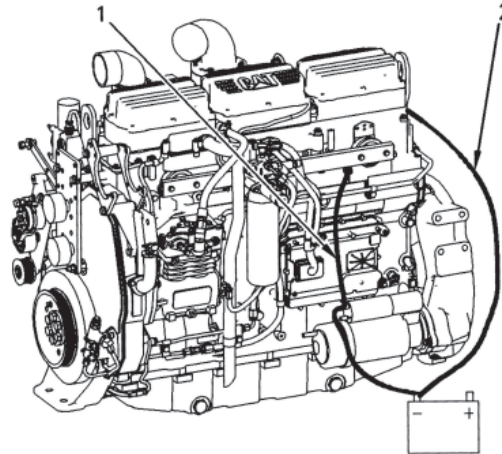

#### Typical Example - Engine Ground

- (1) Recommended Connections
- (2) Alternate Connections

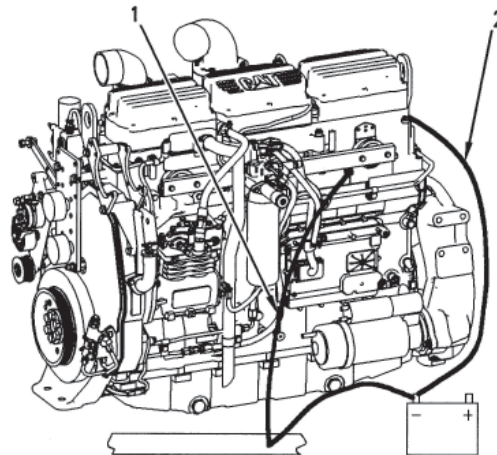

#### Typical Example - Frame Ground

- (1) Recommended Connections
- (2) Alternate Connections

Proper grounding for the engine electrical system is necessary for optimum engine performance and reliability. Improper grounding will result in uncontrolled electrical circuit paths and in unreliable electrical circuit paths.

Uncontrolled electrical circuit paths can result in damage to main bearings, to crankshaft bearing journal surfaces, and to aluminum components.

Engines that are installed without engine-to-frame ground straps can be damaged by electrical discharge.

To ensure that the engine and the engine electrical systems function properly, an engine-to-frame ground strap with a direct path to the battery must be used. This path may be provided by way of a starting motor ground, a starting motor ground to the frame, or a direct engine ground to the frame.

All grounds should be tight and free of corrosion. The engine alternator must be grounded to the negative “-“ battery terminal with a wire that is adequate to handle the full charging current of the alternator.

### 5-1.3.7 Engine Electronics

#### WARNING

**Tampering with the electronic system installation or the OEM wiring installation can be dangerous and could result in personal injury or death and/or engine damage.**

This engine has a comprehensive, programmable Engine Monitoring System. The Engine Control Module (ECM) has the ability to monitor the engine operating conditions. If any of the engine parameters extend outside an allowable range, the ECM will initiate an immediate action.

The following actions are available for engine monitoring control: WARNING, DERATE, and SHUTDOWN. These engine monitoring modes have the ability to limit engine speed and/or the engine power.

Many of the parameters that are monitored by the ECM can be programmed for the engine monitoring functions. The following parameters can be monitored as a part of the Engine Monitoring System.

- Operating Altitude
- Engine Coolant Level
- Engine Coolant Temperature
- Engine Oil Pressure
- Engine Speed
- Fuel Temperature
- Intake Manifold Air Temperature
- System Voltage

The Engine Monitoring package can vary for different engine models and different engine applications. However, the monitoring system and the engine monitoring control will be similar for all engines.



**NOTE:** Many of the engine control systems and display modules that are available for Caterpillar engines will work in unison with the Engine Monitoring System. Together, the two controls will provide the engine monitoring function for the specific engine application.

### 5-1.4 Engine Description

<b>C13 (S/N: KCB) On-highway Engine Specifications</b>	
Cylinders and Arrangement	In-line six cylinder
Bore	130 mm (5.2 inch)
Stroke	157 mm (6.2 inch)
Displacement	12.5 L (763 in <sup>3</sup> )
Firing Order	1-5-3-6-2-4
Rotation (flywheel end)	Counterclockwise

The electronic on-highway engines that are covered by this manual have the following characteristics: direct fuel injection, electronic unit injection that is mechanically actuated, turbocharged, and air-to-air aftercooled (ATAAC).

The electronic engine control system provides the following functions: electronic governing, automatic air to fuel ratio control, torque rise shaping, injection timing control, and system diagnostics.

Several programmable features are included in the electronic control: cruise control, governing the PTO, vehicle speed limiting, rpm limit for high gears, rpm limit for low gears, top engine limit, idle shutdown timer, and control for the engine retarder (compression brake).

Additional benefits provide engine fuel economy, serviceability, and operator comfort. The additional benefits include the following features: improved cold starting capability, resistance to tampering, diagnostics, progressive shift engine speed control, data link (SAE J1587) for the American Trucking Association (ATA), and optional Engine Monitoring Package.

An electronic governor controls the output of the unit injectors in order to maintain the engine rpm that is desired. The functions of the governor include a programmable low idle and a 20 rpm to 200 rpm governor overrun.

Very high injection pressures are produced by electronically controlled, mechanically actuated unit injectors. The injectors combine the pumping and the electronic fuel metering (duration and timing) during injection. The unit injectors accurately control smoke limiting, white smoke, and engine acceleration rates.

Each cylinder has one unit injector. Individual unit injectors meter the fuel. The individual unit injectors also pump the fuel. The metering and the pumping is done under high pressure. High injection pressures help to reduce fuel consumption and emissions. The use of this type of unit injector provides total electronic control of injection timing. The injection timing varies with engine operating conditions. The engine performance is optimized in the following areas:

- Starting
- Emissions
- Noise
- Fuel Consumption
- Driveability

The timing advance is achieved through precise control of the injector firing. Engine speed is controlled by adjusting the firing duration. The information is provided to the Engine Control Module (ECM) by an engine speed/timing sensor. The information is for detection of cylinder position and engine speed.

The engines have built-in diagnostics in order to ensure that all of the components are functioning and operating properly. In the event of a system component deviation from the programmed limits, the operator will be alerted to the condition by a CHECK ENGINE/DIAGNOSTIC lamp that is mounted on the dashboard. An electronic service tool that is provided by Caterpillar or the cruise control switches (if equipped) may be used to read the numerical code of the diagnostic flash code. There are three types of diagnostic codes: ACTIVE, LOGGED, and EVENT. These codes are logged and stored in the ECM. Refer to *“Engine Diagnostics”* section of this manual for additional information.

The cooling system consists of the following items: a centrifugal pump that is driven by a gear, water temperature regulator, an oil cooler, and an OEM supplied radiator that incorporates a shunt system.

The engine lubricating oil is supplied by a gear type pump. The engine lubricating oil is cooled and filtered. Bypass valves provide unrestricted flow of lubrication oil to the engine parts when the oil viscosity is high or if either of the oil cooler or the oil filter elements (paper cartridge) become plugged.

Engine efficiency, efficiency of emission controls, and engine performance depend on adherence to proper operation and maintenance recommendations. This includes the use of recommended fuels, coolants and lubrication oils.

#### 5-1.4.1 Multitorque Rating (If Equipped)

The Multitorque ratings provide additional torque as engine load increases. This feature provides higher torque levels. This feature also provides better driveability while the vehicle is only in the top gears. The engine electronics are able to determine when the vehicle is in the top gears by calculating the engine rpm/vehicle speed ratio.

With the additional torque, the following benefits are provided: less shifting in rolling terrain, less wear on drive line components, more responsive, and better engine performance.

#### 5-1.4.2 Aftermarket Products and Caterpillar Engines



**NOTICE:** In order to maximize fuel system life and prevent premature wear out from abrasive particles in the fuel, a two micron absolute high efficiency fuel filter is required for all Caterpillar Hydraulic Electronic Unit Injectors. Caterpillar High Efficiency Fuel Filters meet these requirements. Consult your Caterpillar dealer for the proper part numbers.

When auxiliary devices, accessories, or consumables (filters, additives, catalysts, etc.) which are made by other manufacturers are used on Caterpillar products, the Caterpillar warranty is not affected simply because of such use.

However, failures that result from the installation or use of other manufacturers' devices, accessories, or consumables are NOT Caterpillar defects. Therefore, the defects are NOT covered under the Caterpillar warranty.

## 5-1.5 Product Identification Information

### 5-1.5.1 Engine Identification

Caterpillar engines are identified with serial numbers, with performance specification numbers, and with arrangement numbers. In some of the cases, modification numbers are used. These numbers are shown on the Serial Number Plate and the Information Plate that are mounted on the engine.

Caterpillar dealers need these numbers in order to determine the components that were included with the engine. This permits accurate identification of replacement part numbers.

### 5-1.5.2 Serial Number Plate

C11 and C13 the Serial Number Plate is located on the left side of the cylinder block near the rear of the engine.

CATERPILLAR®		CAT®	
SERIAL NUMBER		ARRANGEMENT NUMBER	
ENGINE MODEL			
MADE IN U.S.A.		(ALWAYS GIVE ALL NUMBERS)	

CAT®		CORE AR	ENGINE MODEL	
SER. NO.			FACTORY INSTALLED COMPRESSION BRAKE	
MODIFICATION NO.				
AR NO.		PERF SPEC	MAX ALT	M FT
OEM NO.				
FLS		FTS		
RATED	HP	kw AT	RPM	
MAX	HP	kw AT	RPM	
121-0109				

### 5-1.5.3 Information Plate

On C11 and C13 engines the Information Plate is located on the right side of the engine. The information plate is on the front half of the inlet manifold

### 5-1.5.4 Reference Numbers

Information for the following items may be needed to order parts. Locate the information for your engine. Record the information in the appropriate space. Make a copy of this list for your records. Retain this information for further reference.

#### Record for Reference

Chassis Serial Number: \_\_\_\_\_

Engine Model: \_\_\_\_\_

Engine Serial Number: \_\_\_\_\_

Engine Arrangement Number: \_\_\_\_\_

Modification Number: \_\_\_\_\_

Engine Low Idle RPM: \_\_\_\_\_

Engine Full Load RPM: \_\_\_\_\_

Performance Specification Number: \_\_\_\_\_

Engine HP: \_\_\_\_\_

Primary Fuel Filter Number: \_\_\_\_\_

Water Separator Element Number: \_\_\_\_\_

Secondary Fuel Filter Element Number: \_\_\_\_\_

Lubrication Oil Filter Element Number: \_\_\_\_\_

Auxiliary Oil Filter Element Number: \_\_\_\_\_

Supplemental Coolant Additive Maintenance Element Number: (Optional) \_\_\_\_\_

Total Lubrication System Capacity: \_\_\_\_\_

Total Cooling System Capacity: \_\_\_\_\_

Air Cleaner Element Number: \_\_\_\_\_

Fan Drive Belt Number: \_\_\_\_\_

Alternator Belt Number: \_\_\_\_\_

### 5-1.5.5 Emissions Certification Film

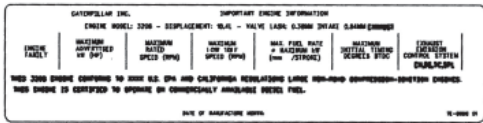

EPA Emissions Certification Film

The EPA Emissions Certification Film (if equipped) and/or the European Emissions Certification Film (if equipped) is located on the side of the engine.

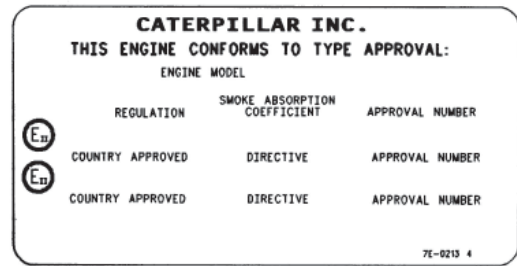

European Emissions Certification Film

### 5-1.5.6 Customer Specified Parameters

To record programmed specifications, use the following chart.

#### Customer Passwords

- “Customer Password #1” \_\_\_\_\_
- “Customer Password #2” \_\_\_\_\_

#### Selected Engine Rating

- “Rating Number” \_\_\_\_\_
- “Rating Type” \_\_\_\_\_
- “Multi-Torque Ratio” \_\_\_\_\_
- “Advertised Power” \_\_\_\_\_
- “Governed Speed” \_\_\_\_\_
- “Rated Peak Torque” \_\_\_\_\_
- “Top Engine Speed” \_\_\_\_\_
- “Test Spec” \_\_\_\_\_
- “Test Spec with Brake Saver” \_\_\_\_\_

#### ECM Identification Parameters

- “Vehicle ID” \_\_\_\_\_
- “Engine Serial Number” \_\_\_\_\_
- “ECM Serial Number” \_\_\_\_\_
- “Personality Part Number” \_\_\_\_\_
- “Personality Module Release Date” \_\_\_\_\_

#### Security Parameters

- “Total Tattletale” \_\_\_\_\_
- “Last Tool to Change Customer Parameters” \_\_\_\_\_
- “Last Tool to Change System Parameters” \_\_\_\_\_
- “ECM Wireless Communications Enable” \_\_\_\_\_



**Customer Specified Parameters - Continued****Vehicle Speed Parameters**

- “Vehicle Speed Calibration” \_\_\_\_\_ pulses per km or pulses per mile
- “Vehicle Speed Limit” \_\_\_\_\_ km per hr or miles per hr
- “Vehicle Speed Limit Protection” \_\_\_\_\_
- “Tachometer Calibration” \_\_\_\_\_ pulses per revolution
- “Soft Vehicle Speed Limit” \_\_\_\_\_
- “Low Speed Range Axle Ratio” \_\_\_\_\_
- “High Speed Range Axle Ratio” \_\_\_\_\_
- “Vehicle Speed Cal (J1939-Trans)” \_\_\_\_\_
- “Vehicle Speed Cal (J1939-ABS)” \_\_\_\_\_

**Cruise Control Parameters**

- “Low Cruise Control Speed Set Limit” \_\_\_\_\_ km per hr or miles per hr
- “High Cruise Control Speed Set Limit” \_\_\_\_\_ km per hr or miles per hr
- “Engine Retarder MODE” \_\_\_\_\_
- “Engine Retarder Minimum VSL Type” \_\_\_\_\_
- “Engine Retarder Minimum Vehicle Speed” \_\_\_\_\_
- “Auto Retarder in Cruise” \_\_\_\_\_
- “Auto Retarder in Cruise Increment” \_\_\_\_\_
- “Cruise/Idle/PTO Switch Configuration” \_\_\_\_\_
- “Soft Cruise Control” \_\_\_\_\_
- “Adaptive Cruise Control Enable” \_\_\_\_\_

**Idle Parameters**

- “Idle Vehicle Speed Limit” \_\_\_\_\_ km per hr or miles per hr
- “Idle RPM Limit” \_\_\_\_\_
- “Idle/PTO Engine Speed Ramp Rate” \_\_\_\_\_ rpm/sec
- “Idle/PTO Bump RPM” \_\_\_\_\_

**PTO Parameters**

- “PTO Configuration” \_\_\_\_\_
- “PTO Top Engine Limit” \_\_\_\_\_
- “PTO Engine RPM Set Speed” \_\_\_\_\_

**Customer Specified Parameters - Continued**

- “PTO to Set Speed” \_\_\_\_\_
- “PTO Cab Controls RPM Limit” \_\_\_\_\_
- “PTO Kickout Vehicle Speed Limit” \_\_\_\_\_
- “Torque Limit” \_\_\_\_\_ N•m or lb ft
- “PTO Shutdown Time” \_\_\_\_\_
- “PTO Activation of Cooling Fan (If Equipped)” \_\_\_\_\_
- “PTO Engine RPM Set Speed” \_\_\_\_\_
- “PTO Engine RPM Set Speed A” \_\_\_\_\_
- “PTO Engine RPM Set Speed B” \_\_\_\_\_
- “Maximum PTO Enable Speed” \_\_\_\_\_
- “PTO Shutdown Timer Maximum RPM” \_\_\_\_\_

**“Engine/Gear Parameters”**

- “Lower Gears Engine RPM Limit” \_\_\_\_\_
- “Lower Gears Turn Off Speed” \_\_\_\_\_ km per hr or miles per hr
- “Intermediate Gears Engine RPM Limit” \_\_\_\_\_
- “Intermediate Gears Turn Off Speed” \_\_\_\_\_ km per hr or miles per hr
- “Gear Down Protection RPM Limit” \_\_\_\_\_
- “Gear Down Protection Turn On Speed” \_\_\_\_\_ km per hr or miles per hr
- “Top Engine Limit” \_\_\_\_\_
- “Top Engine Limit with Droop” \_\_\_\_\_
- “Low Idle Engine RPM” \_\_\_\_\_
- “Transmission Style” \_\_\_\_\_
- “Eaton Top 2 Override with Cruise Switch” \_\_\_\_\_
- “Top Gear Ratio” \_\_\_\_\_
- “Top Gear Minus One Ratio” \_\_\_\_\_
- “Top Gear Minus Two Ratio” \_\_\_\_\_
- “Governor Type” \_\_\_\_\_

**Smart Idle Parameters**

- “Battery Monitor and Engine Control Voltage” \_\_\_\_\_

**Customer Specified Parameters - Continued****Timer Parameters**

- “Idle Shutdown Time” \_\_\_\_\_
- “Idle Shutdown Timer Maximum RPM” \_\_\_\_\_
- “Idle Shutdown Override Allowance” \_\_\_\_\_
- “Minimum Idle Shutdown Outside Temp” \_\_\_\_\_
- “Maximum Idle Shutdown Outside Temp” \_\_\_\_\_
- “A/C Pressure Switch Fan On - Time (If Equipped)” \_\_\_\_\_
- “Fan with Engine Retarder in High Mode (If Equipped)” \_\_\_\_\_
- “Engine Retarder Delay” \_\_\_\_\_

**Engine Monitoring Mode**

- “Warning” \_\_\_\_\_
- “Warning/Derate” \_\_\_\_\_
- “Warning/Derate/Shutdown” \_\_\_\_\_
- “Engine Monitoring Lamps” \_\_\_\_\_
- “Coolant Level Sensor Type” (If Equipped) \_\_\_\_\_
- “Coolant Temperature Derate” \_\_\_\_\_

**Maintenance Indicator Parameters**

- “Maintenance Indicator Mode” \_\_\_\_\_
- “PM 1 Interval” \_\_\_\_\_
- “Engine Oil Capacity” \_\_\_\_\_

**Dash Display Access Parameters**

- “Fuel Correction Factors” \_\_\_\_\_
- “Dash - Change Fuel Correction Factor” \_\_\_\_\_
- “Dash - PM1 Reset” \_\_\_\_\_
- “Dash - Fleet Trip Reset” \_\_\_\_\_
- “Dash - State Selection” \_\_\_\_\_
- “Theft Deterrent System Control” \_\_\_\_\_
- “Theft Deterrent Password” \_\_\_\_\_
- “Quick Stop Rate” \_\_\_\_\_
- “Vehicle Overspeed Threshold” \_\_\_\_\_

**Customer Specified Parameters - Continued****Vehicle Activity Report**

- “Minimum Idle Time” \_\_\_\_\_

**Driver Reward**

- “Driver Reward Enable” \_\_\_\_\_

**Data Link Parameters**

- “Powertrain Data Link” \_\_\_\_\_

**5-1.6 Operation****5-1.6.1 Engine Lifting**

**NOTICE:** Never bend the eyebolts and the brackets. Only load the eyebolts and the brackets under tension. Remember that the capacity of an eyebolt is less as the angle between the supporting members and the object becomes less than 90 degrees.

When it is necessary to remove a component at an angle, only use a link bracket that is properly rated for the weight.

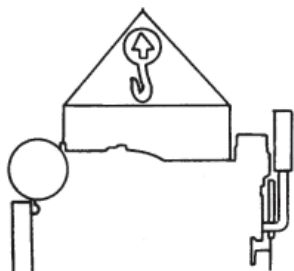

Use a hoist to remove heavy components. Use an adjustable lifting beam to lift the engine. All supporting members (chains and cables) should be parallel to each other. The chains and cables should be perpendicular to the top of the object that is being lifted.

Some removals require lifting the fixtures in order to obtain proper balance and safety.

To remove the engine **ONLY**, use the lifting eyes that are on the engine. If the lifting eyes are missing, consult a Caterpillar dealer for the proper lifting eyes and bolts.

Lifting eyes are designed for the specific engine arrangement. These lifting eyes are installed when the engine is manufactured. Alterations to the lifting eyes and/or the engine make the lifting eyes and the lifting fixtures obsolete. If alterations are made, ensure that proper lifting devices are provided. Consult your Caterpillar dealer for information regarding fixtures for proper engine lifting.

**5-1.6.2 Engine Storage**

If the engine will not be started for several weeks, the lubricating oil will drain from the cylinder walls and from the piston rings. Rust can form on the cylinder liner surface. Rust on the cylinder liner surface will cause increased engine wear and a reduction in engine service life.

To help prevent excessive engine wear, use the following guidelines:

- Complete all of the lubrication recommendations that are listed in the “[Maintenance Interval Schedule](#)” (Maintenance Section) of this manual.
- If freezing temperatures are expected, check the cooling system for adequate protection against freezing. See the “[General Coolant Information](#)” found in this manual for more information.

If an engine is out of operation and if use of the engine is not planned, special precautions should be made. If the engine will be stored for more than one month, a complete protection procedure is recommended.

Your Caterpillar dealer can assist in preparing the engine for extended storage periods.

### 5-1.6.3 Gauges and Indicators

The engine may not have the same gauges or all of the gauges that are described. For descriptions of the gauges that are supplied with this engine, see [2\\_1 Dash and Monitors](#) section found earlier in this manual.

Gauges provide indications of engine performance. Ensure that the gauges are in good working order. Determine the normal operating range by observing the gauges over a period of time.

Noticeable changes in gauge readings indicate potential gauge or engine problems. Problems may also be indicated by gauge readings that change even if the readings are within specifications. Determine the cause of any significant change in the readings. Then, correct any cause of any significant change in the readings. Consult your Caterpillar dealer for assistance.

Electronically controlled engines require one lamp in addition to the gauge package that is normally provided.

The “Diagnostic” lamp is yellow or amber. The “Diagnostic” lamp will communicate the status of the engine’s electronic system.

An optional “Warning” lamp is available. This red “Warning” lamp warns the operator of engine problems.

The following conditions are some examples of the problems:

- Low oil pressure
- High coolant temperature
- Low coolant level
- High inlet air temperature

 **Engine Oil Pressure** - Typical oil pressure for an engine at rated speed with SAE 10W30 or with SAE 15W40 is 207 to 310 kPa (30 to 45 psi) for the C-10 and the C-12. Typical oil pressure for an engine at rated speed with SAE 10W30 or with SAE 15W40 is 276 to 606 kPa (40 to 88 psi) for the 3406E, C-15, and C-16.

A higher oil pressure is normal with cold oil when the engine is started. A lower oil pressure is normal at low idle. If the load is stable and the gauge reading changes, perform the following procedure:

1. Remove the load.
2. Reduce engine speed at low idle.
3. Check the oil level. Maintain the oil level at the proper amount.

The diagnostic lamp will turn on if the oil pressure drops below 35 kPa (5 psi) at low idle rpm. The diagnostic code will be logged in the Engine Control Module (ECM).

 **Engine Oil Temperature** - This gauge indicates the engine oil temperature. An oil temperature that is higher than normal indicates a heat problem in the lubrication system and/or the cooling system. This problem can damage the cylinder heads, the cylinder liners, the pistons, and the crankshaft bearings.

 **Jacket Water Coolant Temperature** - Typical temperature range is 87 to 98 °C (189 to 208 °F). The maximum allowable temperature with the pressurized cooling system is 102 °C (216 °F) for the C-10 and the C-12, for C-13 104 °C (220 °F).

The maximum allowable temperature with the pressurized cooling system is 107 °C (225 °F) for the 3406E, C-15, and C-16. Higher temperatures may occur under certain conditions. The water temperature reading may vary according to load. The reading should never exceed the boiling point for the pressurized system that is being used.

If the engine is operating above the normal range and steam becomes apparent, perform the following procedure:

1. Reduce the load and the engine rpm.
2. Inspect the cooling system for leaks.
3. Determine if the engine must be shut down immediately or if the engine can be cooled by reducing the load.



**NOTICE:** Do not exceed 2300 rpm in any situation or 2100 rpm if equipped with an auxiliary engine brake system.



**Tachometer** - This gauge indicates engine speed. The engine can be operated at high idle without damage, but the engine should not be allowed to overspeed. The engine can overspeed by downshifting or by going downhill. An overspeed can result in serious damage to the engine.



**NOTE:** The high idle rpm and the full load rpm are stamped on the Information Plate.



**Ammeter** - This gauge indicates the amount of charge or discharge in the battery charging circuit. Operation of the indicator should be to the right side of “0” (zero). The charging system should be checked for a malfunction if the indicator is constantly to the left side of “0” (zero) or if the indicator shows an excessive charge during normal operation. Correct any problems.



**Service Hour Meter** - This gauge indicates the total number of clock hours that the engine has operated. Hours of operation are logged in the ECM. A service tool is needed to retrieve the hours from the ECM. A Service Hour Meter may be installed on the engine.



**Fuel Pressure** - This gauge indicates fuel pressure to the electronic unit injectors from the fuel filter. The indicator should indicate the “NORMAL” range. A decrease in fuel pressure usually indicates a plugged fuel filter.



**Fuel Level** - This gauge indicates the level of fuel in the fuel tank. The fuel level gauge registers the fuel level only when the ignition switch is in the ON position.

## 5-1.7 Features and Controls

### 5-1.7.1 Monitoring System

#### **WARNING!!**

**If the Shutdown mode has been selected and the warning indicator activates, engine shutdown may take as little as 20 seconds from the time the warning indicator is activated. Depending on the application, special precautions should be taken to avoid personal injury. The engine can be restarted following shutdown for emergency maneuvers, if necessary.**



**NOTICE:** The Engine Monitoring System is not a guarantee against catastrophic failures. Programmed delays and moderate schedules are designed to minimize false alarms and provide time for the operator to stop the engine.

Programmable features monitor the following conditions:

- Coolant temperature
- Oil pressure
- Inlet manifold air temperature
- Cooling system level (if equipped)

### 5-1.7.2 Coolant Level Sensor (If Equipped)



**NOTICE:** The coolant level sensor is an optional feature.

*The system can be programmed with one of the following options:*

**ENABLED** - The system will monitor the input from the coolant level sensor. The system is programmed to this value when the engine is shipped by Caterpillar.

**DISABLED** - The system will not monitor the input from the coolant level sensor.

### 5-1.7.3 Programmable Options and Systems Operation

#### **WARNING!!**

**If the Warning/Derate/Shutdown mode has been selected and the warning indicator activates, bring the engine to a stop whenever possible. Depending on the application, special precautions should be taken to avoid personal injury.**

The engine can be programmed to the following modes:

- “OFF”
- “Warning”
- “Warning/Derate”
- “Warning/Derate/Shutdown”

#### **“Warning”**

The “DIAGNOSTIC” lamp and the warning signal (red lamp or buzzer) turn “ON” and the warning signal is activated continuously in order to alert the operator that one or more of the engine parameters is not within normal operating range.

#### **“Warning/Derate”**

The “DIAGNOSTIC” lamp turns “ON” and the warning signal (red lamp or buzzer) is activated. After the warning, the engine will derate rpm and power. The warning lamp will begin to flash when the derating occurs.

When the engine is fully derated, the engine power is limited to 120 kW (160 hp). During a low oil pressure condition, the engine can be limited to 1350 rpm.

#### **“Warning/Derate/Shutdown”**

The “DIAGNOSTIC” lamp turns “ON” and the warning signal (red lamp or buzzer) is activated. After the warning, the engine will derate rpm and power. The engine will continue to derate rpm until a shutdown of the engine occurs. The engine can be restarted after a shutdown for use in an emergency.

A shutdown of the engine may occur in as little as 20 seconds. The engine can be restarted after a shutdown for use in an emergency. However, the cause of the initial shutdown may still exist. The engine may shut down again in as little as 20 seconds.

If there is a signal for coolant loss, there will be a 10 second delay in order to verify the condition. The system will derate the engine rpm for 40 seconds before the engine will shut down if the engine has been programmed to shut down.

If there is a signal for low oil pressure or for coolant temperature, there will be a two second delay in order to verify the condition. The system will derate the engine rpm for 30 seconds before the engine will shut down if the engine has been programmed to shutdown.

For more information or assistance for repairs, consult your Caterpillar dealer.



**NOTE:** The Customer Specified Parameters may be secured by customer passwords. The engine may have all of the parameters that are programmed or any combination of the parameters that are programmed. Refer to [“Customer Specified Parameters”](#) section in this manual for more information on the programmed parameters of the engine. Refer to the [Electronic Troubleshooting](#) for more information.

### 5-1.7.4 Cold Start Strategy

These engines use a cold start strategy that limits power until the coolant temperature reaches 28°C (82°F). This cold start strategy is called cold mode. The electronic system will automatically idle the C13 engine at 800 RPM. Cold mode will also vary the fuel injection amount, the timing for the maximum start-up, and the timing for the control of white smoke. Cold mode will provide reduced emissions and reduced warm-up times. Cold mode will be disabled and the engine rpm will drop to the programmed low idle speed if the throttle, the service brake, or the clutch is depressed.

The engine should be operated at low rpm and low power demand until the engine reaches normal operating temperature. The engine will reach normal operating temperature faster when the engine is operated at low rpm and low power demand instead of idling the engine until the engine reaches normal operating temperature.



**NOTICE:** A coach should not be moved until it is out of the cold mode. If the coach is operated while in cold mode, power will be noticeably reduced.

## 5-1.8 Engine Diagnostics

### 5-1.8.1 Self-Diagnostics

Caterpillar Electronic Engines have the capability to perform a self-diagnostics test. When the system detects an active problem, the “DIAGNOSTIC” lamp is activated. Diagnostic codes will be stored in permanent memory in the Electronic Control Module (ECM). The diagnostic codes can be retrieved by using the following components:

- Caterpillar electronic service tools
- “DIAGNOSTIC” lamp



**NOTICE:** The “DIAGNOSTIC” lamp must be installed by the OEM or by the customer.

Some installations have electronic displays that provide direct readouts of the engine diagnostic codes.

Active codes represent problems that currently exist. These problems should be investigated first. If a code is active, the “DIAGNOSTIC” lamp will flash the flash code at five second intervals.

Logged codes represent the following items:

- Intermittent problems
- Recorded events
- Performance history

The problems may have been repaired since the logging of the code. These codes do not indicate that a repair is needed. The codes are guides or signals when a situation exists. Codes may be helpful to troubleshoot problems.

When the problems have been corrected, the corresponding logged fault codes should be cleared.

### 5-1.8.2 Diagnostic Lamp

The “DIAGNOSTIC” lamp is used to indicate the existence of a fault by flashing codes. The “DIAGNOSTIC” lamp that is on the dashboard is usually “YELLOW”.

When the ignition switch is first turned on, the “DIAGNOSTIC” lamp will go through the following procedure:

1. The “DIAGNOSTIC” lamp will illuminate for five seconds.
2. The “DIAGNOSTIC” lamp will turn off.

Whenever the Engine Control Module (ECM) detects an active fault or condition the lamp will flash at five second intervals. If the lamp turns on and if the lamp stays on after initial start-up, the ECM has detected a system problem.

The “DIAGNOSTIC” lamp is also used for the Idle Shutdown Timer. The lamp will start to flash at a rapid rate 90 seconds before the programmed idle time expires. The engine will shut down after the 90 second interval. To disable the Idle Shutdown Timer, the “ALLOW IDLE SHUTDOWN OVERRIDE” must be programmed to “YES”. The clutch pedal or the service brake pedal must be depressed during the final 90 seconds while the “YELLOW” lamp is flashing. A diagnostic “EVENT” code or Override of the Idle Shutdown Timer will be logged in the ECM.



## 5-1.9 Diagnostic Flash Code Retrieval

### 5-1.9.1 “Diagnostic” Lamp

Use the “DIAGNOSTIC” Lamp or a Caterpillar electronic service tool to determine the diagnostic flash code.

Use the following procedure to retrieve the diagnostic codes if the engine is equipped with a “DIAGNOSTIC” lamp:

1. Turn the cruise control ON/OFF switch to the OFF position.
2. Move the SET/RESUME switch to either position. Hold that position until the “YELLOW” lamp begins to flash.

The “YELLOW” lamp will flash in order to indicate a two digit flash code and the SET/RESUME switch may be released. The sequence of flashes represents the system diagnostic message. Count the first sequence of flashes in order to determine the first digit of the diagnostic code. After a two second pause, the second sequence of flashes will identify the second digit of the diagnostic code.

Any additional diagnostic codes will follow after a pause. The additional diagnostic codes will be displayed in the same manner. Flash Code 55 signals that No Detected Faults have occurred since the ignition key switch has been turned to the ON position.

The electronic diagnostic codes are listed and described in the following Diagnostic Flash Code Chart Table.



**NOTE:** Diagnostic Flash Code Chart indicates the potential effect on engine performance with “ACTIVE” flash codes.

Some codes record events or some codes indicate that a mechanical system needs attention rather than indicating a performance problem. Troubleshooting is not required for codes “35”, “41”, “47” and “55”. Code “01” will not flash. Some codes will limit the operation or the performance of the engine.

The Diagnostic Flash Code Chart indicates the potential effect on the engine performance with active flash codes. This table also forms a list of Electronic diagnostic codes and descriptions.

Diagnostic Flash Code or Engine Performance Relationship								
Diagnostic Flash Code		Effect on Engine Performance <sup>(1)</sup>				Suggested Action of the Operator		
		Engine Misfire	Low Power	Reduced Engine Speed	Engine Shutdown	Shut Down the Engine <sup>(2)</sup>	Service <sup>(3)</sup>	Schedule for Service ASAP <sup>(4)</sup>
01	Idle Shutdown Override							
12	Coolant Level Sensor Fault <sup>(5)</sup>							X
13	Fuel Temperature Sensor Fault							X
14	Retarder Solenoid Fault							X
21	Sensor Supply Voltage Fault <sup>(5)(6)</sup>		X					X
24	Oil Pressure Sensor Fault <sup>(5)</sup>							X
25	Boost Pressure Sensor Fault <sup>(6)</sup>		X					X
26	Barametric Pressure Sensor Fault <sup>(6)</sup>							X
27	Coolant Temperature Sensor Fault <sup>(5)(6)</sup>							X
28	Accelerator Pedal Position Out of Calibration							X
29	PTO Throttle Position Sensor Fault			X			X	
31	Loss of Wheel-Based Vehicle Speed Signal			X				X
32	Accelerator Pedal Position Invalid			X			X	
34	Engine RPM Signal Fault	X		X	X		X	
35	Engine Overspeed Warning							
36	Wheel-Based Vehicle Speed Signal Fault			X				X
38	Intake ManifoldAir Temperature Sensor Fault <sup>(5)(6)</sup>							X

## Diagnostic Flash Code or Engine Performance Relationship - Continued

Diagnostic Flash Code		Effect on Engine Performance <sup>(1)</sup>				Suggested Action of the Operator		
		Engine Misfire	Low Power	Reduced Engine Speed	Engine Shutdown	Shut Down the Engine <sup>(2)</sup>	Service <sup>(3)</sup>	Schedule for Service ASAP <sup>(4)</sup>
41	Wheel-Based Vehicle Overspeed Warning							
42	Check Engine Speed Sensor Calibrations		X					X
46	Low Oil Pressure Warning		X	X	X	X	X	
47	Idle or PTO Shutdown Occurrence				X			
51	Intermittent Battery Power to ECM	X	X		X		X	
55	No Detected Faults							
56	Check Customer or System Parameters		X	X				X
	Check Transmission Customer Parameters							
59	Incorrect Engine Software							X
61	High Coolant Temperature Warning		X		X		X	
62	Low Coolant Level Warning		X		X		X	
64	High Intake Manifold Air Temperature Warning							X
65	High Fuel Temperature Warning							X
66	Auxiliary Output #6 Fault							X
67	Auxiliary Output #7 Fault							X
68	Transmission Not Responding							X
69	Malfunction No. 1 Output Fault							X
71	Ignition Key Switch Fault							X
72	Cylinder 1 or 2 Fault	X	X				X	
73	Cylinder 3 or 4 Fault	X	X				X	
74	Cylinder 5 to 6 Fault	X	X				X	
92	Intake Valve Actuator 1 or 2 Fault						X	
93	Intake Valve Actuator 3 or 4 Fault						X	
94	Intake Valve Actuator 5 or 6 Fault						X	
95	Intake Valve Actuation Oil Pressure Voltage Fault							X
97	Intake Valve Actuation System Oil Pressure Solenoid Current Fault							X
98	Engine Coolant Diverter Solenoid Fault							X

(1) An "X" indicates that the effect on engine performance may occur, if the code is active. This depends on the exact failure.

(2) Shut Down the Engine: Operate the engine cautiously. Get immediate service. Severe engine damage may result.

(3) Service: The operator should go to the nearest qualified service facility.

(4) Schedule Service: When it is convenient for the operator, the problem should be investigated.

(5) When the diagnostic flash code is active, the effectiveness of the Engine Monitoring feature is reduced.

(6) The system may be affected by these Diagnostic Flash Codes, only under specific environmental conditions. This includes engine start-up at cold temperature, cold weather operation at high altitudes, etc.

For further information or assistance for repair, consult an authorized Caterpillar dealer

## 5-1.10 ECM Snapshot

The ECM can record a snapshot of the engine parameters and vehicle parameters. The snapshot records the parameters for a period of 13 seconds that surrounds the event, 9 seconds before the trigger and 4 seconds after the trigger. A technician can use a service tool in order to view this snapshot information.

### 5-1.10.1 Triggering Snapshot Information

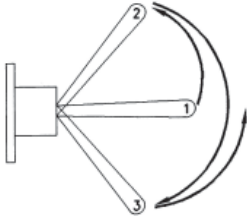

An operator can aid in the troubleshooting of intermittent problems by taking a “snapshot” when the problem is experienced. A snapshot can be triggered by using the Cruise Control Set/Resume Switch. Use the following procedure in order to perform this function:

1. Toggle the switch quickly from the OFF position (1) to the SET position (2).
2. Toggle the switch quickly from the SET position (2) to the RESUME position (3).
3. Toggle the switch quickly from the RESUME position (3) back to the OFF position (1).



**NOTE:** The switch must be toggled within a one second time period in order to take a snapshot of the engine parameters. The procedure can also be performed in the reverse order.

### 5-1.10.2 Storage of Snapshots in the ECM

The ECM can store a maximum of four snapshots that are triggered manually. The newest snapshot will replace the oldest snapshot if a fifth snapshot that is triggered manually is taken.

Snapshots are automatically cleared by the ECM after 100 hours of operation. Also, the snapshots can be cleared manually by using an Electronic Service Tool.

### 5-1.10.3 Fault Logging

The system provides the capability of Fault Logging. When the Electronic Control Module (ECM) generates an active diagnostic code, the code will be logged in the memory of the ECM. The codes that have been logged in the memory of the ECM can be retrieved with Caterpillar electronic service tools. The codes that have been logged can be cleared with Caterpillar electronic service tools. The codes that have been logged in the memory of the ECM will be automatically cleared from the memory after 100 hours. The following faults can not be cleared from the memory of the ECM without using a factory password: overspeed, low engine oil pressure, and high engine coolant temperature.

## 5-1.11 Engine Operation with Active Diagnostic Codes

If the diagnostic lamp stays on during normal engine operation, the system has identified a situation that is not within the specification. Use Caterpillar electronic service tools to check the active diagnostic codes.



**NOTE:** If the customer has selected “DERATE” and if there is a low oil pressure condition, the Electronic Control Module (ECM) will limit the engine power until the problem is corrected. If the oil pressure is within the normal range, the engine may be operated at the rated speed and load. However, maintenance should be performed as soon as possible. Refer to “[Diagnostic Flash Code Retrieval](#)” section in this manual for more information on flash codes.

The active diagnostic code should be investigated. The cause of the problem should be corrected as soon as possible. If the cause of the active diagnostic code is repaired and there is only one active diagnostic code, the diagnostic lamp will turn off.

Operation of the engine and performance of the engine can be limited as a result of the active diagnostic code that is generated. Acceleration rates may be significantly slower. Refer to this manual for more information on the relationship between these active diagnostic codes and engine performance.

### 5-1.11.1 Engine Operation with Intermittent Diagnostic Codes

If the diagnostic lamp illuminates during normal engine operation and the diagnostic lamp shuts off, an intermittent fault may have occurred. If a fault has occurred, the fault will be logged into the memory of the Electronic Control Module (ECM).

In most cases, it is not necessary to stop the engine because of an intermittent code. However, the operator should retrieve the logged fault codes and the operator should reference the appropriate information in order to identify the nature of the event. The operator should log any observation that could have caused the lamp to light.

- Low power
- Limits of the engine speed
- Excessive smoke, etc.

This information can be useful to help troubleshoot the situation. The information can also be used for future reference. For more information on diagnostic codes, refer to [Troubleshooting Guide](#) for this engine.

### 5-1.11.2 Customer Specified Parameters

Customer specified parameters that will enhance the fuel efficiency and the operator's convenience can be programmed into the Electronic Control Module (ECM). Some parameters may affect engine operation. This may lead to complaints from the operator about power or about performance. Certain engine parameters may be programmed by the customer by using Caterpillar electronic service tools in order to influence the operation of the engine:

The customer specified parameters can be changed as often as needed. Password protection is provided so that the customer can change the parameters. The customer can authorize someone else to change the parameters. Ensure that a record of the parameters is kept in this manual in the "[Customer Specified Parameters](#)" section. For detailed instructions on programming the engine for optimum performance and for optimum fuel economy, consult your Caterpillar dealer.

## 5-1.12 Engine Starting

**WARNING!!**

**Engine exhaust contains products of combustion which may be harmful to your health. Always start and operate the engine in a well ventilated area and, if in an enclosed area, vent the exhaust to the outside.**

### 5-1.12.1 Under-the-Hood Inspection

Perform the required daily maintenance and other periodic maintenance before the engine is started. Inspect the engine compartment. This inspection can help prevent major repairs at a later date. Refer to the "[Walk-Around Inspection](#)" section in this manual for more information.

- For the maximum service life of the engine, make a thorough inspection before starting the engine. Look for the following items: oil leaks, coolant leaks, loose bolts, and trash buildup. Remove trash buildup and arrange for repairs, as needed.
- Inspect the cooling system hoses for cracks and for loose clamps.
- Inspect the alternator and accessory drive belts for cracks, breaks, and other damage.
- Inspect the wiring for loose connections and for worn wires or frayed wires.
- Check the fuel supply. Drain water from the water separator (if equipped). Open the fuel supply valve.
- Do not start the engine or move any of the controls if there is a "DO NOT OPERATE" warning tag or similar warning tag attached to the start switch or to the controls.
- Ensure that the areas around the rotating parts are clear.
- All of the guards must be put in place. Check for damaged guards or for missing guards. Repair any damaged guards. Replace damaged guards and/or missing guards.
- Disconnect any battery chargers that are not protected against the high current drain that is created when the electric starting motor (if equipped) is engaged. Check electrical cables and check the battery for poor connections and for corrosion.

- Reset all of the shutoffs or alarm components.
- Check the engine lubrication oil level. Maintain the oil level between the “ADD” mark and the “FULL” mark on the oil level gauge.
- Check the coolant level. Observe the coolant level in the coolant recovery tank (if equipped). Maintain the coolant level to the “FULL” mark on the coolant recovery tank.
- If the engine is not equipped with a coolant recovery tank maintain the coolant level within 13 mm (.5 inch) of the bottom of the filler pipe.
- Observe the air cleaner service indicator (if equipped). Service the air cleaner when the yellow diaphragm enters the red zone, or when the red piston locks in the visible position.
- Ensure that any driven equipment has been disengaged. Remove any electrical loads.

### 5-1.12.1 Cold Weather Starting

Starting the engine and operation in cold weather is dependent on the type of fuel that is used, the oil viscosity, and other optional starting aids. For more information see “[Cold Weather Operation](#)” section in this manual.

### 5-1-12.2 Starting the Engine

#### WARNING!!

**DO NOT USE ETHER (starting fluids) unless specifically instructed to do so. The use could result in engine damage and/or personal injury.**

**When using starting fluid, follow the manufacturer’s instructions carefully. Use starting fluid sparingly and spray it ONLY WHILE CRANKING THE ENGINE. Excessive ether can cause piston and ring damage. Use ether for cold weather starting purposes only.**

Use the following procedure in order to start the engine:

1. Engage the parking brake. Place the transmission in NEUTRAL.
2. Turn the ignition key switch to the ON position. The “CHECK ENGINE/DIAGNOSTIC” lamp will illuminate for 5 seconds when the ignition key switch is first turned on. If the lamp fails to illuminate, notify your authorized Caterpillar dealer. If the lamp continues to stay on, the ECM has detected a problem in the system. Refer to “[Engine Diagnostics](#)” in this manual.



**NOTICE:** Do not engage the starting motor when flywheel is turning. Do not start the engine under load.

If the engine fails to start within 30 seconds, release the starter switch or button and wait two minutes to allow the starting motor to cool before attempting to start the engine again.

3. Turn the ignition key switch to the START position in order to crank the engine. Do not push the throttle or hold the throttle downward while the engine is cranked. The system will automatically provide the correct amount of fuel in order to start the engine. If the engine does not start after 30 seconds of cranking, release the ignition key switch. Turn the ignition key switch to the OFF position. Allow the starting motor to cool for two minutes. Repeat Steps 2 and 3.



**NOTICE:** Oil pressure should rise within 15 seconds after the engine starts. Do not increase engine speed until the oil pressure gauge indicates normal. If oil pressure is not indicated in the gauge within 15 seconds. DO NOT operate the engine. STOP the engine, investigate and correct the cause.

4. Release the ignition key switch to the ON or RUN position immediately after the engine starts. After the engine starts, ensure that the transmission is still in the NEUTRAL position and release the clutch pedal (manual transmission). Once a normal engine oil and air pressure is reached, the vehicle may be operated at a light load and low speed.

### 5-1.12.3 Starting Problems

An occasional starting problem may be caused by one of the following items:

- Low battery charge
- Lack of fuel
- Problem with the wiring harness

If the engine fuel system has been run dry, fill the fuel tank and prime the fuel system. Refer to “*Fuel System - Prime*” in this manual.

If the other problems are suspected, perform the appropriate procedure in order to start the engine.

### 5-1.12.4 Problems with the Wiring Harness

Locate the ECM. Two harness connectors are attached to the ECM. The left connector is the engine harness and the right connector is the chassis harness. Check the connectors in order to ensure that the connectors are secure. Lightly pull each of the wires in the chassis harness.

1. Pull each wire with approximately 4.5 kg (10 lb) of force. The wire should remain in the connector.
2. If a wire is loose, push the wire back into the connector. Pull the wire again in order to ensure that the wire is secure.
3. Start the engine. If the engine does not start, consult the nearest Caterpillar dealer for assistance.

### 5-1.12.5 Starting with Jump Start Cables

**WARNING!!**

**Improper jump start cable connections can cause an explosion resulting in personal injury.**

**Prevent sparks near the batteries. Sparks could cause vapors to explode. Do not allow jump start cable ends to contact each other or the engine.**

If the installation is not equipped with a backup battery system, it may be necessary to start the engine from an external electrical source.

First, determine the reason that it is necessary to start with power from an external source.

Many batteries which are considered unusable are still rechargeable. After jump starting, the alternator may not be able to fully recharge batteries that are severely discharged. The batteries must be charged to the proper voltage with a battery charger. For information on charging and testing see your Caterpillar dealer.



**NOTICE:** Using a battery source with the same voltage as the electric starting motor. Use ONLY equal voltage for jump starting. The use of higher voltage will damage the electrical system.

Do not reverse the battery cables. The alternator can be damaged. Attach ground cable last and remove first.

When using an external electrical source to start the engine, turn the engine control switch to the “OFF” position. Turn all electrical accessories OFF before attaching the jump start cables.

Ensure that the main power switch is in the OFF position before attaching the jump start cables to the engine being started.

1. Turn the start switch on the stalled engine to the OFF position. Turn off all accessories.
2. Connect one positive end of the jump start cable to the positive cable terminal of the discharged battery. Connect the other positive end of the jump start cable to the positive cable terminal of the electrical source.
3. Connect one negative end of the jump start cable to the negative cable terminal of the electrical source. Connect the other negative end of the jump start cable to the engine block or to the chassis ground. This procedure helps to prevent potential sparks from igniting combustible gases that are produced by some batteries.
4. Charge the batteries. The engine will not continue to run after starting if the batteries have not been charged.
5. Start the engine.
6. Immediately after the stalled engine is started, disconnect the jump start cables in reverse order.

Refer to the Electrical Schematic for your engine. Consult your Caterpillar dealer for more information.

## 5-1.13 Engine Operation

### 5-1.13.1 Engine Operation

Proper operation, driving techniques and maintenance are key factors in obtaining the maximum service life and economy of Caterpillar engines. The recommendations in this manual will help to lower operating costs. For more information see your Caterpillar dealer.

### 5-1.13.2 Idling

Idle speed is adjustable on Caterpillar electronic engines. Consult your Caterpillar dealer for information. The idle rpm is preset at 600 rpm.

Avoid excess idling. If the vehicle is parked for more than five minutes, stop the engine. An engine can burn from 2.8 L (.7 US gal) to 5.7 L (1.5 US gal) of fuel per hour while the engine is idling. Excessive idling can cause carbon buildup and/or excessive idling can cause the engine to slobber. This is harmful to the engine.

If extended idle time is required, control the engine rpm to 1000 rpm or above 1000 rpm. Ensure that the coolant temperature exceeds 82 °C (180 °F) Consult your Caterpillar dealer for assistance.

Fast idle can be programmed within the range of 700 rpm to the top engine limit. Fast idle requires an "ON/OFF" switch on the dashboard. Consult your Caterpillar dealer for assistance.

### 5-1.13.3 Idle Shutdown Timer

The idle shutdown timer can be programmed in order to shut down the engine after a specific time period of idling. The idle time can be programmed from three minutes to 1440 minutes (24 hours). If the idle shutdown timer is set to 0 minutes, the idle shutdown feature is disabled. If the setting of the timer is unknown, allow the engine to idle. Observe the time that elapses before the engine shuts down. The following conditions must be met in order to activate the idle shutdown timer:

- The idle shutdown feature must be selected.
- No vehicle speed is detected by the Electronic Control Module (ECM).
- The engine is not under load.
- The engine is at operating temperature. The engine is not in Cold Mode.

After the vehicle is stationary, the idle shutdown timer begins. The engine can be operating at low idle or at an idle or at an idle rpm that is selected by the idle governor. The "CHECK ENGINE/DIAGNOSTIC" lamp will flash rapidly for 90 seconds prior to shutdown. Movement of the vehicles automatically resets the idle shutdown timer to the programmed setting.

The following conditions must be met in order to override the idle shutdown timer:

1. Program the "ALLOW IDLE SHUTDOWN OVERRIDE" to "YES".
2. The "CHECK ENGINE/DIAGNOSTIC" lamp will flash rapidly for 90 seconds prior to shutdown. Depress the service brake or the clutch pedal during the 90 seconds when the "CHECK ENGINE/DIAGNOSTIC" lamp flashes.

After an idle shutdown, the engine can be restarted without turning the ignition switch to the OFF position.

The override function is disabled if the "ALLOW IDLE SHUTDOWN OVERRIDE" is programmed to "NO".

### 5-1.13.4 Cold Mode Operation

Cold mode is initiated if the coolant temperature is below 28°C (82°F). Engine power is decreased until the coolant temperature reaches the above value. In cold mode, the idle is 800 rpm for the C11 and the C13. The strategy for cold mode provides reduced smoke emission and faster warm-up time.

After the cold mode is completed, the engine should be operated at low rpm and low load until normal operating temperature is reached. The engine will reach normal operating temperature faster when the engine is operated at low rpm and low power demand. This method is faster than trying to reach operating temperature by idling with no load.



**NOTICE:** It is not recommended that the vehicle be moved until the engine is out of cold mode. Power may be noticeably reduced if the vehicle is operated when the engine is in cold mode. At a speed above 8 km/h (5 mph), the low idle speed will be reduced to the customer programmed low idle speed. The power will still be reduced.

Cold mode is disabled if the throttle, the service brake, or the clutch (if equipped) is depressed. The rpm for cold mode operation drops to the programmed low idle speed in order to allow the transmission to be put into gear.

### 5-1.13.5 Getting Started

Caterpillar electronic engines do not require long warm-up periods that needlessly waste fuel. Typically, the engine should be at normal operating temperature in a few minutes. Begin operating the engine at low load. After normal oil pressure is reached and the temperature gauges begin to rise, the engine may be operated at full load.

To get the vehicle in motion, use a gear that will result in a smooth start. Move the load without increasing the engine rpm above low idle or without slipping the clutch. Engage the clutch smoothly. Slipping the clutch and engaging the clutch can cause stress to occur on the drive train. This can also cause fuel to be wasted.

Use progressive shifting techniques. Progressive shifting is using only the rpm that is required in order to upshift into the next gear. Progressive shifting improves fuel economy.

- Keep the engine rpm to a minimum. Use an rpm that is from 1200 to 1600 rpm.
- Use only enough rpm to pick up the next gear.

Progressive shifting also reduces the acceleration rate. Top gear is reached sooner because less time is needed to synchronize the gears during shifting. In addition, the engine is operating at the highest range of torque.

The amount of rpm that is required to upshift increases as the vehicle speed increases, unless upshifts are made on upgrades. Experience with the vehicle will show the amount of rpm that is required to upshift under various conditions.



**NOTE:** These engines may be programmed to encourage progressive shifting. The acceleration rate may slow down at certain rpm in lower gears. If this occurs, progressive shift parameters may have been programmed into the ECM. Progressive shift parameters will limit the rpm when the vehicle is driven in higher gears. These parameters are protected by customer passwords. If the vehicle can be operated in a higher gear at a vehicle speed that is desired, select the highest gear that is available to pull the load. This recommendation will help to obtain fuel economy. The engine will be operating at the lowest rpm that is required to pull the load.

### 5-1.13.6 Vehicle Efficiency

An efficient vehicle performs the desired amount of work while the power demand on the engine is minimized. The following factors are major contributors to power demand:

- Aerodynamic drag (wind resistance)
- Rolling resistance of the tires
- Gross weight of the vehicle
- Losses in the drive train and the load from the engine driven accessories

For more information about vehicle efficiency, consult the Caterpillar website <http://www.caterpillar.com> or consult your Caterpillar dealer.



### 5-1.13.7 Fuel Economy

Fuel is the largest single operating cost of today's on-highway engines. Improved fuel economy can have a substantial impact on operating profit. The following items are the most significant factors that influence vehicle fuel economy:

- Driver techniques
- Vehicle efficiency
- Operating conditions
- Engine efficiency

A No. 1 grade of fuel contains less energy per volume and increases fuel consumption. A greater volume of fuel must be injected in order to yield the same amount of work as a No. 2 fuel. The difference in the fuel economy between the two grades of fuel can be as great as 0.2 km/L (.5 mpg) to 0.3 km/L (.7 mpg).

For more information about fuel economy consult the Caterpillar website at <http://www.caterpillar.com> or see your Caterpillar dealer.

Rolling hills provide a great opportunity to reduce fuel consumption. Avoid downshifting on small hills. The vehicle should not be downshifted even if the engine must be lugged down to an rpm that is below the peak torque rpm. When the vehicle is going down a hill, use gravity instead of the engine's power to regain vehicle speed.

On grades that require more than one downshift, allow the engine to lug to peak torque rpm. If the engine is running at peak torque rpm or above peak torque rpm and the rpm stabilizes, remain in that gear.

Long steep down grades should be anticipated. Reduce the speed of the vehicles before you crest the top of a hill and before you proceed down a long, steep grade. Minimize the amount of braking that is used in order to maintain a safe speed for maximizing fuel efficiency.

The engine's ability to hold the vehicle back increases with engine rpm. Select a gear that runs the engine near the high engine rpm limit for long steep hills when braking is required.

Speed reductions and future stops should be anticipated. Downshifts should be avoided. The amount of braking should be minimized in order to improve fuel consumption. By coasting to a stop, a vehicle can travel a considerable distance without consuming any fuel.

### 5-1.13.8 Cruising

Vehicles that are driven faster consume more fuel. Increasing the cruising speed from 88 km/h (55 mph) to 104 km/h (65 mph) will increase the fuel consumption of a typical Class 8 vehicle by approximately 0.4 km/L (1 mpg). When a vehicle is driven fast in order to allow more time for stops, the stops become very expensive. Cruising allows the engine to operate in the most efficient rpm range (1100 to 1500 rpm).

### 5-1.13.9 Cruise Control

The cruise control function is explained earlier in this manual in [Section 2\\_1 Instruments and Controls - Dash and Monitor Panels](#). Please refer to this section for instructions on use.

## 5-1.14 Engine Stopping

### 5-1.14.1 Stopping the Engine



**NOTICE:** Stopping the engine immediately after it has been working under load can result in overheating and accelerated wear of the engine components.

If the engine has been operating at high rpm and/or high loads, run at low idle for at least three minutes to reduce and stabilize internal engine temperature before stopping the engine.

Avoiding hot engine shutdowns will maximize turbocharger shaft and bearing life.

Prior to stopping an engine that is being operated at low loads, operate the engine at low idle for 30 seconds before stopping. If the engine has been operating at highway speeds and/or at high loads, operate the engine at low idle for at least three minutes. This procedure will cause the internal engine temperature to be reduced and stabilized.

Ensure that the engine stopping procedure is understood. Stop the engine according to the shutoff system on the vehicle.

- To stop the engine, turn the ignition key switch to the OFF position.

### 5-1.14.2 After Stopping the Engine

- Check the crankcase oil level. Maintain the oil level between the “ADD” mark and the “FULL” mark on the oil level gauge.
- If necessary, perform minor adjustments. Repair any leaks and tighten any loose bolts.
- Note the service hour meter reading. Perform the maintenance that is in the “*Maintenance Interval Schedule*” section of this manual.
- Fill the fuel tank in order to help prevent accumulation of moisture in the fuel. Do not overfill the fuel tank.



**NOTICE:** Only use antifreeze/coolant mixtures recommended in the *Coolant Specifications* of this manual. Failure to do so can cause engine damage.

- Allow the engine to cool. Check the coolant level. Maintain the cooling system at 13 mm (.5 inch) from the bottom of the pipe for filling.
- If freezing temperatures are expected, check the coolant for proper antifreeze protection. The cooling system must be protected against freezing to the lowest expected outside temperature. Add the proper coolant/water mixture, if necessary.
- Perform all required periodic maintenance on all driven equipment.

## 5-1.15 Cold Weather Operation

### 5-1.15.1 Radiator Restrictions

Caterpillar discourages the use of airflow restriction devices that are mounted in front of radiators. Airflow restriction can cause the following conditions:

- High exhaust temperatures
- Power loss
- Excessive fan usage
- Reduction in fuel economy

Shutters can be properly used for parking overnight, very cold temperatures, and high winds. In those particular cases, the coolant temperature and the inlet manifold temperature must be carefully monitored and controlled.



**NOTICE:** Failure to open the winter fronts in the morning could cause engine damage and/or loss of fuel economy.

### 5-1.15.2 Fuel and the Effect from Cold Weather

The following fuels are in the grades that are available for Caterpillar engines:

- No. 1
- No. 2
- Blend of No. 1 and No. 2

No. 2 diesel fuel is the most commonly used fuel. Either No. 1 diesel fuel or a blend of No. 1 and No. 2 is best suited for cold weather operation.

Quantities of No. 1 diesel fuel are limited. No. 1 diesel fuels are usually available during the months of the winter in the colder climates. During cold weather operation, if No. 1 diesel fuel is not available, use No. 2 diesel fuel, if necessary.

There are three major differences between No. 1 and No. 2 diesel fuel. No. 1 diesel fuel has the following properties:

- Lower cloud point
- Lower pour point
- Lower rating of BTU per unit volume of fuel

When No. 1 diesel fuel is used, a decrease in power and in fuel efficiency may be noticed. Other operating effects should not be experienced.

The cloud point is the temperature when a cloud of wax crystals begins to form in the fuel. These crystals can cause the fuel filters to plug. The pour point is the temperature when diesel fuel will thicken. The diesel fuel becomes more resistant to flow through fuel pumps and through fuel lines.

Be aware of these values when diesel fuel is purchased. Anticipate the average ambient temperature of the area that the engine will be operated. Engines that are fueled in one climate may not operate well if the engines are moved to another climate. Problems can result due to changes in temperature.

Before troubleshooting for low power or for poor performance in the winter, check the type of fuel that is being used.

When No. 2 diesel fuel is used the following components provide a means of minimizing problems in cold weather:

- Starting aids
- Engine oil pan heaters
- Engine coolant heaters
- Fuel heaters
- Fuel line insulation

### 5-1.15.3 Fuel Related Components in Cold Weather

#### Fuel Tanks

Condensation can form in partially filled fuel tanks. Top off the fuel tanks after operating the engine.

Fuel tanks should contain some provision for draining water and sediment from the bottom of the tanks. Some fuel tanks use supply pipes that allow water and sediment to settle below the end of the fuel supply pipe.

Some fuel tanks use supply lines that take fuel directly from the bottom of the tank. If the engine is equipped with this system, regular maintenance of the fuel system filter is important.

Drain the water and sediment from any fuel storage tank at the following intervals:

- Weekly
- Oil Changes
- Refueling of the Fuel Tank

This will help prevent water and/or sediment from being pumped from the fuel storage tank and into the engine fuel tank.

#### Fuel Filters

A primary fuel filter and/or a water separator is installed between the fuel tank and the engine mounted fuel filter. The primary fuel filter and the fuel supply line are commonly affected by cold fuel. The primary fuel filter is mounted in the engine compartment. The primary fuel filter will benefit from the radiant heat of the engine.

#### Fuel Heaters

Fuel heaters help to prevent fuel filters from plugging in cold weather due to waxing. If coach is going to be driven extensively in cold weather a fuel heater may want to be considered. If a fuel heater is purchased it should be installed so that the fuel is heated before the fuel enters the primary fuel filter.

To select a fuel heater, contact your Caterpillar dealer.

The following fuel heaters are recommended for use with Caterpillar engines:

- 7C-3557 Fuel Heater Group
- 7C-3558 Heater Kit

Your Caterpillar dealer can give you full information on the benefits of fuel heaters and which type would be best for you.



## 5-2 Engine Messenger Display System

### 5-2.1 Introduction

This display is intended to allow the driver to monitor the vehicle and engine information while the vehicle is being operated. The display may also display stored trip information. When possible, the driver should select the proper display screen before operating the vehicle.

#### CAUTION!!

Select the desired display prior to moving the vehicle. Do not manipulate the display while the vehicle is moving. This could divert attention from driving efforts and result in personal injury or equipment damage.

Do not perform any procedure that is outlined in this manual until you have read the information and you understand the information.

### 5-2.2 Features of Messenger Display

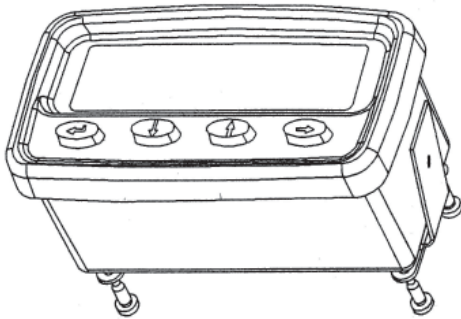

Figure 1 - Messenger Display

The Messenger display may show information for the engine and the vehicle. For detailed operating information, see the [Operation](#) Section later in this manual. The driver should review the information in this manual prior to driving. Before driving, the driver should review the Messenger Screen Map in order to select the most important information for the trip. This will avoid the entry of data during the operation of the vehicle.



**NOTICE:** The electronic service tool may be used to make changes to the display. Power to the display must be cycled in order for the changes to be viewed. The display may be used to make changes to options of the display. Changes may be viewed on the screen after the display is returned to the title screen of each column.

#### 5-2.2.1 Engine Operating Information

The Messenger display provides information on cruise control set speed, PTO engine rpm set speed, fuel temperature to the engine, boost and oil pressure, coolant temperature, and intake manifold temperature.

#### 5-2.2.2 Vehicle Trip Information

The Messenger display provides information concerning the quantity of fuel that has been used, the fuel economy, the average vehicle speed, idle time, PTO time, percent idle hour, idle fuel, and PTO fuel. These parameters may relate to trip segments or to the engine history. A Driver and a Fleet Trip Segment is available for the C13 engine. For the Driver Trip Segment, the driver determines the start and stop points. For the Fleet Trip Segment, the vehicle owner determines the start and stop points. The vehicle may be operated in separate states. The Fleet Trip Segment may be tied to each of these states. The Fleet Trip Segment may be split between two drivers and two ID codes.

#### 5-2.2.3 Maintenance Information

The last oil change may be entered. This allows the display to indicate when the next oil change is due.

#### 5-2.2.4 Diagnostic Data

Engine diagnostic codes may be displayed for the driver. The Messenger display will automatically display potentially serious engine problems. When one of these codes appears, the driver should bring the vehicle to a safe stop. After the display of a serious diagnostic code, the engine may shut down within 20 seconds. Refer to the [Diagnostic Codes Chart](#) for a list of these codes.

### 5-2.2.5 Theft Deterrent

Messenger provides the capability to allow the engine to start or the capability to prevent the engine from starting. The Messenger display can shut down the engine after entering a password with four characters into the display when the engine is at idle.

### 5-2.2.6 Fuel Correction Adjustment

Messenger provides the capability to adjust the Fuel Correction Factor of the ECM.

### 5-2.2.7 Configuration of the Display

Messenger can provide information in either English, French or Spanish. Units of measure can be displayed in English (miles per hour, US gallons, psi, and °F), English (miles per hour, Imperial gallons, psi, and °F), or Metric units (kilometer per hour, liters, kPa, and °C). The French or Spanish manuals may be ordered by contacting a Caterpillar dealer.

Units		
Parameter Identifier	English Unit Abbreviation	Metric Unit Abbreviation
“Distance”	Miles - MI	Kilometers - KM
“English Speed”	Revolutions per minute - RPM	Revolutions per minute - RPM
“Fuel Economy”	Miles per gallon - MPG	Kilometers per liter (“KPL”) Liters per 100 - KM
“Fuel Quantity”	Gallons (US or Imperial Gallons) - GAL	Liters - LTR
“Fuel Rate”	Gallons Per Hour - GPH	Liters per hour - LPH
“Pressure”	Pounds Per Square Inch - PSI	Kilopascals - kPa
“Speed”	Miles Per Hour - MPH	Kilometers Per Hour - KPH
“Temperature”	Degrees Fahrenheit - F	Degrees Celsius - C
“Time”	Hours - HR	Hours - HR

### 5-2.2.8 Driver ID Entry

The Messenger display provides the capability to enter the ID of multiple drivers. This allows the ECM to log information for multiple drivers. This is useful in driving applications that involve several drivers.

### 5-2.2.9 State Crossing

Messenger allows the driver to enter the current state.

### 5-2.2.10 Access to Parameters

The availability of parameters is determined by the engine manufacturer, the model year of the engine, and the ECM settings for the Customer Programmable Parameters.

Table 2

Parameter Programming by Engine Model	
Engine	Access
C13	All 3176B, 3176C, 3406E, C-10, C11, C-12, C13, C15, C-15, and C-16 functions.

### 5-2.2.11 Display Functions

**Functions of Buttons on the Display** - Simultaneously pressing and releasing the two center buttons (Down and Up) will cause the display screen to return to the title screen (Instantaneous Data) of the display.

**Adjusting the Brightness of the Display** - The display will automatically be dimmed when the headlights are turned ON and the display is connected to the lighting circuit. The illumination of the display may be adjusted manually.

1. The contrast may be adjusted by pressing and releasing the Right arrow button and the Left arrow button from the Adjust Contrast screen. The characters may be lightened by pressing and releasing the Left arrow button until the illumination is satisfactory. The background may be darkened by pressing and releasing the Right arrow until the background is satisfactory.
2. The Down arrow button may be used in order to change the backlight. The backlight may be turned off by pressing and releasing the Left arrow button. The backlight may be turned on by pressing and releasing the Right arrow button.
3. The backlight may be adjusted by pressing the Down arrow button. Pressing and releasing the Left arrow button will decrease the backlight. Pressing and releasing the Right arrow button will increase the backlight.

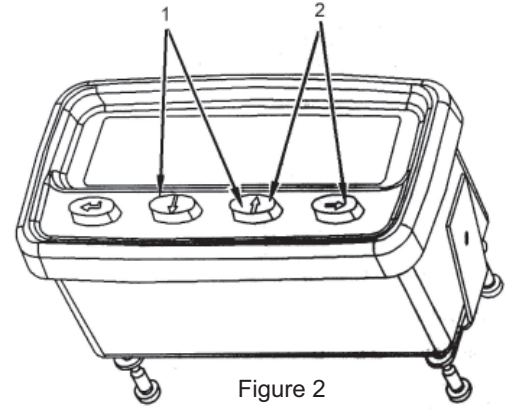

Figure 2

Front view of Messenger display  
(1) Home buttons  
(2) Display dimming buttons



**NOTE:** The automatic dim feature will not function if the display has been placed in a manual dim mode. To reactivate the automatic dim feature, turn the power to the display OFF, then back ON.

### 5-2.2.12 Additional Features

The Messenger display may be mounted in or on the dash.

The display allows an inside view of the engine's operation. The Messenger's display provides information to the driver from the engine's Electronic Control Module (ECM) through the J1708 Data Link.

The Messenger screen has a LCD display.

## 5-2.3 Messenger Display Screen Map

In order to view specific information, a Messenger Display Screen Map is provided in this manual. Arrows are attached to each block of the Screen Map. The arrows indicate the actual arrow buttons that are available with each screen. Pressing an arrow that is not shown will have no effect. The display will remain at the same screen.

The first row of the screen map indicates the title screen for each of the columns on the screen map. The farthest title screen to the right and the "INSTANTANEOUS DATA" title screen in column 1 are adjacent in operation. Pressing the right arrow button from the farthest right title screen moves to the "INSTANTANEOUS DATA" title screen in column 1.

Movement between the columns of information is permitted when the title screen can be viewed. The exception is movement between the "Fleet Trip", "Driver Trip", and "Lifetime Total" columns. These columns are available with 3176B, 3176C, C-10, C11, C-12, C13, C15, C-15, C-16, and 3406E engines.

The Up and Down arrow buttons allow movement up and down through the columns. When the bottom screen of a column is being viewed, press the Down arrow button in order to view the title screen at the top of the column. You cannot press the Up arrow button from the title screen to get to the bottom screen.

3176B, 3176C, C-10, C11, C-12, C13, C15,  
C-15, C-16, and 3406E Engines  
Expanded Messenger Screen Map (Column 1-4)

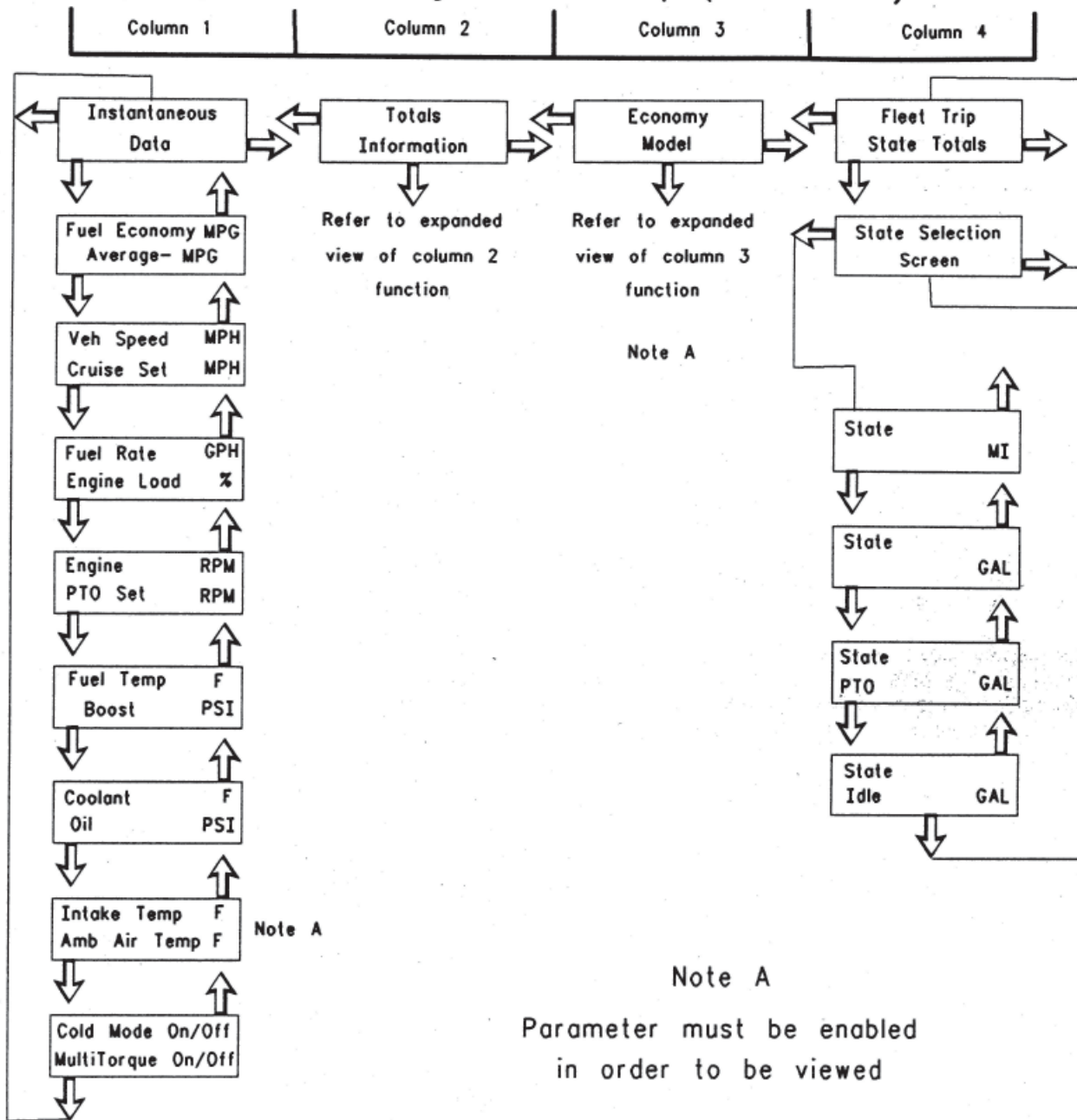

Figure 3 - "Screen maps for the heavy duty truck engine (columns 1-4)"



3176B, 3176C, 3406E, C-10, C11, C-12, C13, C15,  
C-15, and C-16 Engines

Expanded Messenger Screen Map for Totals  
Column 2 - Driver - Fleet - Lifetime

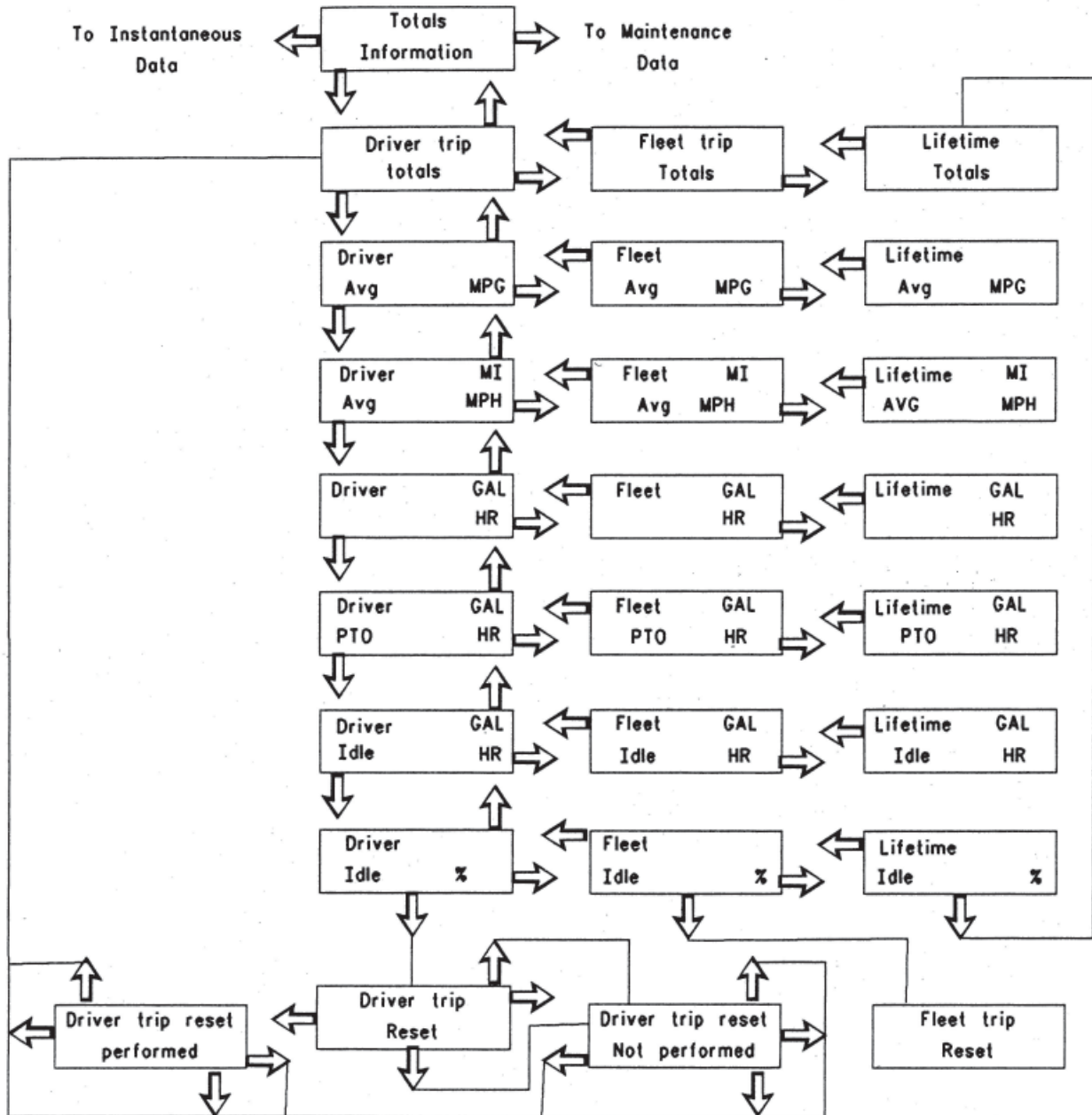

Figure 4 - "Screen map for the heavy duty truck engine (column 2-driver-fleet-lifetime)"

3176B, 3176C, 3406E, C-10, C11, C-12, C13, C15,  
C-15, and C-16 Engines

Expanded Messenger Screen Map  
Column 3 - Driver Economy Reward

Note: Parameter must be enabled  
in order to be viewed.

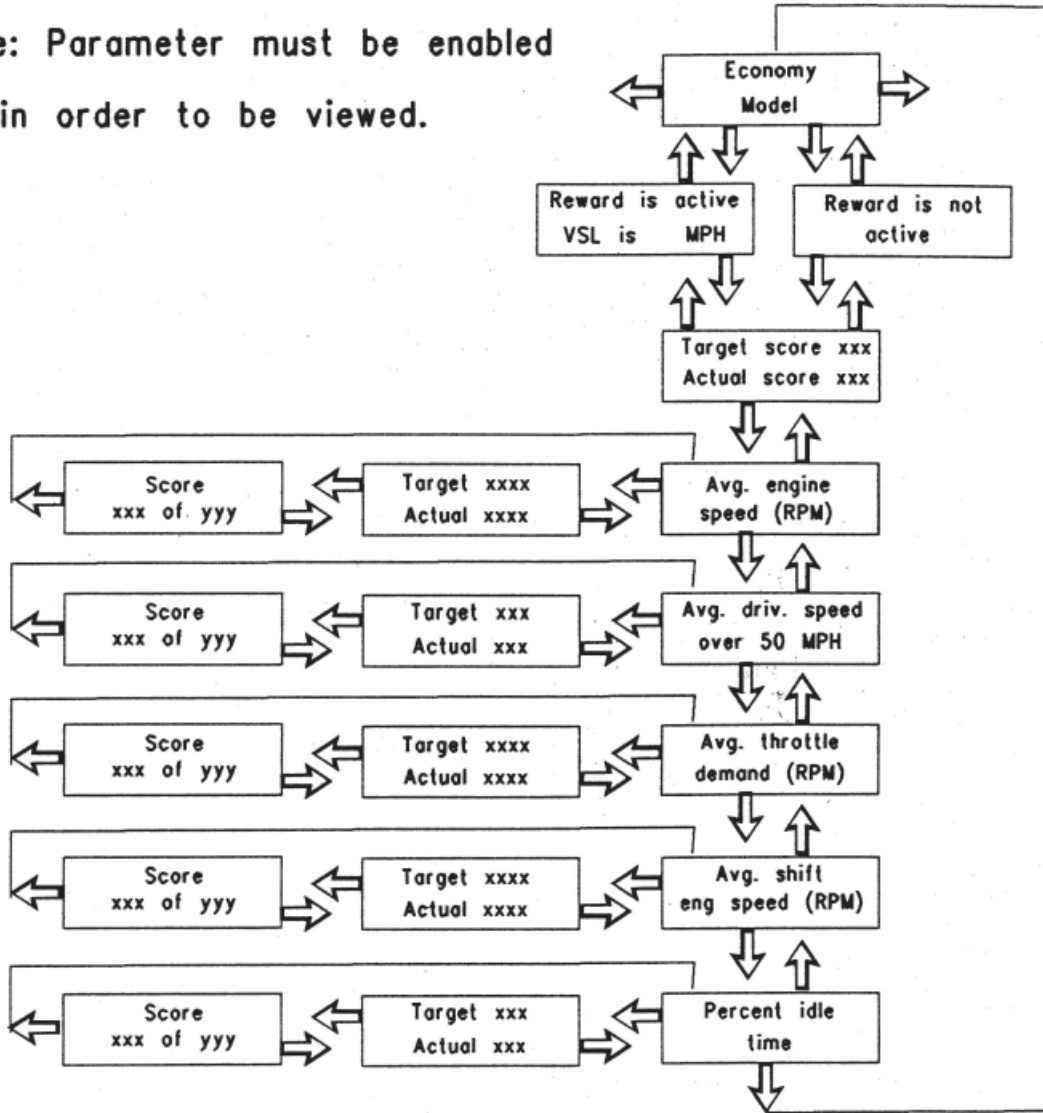
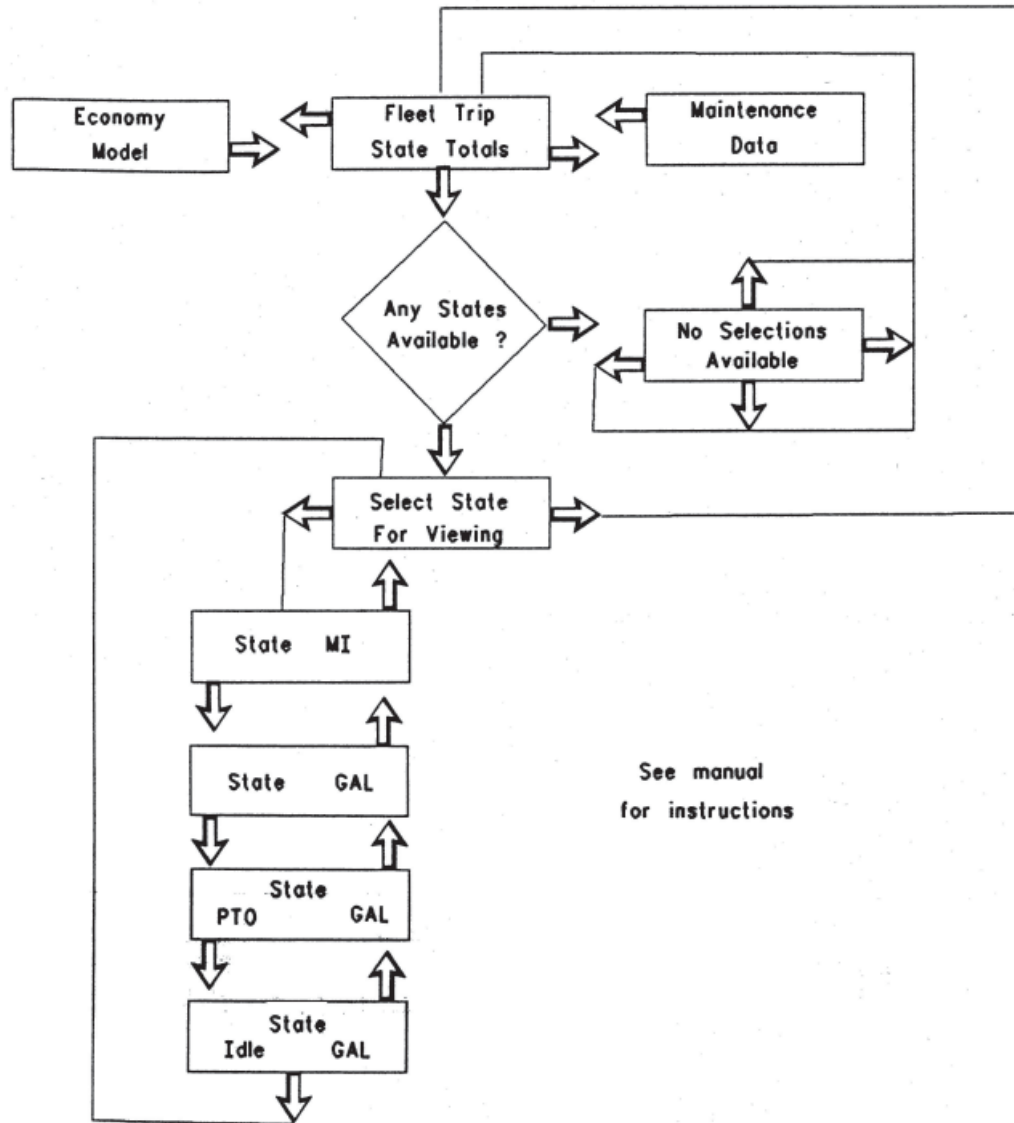

Figure 5 - "Screen map for the heavy duty truck engine screen map (column 3)"

3176B, 3176C, 3406E, C-10, C11, C-12, C13, C15,  
C-15, and C-16 Engines

Expanded Messenger Screen Map (Column 4)

Column 4



See manual  
for instructions

Figure 6 - "Screen map for the heavy duty truck engine (column 4)"

3176B, 3176C, 3406E, C-10, C11, C-12, C13

C15, C-15, and C-16 Engines

Expanded Messenger Screen Map (Column 5)

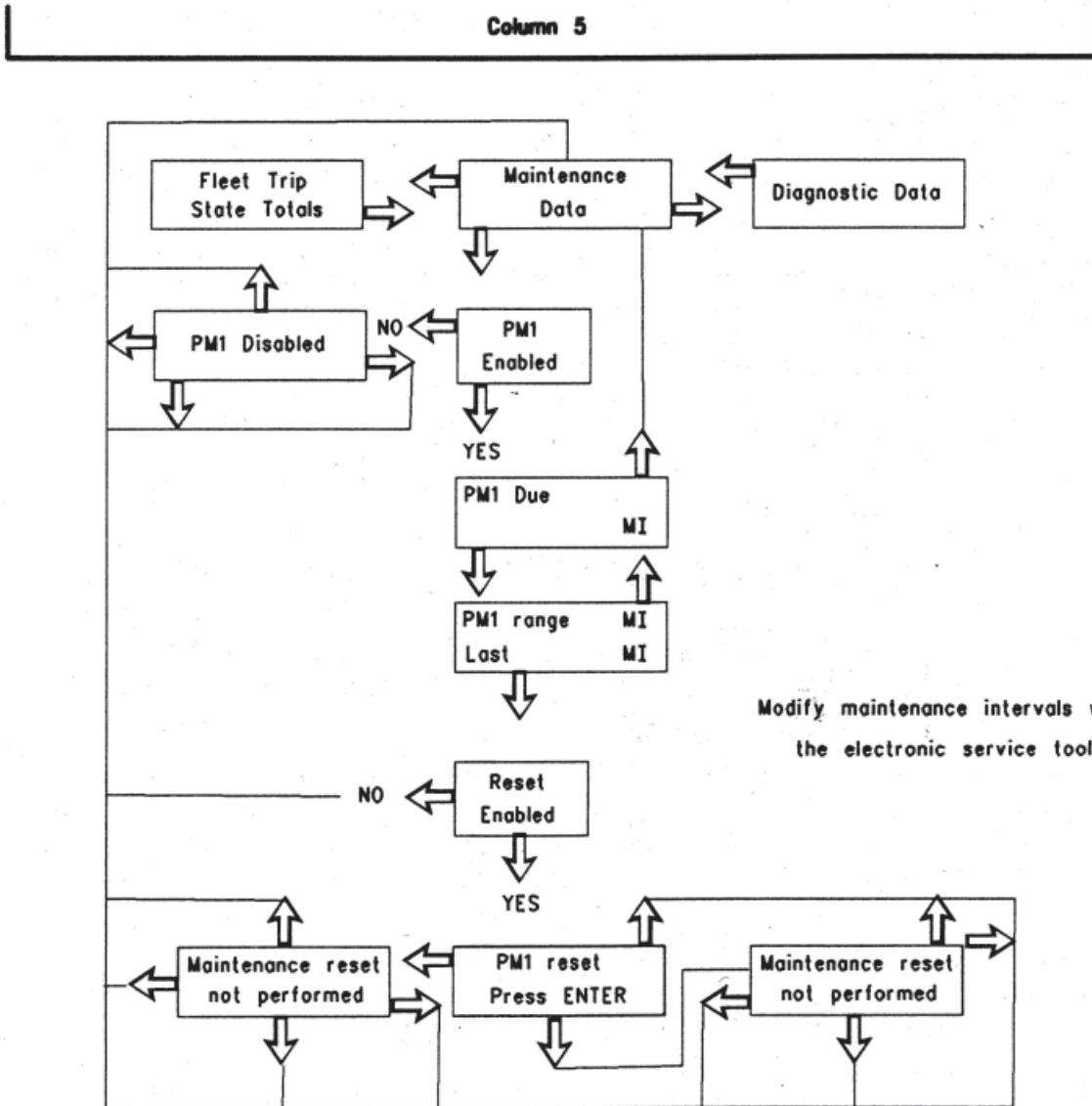
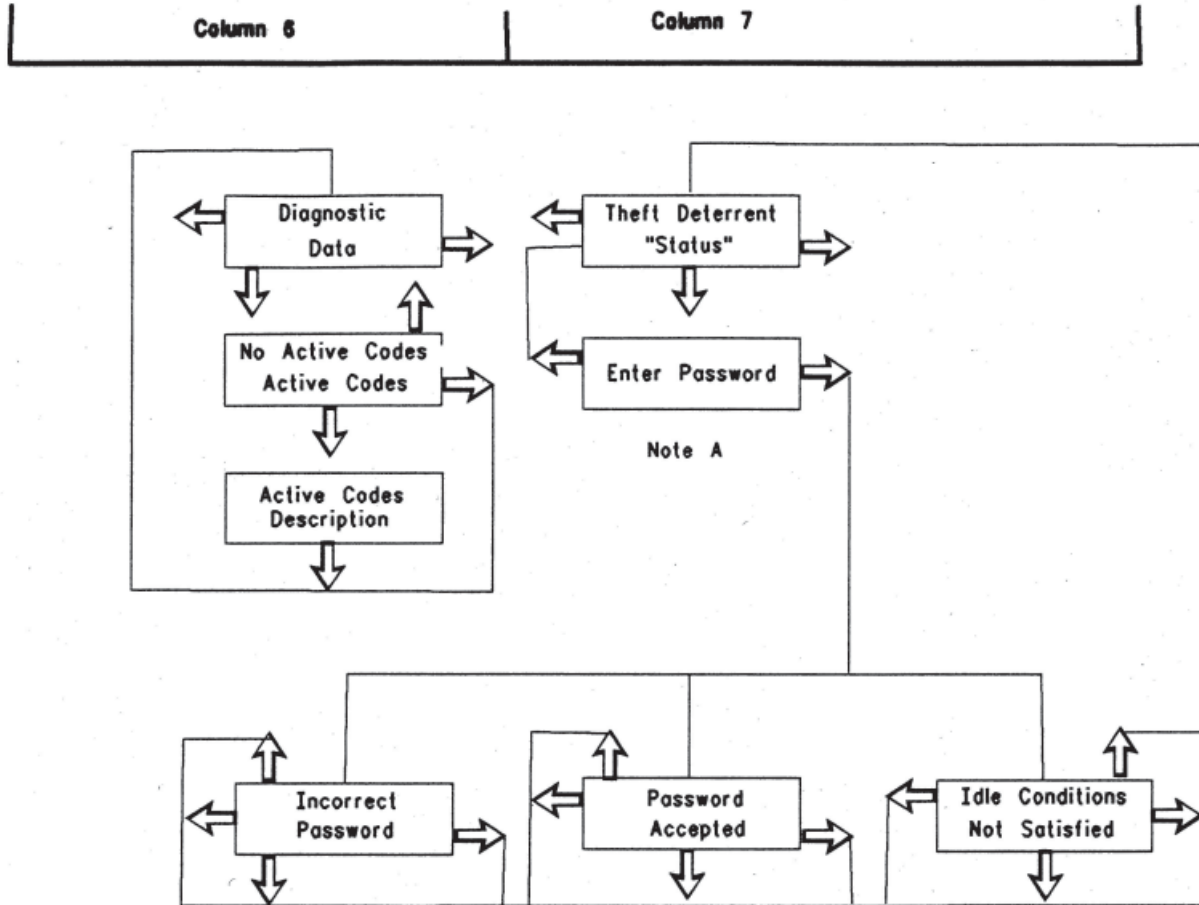

Figure 7 - "Screen map for the heavy duty truck engine (column 5)"

3176B, 3176C, 3406E, C-10, C11, C-12, C13  
 C15, C-15, and C-16 Engines  
 Expanded Messenger Screen Maps (Columns 6-7)



See manual for instructions

Note A: Password screen can accept or cancel entry

Figure 8 - "Screen maps for the heavy duty truck engine (columns 6-7)"

3176B, 3176C, 3406E, C-10, C11, C-12, C13,  
C15, C-15, and C-16 Engines  
Expanded Messenger Screen Map (Columns 8-10)

Column 8	Column 9	Column 10
----------	----------	-----------

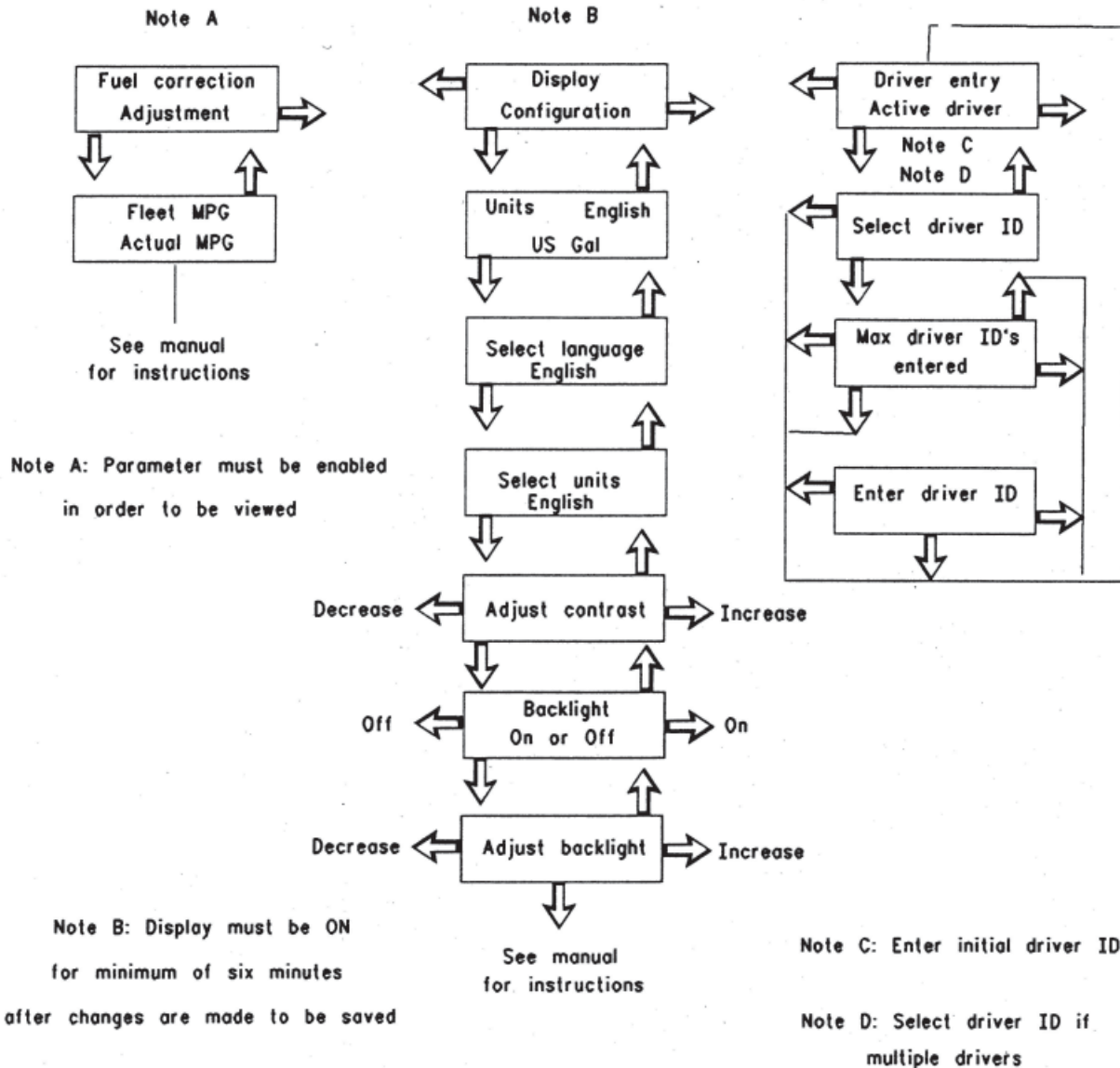
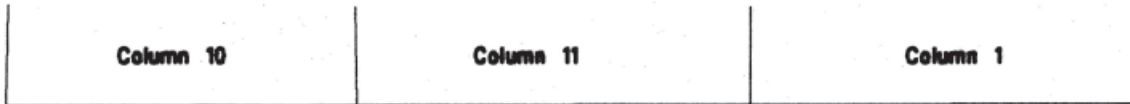

Figure 9 - "Screen maps for the heavy duty truck engine (columns 8-10)"

3176B, 3176C, 3406E, C-10, C11, C-12, C13,  
C15, C-15, and C-16 Engines

Expanded Messenger Screen Map (Column 11)



Note A

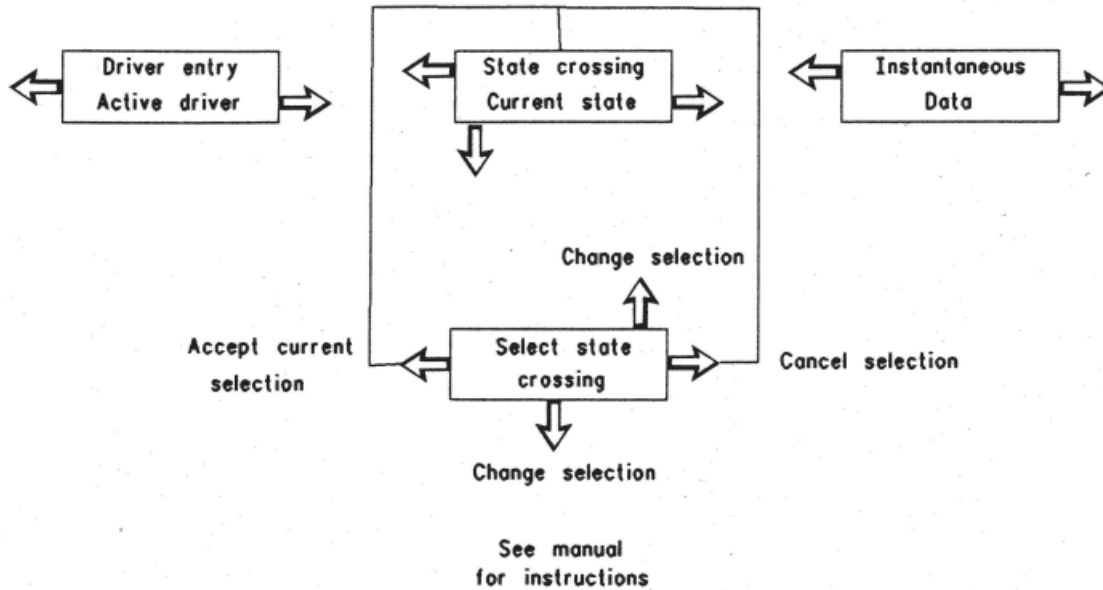

States on the screen are listed alphabetically as follows:

Note: Parameter must be enabled  
in order to be viewed

- 1) Current state
- 2) States adjacent to current state
- 3) All remaining states not listed in item 2

Figure 10 - "Screen maps for the heavy duty truck engine (column 11)"

## 5-2.4 “Instantaneous Data” Screens

The display can indicate the status of sixteen engine and vehicle operating conditions. The “INSTANTANEOUS DATA” can include “Current Fuel Economy”, “Fleet Trip Segment Fuel Economy”, “Vehicle Speed”, “Cruise Set Speed”, “Fuel Rate”, “Engine Load”, “Engine Speed”, “PTO Set Engine Speed”, “Fuel Temperature Boost Pressure”, “Coolant Temperature”, “Oil Pressure”, “Intake Manifold Temperature”, “Ambient Air Temperature”, “Cold Mode Status”, and “Multi-Torque Status”.

Remember that not all engines support all of the “INSTANTANEOUS DATA” parameters. The parameters that are supported depend on the type of engine. For example, 3126B engines only support 11 of the 16 possible “INSTANTANEOUS DATA” parameters. View the appropriate screen map for the particular engine for a complete listing of “INSTANTANEOUS DATA” parameters.



**NOTE:** The engine parameters use the EC as the source of information for the display. The Messenger display and the instrument panel gauges may indicate different values. The display may respond differently to changing conditions as the vehicle operates. The readings between the gauges and display may be different. This does not indicate that the components are faulty.

### 5-2.4.1 “Instantaneous Data” Screens for the 3176B, 3176C, C-10, C11, C-12, C13, C15, C-15, C-16, and 3406E Engines

Table 3

Screen	Parameter	Description
Instantaneous Data	Instantaneous Data Title Screen	<ul style="list-style-type: none"> <li>– The display will return to this screen at any time during operation by pressing the Down button and Up button at the same time.</li> <li>– Press the Right arrow button in order to move the column of the display to the right.</li> <li>– Press the Left arrow button in order to move the column of the display to the left.</li> <li>– Press the Down arrow button in order to view the “FUEL ECONOMY-MPG/AVERAGE FUEL ECONOMY-MPG”.</li> </ul>
Fuel Economy “MPG” Average MPG	Current Fuel Economy. The Average Fuel Economy of the Fleet Trip Segment	<ul style="list-style-type: none"> <li>– With a vehicle speed of zero, the fuel economy is zero.</li> <li>– Data is available for 1994 or newer 3176B, 3176C, or 3406E engines only.</li> <li>– Press the Down arrow button to view “VEHICLE SPEED-MPH/CRUISE SET SPEED -MPH”.</li> <li>– Press the Up arrow button to view “INSTANTANEOUS DATA”.</li> </ul>
Vehicle Speed MPH Cruise Set Speed MPH	Vehicle Speed Cruise Control Set Speed	<ul style="list-style-type: none"> <li>– The screen shows the vehicle speed that the ECM is using for cruise control and PTO operation.</li> <li>– The screen shows the current cruise control speed that is set. The value will be zero if a cruise set speed has not been entered.</li> <li>– Press the Up arrow button in order to view “FUEL ECONOMY-MPG/AVERAGE-MPG”.</li> <li>– Press the Down arrow button in order to view “FUEL RATE/ENGINE LOAD”.</li> </ul>
Fuel Rate GPH Engine Load %	Instantaneous Fuel Rate Percent Load on the Engine	<ul style="list-style-type: none"> <li>– The fuel consumption per hour</li> <li>– This is a measure of the load demand on the engine. A higher value indicates that the engine is operating with a heavy load or the vehicle is being driven hard.</li> <li>– Press the Up arrow button in order to view “VEHICLE SPEED/CRUISE SET SPEED”.</li> <li>– Press the Down arrow button in order to view “/ENGINE SPEED/PTO SPEED”.</li> </ul>



### 5-2.4.1 “Instantaneous Data” Screens for the 3176B, 3176C, C-10, C11, C-12, C13, C15, C-15, C-16, and 3406E Engines continued

Table 3 - Continued

Screen	Parameter	Description
Engine RPM PTO Set RPM	Engine Speed PTO Set RPM	<ul style="list-style-type: none"> <li>- This screen displays the current engine speed and the engine speed is expressed in revolutions per minute (RPM).</li> <li>- This screen displays the engine speed set point while the engine is in PTO operation or extended idle. The value will be zero if a PTO set speed has not been entered.</li> <li>- Press the Up arrow button in order to view “FUEL RATE/ENGINE LOAD”.</li> <li>- Press the Down arrow button in order to view “FUEL TEMP/BOOST PRESSURE”.</li> </ul>
“Fuel Temp” (F) Boost (PSI)	Fuel Temperature Boost Pressure	<ul style="list-style-type: none"> <li>- Fuel Temperature</li> <li>- Intake Manifold Air Pressure</li> <li>- Press the Up arrow button in order to view “ENGINE RPM/PTO SET”.</li> <li>- Press the Down arrow button in order to view “COOLANT TEMP/OIL PSI”.</li> </ul>
Coolant F Oil PSI	Coolant Temperature Oil Pressure	<ul style="list-style-type: none"> <li>- Engine coolant temperature</li> <li>- Oil pressure</li> <li>- Press the Up arrow button in order to view “FUEL TEMP/BOOST PSI”.</li> <li>- Press the Down arrow button in order to view “INTAKE AIR TEMP/AMB AIR TEMP”.</li> </ul>
“Intake Temp” (F) “Amb Air Temp” (F)	“Intake Air Temp” “Ambient Air Temp”	<ul style="list-style-type: none"> <li>- Temperature of the air in intake manifold</li> <li>- Temperature of the ambient air</li> <li>- Press the Up arrow button in order to view “COOLANT TEMP/OIL PSI”.</li> <li>- Press the Down arrow button in order to view “COLD MODE/MULTI-TORQUE”</li> </ul>
“Cold Mode On/Off” “Multi-Torque” On/Off	Code Mode “Multi-Torque”	<ul style="list-style-type: none"> <li>- The engine is operating in Cold Mode.</li> <li>- The engine is operating in “Multi-Torque” mode.</li> <li>- Press the Up arrow button in order to view “INTAKE TEMP/AMB AIR TEMP”.</li> <li>- Press the Down arrow button in order to view “INSTANTANEOUS DATA”.</li> </ul>

## 5-2.5 Screen Display Information

### 5-2.5.1 Trip Segments

The Messenger display will provide operating data on the engine in a variety of ways. The Messenger display provides the method in order to label information for both driver and the vehicle owner. With the 3176B, 3176C, 3406E, C-10, C11, C-12, C13, C15, C-15, and C-16 engines, the Messenger display records information in three separate ways. Lifetime Totals, a Fleet Trip Segment, and a Driver Trip Segment are recorded.

### 5-2.5.2 Lifetime Totals

Lifetime totals are permanently stored in the ECM on the engines. The information is recorded throughout the life of the engine. The Lifetime Totals cannot be reset under normal operation. The Lifetime Totals cannot be deleted under normal operation. The Lifetime Totals are shown on the screen map for the Messenger Display.

### 5-2.5.3 “Totals Information” (3176B, 3176C, 3406E, C-10, C11, C-12, C13, C15, C-15, and C-16 Engines)

The “Total Information” column facilitates access to the “Driver Trip”, “Fleet Trip”, and “Lifetime Totals” columns. Press the Down arrow button on the “Totals Information” title screen in order to access the three totals.

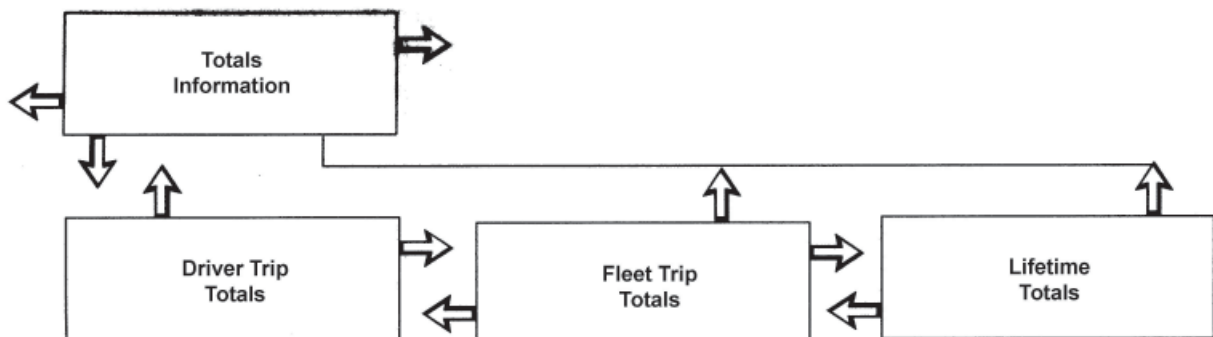

Figure 11 - “Totals Information Column”

### 5-2.5.4 Fleet Trip Segment

The information is intended for the fleet owner or owner driver. The ability to reset the information from the Messenger display depends on the software program. The Fleet Trip Segment may be reset with the electronic service tool and the appropriate passwords. Resetting the Fleet Trip Segment does not affect the Driver Trip Segment or the Lifetime Totals. The Fleet Trip Segment is shown on the Messenger screen map. The Messenger display provides the capability to enter the information for two drivers for the Fleet Trip Segment. The Messenger display provides the driver with the capability to enter the current state. The information on the state is part of the Fleet Trip Segment. The Messenger display provides the capability to enter the information for two drivers for the Fleet Trip Segment. The Fleet Trip Segment can be sorted for the two drivers by the Messenger software. The information on the state is shown on the screen map for the Messenger display. Entering the State Cross and DRIVER ID is explained further in this manual. Resetting the Fleet Trip Segment will clear the Fleet Trip DRIVER IDs. Resetting the Fleet Trip Segment will clear the Fleet Trip State Totals.

### 5-2.5.5 Driver Trip Segment

The Driver Trip Segment is intended for the driver and the Driver Trip segment is controlled by the driver. The Driver Trip Totals are shown on the screen map for the Messenger display in column 2. Resetting the Driver Trip Segment does not affect the Fleet Trip Segment or Lifetime Totals. Resetting the Driver Trip Segment does not affect the State Totals or the DRIVER IDs.

### 5-2.5.6 Example of Trip Segments and Lifetime Totals

The “Explanation of Trip Segment” shows the effect of entering the State Crossing, DRIVER ID, Fleet Trip Segment, and the Driver Trip Segment.

Table 4 - Example of the Trip Segment

Miles	Event	Driver Totals	Mileage Totals
0	New engine	“DRIVER ID1=0 miles” “DRIVER ID2=0 miles”	0
500	“State crossing entered”	“DRIVER ID1=500 miles” “DRIVER ID2=0 miles”	“State 1=500 miles”
1000	“DRIVER ID2 entered as driver”	“DRIVER ID1=1000 miles” “DRIVER ID2=0 miles”	“State 1=500 miles” “State 2=500 miles”
2000	“State crossing entered”	“DRIVER ID1=1000 miles” “DRIVER ID2=1000 miles”	“State 1=500 miles” “State 2=1500 miles” “State 3=0 miles”
2800	“Driver trip segment reset”	“DRIVER ID1=1000 miles” “DRIVER ID2=1800 miles”	“State 1=500 miles” “State 2=1500 miles” “State 3=800 miles”
3300	“DRIVER ID1 entered as driver”	“DRIVER ID1=1000 miles” “DRIVER ID2=2300 miles”	“State 1=500 miles” “State 2=1500 miles” “State 3=1300 miles”
3800	“State crossing entered”	“DRIVER ID1=1500 miles” “DRIVER ID2=2300 miles”	“State 1=500 miles” “State 2=1500 miles” “State 3=1800 miles”
5000	“Fleet trip segment reset” “DRIVER ID’s cleared-must be re-entered.”	“DRIVER ID1=2700 miles” “DRIVER ID2=2300 miles”	“State 1=500 miles” “State 2=2700 miles” “State 3=1800 miles”

Table 5 - Example of the Trip Segment

Miles	“Driver Trip Miles”	“Fleet Trip Miles”	“Lifetime Trip Miles”
0	0	0	0
500	500	500	500
1000	1000	1000	1000
2000	2000	2000	2000
2800	0	2800	2800
3300	500	3300	3300
3800	1000	3800	3800
5000	2200	0	5000



**NOTE:** The fleet trip segment includes State Information and DRIVER ID information.

Table 6 - "Trip Segment Example"

Miles	Description
500	A state crossing is entered and the vehicle operation is now recorded for State 2. The data for State 1 is stored.
1000	Driver 2 begins driving and the vehicle operation is now recorded for Driver 2. The data for Driver 1 is stored.
2000	A third state crossing is entered and the vehicle operation is now recorded for State 3. The data for State 1 and State 2 is stored.
2800	The Driver Trip Segment is reset. The Fleet and "Lifetime" information is not affected.
3300	Driver 1 returns as the driver. New information is now added to the previous Driver 1 records. The records for Driver 2 are stored.
3800	The vehicle has re-entered State 2. Operational information is now added to the State 2 records. The information for State 1 and State 3 are still stored.
5000	The Fleet Trip is reset. This clears the State and DRIVER ID records. Driver Trip and Lifetime Totals are unaffected.

## 5-2.6 The Driver Totals Information for the 3176B, 3176C, 3406E, C-10, C11, C-12, C13, C15, C-15, and C-16 Engines

The Driver Trip Segment is set by the driver. The driver sets the point to begin and the driver sets the point to end. The procedure is similar to setting a trip odometer. The Driver Trip Segment Totals are independent of the DRIVER ID. If a new driver begins operating the vehicle, resetting the DRIVER ID will not reset the Driver Trip Segment. The screen for the Driver Trip segment has ten parameters. The parameters are "Average Fuel Economy", "Distance Traveled", "Average Speed", "Fuel Used", "Engine Run Hours", "PTO Fuel Used", "PTO Hours", "Idle Fuel Used", "Idle Hours", and "Percent Idle Time".

### 5-2.6.1 Accessing the Driver Trip Screens

The display may be moved Up or Down from Column 2 of the screen map from any of the Driver Trip Screens. The "FLEET TRIP" screen may also be navigated in the same way as the "DRIVER TRIP" screen. The Down, Up, and Right arrow buttons are available from any of the "DRIVER TRIP DATA" screens. Moving to the corresponding "FLEET TRIP" information allows the driver to compare current "DRIVER TRIP" data to "FLEET TRIP" data. The desired screen should be selected prior to driving.

Table 7 - Driver Trip Screens

Screen	Parameter	Description
Driver Trip Totals	“Drive Trip Totals” Screen	<ul style="list-style-type: none"> <li>- “Down arrow-View Driver Trip Data.”</li> <li>- “Left arrow-Moves one column to the left.”</li> <li>- “Right arrow-Moves one column to the right.”</li> </ul>
“DRV - AVG MPG”	“Driver Trip Segment” “Average Fuel Economy”	<ul style="list-style-type: none"> <li>- “Shows Driver Trip Average Fuel Economy.”</li> <li>- “Right arrow-Fleet Trip Average Fuel Economy.”</li> <li>- “Down arrow-Driver Trip Distance Traveled and Average Vehicle Speed.”</li> <li>- “Up arrow-DRIVER TRIP TOTALS title screen.”</li> </ul>
“DRV - MI” “AVG - MPH”	“Driver Trip Segment Distance Traveled” “Driver Trip Segment Average Vehicle Speed”	<ul style="list-style-type: none"> <li>- “Shows Distance Traveled for the current Driver Trip Segment. Shows Average Vehicle Speed for the current Driver Trip Segment.”</li> <li>- “Up arrow-Driver Trip Average Fuel Economy screen.”</li> <li>- “Down button-Driver Trip Segment Fuel Used and Engine Hours.”</li> <li>- “Right arrow-Fleet Trip Distance Traveled and Average Speed.”</li> </ul>
“DRV - GAL” “HR”	“Driver Trip Segment Fuel Used” “Driver Trip Segment Engine Hours”	<ul style="list-style-type: none"> <li>- “Shows fuel used during the current Driver Trip Segment. Shows Driver Trip Segment Engine Hours.”</li> <li>- “Up arrow-Driver Trip Segment Distance and Average Vehicle Speed.”</li> <li>- “Down arrow-Driver Trip Segment PTO Fuel and PTO Time.”</li> <li>- “Right arrow-Fleet Trip Fuel and Engine Hours.”</li> </ul>
“DRV - GAL” “PTO” “HR”	“Driver Trip Segment PTO Fuel Used” “Driver Trip Segment PTO Time”	<ul style="list-style-type: none"> <li>- “Shows PTO fuel during the current Driver Trip Segment. Shows Driver Trip Segment PTO time.”</li> <li>- “Up arrow-Driver Trip Segment Fuel Used and Engine Hours.”</li> <li>- “Down arrow-Driver Trip Percent Idle Time.”</li> <li>- “Right arrow-Fleet Trip Idle Fuel and Idle Hours.”</li> </ul>
“DRV - GAL” “IDLE” “HR”	“Driver Trip Segment Idle Fuel Used” “Driver Trip Segment Idle Time”	<ul style="list-style-type: none"> <li>- “Shows Idle Fuel during the current Driver Trip Segment. Shows Driver Trip Segment Idle Time.”</li> <li>- “Up arrow-Driver Trip Segment Fuel Used and Engine Hours.”</li> <li>- “Down arrow-Driver Trip Segment Idle Fuel and Idle Time.”</li> <li>- “Right arrow-Fleet Trip PTO Fuel and PTO Hours.”</li> </ul>
“DRV - IDLE” “%”	“Driver Percent Idle Time”	<ul style="list-style-type: none"> <li>- “A value for the percent of time the driver was idling, calculated from: (Driver Idle Hours divided by Total Driver Hours).”</li> <li>- “Right arrow-Fleet Percent Idle Time.”</li> <li>- “Up arrow-Driver Trip Segment Idle Fuel and Idle Time.”</li> <li>- “Down arrow-Driver Trip Reset screen.”</li> </ul>
“DRV - RESET” “TRIP TOTALS”	“Driver Trip Reset”	<ul style="list-style-type: none"> <li>- “To reset the Driver Trip Segment, press the Left arrow button.”</li> <li>- “Up arrow-Driver Trip Percent Idle Time.”</li> <li>- “Down arrow-Driver Trip Segment title screen.”</li> </ul>
“DRIVER TRIP” “RESET PERFORMED”	“Driver Trip Reset Completed”	<ul style="list-style-type: none"> <li>- “Indicates the Driver Trip Segment has been reset.”</li> <li>- “Pressing any buton will return display to the Driver Trip Segment title screen.”</li> </ul>

### 5-2.6.2 “Fleet Trip Totals” Screens

The screen for the Fleet Trip Segment has ten parameters. The parameters are “Average Fuel Economy”, “Distance Traveled”, “Average Speed”, “Fuel Used”, “Engine Run Hours”, “PTO Fuel Used”, “PTO Hours”, “Idle Fuel Used”, “Idle Hours”, and “Percent Idle Time”. The information for the Fleet Trip Segment is controlled by the fleet owner. The information may be controlled by the driver if the ECM has been programmed to allow the driver to reset the display on the Fleet Trip Segment.

### 5-2.6.3 Accessing the “Fleet Trip” Screens

The display may be moved Up or Down from any of the “Fleet Trip” Screens. The “Driver Trip” screen and the “Lifetime Total” screen may also be navigated in the same way as the “Fleet Trip” screen. The Left Down, Up, and Right arrow buttons are available from any of the “Fleet Trip Data” screens. Moving to the corresponding “Driver Trip Segment” or “Lifetime Total” information allows the driver to compare current “Fleet Trip Data” to the “Driver Trip” data or “Lifetime Total data. The desired screen should be selected prior to driving.

### 5-2.6.4 Reset Protection of Fleet Trip Totals

The “Fleet Trip Totals” may be reset with the Messenger display or the “Fleet Trip Totals” may be reset with an electronic service tool by the Fleet Owner. Resetting is controlled by a Customer Programmable Parameter that is programmed into the engine ECM by the Fleet Owner. The parameter must first be programmed into the ECM. The power to the display must be turned OFF and ON In order for the display to recognize the change.

#### Fleet Owner Control for Reset of the Fleet Trip Segment

The Fleet Trip Reset may be controlled by the Fleet Owner. The display may be reset with Caterpillar Fleet Information Software or with an electronic service tool.

#### ECM Allows the Messenger Display to Reset the Fleet Trip Segment

The Fleet Trip Reset may be controlled by the driver. The display is reset with the dash display, with Caterpillar Fleet Information Software, or with an electronic service tool.

#### All Data Has Been Cleared and the Fleet Trip Segment is Reset

A Fleet Trip Reset will clear all “Fleet Trip Totals”, “Fleet Trip State Totals”, “DRIVER ID”, and “State Crossings”. No other information is affected.

Table 8 - “Fleet Trip” Screens

Screen	Parameter	Description
“FLEET TRIP TOTALS”	“Fleet Trip Totals Title Screen”	<ul style="list-style-type: none"> <li>– “Down arrow-View Fleet Trip Fuel Economy Data.”</li> <li>– “Left arrow-Moves one column to the left.”</li> <li>– “Right arrow-Moves one column to the right.”</li> </ul>
“FLT” “AVG-MPG”	“Fleet Trip Segment Average Fuel Economy”	<ul style="list-style-type: none"> <li>– “Shows average fuel economy and distance traveled during the current Fleet Trip Segment.”</li> <li>– “Left arrow-Driver Trip Average Fuel Economy.”</li> <li>– “Right arrow-Lifetime Average Fuel Economy.”</li> <li>– “Down arrow-Fleet Trip Fuel Used and Gallons Used Per Hour.”</li> <li>– “Up arrow-Fleet Trip Totals title screen.”</li> </ul>
“FLT” “AVG - MPH”	“Fleet Trip Segment Average Speed”	<ul style="list-style-type: none"> <li>– “Shows average vehicle speed during the current Fleet Trip Segment.”</li> <li>– “Left arrow-Driver Trip Average Speed.”</li> <li>– “Right arrow-Lifetime Average Speed.”</li> <li>– “Down arrow-Fleet Fuel Used and Engine Hours during current trip.”</li> <li>– “Up arrow-Fleet Trip Fuel Economy title screen.”</li> </ul>

Table 8 - "Fleet Trip" Screens - Continued

Screen	Parameter	Description
"FLT - GAL - HR"	"Fleet Trip Segment Fuel Used" "Fleet Trip Segment Engine Hours"	<ul style="list-style-type: none"> <li>- "Shows Fuel Used during the current Fleet Trip Segment. Shows Fleet Trip Segment Engine Hours."</li> <li>- "Left arrow-Driver Trip Segment Fuel Used and Engine Hours."</li> <li>- "Right arrow-Lifetime Fuel Used and Engine Hours."</li> <li>- "Up arrow-Fleet Trip Segment Fuel Used Per Hour."</li> <li>- "Down arrow-Fleet Trip Segment PTO Fuel and PTO Time."</li> </ul>
"FLT - GAL" "PTO" "HR"	"Fleet Trip Segment PTO Fuel Used" "Fleet Trip Segment PTO Time"	<ul style="list-style-type: none"> <li>- "Shows PTO fuel during the current Driver Trip Segment. Displays Fleet Trip Segment PTO time."</li> <li>- "Left arrow-Driver Trip Segment PTO Time and PTO Fuel Used."</li> <li>- "Right arrow-Lifetime PTO Time and PTO Fuel Used."</li> <li>- "Up arrow-Fleet Fuel Used and Engine Hours during current trip."</li> <li>- "Down arrow-Fleet Trip Segment Idle Fuel and Idle Time."</li> </ul>
"FLT - GAL" "IDLE" "HR"	"Fleet Trip Segment Idle Fuel Used" "Fleet Trip Segment Idle Time"	<ul style="list-style-type: none"> <li>- "Shows Idle Fuel Used during the current Fleet Trip Segment. Shows Fleet Trip Segment Idle Time."</li> <li>- "Left arrow-Driver Trip Segment Idle Time and Idle Fuel Used."</li> <li>- "Right arrow-Lifetime Idle Time and Idle Fuel Used."</li> <li>- "Up arrow-Fleet Trip Segment PTO Fuel and PTO Hours."</li> <li>- "Down arrow-Fleet Percent Idle Time."</li> </ul>
"FLT - IDLE" "%"	"Fleet Percent Idle Time"	<ul style="list-style-type: none"> <li>- "A value for the percent idle time of the fleet, calculated from: (Fleet Idle Hours divided by Total Fleet Hours)."</li> <li>- If the 3176B, 3176C, 3406E, C-10, C11, C-12, C13, C15, C-15 and C-16 engine ECM has been programmed to allow the Fleet Trip Reset, the Down button displays the "Fleet Trip Reset" screen. If the Fleet Trip Reset has not been programmed, the Down button returns to the "Fleet Trip" title screen.</li> <li>- "Left arrow-Driver Percent Idle Time."</li> <li>- "Right arrow-Lifetime Percent Idle Time."</li> <li>- "Up arrow-Fleet Trip Segment Idle Fuel and Idle Time."</li> </ul>
"FLT RESET" "TRIP TOTALS"	"Fleet Trip Reset"	<ul style="list-style-type: none"> <li>- "To Reset the Fleet Trip Segment, press the Left arrow button."</li> <li>- "Up arrow-Fleet Trip Percent Idle Time."</li> <li>- "Down arrow-FLEET TRIP SEGMENT title screen."</li> <li>- (f the 3176B ECM, 3176C ECM, 3406E ECM, C-10 ECM, C11 ECM, C-12 ECM, C13 ECM, C15 ECM, C-15 ECM, or the C-16 ECM has not been programmed to allow the Fleet Trip Reset by the driver, this screen is not available.)</li> </ul>
"FLEET TRIP" "RESET PERFORMED"	"Fleet Trip Reset Completed"	<ul style="list-style-type: none"> <li>- "Indicates the Fleet Trip Segment has been reset. Pressing any button will return display to the FLEET TRIP SEGMENT title screen." (The 3176B ECM, 3176C ECM, 3406E ECM, C-10 ECM, C11 ECM, C-12 ECM, C13 ECM, C15 ECM, C-15 ECM, or the C-16 ECM must be programmed in order to allow the "Fleet Trip Reset" by the driver.)</li> </ul>

### 5-2.6.5 "Lifetime Totals" Screens

The screen for the "Lifetime Totals" has ten parameters. The parameters are "Average Fuel Economy", "Distance Traveled", "Average Speed", "Fuel Used", "Engine Run Hours", "PTO Fuel Used", "PTO Hours", "Idle Fuel Used", "Idle Hours", and "Percent Idle Time". This information is maintained by the engine ECM for the life of the engine.

### 5-2.6.6 Accessing The Lifetime Totals Screens

The display may be moved Up or Down from Column 2 of the screen map from any of the Lifetime Totals Screens. The “Driver Trip” screen and the “Lifetime Total” screen may be navigated in the same way as the “Fleet Trip” screen when the vehicle has the 3176B, 3176C, 3406E, C-10, C11, C-12, C13, C15, C-15, or C-16 engines. The Left, Down, Up, and Right arrow buttons are available from any of the “Lifetime Totals Data” screens. Moving to the corresponding “Fleet Trip” information allows the driver to compare current “Lifetime Totals” to the “Fleet Trip” data. The desired screen should be selected prior to driving.

Table 9 - “Lifetime” Screens

Screen	Parameter	Description
“LIFETIME TOTALS”	“Lifetime Totals Title Screen”	<ul style="list-style-type: none"> <li>– “Down arrow-View Lifetime Totals Data.”</li> <li>– “Left arrow-Moves one column to the left.”</li> <li>– “Right arrow-Moves one column to the right.”</li> </ul>
“LFT” “AVG MPG”	“Lifetime Total Segment” “Average Fuel Economy”	<ul style="list-style-type: none"> <li>– “Shows Lifetime Total Average Fuel Economy.”</li> <li>– “Left arrow-Fleet Trip Average Fuel Economy.”</li> <li>– “Down arrow-Lifetime Total Fuel Used and Engine Hours.”</li> <li>– “Up arrow-Lifetime Totals title screen.”</li> </ul>
“LIF MI” “AVG MPH”	“Lifetime Mileage” “Lifetime Average Speed”	<ul style="list-style-type: none"> <li>– “Shows Distance Traveled for the engine to date. Shows Average Vehicle Speed for the engine to date.”</li> <li>– “Left arrow-Fleet Trip Segment Distance Traveled and Average Vehicle Speed.”</li> <li>– “Up arrow-Lifetime total miles and average fuel economy screen.”</li> <li>– “Down arrow-Lifetime Total Fuel Used and Gallons per Hour.”</li> </ul>
“LIF - GAL - HR”	“Lifetime Total Fuel Used” “Lifetime Total Segment Engine Hours”	<ul style="list-style-type: none"> <li>– “Shows Fuel Used for the engine to date. Shows Engine Hours for the engine to date.”</li> <li>– “Left arrow-Fleet Trip Segment Fuel Used and Engine Hours.”</li> <li>– “Up arrow-Lifetime Total Fuel and Hours.”</li> <li>– “Down arrow-Lifetime Total PTO Fuel and PTO Time.”</li> </ul>
“LIF PTO GAL” “PTO HR”	“Lifetime Total PTO Fuel Used” “Lifetime Total PTO Time”	<ul style="list-style-type: none"> <li>– “Shows Fuel Used for the engine to date. Shows Engine Hours for the engine to date.”</li> <li>– “Left arrow-Fleet Trip Segment Fuel Used and Engine Hours.”</li> <li>– “Up arrow-Lifetime Total Distance and Average Vehicle Speed.”</li> <li>– “Down arrow-Lifetime Total PTO Fuel and PTO Time.”</li> </ul>
“LIF IDLE GAL” “HR”	“Lifetime Total Idle Time” “Lifetime Total Idle Fuel Used”	<ul style="list-style-type: none"> <li>– “Shows Idle Fuel Used for the engine to date. Shows Idle Time for the engine to date.”</li> <li>– “Left arrow-Fleet Trip Segment Idle Time and Idle Fuel Used.”</li> <li>– “Up arrow-Lifetime Total PTO Fuel Used and PTO Hours.”</li> <li>– “Down arrow-Lifetime percent idle time screen.”</li> </ul>
“LIF IDLE” “%”	“Lifetime Percent Idle Time”	<ul style="list-style-type: none"> <li>– “Shows a value for the percent of total operating time idling, calculated from: (Lifetime Idle Hours divided by Total Lifetime Hours).”</li> <li>– “Left arrow-Fleet Percent Idle Time.”</li> <li>– “Up arrow-Lifetime Total Idle Fuel and Idle Time.”</li> <li>– “Down arrow-LIFETIME TOTALS title screen.”</li> </ul>



## 5-2.7 “Fleet Trip State Totals” Screens

### 5-2.7.1 The 3176B, 3176C, C-10, C11, C-12, C13, C15, C-15, C16, and 3406E Engines only

The ECM for the Caterpillar 3176B, 3176C, C-10, C11, C-12, C13, C15, C-15, C-16 and 3406E will store the data for the distance that is driven, the total fuel consumption number, the idle fuel that has been used, and the PTO fuel that has been used for each state. More than one state may be selected during a “Fleet Trip Segment” up to a maximum of 50 states. Before the data is stored, the current state must be entered into the display.

### 5-2.7.2 Accessing “Fleet Trip State Totals”

ECM Customer Programmable parameters determine the access to this function of the display. If the “State Information” is programmed OFF in the ECM, the entire “Fleet Trip State Totals” column will not be shown. Press the Right arrow button of the “LIFETIME TOTALS” screen. This will cause the display to skip the “FLEET TRIP STATE TOTALS” screen. Press the Left arrow button of the “MAINTENANCE DATA” title screen. This will cause the display to skip the “FLEET TRIP STATE TOTALS” title screen.

After programming the parameters in the ECM, the power must be turned OFF and the power turned ON again in order for the display to recognize the change.

Table 10 - “Fleet Trip State Totals” Screens

Screen	Parameter	Description
“FLEET TRIP STATE TOTALS”	“Fleet Trip State Totals Title Screen”	<ul style="list-style-type: none"> <li>– The Down arrow button selects a state and the data for that state.</li> <li>– If “State Crossing” has not been entered, the message “NO SELECTIONS AVAILABLE” will appear.</li> <li>– Press any button in order for the display to return to the “FLEET TRIP STATE TOTALS” title screen.</li> <li>– From the title screen, the Left arrow button moves to the “LIFETIME TOTALS” title screen. The Right arrow button moves to the “MAINTENANCE DATA” title screen.</li> </ul>
“STATE 1”	“Select A State To View State Trip Data”	<ul style="list-style-type: none"> <li>– Press the Left arrow button in order to begin viewing “Fleet Trip State” information.</li> <li>– Press the Down arrow button in order to view other states, if other states are available.</li> <li>– If more than one state is available, use the Down and Up arrow buttons to review the list of states with recorded data.</li> </ul>
“STATE 1” “MI”	“Fleet Trip State Distance Traveled For Selected State”	<ul style="list-style-type: none"> <li>– The display shows the distance that has been driven in the selected state for the current “Fleet Trip”.</li> <li>– The selected state will be shown as “State 1”.</li> <li>– The Up arrow button returns to “STATE SELECTION” screen.</li> <li>– The “Down” arrow button will display the fuel that has been used in the selected state.</li> </ul>
“STATE 1” “GAL”	“Fleet Trip State Fuel Used For Selected State”	<ul style="list-style-type: none"> <li>– The display shows the “Fuel Used” in a selected state for the current “Fleet Trip”.</li> <li>– The selected state will be shown as “State 1”.</li> <li>– The Up arrow button returns to “STATE DISTANCE TRAVELED” screen.</li> <li>– The Down arrow button displays “PTO Fuel Used” in the selected state.</li> </ul>
“STATE 1” “PTO GAL”	“Fleet Trip State PTO Fuel Used For Selected State”	<ul style="list-style-type: none"> <li>– The display shows the “PTO Fuel Used” in a selected state for the current “Fleet Trip”.</li> <li>– The selected state will be shown as “State 1”.</li> <li>– The Up arrow button returns to “Fuel Used” for this state.</li> <li>– The Down arrow button displays “Idle Fuel Used” in the state that is selected.</li> </ul>
“STATE 1” “IDLE GAL”	“Fleet Trip State Idle Fuel Used For Selected State”	<ul style="list-style-type: none"> <li>– The display shows the “Idle Fuel Used” in a selected state for current “Fleet Trip”.</li> <li>– The selected state will be shown as “State 1”.</li> <li>– The Up arrow button returns to the “PTO Fuel Used” for this state.</li> <li>– The Down arrow button returns the display to the screen that shows the state that is selected, in this example “State 1”.</li> </ul>

## 5-2.8 “Economy Model” Screens

### 5-2.8.1 Information for the 3176B, 3176C, 3406E, C-10, C11, C-12, C13, C15, C-15, and C-16 Engines

The Messenger display can display information regarding the “Economy Model” feature of the ECM. This information includes the current “Driver Bonus” and this information includes the current “Target vs. Actual” totals. Refer to the “Screen Maps” of the Messenger display for additional information.

Table 11 - “Economy Model” Screens

Screen	Parameter	Description
THE REWARD IS ACTIVE OR THE REWARD IS NOT ACTIVE.	The Reward is not active.	– This screen will indicate if the reward is active and the driver “VSL bonus” is active. The reward will be active if the overall Driver Incentive score is above the programmed threshold score.
	The Reward is active.	– If the reward is active, the second line of the display will indicate the current “Driver Bonus” reward that is available.
“TARGET SCORE XXX” “ACTUAL SCORE XXX”	“Target vs. Actual” “XXX”	<ul style="list-style-type: none"> <li>– The screen will display the threshold score. This is referred to as the target score. This may be viewed on the top line.</li> <li>– The bottom line of the display will indicate the current overall “actual score”.</li> <li>– If the “actual score” is higher than the target score, the reward will be active and the driver will receive a “Driver Bonus”.</li> </ul>
“AVG ENGINE SPEED (RPM)”	“Parameter Information Screens” “Average Engine Speed (RPM)” “Average Driving Speed Over 50 MPH” “Average Throttle Demand (RPM)” “Average Shift Engine Speed (RPM)” “Percent Idle Time”	<ul style="list-style-type: none"> <li>– The driver can use the screens for parameter information to obtain information on each of the five parameters of the “Economy Model” feature. As an example, follow the steps in order to obtain information on “Percent Idle Time”.               <ol style="list-style-type: none"> <li>a. Press the Down arrow button to the “PERCENT IDLE TIME” screen.</li> <li>b. Press the Left arrow button.</li> <li>c. View the specific information on “target vs. Actual Percent Idle Time Values”.</li> <li>d. Press the Left arrow button in order to view the “SCORE” screen.</li> </ol> </li> </ul> <p>The “score” is shown on the screen as “XXX” of “YYY”. “XXX” is the actual “score” and “YYY” is the maximum “score” for that parameter. The maximum “score” will depend on the parameter value in the ECM.</p>

## 5-2.9 “Maintenance Data” Screens

The display can indicate the service history for the maintenance that was performed on the oil and the oil filter (PM1). The display may indicate when the next scheduled PM 1 maintenance is due. The maintenance data is displayed in distance or hours. This is determined by the Customer Programmable Parameters that are programmed into the ECM. The ECM can be programmed to the OFF position, which will prevent the recording of maintenance data from the ECM. After programming the parameters in the ECM, the power must be turned OFF and the power turned ON again in order for the display to recognize the change.

Table 12 - “Maintenance” Screens

Screen	Parameter	Description
“MAINTENANCE DATA”	“Maintenance Data title screen” The Reward is active.	Press the Down arrow button in order to view maintenance data. Press the Left arrow button in order to move one column to the left. Press the Right arrow button in order to move one column to the right.
PM 1-DUE “MI or HR”	PM 1 “Maintenance Due Data”	The display shows when the PM 1 Maintenance should next be performed. This screen will be shown automatically when the display is first turned on and the PM 1 maintenance is due within 3000 miles or 60 hours. This screen will be viewed until an arrow button is pressed. Press the Down arrow button in order to view the maintenance interval and the last performed maintenance interval. Press the Up arrow button in order to view the “MAINTENANCE DATA” title screen. The display will show “PM 1 Disabled” on this screen if the ECM has not been programmed to record PM 1.
PM 1 “RANGE” “MI or HR” “LAST” “MI or HR”	PM 1 “Maintenance Due Data”	This screen shows the PM 1 Maintenance Interval. The screen also shows the previous PM 1 Maintenance that was performed. Press the Up arrow button in order to return to the screen that indicates when the next PM 1 Maintenance is due. This may be performed if the 3176B, 3176C, C-10, C11, C-12, C13, C15, C-15, C-16, or 3406E has been programmed to allow the PM 1 Maintenance Data to be reset from the display. Press the Down arrow button in order to display the “MAINTENANCE DATA RESET” screen. Press the Down arrow button in order to return to the “Maintenance Data” title screen. This may be performed if the 3176B, 3176C, C-10, C11, C-12, C13, C15, C-15, C-16 or 3406E has been programmed to not allow the PM 1 Maintenance Data to be reset from the display.
PM 1 “RESET”	PM 1 “Maintenance”	Press the Left arrow button in order to reset the PM 1 Maintenance Data. Press the Up arrow button in order to view the PM 1 Maintenance Interval. Press the Up arrow button in order to view the PM 1 Maintenance screen. Press the Down arrow button in order to view the “Maintenance Data” title screen.
PM 1 “RESET PERFORMED”	PM 1 “Maintenance Reset Completed”	This screen indicates that PM 1 has been successfully reset. Press any button in order to return to the “MAINTENANCE DATA” title screen.
PM 1 “PAST DUE” “MI or HR”	PM 1 “Maintenance Overdue”	This screen indicates that the PM 1 maintenance interval has been exceeded without a reset. This message will be shown when the display is first turned On. This message will be shown when PM 1 is On. This message will be shown when PM 1 maintenance is due within 3000 miles or maintenance is due within 60 hours. This screen will also be shown if the maintenance interval has been exceeded.

## 5-2.10 Diagnostic Data” Screens

The display will automatically indicate certain diagnostic codes as the codes occur. The “DIAGNOSTIC DATA” screens provide the advantage of indicating the reason that the Check Engine lamp has come on. The codes will be displayed with the PID-FMI diagnostic code (Parameter Identifier and Failure Mode Identifier) and a brief text description. If more than one code is active, pressing the Down arrow button will scroll through the remaining codes. An active diagnostic code that becomes inactive will disappear from the screen. Press the Right arrow button in order to return to the title screen. The display will indicate other codes or “No Active Codes”.

Table 13 - Automatically Displayed Diagnostic Codes

PID-FMI	“Code Description”
100-11	“Very Low Oil Pressure”
110-11	“Very High Coolant Temperature”
111-11	“Very Low Coolant Level”
100-01	“Low Oil Pressure Warning”
110-00	“High Coolant Temperature Warning”
111-01	“Low Coolant Level Warning”
105-00	“High Inlet Manifold Temp Warning”
105-11	“Very High Inlet Manifold Temp”

The diagnostic codes in the above table (table 13) will be displayed whenever the codes are active. The display will continue to show these codes until any button is pressed. The display will continue to show these codes until the diagnostic goes from an active state to an inactive state. If no other codes are active, the Messenger display will return to the screen that was displayed before the diagnostic event.

The diagnostic codes may alert the driver to conditions that may damage engine components. The diagnostic codes 100-11 “Very Low Oil Pressure”, 111-11 “Very Low Coolant Level”, and 110-11 “Very High Coolant Temperature” indicate that the engine is experiencing a serious problem.



**NOTE:** Depending on the engine configuration, the engine may shut down when a potentially serious engine problem diagnostic code becomes active. The driver will be provided a warning before engine shutdown.

### 5-2.10.1 Procedure to Address the Occurrence of Codes

Whenever a diagnostic code occurs, try to note all operating conditions of the vehicle. It is especially critical to take note of the operating conditions for intermittent codes. This information provides the technicians with the operating conditions at the time of the intermittent code. This will enhance the technician’s ability to produce the code again. This will also enhance the technician’s ability to diagnose the problem. The codes are recorded in the ECM and the codes may be recovered with the electronic service tool.

### 5-2.10.2 Diagnostic Code Chart

The following table (Table 14) is provided in order to help determine the action that should be taken if a particular diagnostic code is active. The chart is intended as a general guideline. The current operating conditions will determine the reaction of the driver to the codes. As an example, only intermittent service codes that are a persistent problem should be serviced.

Table 14 - "Suggested Driver Action for Diagnostic Codes  
(3176B, 3176C, C-10, C11, C-12, C13, C15, C-15, and the 3406E Engines)"

Code	Description	"Shutdown" "Vehicle" (1)	"Service ASAP" (2)	"Schedule Service" (3)
1-11	Cylinder 1 Fault		X	
2-11	Cylinder 2 Fault		X	
3-11	Cylinder 3 Fault		X	
4-11	Cylinder 4 Fault		X	
5-11	Cylinder 5 Fault		X	
6-11	Cylinder 6 Fault		X	
22-11	"Cam Sensor to Crank Sensor Calibration"			X
22-13	"Check Timing Sensor Calibration"			X
30-08	Invalid PTO Throttle Signal			X
30-13	"PTO Throttle Sensor Calibration"			X
32-05	"Turbo Wastegate Solenoid Output Open Circuit"		X	
32-06	"Turbo Wastegate Solenoid Short Circuit"		X	
32-11	"Turbo Wastegate Solenoid Output Short to +Batt"		X	
41-03	"8 Volt Supply Above Normal"		X	
41-04	"8 Volt Supply Below Normal"		X	
43-02	"Ignition Button Switch Fault"		X	
52-11	"Air Inlet Shutoff Shutdown"			X
54-05	"Output #6 Open Circuit"		X	
54-06	"Output #6 Short Circuit"		X	
55-05	"Output #7 Open Circuit"		X	
55-06	"Output #76 Short Circuit"		X	
64-12	"Loss of Engine Cam Sensor RPM Signal"			X
71-00	"Idle Shutdown Override" (4)			
71-01	"Idle Shutdown Occurrence" (4)			
71-14	"PTO Shutdown Timer Occurrence"			X
84-00	"Vehicle Over Speed Warning" (4)			
84-01	"Loss of Vehicle Speed Signal"			X
84-02	"Invalid Vehicle Speed Signal"			X
84-08	"Vehicle Speed Out of Range"			X
84-01	"Vehicle Speed Rate of Change"			X

(1) The "Shutdown Vehicle" code indicates the presence of a condition that could potentially damage the engine. The driver should bring the vehicle to a stop off the road and out of traffic.

(2) The "Service ASAP" code indicates that the driver should go to the nearest qualified location for service if vehicle performance is adversely affected.

(3) The "Schedule Service" code should be addressed at the next convenient opportunity if vehicle operation is adversely affected.

(4) "No action required"

Table 14 - "Suggested Driver Action for Diagnostic Codes  
(3176B, 3176C, C-10, C11, C-12, C13, C15, C-15, and the 3406E Engines)" continued

Code	Description	"Shutdown" "Vehicle" <sup>(1)</sup>	"Service ASAP" <sup>(2)</sup>	"Schedule Service" <sup>(3)</sup>
84-14	"Quick Stop Occurrence:" <sup>(4)</sup>			
91-08	"Invalid Throttle Signal"		X	
91-13	"Throttle Sensor Calibration"		X	
100-01	"Low Oil Pressure Warning"		X	
100-03	"Oil Pressure Sensor Open Circuit"			X
100-04	"Oil Pressure Sensor Short Circuit"			X
100-11	"Very Low Oil Pressure"	X		
102-00	"Boost Pressure Reading Stuck High" <sup>(4)</sup>			X
102-01	"Boost Pressure Reading Stuck Low" <sup>(4)</sup>			X
102-02	"Erratic Boost Pressure"		X	
102-03	"Boost Pressure Sensor Open Circuit"			X
102-04	"Boost Pressure Sensor Short Circuit"			X
102-07	"Excessive Boost Pressure"		X	
103-00	"High Turbo Speed Derate"		X	
103-11	"Very High Turbo Speed Derate"		X	
105-00	"High Intake Manifold Air Temperature Warning"		X	
105-03	"Intake Manifold Air Temperature Sensor" "Open Circuit"			X
105-04	"Intake Manifold Air Temperature Sensor" "Short Circuit"			X
105-11	"Very High Intake Manifold Air Temperature"		X	
108-03	"Atmospheric Pressure Sensor Open Circuit"			X
108-04	"Atmospheric Pressure Sensor Short Circuit"			X
110-00	"High Coolant Temperature Warning"		X	
110-03	"Coolant Temperature Sensor Open Circuit"			X
110-04	"Coolant Temperature Sensor Short Circuit"			X
110-11	"Very High Coolant Temperature"	X		
111-01	"Low Coolant Level Warning"		X	
111-02	"Coolant Level Sensor Fault"			X
111-03	"Coolant Level Sensor Open Circuit"			X
111-04	"Coolant Level Sensor Short Circuit"			X
111-11	"Very Low Coolant Level"	X		

(1) The "Shutdown Vehicle" code indicates the presence of a condition that could potentially damage the engine. The driver should bring the vehicle to a stop off the road and out of traffic.

(2) The "Service ASAP" code indicates that the driver should go to the nearest qualified location for service if vehicle performance is adversely affected.

(3) The "Schedule Service" code should be addressed at the next convenient opportunity if vehicle operation is adversely affected.

(4) "No action required"

Table 14 - "Suggested Driver Action for Diagnostic Codes  
(3176B, 3176C, C-10, C11, C-12, C13, C15, C-15, and the 3406E Engines)" continued

Code	Description	"Shutdown" "Vehicle" <sup>(1)</sup>	"Service ASAP" <sup>(2)</sup>	"Schedule Service" <sup>(3)</sup>
111-14	"Early Hour Low Coolant Level"			X
121-05	"Retarder Solenoid Low/High Open Circuit"			X
121-06	"Retarder Solenoid Low/High Short Circuit"			X
122-05	"Retarder Solenoid Med/High Open Circuit"			X
122-06	"Retarder Solenoid Med/High Short Circuit"			X
166-11	"Rated Engine Power Derate"			X
168-02	"Intermittent Battery"		X	
171-03	"Outside Air Temp Sensor Open Circuit"			X
171-04	"Outside Air Temp Sensor Short Circuit"			X
171-11	"No Ambient Air Temperature Data"			X
173-00	"High Exhaust Gas Temperature Derate"		X	
173-03	"Exhaust Gas Temperature Open Circuit"			X
173-04	"Exhaust Gas Temperature Short Circuit"			X
173-11	"Very High Exhaust Gas Temperature Derate"	X		
174-00	"High Fuel Temperature Warning"			X
174-03	"Fuel Temperature Sensor Open Circuit"			X
174-04	"Fuel Temperature Sensor Short Circuit"			X
190-00	"Engine Over Speed Warning" <sup>(4)</sup>			
190-12	"Loss of Engine Crank Sensor RPM Signal"			X
191-07	"Transmission Not Responding"		X	
224-11	"Theft Deterrent Active" <sup>(4)</sup>			
224-14	"Engine Cranking with Theft Deterrent Active" <sup>(4)</sup>			
231-02	"J1939 Required Data Not Received"			X
231-12	"J1939 Device Not Responding"			X
232-03	"5 Volt Supply Above Normal"			X
232-04	"5 Volt Supply Below Normal"			X
246-11	"Brake Switch #1"			X
247-11	"Brake Switch #2"			X
249-11	"J1922 Data Link Fault"			X
252-11	"Incorrect Engine Software"		X	
253-02	"Check Customer or System Parameters"			X
253-11	"Check Transmission Customer Parameters"		X	

(1) The "Shutdown Vehicle" code indicates the presence of a condition that could potentially damage the engine. The driver should bring the vehicle to a stop off the road and out of traffic.

(2) The "Service ASAP" code indicates that the driver should go to the nearest qualified location for service if vehicle performance is adversely affected.

(3) The "Schedule Service" code should be addressed at the next convenient opportunity if vehicle operation is adversely affected.

(4) "No action required"

## 5-2.11 “Theft Deterrent” Screens

### 5-2.11.1 Theft Deterrent

The Messenger display provides the capability to allow the engine to start, the capability to prevent the engine from starting, or the capability to shut down the engine. This may be done by entering a customer password with four characters into the display when the engine is at idle.

In the powerup sequence, the display will indicate if the “Theft Deterrent System” is enabled, automatically enabled, or disabled. The “Theft Deterrent System” may be enabled or the system may be automatically enabled. The engine will not start until the customer password with four characters is successfully entered into the display. If the system is disabled, the engine will start without the password. To enable the system, the customer password must be successfully entered. The passwords that are entered will not be accepted if the engine is not at idle condition. In order to automatically enable the system, the vehicle needs to be shut off in a normal manner. The “Theft Deterrent” parameter needs to be programmed in order to be in the “Automatically Enable” mode.

### 5-2.11.2 “Accessing Theft Deterrent”

ECM Customer Programmable parameters determine the access to this function of the dash display and the Theft Deterrent password. The ECM must be programmed to allow access to this screen. The ECM must be programmed or the entire “Theft Deterrent” column of the screen map will not be shown. Pressing the Right arrow button on the “DIAGNOSTIC DATA” title screen will cause the display to pass over the “THEFT DETERRENT” title screen.

After the parameters are programmed in the ECM, the power must be turned OFF and the power turned ON again in order for the display to recognize the change.

Table 15 - “Theft Deterrent” Entry Screens

Screen	Parameter	Description
“Theft Deterrent Status”	“Theft Deterrent Title Screen”	<p>The screen shows the current status of the “Theft Deterrent” system when “STATUS” text is indicated. The system may be “ENABLED” and the engine will not start until the correct password is entered. The system may be “DISABLED” and the “Theft Deterrent” system is not active. The engine may be started if the “Theft Deterrent” system is “Disabled”.</p> <p>This screen is shown when the display is first powered up and the “Theft Deterrent” system is programmed to be active.</p> <p>Press the Left arrow button in order to move one column to the left.</p> <p>Press the Right arrow button in order to move one column to the right.</p> <p>Press the Down arrow button in order to move to the “ENTER PASSWORD” screen.</p>
“Enter Password” “4 Characters”	“Enter Theft Deterrent Password”	<p>Press the “Up” arrow button or the “Down” arrow button in order to scroll through numbers 0 to 9. Press the “Up” arrow button or the “Down” arrow button in order to scroll through letters A to Z.</p> <p>Press the Right arrow button and the Left arrow button in order to move between locations of the characters.</p>
“4 Characters If Correct”	“Accept Entered Password”	<p>This screen shows the password that has been entered. If the password is correct, the text message “PASSWORD ACCEPTED” will be displayed. The display will then return to the “THEFT DETERRENT” title screen in order to show the status.</p> <p>If the password is not accepted, the following message will be displayed “PASSWORD INCORRECT”.</p> <p>The display will then return to the “THEFT DETERRENT” title screen and the status will not have changed.</p> <p>Press the Left arrow button in order to enter the password.</p> <p>Press the Up, Down, and Right arrow button in order to return the display to the “THEFT DETERRENT” title screen. This will clear the password that was just entered.</p>



## 5-2.12 “Fuel Correction Adjustment” Screens

### 5-2.12.1 The 3176B, 3176C, C-10, C11, C-12, C13, C15, C-15, C-16, and 3406E Engines Only

The “Fuel Correction Adjustment” allows the fine tuning of data on future fuel usage that is based on the past differences of values. The values are stored in the ECM and the recorded fuel usage.

### 5-2.12.2 Accessing “Fuel Correction Adjustment”

An ECM Customer Programmable Parameter determines access to this function of the dash display. If the ECM is not programmed to allow access to this screen, the entire “Fuel Correction Adjustment” column of the “Screen Map” will not be shown. Press the Right arrow button from the “THEFT DETERRENT” title screen or press the Left arrow button from the “DISPLAY CONFIGURATION” title screen in order to pass over the “FUEL CORRECTION ADJUSTMENT” title screen. After the parameters are programmed in the ECM, power to the display must be turned OFF and the power turned ON again in order for the display to recognize the change.

“Fuel Correction Adjustments” should be made following extensive operation of the vehicle. During this period, the vehicle should be operated in the usual manner. The “Fuel Correction Adjustment” affects all future “Fuel Used” data, “Instantaneous”, “Driver Trip”, “Fleet Trip”, and “Lifetime Totals”. The “Fuel Correction Adjustment” should be made when the vehicle is not moving.

### 5-2.12.3 “Adjusting Fuel Correction”

#### Determining Actual Fuel Economy

The actual fuel usage and travel distance must be recorded in order to make an accurate adjustment. The display uses the “Fleet Trip Segment” as a basis for “fuel correction adjustment”. The actual fuel usage and the travel distance should be recorded immediately after a “Fleet Trip Segment Reset”. Calculate the “Actual Fuel Economy” after driving on a typical route for an extended period of time. Calculate the fuel economy from the “Fuel Used” and “Distance Traveled” per the following formula.

$$\frac{\text{Actual Distance Traveled}}{\text{Actual Fuel Used}}$$

#### Entering Actual Fuel Economy

- From the “FUEL CORRECTION ADJUSTMENT” title screen, press the Down arrow button. The display will show the current “Fleet Fuel Economy” on the top line. The display will show a flashing cursor near the left digit next to the word “ACTUAL” on the second line of the display.
- Pressing the Down arrow button scrolls through numbers 0 to 9 beginning with 9. Pressing the Up arrow button begins with the number 1. If the first position is not needed, press the Right arrow button. The space for the second digit will be highlighted. When the appropriate number is viewed, press the Right arrow button and select the digit after the decimal point. When the last digit is successfully selected, press the Right arrow button. The display will indicate the “Actual Fuel Economy” that was entered. If the number is correct, press the Left arrow button.
- If the “Actual Fuel Economy” is correct, press the Left arrow button. A message will appear to verify the “fuel correction adjustment”. If the value for “Actual Fuel Economy” was entered incorrectly, press the Down, Up, or Right arrow button. The display will return to the “FUEL CORRECTION ADJUSTMENT ENTRY” screen. The numbers that were previously entered will be deleted from the screen. The display will allow the value for the “Actual Fuel Economy” to be re-entered on the screen.

#### “Fuel Correction Out-of-Range” Message

The “FUEL CORRECTION OUT OF RANGE” message will be displayed if the value for the “Fuel Rate Correction” exceeded the allowable limits. Press any button in order for the display to return to the “FUEL CORRECTION ADJUSTMENT” title screen.

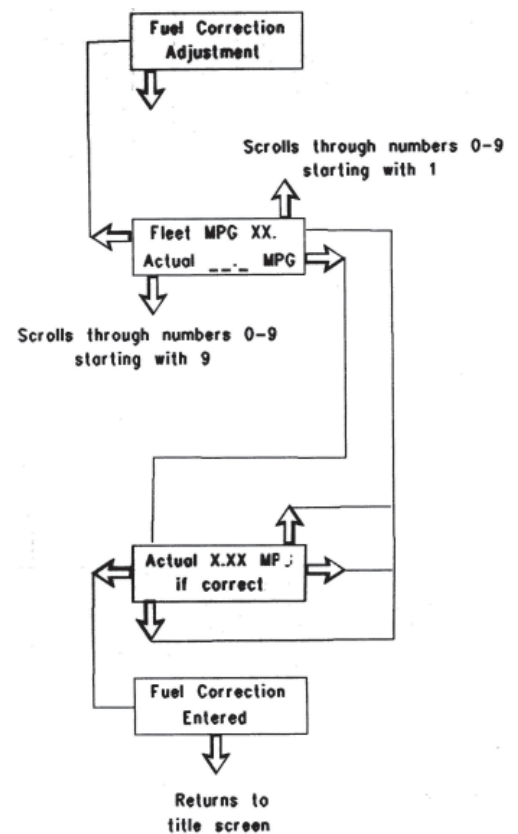

Figure 12

## 5-2.13 “Display Configuration” Screens

The language for the display can be selected by the driver. The three languages are English, French, or Spanish.

The units of measure for the display may be selected by the driver. There are four groups of units:

- English units (“miles”, “US gallons”, “psi”, and “°F”)
- English units (“miles”, “Imperial gallons”, “psi”, and “°F”)
- Metric units (“kilometers/liters”, “kPa”, and “°C”)
- Metric units (“liters/100 kilometers”, “liters”, “kPa”, and “°C”)

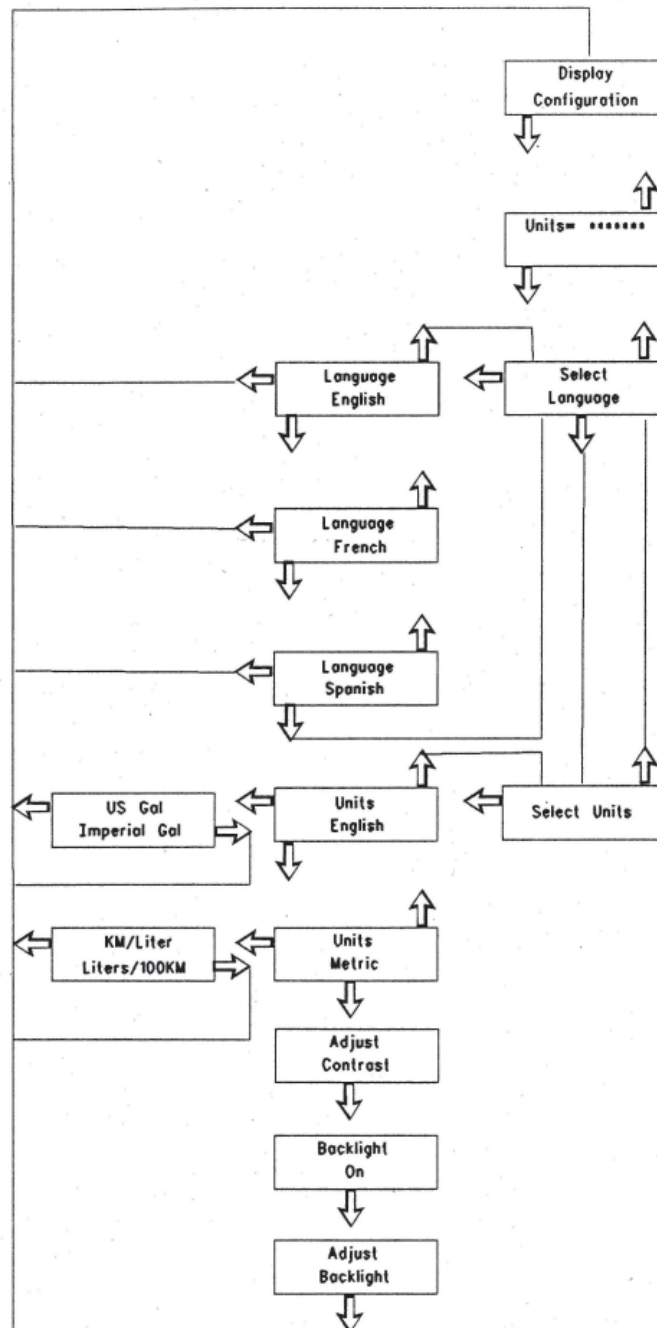

Figure 13 - Seeking Display Units

### 5-2.13.1 Units of Measure

From the “DISPLAY CONFIGURATION” title screen, press the Down arrow button. This screen displays the current units for the measurements.

Select the Display Language from the “DISPLAY CONFIGURATION” title screen. Press the Down arrow button two times. Once the “Select Language” screen appears, press the Left arrow button one time.

If the English language is desired, press the Left arrow button.

Press the Down arrow button from the “English” screen to go to the “French” screen. Now press the Left arrow button from this screen.

Press the Down arrow button twice from the “English” screen to go to the “Spanish” screen. Now press the Left arrow button from this screen.

### 5-2.13.2 Selecting the Display Units

From the “Display Configuration” title screen, press the Down arrow button three times. Once the “Select Units” screen appears, press the Left arrow button one time.

If English units are desired, press the Left arrow button and select the desired unit of measure (“US gallons” or “Imperial gallons”). If “Imperial Gallons” is selected, then an “IG” will be displayed to the driver. As an example, the display will show “MPIG”, “IGAL”, etc.

If Metric units are desired, press the Down arrow button from the “Units English” screen. Now, press the Left arrow button from this screen and select the desired units (“kilometers/liter” or “liters/100 kilometers”).

### 5-2.13.3 Adjusting the Brightness of the Display

The contrast may be adjusted by pressing and releasing the Right arrow button or the Left arrow button from the Adjust Contrast screen. The characters may be lightened by pressing and releasing the Left arrow button until the illumination is satisfactory. The background may be darkened by pressing and releasing the Right arrow until the background is satisfactory.

The Down arrow button may be used in order to change the backlight. The backlight may be turned off by pressing and releasing the Left arrow button. The backlight may be turned on by pressing and releasing the Right arrow button.

The backlight may be adjusted by pressing and releasing the Right arrow button or the Left arrow button. Pressing and releasing the Left arrow button will decrease the backlight. Pressing the releasing the Right arrow button will increase the backlight.



**NOTE:** The automatic dim feature will not function if the display has been placed in a manual dim mode. To reactivate the automatic dim feature, turn the power to the display OFF, then back ON.

## 5-2.14 “Driver Entry” Screens for the 3176B, 3176C, C-10, C11, C-12, C13, C15, C-15, C-16, and 3406E Engines Only

### 5-2.14.1 Two Different DRIVER IDs

The Caterpillar 3176B, 3176C, C-10, C11, C-12, C13, C15, C-15, C-16, and 3406E ECM can maintain information for two different DRIVER IDs at the same time. The ECM will separately store “Fleet Trip” information for each of the two drivers. This function is especially suited for slip seat or more than one driver per the vehicle. This function could also be used by the same driver to record vehicle operation over two legs of a trip. A single driver would use two different DRIVER IDs to identify each different leg of the trip. The DRIVER IDs should be chosen prior and entered into the display prior to operating the vehicle.

The Messenger display will indicate the last driver as the active driver in the system. If the Fleet Trip Segment has been reset, the display will indicate “NO ACTIVE DRIVER”. Press any button in order to continue.

The “Fleet Trip” information is unavailable for display on the Messenger display to either driver. This information is only available through use of the “Caterpillar Fleet Information Software” program.

### 5-2.14.2 Entering a New Driver ID

A maximum of two different DRIVER IDs may be used for each “Fleet Trip Segment”. If a third DRIVER ID is desired, the “Fleet Trip Segment” must be reset. After the “Fleet Trip Segment” has been reset, the previous DRIVER IDs are cleared. The two new DRIVER IDs may now be added to the next “Fleet Trip Segment”. Press the Up arrow button or press the Down arrow button in order to scroll through the letters A to Z. Press the Right arrow button and the Left arrow button in order to move between locations of the characters. Press the Up arrow button or the Down arrow button in order to scroll through numbers 0 to 9.

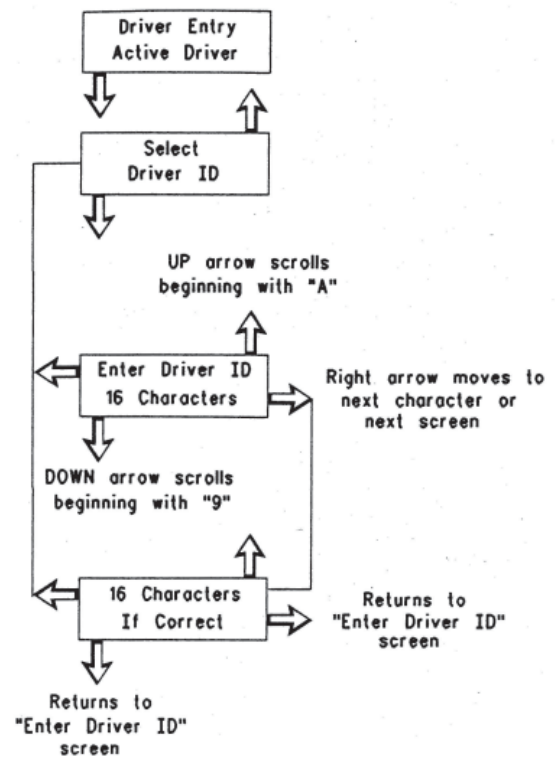

Figure 14 - Enter Identification of the driver.

### 5-2.14.2 “Selecting a Previously Entered DRIVER ID”

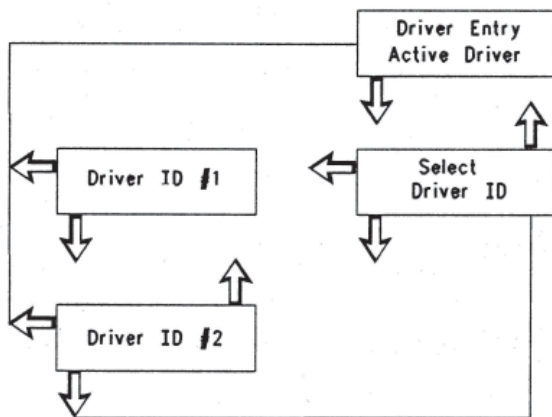

Figure 15 - Select the driver.

Only the DRIVER IDs that have been entered during the current “Fleet Trip Segment” may be viewed. The DRIVER ID may be toggled between drivers per the following instructions. Press the Down arrow button from the “Driver Entry” screen. The “SELECT DRIVER ID” screen will be shown. Press the Left arrow button. One of the two DRIVER IDs that were previously entered will be shown. A “NO DRIVER ID ENTERED!” message will appear if a DRIVER ID has not been entered. Pressing and releasing the Down arrow button will show any other DRIVER ID. Press and release the Left arrow button in order to select a DRIVER ID as the active driver.

Table 16 - "Driver Entry Screens Table"

Screen	Parameter	Description
"Driver Entry" "Active Driver"	"Driver Entry Title Screen"	This screen shows the current DRIVER IDs whenever the text for "ACTIVE DRIVER" is indicated. This is the second screen after the display is first powered up. This is shown automatically. Pressing any button will display the next screen in the power up sequence. Press the Left arrow button in order to move one column to the Left. Press the Down arrow button in order to select the DRIVER ID screen. If the "Fleet Trip" has been reset, the screen will indicate "NO ACTIVE DRIVER" when the "ACTIVE DRIVER" text is indicated.
"Select " "DRIVER ID"	"Select Previously Entered DRIVER ID"	Press the Left arrow button in order to select one of the two DRIVER IDs. The first DRIVER ID will be shown. If no DRIVER IDs have been entered, a message "NO DRIVER IDs ENTERED!" will appear. Press any button to go back to the "DRIVER ENTRY" title screen.
"DRIVER ID" #1	"Select DRIVER ID #1"	This screen shows the first DRIVER ID. The screen will indicate "DRIVER ID 1". Press the Left arrow button in order to enter the ID code as the current driver. The display will begin recording information for this driver. Display returns to "DRIVER ENTRY" title screen.
"DRIVER ID" #2"	"Select DRIVER ID #2"	This screen shows the second DRIVER ID that was entered. Press the Left arrow button in order to enter this ID code as the current driver. The display will begin to record information on the second driver. Display returns to "DRIVER ENTRY" title screen.
"Enter DRIVER ID"	"Enter New DRIVER ID"	Press the Down arrow button or the Up arrow button in order to scroll through numbers 0 to 9. Press the Down arrow button or the Up arrow button in order to scroll through letters A to Z. The Right arrow button and Left arrow button move between locations for the characters. A space may be entered by moving through a space for a character without selecting a character. Press the Down arrow button and release the Down arrow button in order to scroll through the available characters. Press the Up arrow button and release the Up arrow button in order to scroll through the available characters. If two DRIVER IDs have been entered, a "MAX DRIVER IDs ENTERED!" message will appear. Press any button in order to return to the "DRIVER ENTRY" title screen. If no characters have been entered a message will appear. The display will show "A CHARACTER MUST BE ENTERED!" on the screen.
"If DRIVER ID Correct"	"Accept New DRIVER ID"	This screen shows the DRIVER ID that was entered. Press the Left arrow button in order to enter this DRIVER ID and return the display to the "DRIVER ENTRY" title screen. This ID code will be shown as the "Current Driver". All vehicle data will be recorded to this driver. Press the Up, Down, or Right arrow button in order to return the display to the "ENTER NEW DRIVER ID" screen. This may be done in order to clear the DRIVER ID that was just entered.

## 5-2-15 State Crossing Screens

### 5-2.15.1 The 3176B, 3176C, C-10, C11, C-12, C13, C15, C-15, C-16, and 3406E Engines Only

The Messenger display will record information for the "Distance Traveled", "Fuel Used", "PTO Fuel Used", and "Idle Fuel Used" in the United States or in Canada. The state must be entered in order for the display to record the information for the vehicle. The screen will show the last state that was entered into the display. This information is reset with the "Fleet Trip Segment". The state selection should be performed when the vehicle is not moving. All fifty US states and twelve Canadian provinces are provided in this display.

### 5-2.15.2 Accessing State Crossings

“ECM Customer Programmable Parameters” determine the access to this function of the dash display. If information for the state is programmed OFF, the entire “State Crossing” column will not be shown. Press the Right arrow button from the “DRIVER ENTRY” title screen. Press the Left from the “INSTANTANEOUS DATA” title screen. This will cause the display to skip the STATE CROSSING screen.

After programming the parameters in the ECM, the power must be turned OFF and the power turned ON again in order for the display to recognize the change.

### 5-2.15.3 Selecting a State

The STATE CROSSING title screen displays the currently selected state. This is illustrated as the “CURRENT STATE” in Figure 16. Press the Down arrow button in order to show more states. The display will list all adjacent states to the current state first. The display will list all adjacent states in an alphabetical order to the current state. Press the Up and Down arrow buttons in order to scroll through the list.

Continue to scroll through the list of adjacent states in order to select a state that is not adjacent to the current state. The list will start with a full alphabetical list of all available states and provinces.

When the desired state is displayed, press the Left arrow button. The display will again show the selected state. Press the Left arrow button in order to enter the displayed state as the current state. Press any other button in order to select a different state.

State Crossing Screen

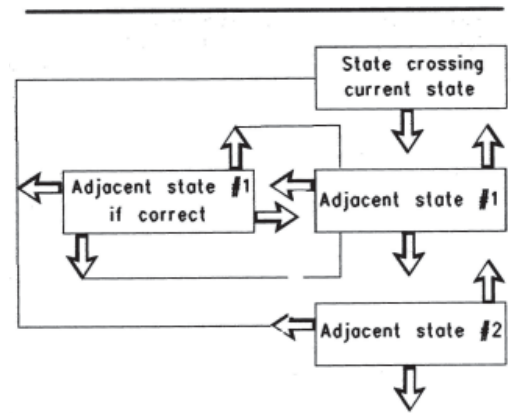

Available states are listed alphabetically  
Figure 16

Table 17 - “State Entry Screens”

Screen	Parameter	Description
“State Crossing” “Current State”	State Crossing Title Screen	<p>This screen shows the “Current State” of operation. If a state has not been entered, the message “No Active State” will appear. The “No Active State” will occur only with a new display until one state is entered.</p> <p>The screen will be automatically shown when the display is first powered up. This screen will be shown after the “Active Driver” screen. Press any button in order to show the next screen in the power up sequence.</p> <p>If the “Fleet Trip” information has been reset, the current state is maintained.</p> <p>Press the Left arrow button in order to move one column to the Left.</p> <p>Press the Right arrow button in order to move one column to the Right.</p> <p>Press the Down arrow button in order to select another state.</p> <p>Fifty entries for “State Crossing” are the maximum number that is allowed until the display is reset. A “STATES ALLOWED EXCEEDED!” message will appear after the entry of fifty.</p> <p>Press any button in order to return to the STATE CROSSING title screen. The display will not allow the addition of any additional “State Crossings” until the “Fleet Trip” has been reset.</p>
“Adjacent State #1”	“Select a different state”	<p>Press the Up arrow button or press the Down arrow button in order to scroll through the list of states.</p> <p>The display will list all adjacent states to the current state first. The display will list all adjacent states in an alphabetical order to the current state. When adjacent states are exhausted, the display begins listing all states in alphabetical order.</p> <p>Press the Left arrow button in order to select the desired state.</p> <p>The Up and Down arrow buttons will scroll forward and backward through the list.</p>
“Adjacent State #1 if Correct”	“Enter selected state”	<p>This screen shows the state that was just selected. If this state is desired, press the Left arrow button and display returns to STATE CROSSING title screen with this state as the “Current State”. If this state is incorrect, press any arrow button in order to return to the list of states.</p>

## 5-2.16 Troubleshooting

The following is a list of possible problems that may occur.

### 1. Unable to Read Characters on the Display

*Probable Cause*

- Portions of the display may not light. Part of a character is missing, etc. The unit must be replaced.

### 2. The Display May Not Have Power

*Probable Cause*

- Make sure that the ON button has been pressed.
- Loose power or loose ground connections to the display.
- The vehicle battery is dead.
- After checking the above items, if condition still exists refer to Step 1 of Diagnostic Test.

### 3. No Data Link Communication

*Probable Cause*

- No connection or an intermittent connection in one of the two Data Link lines to the engine ECM
- Connection to the J1922 Data Link or the J1939 Data Link instead of the J1708 ATA Data Link
- The data link lines must be the twisted pair.
- The engine has no power, intermittent power, or poor ground connections to the engine ECM. After checking the above items, if a condition still exists refer to Step 4 of the Diagnostic Test.

### 4. All Data Except Lifetime Totals Has Been Reset

*Probable Cause*

- The unswitched battery connection to the engine ECM is disconnected. This is possibly due to vehicle service or a battery disconnect switch.
- The data has been intentionally reset with the display. "Caterpillar Fleet Information Software", or the electronic service tool. Determine the reason for the reset and avoid the conditions that caused this event. If a different system problem is suspected, consult a qualified service center.

### 5. The Fleet, Driver Trip Data, and Lifetime Totals Have Been Reset

*Probable Cause*

- The engine ECM was recently replaced. Determine the reason for the reset and avoid the conditions that caused this event. If a different system problem is suspected, consult a qualified service center.

### 6. The Driver is unable to adjust the Fleet Trip or unable to reset the maintenance. The driver is unable to reset the "Fuel Correction".

*Probable Cause*

- The ECM parameters are programmed to prevent the reset of these parameters by the customer. The electronic service tool and authorization from the owner will be necessary to reset the ECM. This will allow access to these functions from the display.
- The power to the display was turned OFF and the power was turned ON in order for the display to recognize the charge.

### 7. The Driver is unable to access the "Fleet Trip State Totals" and "State Crossing" Information.

*Probable Cause*

- The ECM parameters are programmed OFF in order to prevent access to this information. The electronic service tool and authorization from the owner will be necessary to reset the ECM. This will allow access to this information.
- The power must be turned OFF and the power turned ON in order for the display to recognize any changes to the ECM.

### 8. Certain "Instantaneous Data" Parameters Appear to be Unavailable.

- This information is not available on the data link. Verify that the appropriate sensors are installed. For example, if Ambient Air Temperature is not shown by the display, verify that an Ambient Air Sensor is installed on the vehicle.

### 9. The Display Will Not Become Dim on the Circuit for the Panel Dimmer

- The dimmer circuit on the vehicle is not a Pulse Width Modulated (PWM) circuit. Contact the vehicle manufacturer in order to determine if the vehicle has a PWM dimmer circuit.

Table 18

<b>“Parameter”</b>	<b>Available Range or Options</b>	<b>Default</b>
<b>“SELECTED ENGINE RATING”</b>		
“Rating Number”	Dependent on engine power	
“Multitorque Ratio”	Unavailable (Standard Ratings) “MT-A” “MT-B” “MT-C”	Unavailable (Standard Ratings) “MT-A” (Multitorque Ratings)
<b>“ECM IDENTIFICATION PARAMETERS”</b>		
“Vehicle ID”	17 Digits Available characters are dependent on the service tools	all zeroes
<b>“SECURITY ACCESS PARAMETERS”</b>		
“ECM Wireless Communication Enable”	“No” “Yes”	“No”
<b>“SECURITY ACCESS PARAMETERS”</b>		
“Vehicle Speed Calibration”	2485 to 93226 PPKM (4000 to 150000 PPM)	Not Programmed
“Vehicle Speed Cal (J1939 - Trans)”	0 to 430000 revolutions per km (0 to 65000 revolutions per mile)	Not Programmed
“Vehicle Speed Cal (J1939 - ABS)”	0 to 6.550	Not Programmed
“Vehicle Speed Limit”	48 to 204 km/h (30 to 127 mph)	204 km/h (127 mph)
“VSL Protection”	1000 to TEL rpm	TEL rpm
“Tachometer Calibration”	12.0 to 500.0 pulses per revolution	113.0 pulses per revolution
“Soft Vehicle Speed Limit”	“No” “Yes”	“No”
“Two Speed Axle - Low Speed Range Axle Ratio”	1.00 to 19.99	1.00
“Nominal Axle Ratio - High Speed Range Axle Ratio”	1.0 to 9.99	1.00
<b>“CRUISE CONTROL PARAMETERS”</b>		
“Low Cruise Control Speed Set Limit”	24 to 204 km/h (15 to 127 mph)	204 km/h (127 mph)
“High Cruise Control Speed Set Limit”	48 to 204 km/h (30 to 127 mph)	204 km/h (127 mph)
“Engine Retarder Mode”	“Coast” “Latch” “Manual”	“Manual”
“Engine Retarder Minimum VSL Type”	“Hard Limit” “Soft Limit”	“Hard Limit”
“Engine Retarder Minimum Vehicle Speed”	0 to 204 km/h (0 to 127 mph)	0 km/h (0 mph)
“Auto Retarder in Cruise (0 - Off)”	0 to 16 km/h (0 to 10 mph)	0 km/h (0 mph)
“Auto Retarder in Cruise Increment”	0 to 8 km/h (0 to 5 mph)	3 km/h (2 mph)
“Cruise/ Idle/PTO Switch Configuration”	“Set/Accel-Res/Decel” “Set/Decel-Res/Accel”	“Set/Accel-Res/Decel”
“Soft Cruise Control”	“No” “Yes”	“Yes”
“Adaptive Cruise Control Enable”	“Disabled” “Enabled”	“Disabled”



Table 18 - Continued

<b>“Parameter”</b>	<b>Available Range or Options</b>	<b>Default</b>
<b>“IDLE PARAMETERS”</b>		
“Idle Vehicle Speed Limit”	2 to 24 km/h (1 to 15 mph)	2 km/h (1 mph)
“Idle RPM Limit”	Low Idle to 2120 rpm	2120 rpm
“Idle/PTO RPM Ramp Rate”	5 to 1000 rpm/sec	50 rpm/sec
“Idle/PTO Bump RPM”	5 to 500 rpm	20 rpm
<b>“DEDICATED PTO PARAMETERS”</b>		
“PTO Configuration”	“Cab Switches” “Off” “Remote Switches” “Remote Throttle”	“Off”
“PTO Top Engine Limit”	Low Idle to 2120 rpm	2120 rpm
“PTO Engine RPM Set Speed (0 - Off)”	Low Idle to PTO TEL rpm	0
“PTO Engine RPM Set Speed A”	Low Idle to PTO TEL rpm	0
“PTO Engine RPM Set Speed B”	Low Idle to PTO TEL rpm	0
“PTO to Set Speed”	“No” “Yes”	“No”
“Maximum PTO Enable Speed”	Low Idle to PTO TEL rpm	PTO TEL rpm
“PTO Cab Controls RPM Limit”	“Low Idle” “TEL” “PTO TEL”	“TEL”
“PTO Kickout Vehicle Speed Limit”	2 to 204 km/h (1 to 127 mph)	2 km/h (1 mph)
“Max PTO Vehicle Speed”	24 to 204 km/h (15 to 127 mph)	204 km/h (127 mph)
“Torque Limit”	270 N•m (200 lb ft) to Rated Torque	3400 N•m (2500 lb ft)
“PTO Shutdown Time (0 - Off)”	3 to 1440 minutes	0
“PTO Shutdown Timer Maximum RPM”	600 to PTO TEL rpm	PTO TEL rpm
“PTO Activates Cooling Fan”	“Continuous” “Normal”	“Normal”
<b>“ENGINE/GEAR PARAMETERS”</b>		
“Lower Gears Engine RPM Limit”	1100 to TEL rpm	TEL rpm
“Lower Gears Turn Off Speed”	5 to 48 km/h (3 to 30 mph)	5 km/h (3 mph)
“Intermediate Gears Engine RPM Limit”	1100 to TEL rpm	TEL rpm
“Intermediate Gears Turn Off Speed”	8 to 80 km/h (5 to 50 mph)	8 km/h (5 mph)
“Gear Down Protection RPM Limit”	1300 to TEL rpm	TEL rpm
“Gear Down Protection Turn On Speed”	48 to 204 km/h (30 to 127 mph)	204 km/h (127 mph)
“Low Idle Engine RPM”	600 to 750 rpm	600 rpm
“Transmission Style”	“Automatic Option 1” “Automatic Option 2” “Automatic Option 3” “Automatic Option 4” “Eaton Top 2” “Manual Option 1”	“Manual Option 1”

Table 18 - Continued

<b>“Parameter”</b>	<b>Available Range or Options</b>	<b>Default</b>
<b>“ENGINE/GEAR PARAMETERS” - Continued</b>		
“Eaton Top 2 Override with Cruise Switch”	“No” “Yes”	“No”
“Top Gear Ratio”	0.000 to 3.750	0.000
“Top Gear Minus One Ratio”	0.000 to 3.750	0.000
“Top Gear Minus Two Ratio”	0.000 to 3.750	0.000
“Governor Type”	“Full Range” “Min/Max” “Min/Max with Speed Control”	“Full Range”
<b>“TIMER PARAMETERS”</b>		
“Idle Shutdown Time (0 - Off)”	3 to 1440 minutes	0 minutes
“Idle Shutdown Timer Maximum RPM”	Low Idle to 2120 rpm	2120 rpm
“Allow Idle Shutdown Override”	“J1587 Outside Temp Based” “No” “Outside Temperature Based” “Yes”	“Yes”
“Minimum Idle Shutdown Outside Temp”	-40° to 49° C (-40° to 120° F)	49° C (120° F)
“Maximum Idle Shutdown Outside Temp”	-40° to 49° C (-40° to 120° F)	49° C (120° F)
“A/C Switch Fan On - Time (0 - Off)”	1 to 600 seconds	0 seconds
“Fan with Engine Retarder in High Mode”	“No” “Yes”	“No”
“Engine Retarder Only”	0.0 to 3.0 seconds	0.0 seconds
<b>“SMART IDLE PARAMETERS”</b>		
“Battery Monitor and Engine Control Voltages”	0 to 25.5 volts	0.0 volts
<b>“ENGINE MONITORING PARAMETERS”</b>		
“Engine Monitoring Mode”	“Derate” “Shutdown” “Warning”	“Warning”
“Engine Monitoring Lamps”	“Option 1” “Warning Lamp”	“Warning Lamp”
“Coolant Level Sensor”	“2-wire Float Sensor” “4-pin” “No”	“No”
“Engine Coolant Temperature Derate Enable Status”	“Disabled” “Enabled”	“Disabled”

Table 18 - Continued

<b>“Parameter”</b>	<b>Available Range or Options</b>	<b>Default</b>
<b>“MAINTENANCE PARAMETERS”</b>		
“Maintenance Indicator Mode”	“Automatic Distance” “Automatic Hours” “Manual Distance” “Manual Hours” “Off”	“Off”
“PM 1 Interval (Manual Maintenance Indicator Mode)”	8050 to 56325 km (5000 to 35000 miles) 100 to 750 hours	2140 km (15000 miles) 250 hours
“Engine Oil Capacity”	19 to 57 L (20 to 60 qt)	C11, C13, 34 L (36 qt)
<b>“TRIP PARAMETERS”</b>		
“Fuel Correction Factor”	-63 to 63.5%	0%
“Dash-Change Fuel Correction Factor”	“No” “Yes”	“No”
“Dash-PM 1 Reset”	“No” “Yes”	“No”
“Dash-Fleet Trip Reset”	“No” “Yes”	“No”
“Dash-State Selection”	“No” “Yes”	“Yes”
“Theft Deterrent System Control”	“Auto-Enable” “No” “Yes”	“No”
“Theft Deterrent Password”	Four Characters	0000
“Quick Stop Rate”	5 to 24 km/h per sec (3 to 15 mph per sec)	0 km/h per sec (0 mph per sec)
“Vehicle Overspeed Threshold”	48 to 204 km/h (30 to 127 mph)	204 km/h (127 mph)
<b>“VEHICLE ACTIVITY REPORT PARAMETERS”</b>		
“Minimum Idle Time (0 - Off)”	0 to 1440 minutes	0 minutes
<b>“DRIVER REWARD”</b>		
“Driver Reward Enable”	“Disabled” “Enabled”	“Enabled”
<b>“INPUT SELECTIONS”</b>		
“Fan Override Switch”	“J1/P1:46” “J1/P1:47” “J1/P1:6” “J1/P1:7” “J1939 - Body Controller” “J1939 - Cab Controller” “J1939 - Instrument Cluster” “None”	“None”
“Transmission Neutral Switch”	“None” “J1939” “J1/P1:62”	“None”
“Ignore Brake/Clutch Switch”	“J1/P1:7” “None”	“None”

Table 18 - Continued

"Parameter"	Available Range or Options	Default
<b>"INPUT SELECTIONS" - Continued</b>		
"Torque Limit Switch"	"J1/P1:7" "None"	"None"
"Diagnostic Enable"	"J1/P1:7" "J1939 - Body Controller" "J1939 - Cab Controller" "J1939 - Instrument Cluster" "None"	"None"
"PTO On/Off Switch"	"J1/P1:56" "J1939 - Cab Controller" "J1939 - Body Controller" "J1939 - Instrument Cluster" "None"	"J1/P1:56"
"Remote PTO Set Switch"	"J1/P1:58" "J1939 - Body Controller" "J1939 - Cab Controller" "J1939 - Instrument Cluster" "None"	"J1/P1:58"
"Remove PTO Resume Switch"	"J1/P1:60" "J1939 - Body Controller" "J1939 - Cab Controller" "J1939 - Instrument Cluster" "None"	"J1/P1:60"
"PTO Engine RPM Set Speed Input A"	"J1/P1:46" "J1/P1:58" "J1/P1:6" "J1/P1:60" "J1939 - Body Controller" "J1939 - Cab Controller" "J1939 - Instrument Cluster" "None"	"None"
"PTO Engine RPM Set Speed Input B"	"J1/P1:46" "J1/P1:58" "J1/P1:6" "J1/P1:60" "None"	"None"
"Starting Aid On/Off Switch"	"J1/P1:46" "J1/P1:47" "J1/P1:6" "J1/P1:7" "None"	"None"
"Two-Speed Axle Switch"	"J1/P1:6" "J1939 - Body Controller" "J1939 - Cab Controller" "J1939 - Instrument Cluster" "None"	"None"
"Cruise Control On/Off Switch"	"J1/P1:59" "J1939 - Body Controller" "J1939 - Cab Controller" "J1939 - Instrument Cluster"	"J1/P1:59"

Table 18 - Continued

"Parameter"	Available Range or Options	Default
<b>"INPUT SELECTIONS" - Continued</b>		
"Cruise Control Set/Resume/Accel/Decel Switch"	"J1/P1:35 & 44" "J1939 - Cab Controller" "J1939 - Body Controller" "J1939 - Instrument Cluster"	"J1/P1:35 & 44"
"Cruise Control Pause Switch"	"J1939 - Body Controller" "J1939 - Cab Controller" "J1939 - Instrument Cluster" "None"	"None"
"Clutch Pedal Position Switch"	"J1/P1:22" "J1939 - Body Controller" "J1939 - Cab Controller" "J1939 - Instrument Cluster"	"J1/P1:22"
"Retarder Off/Low/Medium/High Switch"	"J1/P1:23 & 40" "J1939 - Body Controller" "J1939 - Cab Controller" "J1939 - Instrument Cluster"	"J1/P1:23 & 40"
"Service Brake Pedal Position Switch #1"	"J1/P1:45" "J1939 - Body Controller" "J1939 - Cab Controller" "J1939 - Instrument Cluster"	"J1/P1:45"
"Accelerator Pedal Position"	"J1/P1:66"	"J1/P1:66"
"Vehicle Speed Input"	"J1/P1:32 & 33" "J1939 - ABS" "J1939 - Trans"	"J1/P1:32 & 33"
<b>"OUTPUT SELECTIONS"</b>		
"Engine Running Output"	"J1/P1:10" "J1/P1:12" "J1/P1:13" "None"	"None"
"Engine Shutdown Output"	"J1/P1:10" "J1/P1:12" "J1/P1:13" "None"	"None"
"Auxiliary Brake"	"J1/P1:12" "None"	"None"
"Starting Aid Output"	"J1/P1:10" "J1/P1:12" "J1/P1:13" "None"	"None"
"Air Inlet Shutoff Relay Control"	"J2/P2:13" "None"	"None"

Table 18 - Continued

"Parameter"	Available Range or Options	Default
<b>"OUTPUT SELECTIONS" - Continued</b>		
"Fan Control Type"	"None" "On/Off PWM" "On/Off DC" "Three-Speed Fan PWM" "Three-Speed Fan DC" "Variable Speed Fan Option S"	"None"
"PTO Active Output"	"J1/P1:19" "None"	"None"
<b>"CUSTOMER PASSWORDS"</b>		
"Customer Password #1"	8 Digits Available characters are dependent on the service tools.	Not Programmed
"Customer Password #2"		
<b>"DATA LINK PARAMETERS"</b>		
"Power Train Data Link"	"J1939" "None"	"J1939"

## Customer Specified Parameters Worksheet

Table 19

<b>“SELECTED ENGINE RATING”</b>	
“Rating Number”	
“Rating Type”	
“Multitorque Ratio”	
“Advertised Power”	
“Governed Speed”	
“Rated Peak Torque”	
“Top Engine Speed Range”	
“Test Spec”	

Table 20

<b>“ECM IDENTIFICATION PARAMETERS”</b>	
“Vehicle ID”	
“Engine Serial Number”	
“ECM Serial Number”	
“Personality Module Part Number”	
Personality Module Release Date”	

Table 21

<b>“SECURITY ACCESS PARAMETERS”</b>	
“Total Tattletale”	
“Last Tool to change Customer Parameters”	
“Last Tool to change System Parameters”	
“ECM Wireless Communication Enable”	

Table 22

<b>“SECURITY ACCESS PARAMETERS”</b>	
“Vehicle Speed Calibration”	
“Vehicle Speed Cal (J1939) - Trans”	
“Vehicle Speed Cal (J1939) - ABS”	
“Vehicle Speed Limit” (VSL)	
“VSL Protection”	
“Tachometer Calibration”	
“Soft Vehicle Speed Limit”	
“Two Speed Axle - Low Speed Range Axle Ratio”	
“Nominal Axle Ratio - High Speed Range Axle Ratio”	

Table 23

<b>“CRUISE CONTROL PARAMETERS”</b>	
“Low Cruise Control Speed Set Limit”	
“High Cruise Control Speed Set Limit”	
“Engine Retarder Mode”	
“Engine Retarder Minimum VSL Type”	
“Engine Retarder Minimum Vehicle Speed”	
“Auto Retarder in Cruise (0 - Off)”	
“Auto Retarder in Cruise Increment”	
“Cruise/Idle/PTO Switch Configuration”	
“Soft Cruise Control”	
“Adaptive Cruise Control Enable”	

Table 24

<b>“IDLE PARAMETERS”</b>	
“Idle Vehicle Speed Limit”	
“Idle RPM Limit”	
“Idle/PTO RPM Ramp Rate”	
“Idle/PTO Bump RPM”	

Table 25

<b>“DEDICATED PTO PARAMETERS”</b>	
“PTO Configuration”	
“PTO Top Engine Limit”	
“PTO Engine RPM Set Speed (0 - Off)”	
“PTO Engine RPM Set Speed”	
“PTO Engine RPM Set Speed A”	
“PTO Engine RPM Set Speed B”	
“PTO to Set Speed”	
“Maximum PTO Enable Speed”	
“PTO Cab Controls RPM Limit”	
“PTO Kickout Vehicle Speed Limit”	
“Max PTO Vehicle Speed”	
“Torque Limit”	
“PTO Shutdown Time (0 - Off)”	
“PTO Shutdown Timer Maximum RPM”	
“PTO Activates Cooling Fan”	

Table 26

<b>“ENGINE/GEAR PARAMETERS”</b>	
“Lower Gears Engine RPM Limit”	
“Lower Gears Turn Off Speed”	
“Intermediate Gears Engine RPM Limit”	
“Intermediate Gears Turn Off Speed”	
“Gear Down Protection RPM Limit”	
“Gear Down Protection Turn On Speed”	
“Low Idle Engine RPM”	
“Transmission Style”	
Eaton Top 2 Override with Cruise Switch	
“Top Gear Ratio”	
“Top Gear Minus One Ratio”	
“Top Gear Minus Two Ratio”	
“Governor Type”	

Table 27

<b>“TIMER PARAMETERS”</b>	
“Idle Shutdown Time (0 = Off)”	
“Idle Shutdown Timer Maximum RPM”	
“Allow Idle Shutdown Override”	
“Minimum Idle Shutdown Outside Temp”	
“Maximum Idle Shutdown Outside Temp”	
“A/C Switch Fan On-Time (0 = Off)”	
“Fan with Engine Retarder in High Mode”	
“Engine Retarder Delay”	

Table 28

<b>“SMART IDLE PARAMETERS”</b>	
“Battery Monitor and Engine Control Voltage”	

Table 29

<b>“ENGINE MONITORING PARAMETERS”</b>	
“Engine Monitoring Mode”	
“Engine Monitoring Lamps”	
“Coolant Level Sensor”	
“Engine Coolant Temperature Derate Enable Status”	

Table 30

<b>“MAINTENANCE PARAMETERS”</b>	
“Maintenance Indicator Mode”	
“PM 1 Interval”	
“Engine Oil Capacity”	

Table 31

<b>“TRIP PARAMETERS”</b>	
“Fuel Correction Factor”	
“Dash - Change Fuel Correction Factor”	
“Dash - PM 1 Reset”	
“Dash - Fleet Trip Reset”	
“Dash - State Selection”	
“Theft Deterrent System Control”	
“Theft Deterrent Password”	
“Quick Stop Rate”	
“Vehicle Overspeed Threshold”	

Table 32

<b>“VEHICLE ACTIVITY REPORT PARAMETERS”</b>	
“Minimum Idle Time (0 = Off)”	

Table 33

<b>“DRIVER REWARD”</b>	
“Driver Reward Enable”	



Table 34

<b>"INPUT SELECTIONS"</b>	
"Fan Override Switch"	
"Transmission Neutral Switch"	
"Ignore Brake/Clutch Switch"	
"Torque Limit Switch"	
"Diagnostic Enable"	
"PTO On/Off Switch"	
"Remote PTO Set Switch"	
"Remote PTO Resume Switch"	
"PTO Engine RPM Set Speed Input A"	
"PTO Engine RPM Set Speed Input B"	
"Starting Aid On/Off Switch"	
"Two Speed Axle Switch"	
"Cruise Control On/Off Switch"	
"Cruise Control Set/Resume/Accel/Decel Switch"	
"Cruise Control Pause Switch"	
"Clutch Pedal Position Switch"	
"Retarder Off/Low/Medium/High Switch"	
"Service Brake Pedal Position Switch #1"	
"Accelerator Pedal Position"	
"Vehicle Speed Input"	

Table 35

<b>"OUTPUT SELECTIONS"</b>	
"Engine Running Output"	
"Engine Shutdown Output"	
"Auxiliary Brake"	
"Starting Aid Output"	
"Air Inlet Shutoff Relay Control"	
"Fan Control Type"	
"PTO Active Output"	

Table 36

<b>"CUSTOMER PASSWORDS"</b>	
"Customer Password #1"	
"Customer Password #2"	

Table 37

<b>"DATA LINK PARAMETERS"</b>	
"Powertrain Data Link"	

**Lifetime Totals Worksheet**

Table 38

<b>"LIFETIME TOTALS WORKSHEET"</b>	
Total Time	
Total PTO Time	
Total Idle Time	
Total Distance	
Total Fuel	
Total PTO Fuel	
Total Idle Fuel	
Total Maximum Fuel	
Average Load Factor	

## 5-2.17 Diagnostic Test

Table 39

"Test"	"Result"	"Action"
<p><b>"Check Electrical Connectors and Wiring"</b> Follow the wiring harness for the display and locate the connector from the display to the vehicle. Inspect the wiring harness for evidence of wear through the harness bundle. Check the harness connector. Ensure that the connector is properly locked. Pull on each of the wires in the connector. Refer to Troubleshooting "<a href="#">Electrical Connectors-Inspect</a>" for additional information.</p>	"OK"	"Proceed to next step."
	"Not OK"	Repair the problem. If conditions are not resolved then proceed to next step.
<p><b>"Check Battery Voltage at Vehicle Connector"</b> Turn the ignition key OFF and disconnect the dash display connector. Turn the ignition key ON and measure the DC voltage. Use a voltmeter in order to measure the DC voltage from pin 3 (red wire from display) to pin 4 (black wire from display) of the vehicle connector. The battery voltage should be 11 to 13.5 Volts DC. Pull on each of the wires in the connector. Inspect batteries, wiring, and connectors.</p>	"OK"	"Proceed to next step."
	"Not OK"	Repair the problem. If conditions are not resolved then proceed to next step.
<p><b>"Connect Display to 12 Volt Power Source"</b> Disconnect display from vehicle wiring and connect to another 12 Volt DC power source. Connect pin 3 (red wire from display) to the positive terminal (+ Battery) of the power source. Connect pin 4 (black wire from display) to the negative terminal "(-Battery)" of the power source. The display should illuminate. The display will not communicate until the display is connected to the data link. Check wiring, connectors, or the vehicle battery for damage.</p>	"OK"	Repair the components or replace the components, as required, proceed to next step.
	"Not OK"	Display is fault.
<p><b>"Connect Display to Another Data Link Connector"</b> Disconnect display from the vehicle wiring harness. Connect the display to the other data link connector. The display will activate when the display is connected to the proper data link. The display will communicate when the display is connected to the proper data link. Connect the electronic service tool to the cab Data Link connector. Turn the ignition key ON in order to verify that the data link is functional. . .Verify that the connections to the display are not connected to the J1922 Data Link or the J1939 Data Link. If a cab data link connector is not available, connect the electronic service tool directly to the engine ECM. Verify that the electronic service tool functions. Configure a harness adapter to go from the Data Link connector for the display to the appropriate data link connector. Refer to the "Harness Adapter Diagrams" in order to view the pin-out for some common Data Link connectors. Check the display's wiring or connectors for damage.</p>	"OK"	Repair the components or replace the components, as required.
	"Not OK"	Proceed to the next step.

## 5-2.18 General Information

### 5-2.18.1 Components for the Messenger Display

Table 40

Callout	Description	Quantity
1	Messenger Display	1
2	Buttons	1
3	Mounting Bracket	2
4	#6 Pan Head Screw	4
5	Gimbal Mounting Bracket	1

### Connector A

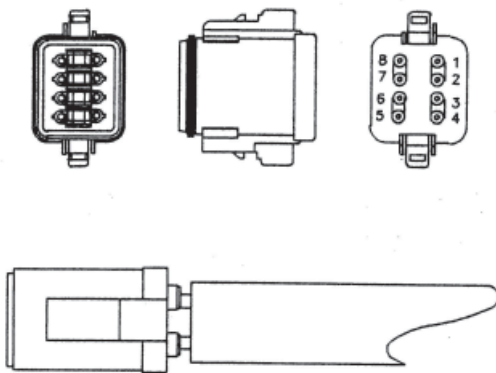

Figure 18

Table 41

"CONNECTOR A WIRE TABLE"		
"Signal ID"	Pin #	Color
CDL/ATA+	1	Yellow
CDL/ATA-	2	Lt. Blue
+Battery	3	Red
Battery Ground	4	Black
Dimmer	5	Purple
Plugged	6	*

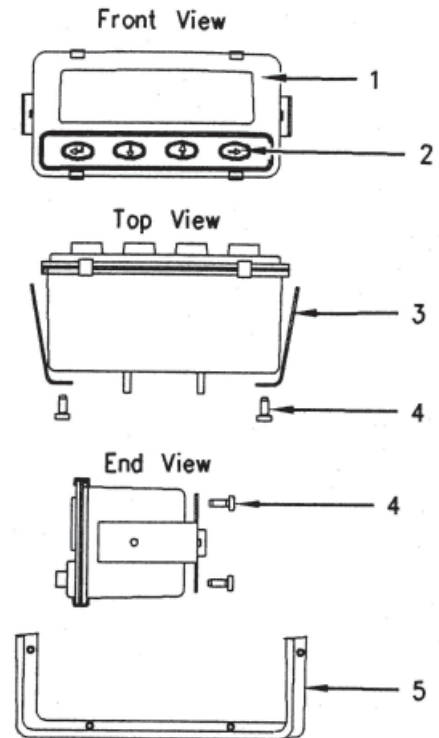

Figure 17

**This Page Was  
Intentionally  
Left Blank**

## 5-3 Engine Maintenance

### 5-3.1 Refill Capacities and Recommendations

#### 5-3.1.1 Engine Oil

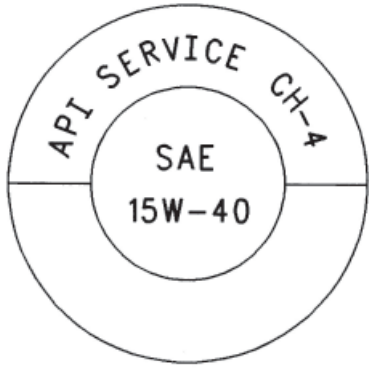

Typical API Symbol

#### API Oils

The Engine Oil Licensing and Certification System by the American Petroleum Institute (API) is recognized by Caterpillar. For detailed information about this system, see the latest edition of the "API publication No. 1509". Engine oils that bear the API symbol are authorized by API.

Diesel engine oils, CC, CD, CD-2, and CE have not been API authorized classifications since January 1, 1996. The API Classification Table that follows summarizes the status of the classifications.

API Classifications	
Current	Obsolete
C1-4 <sup>(1)</sup> , CH-4 <sup>(1)</sup> , CG-4 <sup>(2)</sup> , CF-4 <sup>(3)</sup>	CE
CF <sup>(4)</sup>	CC, CD
CF-2 <sup>(5)</sup>	CD-2 <sup>(5)</sup>

- (1) API-CH-4 and CI-4 oils are acceptable if the requirements of Caterpillar's ECF-1 (Engine Crankcase Fluid specifications-1) are met. CH-4 and CI-4 oils that have not met the requirements of Caterpillar's ECF-1 Specification may cause reduced engine life.
- (2) API CG-4 oils are acceptable for all Caterpillar diesel engines. When the API CG-4 oils are used, the oil drain interval should not exceed 75 Percent of the standard oil drain interval for your engine.
- (3) API CF-4 oils are no longer recommended for Caterpillar on-highway diesel engines.
- (4) API CF oils are not recommended for Caterpillar on-highway diesel engines.
- (5) API CF-2 and CD-2 oils are classifications for two-cycle diesel engines. Caterpillar does not sell engines that utilize the CD-2 and the API CF-2 oils.

#### 5-3.1.2 Caterpillar Diesel Engine Oil (DEO)

Caterpillar Oils have been developed and tested in order to provide the full performance and service life that has been designed and built into Caterpillar Engines. Caterpillar Oils are currently used to fill diesel engines at the factory. These oils are offered by Caterpillar dealers for continued use when the engine oil is changed. Consult your Caterpillar dealer for more information on these oils.

Due to significant variations in the quality and in the performance of commercially available oils, Caterpillar makes the following recommendations:

- Caterpillar Diesel Engine Oil (DEO) (10W-30)
- Caterpillar Diesel Engine Oil (DEO) (15W-40)

### 5-3.1.3 Lubricant Viscosity Recommendations

The proper SAE viscosity grade of oil is determined by the minimum ambient temperature during cold engine start-up, and the maximum ambient temperature during engine operation.

Refer the following table (minimum temperature) in order to determine the required oil viscosity for starting a cold engine.

Refer to this table in order to select the oil viscosity for engine operation at the highest ambient temperature that is anticipated.



**NOTE:** Generally, use the highest oil viscosity that is available to meet the requirement for the temperature at start-up.

If ambient temperature conditions at engine start-up require the use of multigrade SAE 0W oil, SAE 0W-40 viscosity grade is preferred over SAE 0W-20 or SAE 0W-30.



**NOTE:** SAE 10W-30 is the preferred viscosity grade for the following diesel engines when the ambient temperature is above  $-18^{\circ}\text{C}$  ( $0^{\circ}\text{F}$ ) and below  $40^{\circ}\text{C}$  ( $104^{\circ}\text{F}$ ).

**Engine Oil Viscosities for Ambient Temperatures <sup>(1)</sup>**

Viscosity Grade	Ambient Temperature	
	Minimum	Maximum
SAE 0W-20	$-40^{\circ}\text{C}$ ( $-40^{\circ}\text{F}$ )	$10^{\circ}\text{C}$ ( $50^{\circ}\text{F}$ )
SAE 0W-30	$-40^{\circ}\text{C}$ ( $-40^{\circ}\text{F}$ )	$30^{\circ}\text{C}$ ( $86^{\circ}\text{F}$ )
SAE 0W-40	$-40^{\circ}\text{C}$ ( $-40^{\circ}\text{F}$ )	$40^{\circ}\text{C}$ ( $104^{\circ}\text{F}$ )
SAE 5W-30	$-30^{\circ}\text{C}$ ( $-22^{\circ}\text{F}$ )	$30^{\circ}\text{C}$ ( $86^{\circ}\text{F}$ )
SAE 5W-40	$-30^{\circ}\text{C}$ ( $-22^{\circ}\text{F}$ )	$50^{\circ}\text{C}$ ( $122^{\circ}\text{F}$ )
SAE 10W-30	$-18^{\circ}\text{C}$ ( $0^{\circ}\text{F}$ )	$40^{\circ}\text{C}$ ( $104^{\circ}\text{F}$ )
SAE 10W-40	$-18^{\circ}\text{C}$ ( $0^{\circ}\text{F}$ )	$50^{\circ}\text{C}$ ( $122^{\circ}\text{F}$ )
SAE 15W-40	$-9.5^{\circ}\text{C}$ ( $15^{\circ}\text{F}$ )	$50^{\circ}\text{C}$ ( $122^{\circ}\text{F}$ )



**NOTE:** Supplemental heat is recommended below the minimum recommended ambient temperature.

### 5-3.1.4 S • O • S Oil Analysis

Caterpillar has developed a tool for maintenance management that evaluates oil degradation and the tool also detects the early signs of wear in internal components. The Caterpillar tool for oil analysis is called S • O • S Analysis and the tool is part of the S • O • S Services program. S • O • S Oil Analysis divides oil analysis into three categories:

- Wear Analysis
- Oil Condition
- Additional Tests

The wear analysis monitors metal particles, some oil additives, and some contaminants.

Oil condition uses infrared (IR) analysis to evaluate the chemistry of the oil. Infrared analysis is also used to detect certain types of contamination.

Additional tests are used to measure contamination levels from water, fuel, or coolant. Oil viscosity and corrosion protection can be evaluated, as needed.

### 5-3.1.5 Refill Capacities (Engine Oil)

The refill capacities for the engine crankcase reflect the approximate capacity of the crankcase or sump plus standard oil filters. Auxiliary oil filter systems will require additional oil.

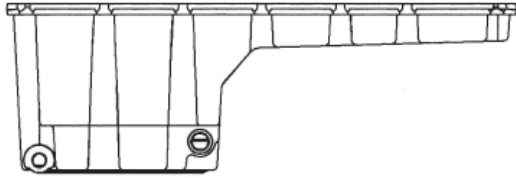

C11 and C13 - 210-1745 Pan (Deep-Standard) This pan has an overall height of 335 mm (13.2 inch).

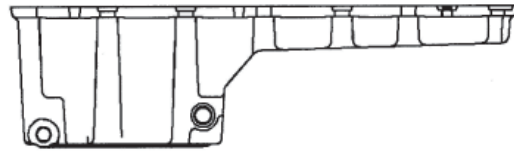

C11 and C13 - 240-3277 Pan (Shallow-Optional) This pan has an overall height of 278 mm (10.9 inch).

#### Approximate Refill Capacities of the Engine Lubrication System

Compartment or System	C13
Standard-Deep Oil Sump <sup>(1)</sup>	40L (42 qt)
Shallow Oil Sump <sup>(1)</sup>	34L (36 qt)
Capacity of the Auxiliary Oil Filter System <sup>(2)</sup>	
Total Capacity of the Lubrication System <sup>(3)</sup>	

(1) Approximate sump capacity of the crankcase includes standard oil filters that are factory installed. Engines with auxiliary oil filters will require additional oil. Optional bypass oil filters that are supplied by Caterpillar require an additional 2.5 L (2.6 qt) of oil. If the engine is equipped with another type of auxiliary oil filter, refer to the OEM specifications for that capacity of the auxiliary oil filter.

(2) Fill in the capacity of the auxiliary oil filter system (if equipped) in the space that is provided.

(3) Fill in the total capacity of the lubrication system. Add the auxiliary oil filter system to the correct capacity of the oil sump in order to find the total capacity of the lubrication system.

### 5-3.1.6 Lubricating Grease

Caterpillar provides a range of moderate greases to extremely high performance greases in order to service the entire line of Caterpillar products that operate throughout the wide variety of climates. From this variety of Caterpillar grease products, you will find at least one of the Caterpillar greases that will meet or exceed the performance requirements for any machine or equipment application.

Before selecting a grease product for any application, the performance requirements must be determined. Consult the grease recommendations that are made by the OEM for the equipment when the equipment is operated in the expected conditions. Then, consult with your Caterpillar dealer for a list of greases and the following related characteristics.

- Performance specifications
- Available sizes of containers
- Part numbers

Always choose a grease that meets or exceeds the recommendations that are specified by the equipment manufacturer for the application.

If it is necessary to choose a single grease to use for all of the equipment at one site, always choose a grease that meets or exceeds the requirements of the most demanding application. Remember, products that barely meet the minimum performance requirements can be expected to barely protect minimum parts life. It is false economy to use grease that was purchased based on the lowest cost per pound. Instead, use the grease that yields the lowest total operating cost based on an analysis that includes the costs of parts, labor, and downtime, as well as the cost of the amount of grease that is actually used.



**NOTES:** Because some greases are not chemically compatible, it is generally recommended to purge all of the old grease from the joint when switching from one type of grease to another, and/or from one supplier to another. Consult your supplier in order to determine if the greases are compatible.  
If in doubt, Purge!

All Caterpillar brand name greases are compatible with each other.

### 5-3.1.7 Fuel

#### Distillate Diesel Fuel

Caterpillar recommends that all distillate diesel fuel, including ULSD fuel (ie fuel ≤ 15 ppm sulfur using ASTM D 2622 or DIN 51400) meet the requirements of the Caterpillar Specifications for Distillate Diesel Fuel.

In North America, diesel fuel that is identified as No. 1-D or No. 2-D in “ASTM D975” generally meet the specifications. Caterpillar recommends diesel fuels that are distilled from crude oil. Diesel fuels from other sources could exhibit detrimental properties that are not defined or controlled by this specification.

 **NOTE:** Caterpillar recommends that fuel be filtered through a fuel filter with a rating of less than five (5) microns absolute at the point where the fuel is dispensed into the vehicle.

 **NOTICE:** Operating with fuels that do not meet Caterpillar’s recommendations can cause the following effects: starting difficulty, poor combustion, deposits in the fuel injectors, reduced service life of the fuel system, deposits in the combustion chamber, and reduced service life of the engine.

### 5-3.2 Coolant

 **NOTICE:** Do not use a commercial coolant/antifreeze that only meets the ASTM D3306 specification. This type of coolant/antifreeze is made for light duty automotive applications.

The following two coolants are used in Caterpillar diesel engines:

**Preferred** - Caterpillar Extended Life Coolant (ELC) or a commercial extended life coolant that meets the Caterpillar EC-1 specification.

**Acceptable** - A Caterpillar Diesel Engine Antifreeze/Coolant (DEAC) or a commercial heavy-duty coolant/antifreeze that meets “ASTM D4985”, or “ASTM D6210” specifications.

 **NOTE:** Caterpillar DEAC does not require a treatment with a SCA at the initial fill. A commercial heavy-duty coolant/antifreeze that meets “ASTM D4985” or “ASTM D6210” specifications MAY require a treatment with an SCA at the initial fill. These coolants WILL require a treatment with an SCA on a maintenance basis.

Service Life Before Flushing and Before Refilling	
Coolant	Service Life <sup>(1)</sup> <sup>(2)</sup> <sup>(3)</sup>
Cat® ELC	965,606 kilometers (600,000 miles) or 12000 hours or 6 years
Commercial coolant that meets the Caterpillar EC-1 specification	482,803 kilometers (300,000 miles) or 6000 hours or 6 years
Cat® DEAC	321,869 kilometers (200,000 miles) or 3000 hours or 3 years
Commercial Heavy-Duty Coolant/Antifreeze that meets “ASTM D4985” or “ASTM D6210”	241,402 kilometers (150,000 miles) or 3000 hours or 1 year

- 1) Whichever comes first
- 2) Refer to the specific engine OMM, “Maintenance Interval Schedule” for the interval for the Cooling System Water Temperature Regulator.
- 3) Cat truck engines with excessive idle time must reduce coolant drain intervals to one-half of the stated kilometers/miles recommendations, or base the coolant service life on the xtated hours. Engine hours of operation are reported in the ECM (Electronic Control Module). Two examples where engines may experience excessive idle time are engines that are normally operated in city pickup and delivery applications, and over the road truck applications where the engines are kept running in order to provide heat and/or air conditioning while the driver sleeps. Refer to the OMM for the specific engine for additional information.

 **NOTES:** Add Cat ELC Extender at the half-life of the coolant drain interval. These drain intervals are only achievable with annual Level 2 coolant analysis.



### 5-3.2.1 Glycol

Glycol in the coolant helps to provide protection against the following conditions:

- Boiling
- Freezing
- Cavitation of the water pump and cylinder liners

For optimum performance, Caterpillar recommends a 1:1 mixture of a water/glycol solution.



**NOTE:** Use a mixture that will provide protection against the lowest ambient temperature.



**NOTE:** 100 percent pure glycol will freeze at a temperature of -23°C (-9°F).

Refer to the following two tables for additional information.

Most conventional heavy-duty coolant/antifreezes use ethylene glycol. Propylene glycol may also be used. In a 1:1 mixture with water, ethylene and propylene glycol provide similar protection against freezing and boiling. Refer to the following two tables for additional information.

Ethylene Glycol		
Concentration	Freeze Protection	Boil Protection
50 Percent	-37°C (-34°F)	106°C (223°F)
60 Percent	-51°C (-60°F)	111°C (232°F)

Propylene Glycol		
Concentration	Freeze Protection	Boil Protection
50 Percent	-32°C (-26°F)	106°C (223°F)



**NOTICE:** Do not use propylene glycol in concentrations that exceed 50 percent glycol because of propylene glycol's reduced heat transfer capability. Use ethylene glycol in conditions that require additional protection against boiling or freezing.

To check the concentration of glycol, use the 1U-7298 Coolant/Battery Tester (Degree Celsius) or use the 1U-7297 Coolant/Battery Tester (Degree Fahrenheit). The testers give readings that are immediate and accurate. The testers can be used with ethylene or propylene glycol.



**NOTE:** Propylene glycol coolant used in Caterpillar Diesel Engine cooling systems must meet "ASTM D6211-98a Fully-Formulated Propylene Glycol-Based Engine Coolant for Heavy-Duty Engines". When Propylene glycol is used in heavy-duty diesel engines, regular addition of Supplemental Coolant Additive (SCA) is required for liner cavitation protection. Consult your Caterpillar dealer for more information.

### 5-3.2.2 S • O • S Coolant Analysis

Recommended Interval		
Type of Coolant	Level 1	Level 2
DEAC	Every 250 Hours	Yearly <sup>(1)</sup>
ELC	Not Required	Yearly

(1) The Level 2 Coolant Analysis should be performed sooner if a problem is identified by a Level 1 Coolant Analysis.

Testing the engine coolant is important to ensure that the engine is protected from internal cavitation and from corrosion. The analysis also tests the ability of the coolant to protect the engine from boiling and from freezing. The S • O • S Coolant Analysis can be done at your Caterpillar dealer. Caterpillar S • O • S Coolant Analysis is the best way to monitor the condition of your coolant and your cooling system. S • O • S Coolant Analysis is a program that is based on periodic samples.

### 5-3.2.3 Refill Capacity (Coolant System)

The total cooling system capacity will vary depending on the radiator that is installed in the coach. The table for the capacity of the cooling system is blank. The customer should fill in the table and keep for their records.

#### Approximate Capacity of the Cooling System

Compartment or System	Liters	Quarts
Total Cooling System <sup>(1)</sup>		

(1) The total cooling system capacity includes the following components the engine block, the radiator, and all coolant hoses and lines.

## 5-3.3 Maintenance Interval Schedule for C13 Engines with Standard/Deep Oil Sumps

**!!!IMPORTANT: Ensure that the Safety Information, Warnings, and Instructions are read and understood before operation or maintenance procedures are performed.**



**NOTE:** Use fuel consumption, service hours, or calendar time, whichever occurs first, in order to determine the maintenance intervals. Engines that operate in severe operating conditions may require more frequent maintenance.

Before each consecutive interval is performed, all of the maintenance requirements from the previous interval must be performed.



**NOTE:** Some maintenance items are for optional equipment.

Instructions for performing the following procedures may be found later in the manual after these schedules.

#### When Required

Battery	Replace
Battery or Battery Cable	Disconnect
Engine Air Cleaner Element	Clean/Replace
Engine Oil Level Gauge	Calibrate
Fuel System	Prime
Severe Service Application	Check

#### Daily

Cooling System Coolant Level	Check
Engine Air Cleaner Service Indicator	Inspect
Engine Oil Level	Check
Fuel System Primary Filter/Water Separator	Drain
Fuel System Water Separator	Drain
Walk-Around Inspection	Inspect

**PM Level 1 - Every 48 000 km (30 000 miles) or 17 400 L (4600 US gal) of Fuel or 600 Service Hours**

Air Compressor Filter	Clean/Replace
Alternator	Inspect
Battery Electrolyte Level	Check
Belt	Inspect
Belt Tensioner	Inspect
Cooling System Supplemental Coolant Additive (SCA)	Test/Add
Cylinder Head Grounding Stud	Inspect/Clean/Tighten
Engine Crankcase Breather	Clean
Engine Oil Sample	Obtain
Engine Oil and Filter	Change
Fuel System Primary Filter	Clean/Replace
Fuel System Secondary Filter	Replace
Fuel Tank Water and Sediment	Drain
Hoses and Clamps	Inspect/Replace

**Between 24 000 and 96 000 km (15 000 and 60 000 miles)**

Compression Brake	Inspect/Adjust
Electronic Unit Injector	Inspect/Adjust
Engine Valve Lash	Inspect/Adjust
Valve Actuators	Inspect/Adjust

**PM Level 2 - Every 320 000 km (200 000 miles) or 125 000 L (33 000 US gal) of Fuel or 4000 Service Hours or 2 Years**

Aftercooler Core	Clean/Test
Cooling System Coolant (DEAC)	Change
Cooling System Water Temperature Regulator	Replace
Fan Drive Bearing	Lubricate
Radiator	Clean

**PM Level 3 - Every 483 000 km (300 000 miles) or 190 000 L (50 000 US gal) of Fuel or 6000 Service Hours or 3 Years**

Air Compressor	Inspect
Compression Brake	Inspect/Adjust/Replace
Crankshaft Vibration Damper	Inspect
Electronic Unit Injector	Inspect/Adjust
Engine	Clean
Engine Valve Lash	Inspect/Adjust
Turbocharger	Inspect
Valve Actuators	Inspect/Adjust

**Every 483 000 km (300 000 miles) or 3 Years**

Cooling System Coolant Extender (ELC)	Add
---------------------------------------	-----

**Every 966 000 km (600 000 miles) or 6 Years**

Cooling System Coolant (ELC)	Change
------------------------------	--------

**PM Level 4 - Every 966 000 km (600 000 miles) or 380 000 L (100 000 US gal) of Fuel or 12 000 Service Hours or 6 Years**

Compression Brake	Inspect/Adjust/Replace
-------------------	------------------------

## 5-3.4 Maintenance Interval Schedule for C13 Engines with Shallow/Optional Oil Sumps and 525 HP RV Ratings

**!!IMPORTANT:** Ensure that the Safety Information, Warnings, and Instructions are read and understood before operation or maintenance procedures are performed.



**NOTE:** Use fuel consumption, service hours, or calendar time, whichever occurs first, in order to determine the maintenance intervals. Engines that operate in severe operating conditions may require more frequent maintenance.

Before each consecutive interval is performed, all of the maintenance requirements from the previous interval must be performed.



**NOTE:** Some maintenance items are for optional equipment.

Instructions for performing the following procedures may be found later in the manual after these schedules.

### When Required

Battery	Replace
Battery or Battery Cable	Disconnect
Engine Air Cleaner Element	Clean/Replace
Engine Oil Level Gauge	Calibrate
Fuel System	Prime
Severe Service Application	Check

### Daily

Cooling System Coolant Level	Check
Engine Air Cleaner Service Indicator	Inspect
Engine Oil Level	Check
Fuel System Primary Filter/Water Separator	Drain
Fuel System Water Separator	Drain
Walk-Around Inspection	Inspect

### PM Level 1 - Every 32 000 km (20 000 miles) or 11 700 L (3100 US gal) of Fuel or 400 Service Hours

Air Compressor Filter	Clean/Replace
Alternator	Inspect
Battery Electrolyte Level	Check
Belt	Inspect
Belt Tensioner	Inspect
Cooling System Supplemental Coolant Additive (SCA)	Test/Add
Cylinder Head Grounding Stud	Inspect/Clean/Tighten
Engine Crankcase Breather	Clean
Engine Oil Sample	Obtain
Engine Oil and Filter	Change
Fuel System Primary Filter	Clean/Replace
Fuel System Secondary Filter	Replace
Fuel Tank Water and Sediment	Drain
Hoses and Clamps	Inspect/Replace

**Between 24 000 and 96 000 km (15 000 and 60 000 miles)**

Electronic Unit Injector	Inspect/Adjust
Engine Valve Lash	Inspect/Adjust
Valve Actuators	Inspect/Adjust

**PM Level 2 - Every 320 000 km (200 000 miles) or 125 000 L (33 000 US gal) of Fuel or 4000 Service Hours or 2 Years**

Aftercooler Core	Clean/Test
Cooling System Coolant (DEAC)	Change
Cooling System Water Temperature Regulator	Replace
Fan Drive Bearing	Lubricate
Radiator	Clean

**PM Level 3 - Every 483 000 km (300 000 miles) or 190 000 L (50 000 US gal) of Fuel or 6000 Service Hours or 3 Years**

Air Compressor	Inspect
Crankshaft Vibration Damper	Inspect
Electronic Unit Injector	Inspect/Adjust
Engine	Clean
Engine Valve Lash	Inspect/Adjust
Turbocharger	Inspect
Valve Actuators	Inspect/Adjust

**Every 483 000 km (300 000 miles) or 3 Years**

Cooling System Coolant Extender (ELC)	Add
---------------------------------------	-----

**Every 966 000 km (600 000 miles) or 6 Years**

Cooling System Coolant (ELC)	Change
------------------------------	--------

**5-3.5 Aftercooler Core - Clean/Test (Air-To-Air Aftercooler)**

The air-to-air aftercooler is OEM installed in many applications. Please refer to the OEM specifications for information that is related to the aftercooler.

**5-3.6 Air Compressor - Inspect****WARNING!!**

Do not disconnect the air line from the air compressor governor without purging the air brake and the auxiliary air systems. Failure to purge the air brake and the auxiliary air systems before removing the air compressor and/or the air lines could cause personal injury.

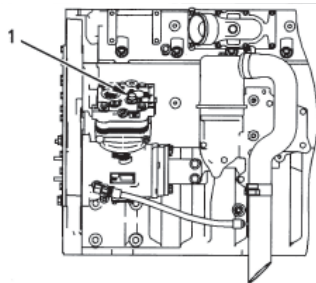
**WARNING!!**

If the air compressor pressure relief valve that is mounted in the air compressor cylinder head is bypassing compressed air, there is a malfunction in the air system, possibly ice blockage. Under these conditions, your engine may have insufficient air for normal brake operation.

Do not operate the engine until the reason for the air bypass is identified and corrected. Failure to heed this warning could lead to property damage, personal injury, or death to the operator or bystanders.

The function of the pressure relief valve is to bypass air when there is a malfunction in the system for the air compressor. The pressure relief valve for the air compressor releases air at 1723 kPa (250 psi). If the pressure relief valve for the air compressor exhausts, all personnel should be at a safe distance away from the air compressor. All personnel should also stay clear of the air compressor when the engine is operating and the air compressor is exposed.

Consult your Caterpillar dealer for assistance.

### 5-3.7 Air Compressor Filter - Clean/Replace (If Equipped)

One of the single most important aspects of preventative maintenance for the air compressor is the induction of clean air. The type of maintenance that is required for the air compressor and the maintenance interval depends on the type of air induction system that is used. Operating conditions (dust, dirt and debris) may require more frequent service.

### 5-3.8 Alternator - Inspect

Caterpillar recommends a scheduled inspection of the alternator. Inspect the alternator for loose connections and proper battery charging.

Check the alternator and the battery charger for proper operation. If the batteries are properly charged, the ammeter reading should be very near zero. All batteries should be kept charged. The batteries should be kept warm because temperature affects the cranking power. If the battery is too cold, the battery will not crank the engine. The battery will not crank the engine, even if the engine is warm. When the engine is not run for long periods of time or if the engine is run for short periods, the batteries may not fully charge. A battery with a low charge will freeze more easily than a battery with a full charge.

### 5-3.9 Battery - Replace

**WARNING!!**

**Batteries give off combustible gases which can explode. A spark can cause the combustible gases to ignite. This can result in severe personal injury or death.**

**Ensure proper ventilation for batteries that are in an enclosure. Follow the proper procedures in order to help prevent electrical arcs and/or sparks near batteries. Do not smoke when batteries are serviced.**

**WARNING!!**

**The battery cables or the batteries should not be removed with the battery cover in place. The battery cover should be removed before any servicing is attempted.**

**Removing the battery cables or the batteries with the cover in place may cause a battery explosion resulting in personal injury.**

1. Turn the key start switch to the OFF position. Remove the key and all electrical loads.
2. Turn OFF the battery charger. Disconnect the charger.
3. The NEGATIVE “-” cable connects the NEGATIVE “-” battery terminal to the ground plane. Disconnect the cable from the NEGATIVE “-” battery terminal.
4. The POSITIVE “+” cable connects the POSITIVE “+” battery terminal to the starting motor. Disconnect the cable from the POSITIVE “+” battery terminal.



**NOTE:** Always recycle a battery. Never discard a battery. Return used batteries to an appropriate recycling facility.

5. Remove the used battery.
6. Install the new battery.



**NOTE:** Before the cables are connected, ensure that the key start switch is OFF.

7. Connect the cable from the starting motor to the POSITIVE “+” battery terminal.
8. Connect the cable from the ground plane to the NEGATIVE “-” battery terminal.

## 5-3.10 Battery Electrolyte Level - Check

When the engine is not run for long periods of time or when the engine is run for short periods, the batteries may not fully recharge. Ensure a full charge in order to help prevent the battery from freezing. If batteries are properly charged, ammeter reading should be very near zero.

### **WARNING!!**

**All lead-acid batteries contain sulfuric acid which can burn the skin and clothing. Always wear a face shield and protective clothing when working on or near batteries.**

1. Remove the filler caps. Maintain the electrolyte level to the "FULL" mark on the battery.
2. If the addition of water is necessary, use distilled water. If distilled water is not available use clean water that is low in minerals. Do not use artificially softened water.
3. Check the condition of the electrolyte with the 1U-7298 Coolant/Battery Tester (°C) or the 1U-7297 Coolant/Battery Tester (°F).
4. Keep the batteries clean.

Clean the battery case with one of the following cleaning solutions.

- A mixture of 0.1 kg (0.2 lb) of baking soda and 1 L (1 qt) of clean water
- A mixture of 0.1 L (0.11 qt) of ammonia and 1 L (1 qt) of clean water

Thoroughly rinse the battery case with clean water.

Use a fine grade of sandpaper to clean the terminals and the cable clamps. Clean the items until the surfaces are bright and shiny. DO NOT remove material excessively. Excessive removal of material can cause the clamps to not fit properly. Coat the clamps and the terminals with 5N-5561 Silicone Lubricant, petroleum jelly or MPM grease.

## 5-3.11 Battery or Battery Cable - Disconnect

### **WARNING!!**

**The battery cables or the batteries should not be removed with the battery cover in place. The battery cover should be removed before any servicing is attempted.**

**Removing the battery cables or the batteries with the cover in place may cause a battery explosion resulting in personal injury.**

1. Turn the start switch to the OFF position. Turn the ignition switch (if equipped) to the OFF position and remove the key and all electrical loads.
2. Disconnect the negative battery terminal at the battery that goes to the start switch. Ensure that the cable cannot contact the terminal. When four 12 volt batteries are involved, the negative side of two batteries must be disconnected.
3. Tape the leads in order to help prevent accidental starting.
4. Proceed with necessary system repairs. Reverse the steps in order to reconnect all of the cables.

## 5-3.12 Belt - Inspect

### 5-3.12.1 Inspection

Belt tension should be checked initially between the first 20 to 40 hours of engine operation.

After the initial check, the belt tension should be checked at Every PM Level 1 or Three Months.

To maximize the engine performance, inspect the belts for wear and for cracking. Replace belts that are worn or damaged.

For applications that require multiple drive belts, replace the belts in matched sets. Replacing only one belt of a matched set will cause the new belt to carry more load because the older belt is stretched. The additional load on the new belt could cause the new belt to break.

If the belts are too loose, vibration causes unnecessary wear on the belts and pulleys. Loose belts may slip enough to cause overheating.

If the belts are too tight, unnecessary stresses are placed on the pulley bearings and on the belts. This may shorten the service life of the components.

Remove the belt guard. Inspect the condition and adjustment of the alternator belts and accessory drive belts (if equipped).

To check the belt tension, apply 110 N•m (25 lb ft) of force midway between the pulleys. A correctly adjusted belt will deflect 9 mm (0.35 inch) to 15 mm (0.59 inch).

If the belt does not require replacement or adjustment, install the belt guard. If the belt requires adjustment or replacement, perform the following procedure to adjust the belt tension.

- If the engine is equipped with a refrigerant compressor (air conditioner), the belt for the fan drive, the alternator, and the accessories will have an automatic belt tensioner.
- If the engine is not equipped with a refrigerant compressor, the alternator is used to adjust the belt tension.

### 5-3.12.2 Adjustment

#### Alternator Belt

1. Slightly loosen mounting bolt (2) and adjusting nut (1).
2. Move the pulley in order to adjust the belt tension.
3. Tighten adjusting nuts (1) and mounting bolts (2). Refer to *"Torque Specifications"* section of this manual.
4. Install the belt guard.

If new belts are installed, check the belt tension again after 30 minutes of engine operation at the rated rpm.

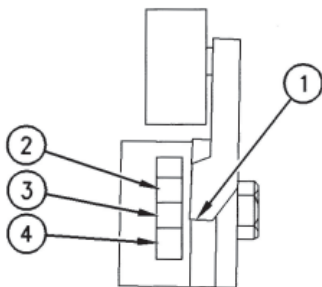
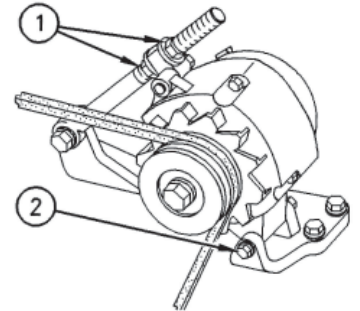

Side view of the belt tensioner

- (1) Indicator
- (2) Upper red zone
- (3) Green zone
- (4) Lower red zone

### 5-3.13 Belt Tensioner - Inspect

It is essential to check the position of the belt tightener in order to maintain the proper belt tension. A film (decal) is located on the side of the belt tightener. The decal indicates when the belts have stretched beyond the belt tightener's ability.

If the pointer (1) is in green zone (3), the belt tension is correct. If the pointer (1) is in the upper red zone (2), the belt has stretched. The tension must be adjusted or the belt must be replaced. If the pointer (1) is in the lower red zone (4), the belt is too short. The belt must be replaced.



## 5-3.14 Compression Brake - Inspect/Adjust

S/N: BXS1-Up

The maintenance of the compression brake should be performed in conjunction with scheduled engine maintenance. The correct tune-up kit is required when parts are replaced on the compression brake.



**NOTE:** The slave piston lash adjustment must be performed after the engine valve lash adjustment is performed. Make the slave piston adjustment while the engine is stopped. Refer to the Systems Operation, Testing and Adjusting module for additional information.

Component	Required Maintenance
Wiring and Terminal Connections	Inspect
Clutch/Throttle/Buffer Screw	Adjust
Slave Piston Lash Adjusting Screw	Adjust/Inspect
Solenoid Valves	Inspect
Crosshead Bridges/Valve Stem Caps	Inspect
Injector/Exhaust Rocker Arm Screws	Inspect
Master Piston/Fork Assembly	Inspect
Slave pistons	Inspect
External Hose Assembly	Inspect
Housings	Inspect
Fuel Pipes	Inspect
Hold Down Bolts	Inspect
Accumulator Springs <sup>(1)</sup>	Inspect
Solenoid Harness <sup>(1)</sup>	Inspect
Solenoid Seal Rings <sup>(1)</sup>	Inspect
Control Valve Springs <sup>(1)</sup>	Inspect
Control Valves <sup>(1)</sup>	Inspect
Oil Seal Rings <sup>(1)</sup>	Inspect
Master Piston Return Springs <sup>(1)</sup>	Inspect
Terminal Lead Out <sup>(1)</sup>	Inspect
Crosshead Pin Assembly <sup>(1)</sup>	Inspect

## 5-3.15 Compression Brake - Inspect/Adjust/Replace

S/N: BXS1-Up

The maintenance of the compression brake should be performed in conjunction with scheduled engine maintenance. The correct tune-up kit is required when parts are replaced on the compression brake.



**NOTE:** The slave piston lash adjustment must be performed after the engine valve lash adjustment is performed. Make the slave piston adjustment while the engine is stopped. Refer to the [Systems Operation, Testing and Adjusting Module](#) for additional information.

Refer to the [Disassembly and Assembly Module](#) for instructions on replacing the components.

Component	Required Maintenance	Required Maintenance
	(300,000 miles)	(600,000 miles)
Wiring and Terminal Connections	Inspect	Inspect
Clutch/Throttle/Buffer Screw	Adjust/Replace	Adjust/Replace
Slave Piston Lash Adjusting Screw	Adjust/Inspect	Adjust/Inspect
Solenoid Valves	Inspect	Replace
Crosshead Bridges/Valve Stem Caps	Inspect	Inspect
Injector/Exhaust Rocker Arm Screws	Inspect	Inspect
Master Piston/Fork Assembly	Inspect	Inspect
Slave pistons	Inspect	Inspect
External Hose Assembly	Inspect	Inspect
Housings	Inspect	Inspect
Fuel Pipes	Inspect	Inspect
Hold Down Bolts	Inspect	Replace
Accumulator Springs <sup>(1)</sup>	Replace	Inspect
Solenoid Harness <sup>(1)</sup>	Replace	Inspect
Solenoid Seal Rings <sup>(1)</sup>	Replace	Inspect
Control Valve Springs <sup>(1)</sup>	Replace	Inspect
Control Valves <sup>(1)</sup>	Replace	Inspect
Oil Seal Rings <sup>(1)</sup>	Replace	Inspect
Master Piston Return Springs <sup>(1)</sup>	Replace	Inspect
Terminal Lead Out <sup>(1)</sup>	Replace	Inspect
Crosshead Pin Assembly <sup>(1)</sup>	Replace	Inspect

## 5-3.16 Cooling System Coolant (DEAC) - Change

Clean the cooling system and flush the cooling system before the recommended maintenance interval if the following conditions exist:

- The engine overheats frequently.
- Foaming is observed.
- The oil has entered the cooling system and the coolant is contaminated.
- The fuel has entered the cooling system and the coolant is contaminated.



**NOTICE:** Use of commercially available cooling system cleaners may cause damage to cooling system components. Use only cooling system cleaners that are approved for Caterpillar engines.



**NOTE:** Inspect the water pump and the water temperature regulator after the cooling system has been drained. This is a good opportunity to replace the water pump, the water temperature regulator and the hoses, if necessary.

### 5-3.16.1 Drain

#### **WARNING!!**

**Pressurized System - Hot coolant can cause serious burns. To open the cooling system filler cap, stop the engine and wait until the cooling system components are cool. Loosen the cooling system pressure cap slowly in order to relieve the pressure.**

1. Stop the engine and allow the engine too cool. Loosen the cooling system filler cap slowly in order to relieve any pressure. Remove the cooling system filler cap.
2. Open the cooling system drain valve (if equipped). If the cooling system is not equipped with a drain valve, remove one of the drain plugs.



**NOTE:** If equipped, be sure to drain the heater and any related supply and return lines.

Allow the coolant to drain.



**NOTICE:** Dispose of used engine coolant properly or recycle. Various methods have been proposed to reclaim used coolant or reuse in engine cooling systems. The full distillation procedure is the only method acceptable by Caterpillar to reclaim the used coolant.

For information regarding the disposal and recycling of used coolant, consult your Caterpillar dealer or consult

#### **Caterpillar Service Technology Group:**

Outside Illinois: 1-800-542-TOOL

Inside Illinois: 1-800-541-TOOL

Canada: 1-800-523-TOOL

### 5-3.16.2 Flush

1. Flush the cooling system with clean water in order to remove any debris.
2. Close the drain valve (if equipped). Clean the drain plugs. Install the drain plugs.



**NOTICE:** Fill the cooling system no faster than 19 L (5 US gal) per minute to avoid air locks.

3. Fill the cooling system with a mixture of clean water and Caterpillar Fast Acting Cooling System Cleaner. Add 0.5 L (1 pint) of cleaner per 15 L (4 US gal) of the cooling system capacity. Install the cooling system filler cap.
4. Start and run the engine at low idle for a minimum of 30 minutes. The coolant temperature should be at least 82 °C (180 °F).



**NOTICE:** Improper or incomplete rinsing of the cooling system can result in damage to copper and other metal components.

To avoid damage to the cooling system, make sure to completely flush the cooling system with clear water. Continue to flush the system until all signs of the cleaning agent are gone.

5. Stop the engine and allow the engine to cool. Loosen the cooling system filler cap slowly in order to relieve any pressure. Remove the cooling system filler cap. Open the drain valve (if equipped) or remove the cooling system drain plugs. Allow the water to drain. Flush the cooling system with clean water. If equipped, be sure to flush the heater and any related supply and return lines. Close the drain valve (if equipped). Clean the drain plugs. Install the drain plugs to the specified torque.

### 5-3.16.3 Cooling Systems with Heavy Deposits or Plugging



**NOTE:** For the following procedure to be effective, there must be some active flow through the cooling system components.

1. Flush the cooling system with clean water in order to remove any debris.



**NOTE:** If equipped, be sure to flush the heater and any related supply and return lines.

2. Close the drain valve (if equipped). Clean the drain plugs. Install the drain plugs to the specified torque.



**NOTICE:** Fill the cooling system no faster than 19 L (5 US gal) per minute to avoid air locks.

3. Fill the cooling system with a mixture of clean water and Caterpillar Fast Acting Cooling System Cleaner. Add 0.5 L (1 pint) of cleaner per 3.8 to 7.6 L (1 to 2 US gal) of the cooling system capacity. Install the cooling system filler cap.
4. Start and run the engine at low idle for a minimum of 90 minutes. The coolant temperature should be at least 82 °C (180 °F).



**NOTICE:** Improper or incomplete rinsing of the cooling system can result in damage to copper and other metal components.

To avoid damage to the cooling system, make sure to completely flush the cooling system with clear water. Continue to flush the system until all signs of the cleaning agent are gone.

5. Stop the engine and allow the engine to cool. Loosen the cooling system filler cap slowly in order to relieve any pressure. Remove the cooling system filler cap. Open the drain valve (if equipped) or remove the cooling system drain plugs. Allow the water to drain. Flush the cooling system with clean water. Close the drain valve (if equipped). Clean the drain plugs. Install the drain plugs to the specified torque.

### 5-3.16.4 Fill



**NOTICE:** Fill the cooling system no faster than 19 L (5 US gal) per minute to avoid air locks.

1. Fill the cooling system with coolant/antifreeze. Refer to “*Refill Capacities and Recommendations*” section of this manual for more information on cooling system specifications. Do not install the cooling system filler cap.
2. Start and run the engine at low idle. Increase the engine rpm to 1500 rpm. Run the engine at high idle for one minute in order to purge the air from the cavities of the engine block. Stop the engine.
3. Check the coolant level. Maintain the coolant level within 13 mm (0.5 inch) below the bottom of the pipe for fitting. Maintain the coolant level within 13 mm (0.5 inch) to the proper level on the sight glass (if equipped).
4. Clean the cooling system filler cap. Inspect the gasket that is on the cooling system filler cap. If the gasket that is on the cooling system filler cap is damaged, discard the old cooling system filler cap and install a new cooling system filler cap. If the gasket that is on the cooling system filler cap is not damaged, perform a pressure test. A 9S-8140 Pressurizing Pump is used to perform the pressure test. The correct pressure for the cooling system filler cap is stamped on the face of the cooling system filler cap. If the cooling system filler cap does not retain the correct pressure, install a new cooling system filler cap.
5. Start the engine. Inspect the cooling system for leaks and for proper operating temperature.

### 5-3.17 Cooling System Coolant (ELC) - Change

Clean the cooling system and flush the cooling system before the recommended maintenance interval if the following conditions exist:

- The engine overheats frequently.
- Foaming is observed.
- The oil has entered the cooling system and the coolant is contaminated.
- The fuel has entered the cooling system and the coolant is contaminated.



**NOTE:** When the cooling system is cleaned, only clean water is needed when the ELC is drained and replaced.



**NOTE:** Inspect the water pump and the water temperature regulator after the cooling system has been drained. This is a good opportunity to replace the water pump, the water temperature regulator and the hoses, if necessary.

#### 5-3.17.1 Drain

##### **WARNING!!**

**Pressurized System - Hot coolant can cause serious burns. To open the cooling system filler cap, stop the engine and wait until the cooling system components are cool. Loosen the cooling system pressure cap slowly in order to relieve the pressure.**

1. Stop the engine and allow the engine to cool. Loosen the cooling system filler cap slowly in order to relieve any pressure. Remove the cooling system filler cap.
2. Open the cooling system drain valve (if equipped). If the cooling system is not equipped with a drain valve, remove the cooling system drain plugs.  
Allow the coolant to drain.



**NOTICE:** Dispose of used engine coolant properly or recycle. Various methods have been proposed to reclaim used coolant for reuse in engine cooling systems. The full distillation procedure is the only method acceptable by Caterpillar to reclaim the used coolant.

For information regarding the disposal and the recycling of used coolant, consult your Caterpillar dealer or consult

##### **Caterpillar Service Technology Group:**

- Outside Illinois: 1-800-542-TOOL
- Inside Illinois: 1-800-541-TOOL
- Canada: 1-800-523-TOOL

### 5-3.17.2 Flush

1. Flush the cooling system with clean water in order to remove any debris.



**NOTE:** If equipped, be sure to flush the heater and any related supply and return lines.

2. Close the drain valve (if equipped). Clean the drain plugs. Install the drain plugs to the specified torque.



**NOTICE:** Fill the cooling system no faster than 19 L (5 US gal) per minute to avoid air locks.

3. Fill the cooling system with clean water. Install the cooling system filler cap.
4. Start and run the engine at low idle until the temperature reaches 49 to 66°C (120 to 150°F).
5. Stop the engine and allow the engine to cool. Loosen the cooling system filler cap slowly in order to relieve any pressure. Remove the cooling system filler cap. Open the drain valve (if equipped) or remove the cooling system drain plugs. Allow the water to drain. Flush the cooling system with clean water. Close the drain valve (if equipped). Clean the drain plugs. Install the drain plugs to the specified torque.

### 5-3.17.3 Fill



**NOTICE:** Fill the cooling system no faster than 19 L (5 US gal) per minute to avoid air locks.

1. Fill the cooling system with Extended Life Coolant (ELC). Refer to *“Refill Capacities and Recommendations”* section of this manual for more information on cooling system specifications. Do not install the cooling system filler cap.
2. Start and run the engine at low idle. Increase the engine rpm to high idle. Run the engine at high idle for one minute in order to purge the air from the cavities of the engine block. Stop the engine.
3. Check the coolant level. Maintain the coolant level within 13 mm (0.5 inch) below the bottom of the pipe for filling. Maintain the coolant level within 13 mm (0.5 inch) to the proper level on the sight glass (if equipped.)
4. Clean the cooling system filler cap. Inspect the gasket that is on the cooling system filler cap. If the gasket that is on the cooling system filler cap is damaged, discard the old cooling system filler cap and install a new cooling system filler cap. If the gasket that is on the cooling system filler cap is not damaged, use a 9S-8140 Pressurizing Pump in order to pressure test the cooling system filler cap. The correct pressure for the cooling system filler cap is stamped on the face of the cooling system filler cap. If the cooling system filler cap does not retain the correct pressure, install a new cooling system filler cap.
5. Start the engine. Inspect the cooling system for leaks and for proper operating temperature.

## 5-3.18 Cooling System Coolant Extender (ELC) - Add

Caterpillar Extended Life Coolant (ELC) does not require the frequent Supplemental Coolant Additive (SCA) additions that are associated with the present conventional coolants. The Extender only needs to be added once.

Check the cooling system only when the engine is stopped and cool.

1. Loosen the cooling system filler cap slowly in order to relieve pressure. Remove the cooling system filler cap.
2. It may be necessary to drain enough coolant from the cooling system in order to add the Extender.
3. Add Extender according to the requirements for your engine's cooling system capacity. Refer to the *“Refill Capacities and Recommendations”* section of this manual for the capacity of the cooling system for your engine.
4. Clean the cooling system filler cap. Inspect the gaskets on the cooling system filler cap. Replace the cooling system filler cap if the gaskets for the cooling system filler cap are damaged. Install the cooling system filler cap.

## 5-3.18 Cooling System Coolant Level - Check

Check the coolant level when the engine is stopped and cool.

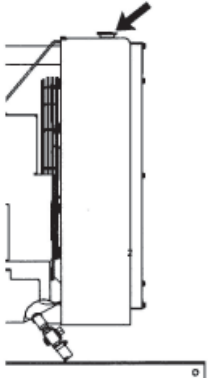

### WARNING!!

**Pressurized System - Hot coolant can cause serious burns. To open the cooling system filler cap, stop the engine and wait until the cooling system components are cool. Loosen the cooling system pressure cap slowly in order to relieve the pressure.**

1. Remove the cooling system filler cap slowly in order to relieve pressure.
2. Maintain the coolant level within 13 mm (0.5 inch) of the bottom of the filler pipe. If the engine is equipped with a sight glass, maintain the coolant level to the proper level in the sight glass.
3. Clean the cooling system filler cap and check the condition of the filler cap gaskets. Replace the cooling system filler cap if the filler cap gaskets are damaged. Reinstall the cooling system filler cap.
4. Inspect the cooling system for leaks.

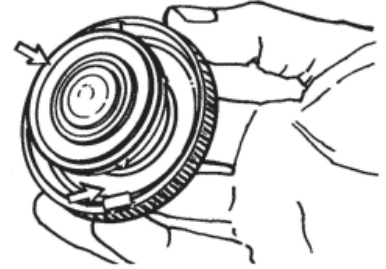

## 5-3.19 Cooling System Supplemental Coolant Additives (SCA) - Test/Add



**NOTICE:** Cooling system coolant additive contains alkali. To help prevent personal injury, avoid contact with the skin and eyes. Do not drink cooling system coolant additive.



**NOTE:** Test the Supplemental Coolant Additive (SCA) or test the SCA concentration as part of the S•O•S Coolant Analysis.

### 5-3.19.1 Test the SCA Concentration

#### Coolant/Antifreeze and SCA



**NOTICE:** Do not exceed the recommended six percent supplemental coolant additive concentration.

### WARNING!!

**Cooling system coolant additive contains alkali. To help prevent personal injury, avoid contact with the skin and the eyes. Do not drink cooling system coolant additive.**

Use the 8T-5296 Coolant Conditioner Test Kit or use the 4C-9301 Coolant Conditioner Test Kit in order to check the concentration of the SCA.

### 5-3.19.2 Add the SCA, If Necessary



**NOTICE:** Do not exceed the recommended amount of supplemental coolant additive concentration. Excessive supplemental coolant additive concentration can form deposits on the higher temperature surfaces of the cooling system, reducing the engine's heat transfer characteristics. Reduced heat transfer could cause cracking of the cylinder head and other high temperature components. Excessive supplemental coolant additive concentration could also result in radiator tube blockage, overheating, and/or accelerated water pump seal wear. Never use both liquid supplemental coolant additive and the spin-on element (if equipped) at the same time. The use of those additives together could result in supplemental coolant additive concentration exceeding the recommended maximum.

#### **WARNING!!**

**Pressurized System - Hot coolant can cause serious burns. To open the cooling system filler cap, stop the engine and wait until the cooling system components are cool. Loosen the cooling system pressure cap slowly in order to relieve the pressure.**

1. Slowly loosen the cooling system filler cap in order to relieve the pressure. Remove the cooling system filler cap.



**NOTE:** Always discard drained fluids according to local regulations.

If necessary, drain some coolant from the cooling system into a suitable container in order to allow space for the extra SCA.

2. Add the proper amount of SCA.
3. Clean the cooling system filler cap. Inspect the gaskets of the cooling system filler cap. If the gaskets are damaged, replace the old cooling system filler cap with a new cooling system filler cap. Install the cooling system filler cap.

### 5-3.20 Cooling System Water Temperature Regulator - Replace

Replace the water temperature regulator before the water temperature regulator fails. This is a recommended preventive maintenance practice. Replacing the water temperature regulator reduces the chances for unscheduled downtime.

A water temperature regulator that fails in a partially opened position can cause overheating or overcooling of the engine.

A water temperature regulator that fails in the closed position can cause excessive overheating. Excessive overheating could result in cracking of the cylinder head or piston seize problems.

A water temperature regulator that fails in the open position will cause the engine operating temperature to be too low during partial load operation. Low engine operating temperatures during partial loads could cause an excessive carbon buildup inside the cylinders. This excessive carbon buildup could result in an accelerated wear of the piston rings and wear of the cylinder liner.



**NOTICE:** Failure to replace your water temperature regulator on a regularly scheduled basis could cause severe engine damage.

Caterpillar engines incorporate a shut design cooling system and require operating the engine with a water temperature regulator installed.

If the water temperature regulator is installed incorrectly, the engine may overheat, causing cylinder head damage.

Ensure that the new water temperature regulator is installed in the original position. Ensure that the water temperature regulator vent hole is open.

Do not use liquid gasket material on the gasket or cylinder head surface.

Consult your Caterpillar dealer for the replacement procedure of the water temperature regulator.



**NOTE:** If only the water temperature regulators are replaced, drain the coolant from the cooling system to a level that is below the water temperature regulator housing.



## 5-3.21 Crankshaft Vibration Damper - Inspect

Damage to the crankshaft vibration damper or failure of the crankshaft vibration damper can increase torsional vibrations. This can result in damage to the crankshaft and to other engine components. A damper that is damaged can cause excessive gear train noise at variable points in the speed range.

The damper is mounted to the crankshaft which is located behind the belt guard on the front of the engine.

### 5-3.21.1 Visconic Damper

The visconic damper has a weight that is located inside a fluid filled case. The weight moves in the case in order to limit torsional vibration.

Inspect the damper for evidence of fluid leaks. If a fluid leak is found, determine the type of fluid. The fluid in the damper is silicone. Silicone has the following characteristics: transparent, viscous, smooth, and difficult to remove from surfaces.

If the fluid leak is oil, inspect the crankshaft seals for leaks. If a leak is observed, replace the crankshaft seals.

Inspect the damper and repair or replacement the damper for any of the following reasons:

- The damper is dented, cracked, or leaking.
- The paint on the damper is discolored from heat.
- The engine has had a failure because of broken crankshaft.
- Analysis of the oil has revealed that the front main bearing is badly worn.
- There is a large amount of gear train wear that is not caused by a lack of oil.

Consult your Caterpillar dealer for information about damper replacement.

## 5-3.22 Cylinder Head Grounding Stud - Inspect/Clean/Tighten

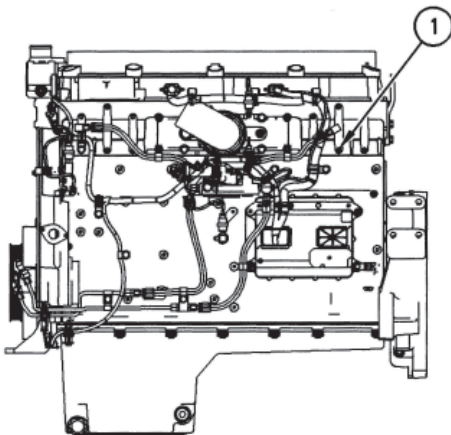

(1) Cylinder head grounding stud

Inspect the OEM vehicle wiring harness for the following conditions:

- Connections that are loose or disconnected
- Mounting hardware that is missing
- Insulation that is chafed or cut
- Wires that are bare

The cylinder head grounding stud must have a wire ground to the battery. Tighten the cylinder head grounding stud at every oil change. Ground wires and straps should be combined at engine grounds. All grounds should be tight and free of corrosion.

1. Clean the cylinder head grounding stud and the terminals for the cylinder head ground strap with a clean cloth.
2. If the connections are corroded, clean the connections with a solution of baking soda and water.
3. Keep the cylinder head grounding stud and the strap clean and coated with MPGM grease or petroleum jelly.

## 5-3.23 Electronic Unit Injector - Inspect/Adjust

**WARNING!!**

Be sure the engine cannot be started while this maintenance is being performed. To prevent possible injury, do not use the starting motor to turn the flywheel.

Hot engine components can cause burns. Allow additional time for the engine to cool before measuring/adjusting the unit injectors.

The electronic unit injectors use high voltage. Disconnect the unit injector enable circuit connector in order to prevent personal injury. Do not come in contact with the injector terminals while the engine is running.

**WARNING!!**

Electrical shock hazard. The electronic unit injector system uses 90-120 volts.

Adjust the electronic unit injector at the same interval as the valve lash adjustment. The operation of Caterpillar engines with improper adjustments of the electronic unit injector can reduce engine efficiency. This reduced efficiency could result in excessive fuel usage and/or shortened engine component life.



**NOTICE:** The camshafts must be correctly timed with the crankshaft before an adjustment of the lash for the fuel injector is made. The timing pins must be removed from the camshafts before the crankshaft is turned or damage to the cylinder block will be the result.

Inspect the adjustment of the lash for the electronic unit injector according to the Systems Operation/Testing and Adjusting “Fuel System” section. Adjust the lash for the electronic unit injector, if necessary.

## 5-3.24 Engine - Clean

**WARNING!!**

Personal injury or death can result from high voltage.

Moisture can create paths of electrical conductivity.

Make sure that the electrical system is OFF. Lock out the starting controls and tag the controls “DO NOT OPERATE”.



**NOTICE:** Accumulated grease and oil on an engine is a fire hazard. Keep the engine clean. Remove debris and fluid spills whenever a significant quantity accumulates on the engine.

Periodic cleaning of the engine is recommended. Steam cleaning the engine will remove accumulated oil and grease. A clean engine provides the following benefits:

- Easy detection of fluid leaks
- Maximum heat transfer characteristics
- Ease of maintenance



**NOTE:** Caution must be used in order to prevent electrical components from being damaged by excessive water when you clean the engine. Avoid electrical components such as the alternator, the starter, and the ECM.

## 5-3.25 Engine Air Cleaner Element - Clean/Replace



**NOTICE:** Never service the air cleaner element with the engine running since this will allow dirt to enter the engine.

If the air cleaner element becomes plugged, the air can split the material out of the air cleaner element. Unfiltered air will drastically accelerate internal engine wear.

- Operating conditions (dust, dirt and debris) may require more frequent service of the air cleaner element.
- The air cleaner element should be replaced at least one time per year. This replacement should be performed regardless of the number of cleanings.

Replace the dirty paper air cleaner elements with clean air cleaner elements. Before installation, the air cleaner elements should be thoroughly checked for tears and/or holes in the filter material. Inspect the gasket or the seal of the air cleaner element for damage. Maintain a supply of suitable air cleaner elements for replacement purposes.

Your Caterpillar dealer has the proper air cleaner elements for your application. Consult your Caterpillar dealer for the correct air cleaner element or follow the instructions that are provided by the OEM.

## 5-3.26 Engine Air Cleaner Service Indicator - Inspect (If Equipped)

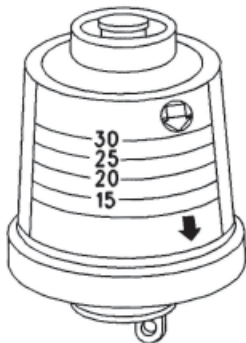

Typical service indicator

Some engines may be equipped with a different service indicator.

Some engines are equipped with a differential gauge for inlet air pressure. The differential gauge for inlet air pressure displays the difference in the pressure that is measured before the air cleaner element and the pressure that is measured after the air cleaner element. As the air cleaner element becomes dirty, the pressure differential rises. If your engine is equipped with a different type of service indicator, follow the OEM recommendations in order to service the air cleaner service indicator.

The service indicator may be mounted on the air cleaner housing or in a remote location.

Observe the service indicator. The air cleaner element should be cleaned or the air cleaner element should be replaced when one of the following conditions occur:

- The yellow diaphragm enters the red zone.
- The red piston locks in the visible position.

### 5-3.26.1 Test the Service Indicator

Service indicators are important instruments.

- Check for ease of resetting. The service indicator should reset in less than three pushes.
- Check the movement of the yellow core when the engine is accelerated to the engine rated speed. The yellow core should latch approximately at the greatest vacuum that is attained.

If the service indicator does not reset easily, or if the yellow core does not latch at the greatest vacuum, the service indicator should be replaced. If the new service indicator will not reset, the hole for the service indicator may be plugged.

The service indicator may need to be replaced frequently in environments that are severely dusty, if necessary. Replace the service indicator annually regardless of the operating conditions. Replace the service indicator when the engine is overhauled, and whenever major engine components are replaced.



**NOTE:** When a new service indicator is installed, excessive force may crack the top of the service indicator. Tighten the service indicator to a torque of 2 N•m (18 lb in).

## 5-3.27 Engine Crankcase Breather - Clean

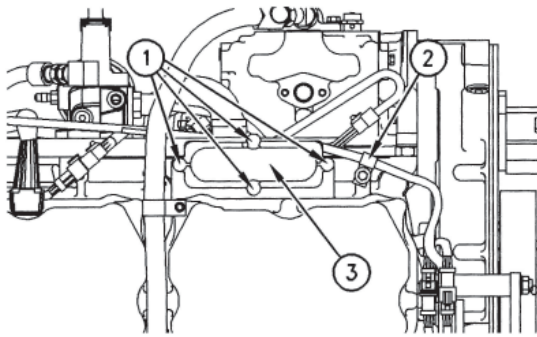

(1) Bolts (2) Hose Clamp (3) Breather Cover



**NOTICE:** Perform this maintenance with the engine stopped.

If the crankcase breather is not maintained on a regular basis, the crankcase breather will become plugged. A plugged crankcase breather will cause excessive crankcase pressure that may cause crankshaft seal leakage.

1. Loosen hose clamp (2) and remove the hose from breather cover (3).
2. Loosen four bolts (1) for the breather cover and remove breather cover (3).
3. Remove the breather element and wash the breather element in solvent that is clean and nonflammable. Allow the element to dry.

4. Install a breather element that is clean and dry. Install breather cover (3) and install bolts (1).
5. Install the hose. Install hose clamp (2).

## 5-3.28 Engine Crankcase Breather - Clean



**NOTICE:** Perform this maintenance with the engine stopped.

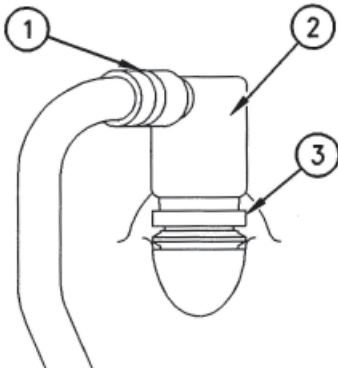

Typical Example

- (1) Hose Clamp
- (2) Breather Assembly
- (3) Retaining Clamp

If the crankcase breather is not maintained on a regular basis, the crankcase breather will become plugged. A plugged crankcase breather will cause excessive crankcase pressure that may cause crankshaft seal leakage.

1. Loosen hose clamp (1) and remove the hose from breather assembly (2).
2. Loosen the retaining clamp (3). Remove breather assembly (2) and the seal.
3. Wash the breather element in solvent that is clean and nonflammable. Allow the breather element to dry before installation.
4. Install a breather element that is clean and dry. Install breather assembly and seal (2) and install (3) to the specified torque.
5. Install the hose. Install hose clamp (1) to the specified torque.

## 5-3.29 Engine Oil Level - Check

### WARNING!!

Hot oil and hot components can cause personal injury. Do not allow hot oil or hot components to contact the skin.



**NOTE:** The location of the oil level gauge and the oil filler cap will vary with the model.

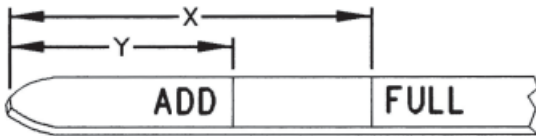

(Y) "ADD" mark (X) "FULL" mark



**NOTICE:** Perform this maintenance with the engine stopped.

1. Maintain the oil level between "ADD" mark (Y) and "FULL" mark (X) on the oil level gauge. Do not fill the crankcase above "FULL" mark (X).



**NOTICE:** Engine damage can occur if the crankcase is filled above the "FULL" mark on the oil level gauge (dipstick).

An overfull crankcase can cause the crankshaft to dip into the oil. This will reduce the power that is developed and also force air bubbles into the oil. These bubbles (foam) can cause the following problems: reduction of the oil's ability to lubricate, reduction of oil pressure, inadequate cooling, oil blowing out of the crankcase breathers, and excessive oil consumption.

Excessive oil consumption will cause deposits to form on the pistons and in the combustion chamber. Deposits in the combustion chamber lead to the following problems: guttering of the valves, packing of carbon under the piston rings, and wear of the cylinder liner.

If the oil level is above the "FULL" mark on the oil level gauge, drain some of the oil immediately.

2. Remove the oil filler cap and add oil, if necessary. For the correct oil to use, see "[Engine Oil](#)" section in this manual. Do not fill the crankcase above "FULL" mark (X) on the oil level gauge. Clean the oil filler cap. Install the oil filler cap.
3. Record the amount of oil that is added. For the next oil sample and analysis, include the total amount of oil that has been added since the previous sample. This will help to provide the most accurate oil analysis.

## 5-3.30 Engine Oil Level Gauge - Calibrate (Optional-Shallow)

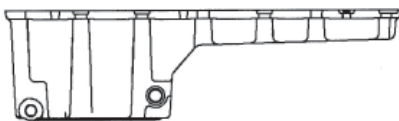

240-3277 Pan (Optional-Shallow) - This pan has an overall height of 278 mm (10.9 inch).

### 5-3.31.1 Check Calibration at the First Oil Change

The engine oil level will vary depending on the angle and the slant of the engine installation. The angle is the front to back tilt. The slant is the sideways tilt.

The oil level gauge markings must be verified in order to ensure that it is correct. Verify the oil level gauge markings at the first oil change.

Verify the "ADD" mark and verify the "FULL" mark that is on the oil level gauge. Use the following procedure.



**NOTICE:** The vehicle must be parked on a level surface in order to perform this maintenance procedure.

1. Operate the engine until normal operating temperature is achieved. Stop the engine. Remove the crankcase oil drain plugs. The oil drain plug from the deep portion of the oil pan should be removed. The oil drain plug from the shallow portion of the oil pan should be removed. This will allow all of the oil to drain. Drain the oil from the crankcase for 20 minutes.
2. Remove the used oil filter(s). Install the new oil filter(s). Install the oil drain plugs and tighten to  $70 \pm 15 \text{ N} \cdot \text{m}$  ( $50 \pm 11 \text{ lb ft}$ ).



**NOTE:** Your engine may be equipped with auxiliary oil filters. The auxiliary oil filters require a different volume of oil. Refer to the OEM specifications for the auxiliary oil filter.

3. Pour 26 L (28 qt) of oil into the crankcase. Allow enough time for the oil to drain into the crankcase. Approximately 20 minutes should be allowed. Check the oil level. Wait for several minutes and check the oil level again. Proceed after the oil level stops changing.
4. Check the oil level on the oil level gauge. The oil level should be at the “ADD” mark. If the oil level is not at the existing “ADD” mark, grind off the “ADD” mark and engrave the new “ADD” level. Use an engraving pen in order to engrave the new “ADD” mark.
5. Pour 4 L (4 qt) of oil into the crankcase. Allow enough time for the oil to drain into the crankcase.
6. Check the oil level on the oil level gauge. The oil level should be at the “FULL” mark. If the oil level is not at the existing “FULL” mark, grind off the “FULL” mark. Use an engraving pen in order to engrave the new “FULL” mark.



**NOTICE:** Do not crank the engine for more than 30 seconds. Allow the starting motor to cool for two minutes before cranking again.

7. Pour an additional 4 L (4 qt) of oil into the crankcase. Start the engine and run the engine enough to ensure that the lubrication system is filled. Inspect the engine for oil leaks.
8. Stop the engine and allow enough time for the oil to drain into the crankcase.
9. Check the oil level on the oil level gauge. If the oil level is not at the calibrated “FULL” mark, fill the crankcase to the calibrated “FULL” mark. Record the amount of oil that was added. The additional oil and the 34 L (36 qt) of oil that was in the crankcase is the oil capacity of the lubrication system. Record the oil capacity of the lubrication system for future oil changes.

## 5-3.32 Engine Oil Level Gauge - Calibrate (Standard-Deep)

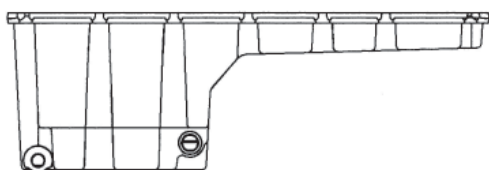

210-1745 Pan (Standard-Deep) - This pan has an overall height of 335 mm (13.2 inch).

### 5-3.32.1 Check Calibration at the First Oil Change

The engine oil level will vary depending on the angle and the slant of the engine installation. The angle is the front to back tilt. The slant is the sideways tilt.

The oil level gauge markings must be verified in order to ensure that they are correct. Verify the oil level gauge markings at the first oil change.

Verify the “ADD” mark and verify the “FULL” mark that is on the oil level gauge. Use the following procedure.



**NOTICE:** The vehicle must be parked on a level surface in order to perform this maintenance procedure.

1. Operate the engine until normal operating temperature is achieved. Stop the engine. Remove the crankcase oil drain plugs. The oil drain plug from the deep portion of the oil pan should be removed. The oil drain plug from the shallow portion of the oil pan should be removed. This will allow all of the oil to drain. Drain the oil from the crankcase for 20 minutes.
2. Remove the used oil filter(s). Install the new oil filter(s). Install the oil drain plugs and tighten to  $70 \pm 15 \text{ N}\cdot\text{m}$  ( $50 \pm 11 \text{ lb ft}$ ).



**NOTE:** Your engine may be equipped with auxiliary oil filters. The auxiliary oil filters require a different volume of oil. Refer to the OEM specifications for the auxiliary oil filter.

3. Pour 32 L (34 qt) of oil into the crankcase. Allow enough time for the oil to drain into the crankcase. Approximately 20 minutes should be allowed. Check the oil level. Wait for several minutes and check the oil level again. Proceed after the oil level stops changing.
4. Check the oil level on the oil level gauge. The oil level should be at the “ADD” mark. If the oil level is not at the existing “ADD” mark, grind off the “ADD” mark and engrave the new “ADD” level. Use an engraving pen in order to engrave the new “ADD” mark.
5. Pour 4 L (4 qt) of oil into the crankcase. Allow enough time for the oil to drain into the crankcase.
6. Check the oil level on the oil level gauge. The oil level should be at the “FULL” mark. If the oil level is not at the existing “FULL” mark, grind off the “FULL” mark. Use an engraving pen in order to engrave the new “FULL” mark.



**NOTICE:** Do not crank the engine for more than 30 seconds. Allow the starting motor to cool for two minutes before cranking again.

7. Pour an additional 4 L (4 qt) of oil into the crankcase. Start the engine and run the engine enough to ensure that the lubrication system is filled. Inspect the engine for oil leaks.
8. Stop the engine and allow enough time for the oil to drain into the crankcase.
9. Check the oil level on the oil level gauge. If the oil level is not at the calibrated "FULL" mark, fill the crankcase to the calibrated "FULL" mark. Record the amount of oil that was added. The additional oil and the 40 L (42 qt) of oil that was in the crankcase is the oil capacity of the lubrication system. Record the oil capacity of the lubrication system for future oil changes.

### 5-3.33 Engine Oil Sample - Obtain

In addition to a good preventative maintenance program, Caterpillar recommends using S•O•S oil analysis at regularly scheduled intervals in order to monitor the condition of the engine and the maintenance requirements of the engine S•O•S oil analysis provides infrared analysis, which is required for determining nitration and oxidation levels.

#### 5-3.33.1 Obtain the Sample and the Analysis

##### **WARNING!!**

**Hot oil and hot components can cause personal injury. Do not allow hot oil or hot components to contact the skin.**

Before you take the oil sample, complete the Label, PEEP5031 for identification of the sample. In order to help obtain the most accurate analysis, provide the following information:

- Engine model
- Service hours on the engine
- The number of hours that have accumulated since the last oil change
- The amount of oil that has been added since the last oil change

To ensure that the sample is representative of the oil in the crankcase, obtain a warm, well mixed oil sample.

To avoid contamination of the oil samples, the tools and the supplies that are used for obtaining oil samples must be clean.

Caterpillar recommends using the sampling valve in order to obtain oil samples. The quality and the consistency of the samples are better when the sampling valve is used. The location of the sampling valve allows oil that is flowing under pressure to be obtained during normal engine operation.

The 169-8373 Fluid Sampling Bottle is recommended for use with the sampling valve. The fluid sampling bottle includes the part that is needed for obtaining oil samples. Instructions are also provided.



**NOTICE:** Always use a designated pump for oil sampling, and use a separate designated pump for coolant sampling. Using the same pump for both types of samples may contaminate the samples that are being drawn. This contaminate may cause a false analysis and an incorrect interpretation that could lead to concerns by both dealers and customers.

If the engine is not equipped with a sampling valve, use the 1U-5718 Vacuum Pump. The pump is designed to accept sampling bottles. Disposable tubing must be attached to the pump for insertion into the sump.

## 5-3.34 Engine Oil and Filter - Change

**WARNING!!** Hot oil and hot components can cause personal injury. Do not allow hot oil or hot components to contact the skin.

Do not drain the engine oil when the engine is cold. As the engine oil cools, suspended waste particles settle on the bottom of the engine oil pan. The waste particles are not removed with the draining cold engine oil. Drain the crankcase while the engine is stopped. Drain the crankcase while the engine oil is warm. This draining method allows the waste particles that are suspended in the engine oil to be drained properly.

Failure to follow this recommended procedure will cause the waste particles to be recirculated through the engine lubrication system with the new engine oil.

### 5-3.34.1 Drain the Engine Oil

After the engine has been run at the normal operating temperature, stop the engine. Use one of the following methods to drain the engine crankcase oil.

**WARNING!!** Hot oil and hot components can cause personal injury. Do not allow hot oil or hot components to contact the skin.



**NOTICE:** The vehicle must be parked on a level surface for this maintenance procedure.

- If the engine is equipped with a drain valve, turn the drain valve knob counterclockwise in order to drain the engine oil. After the engine oil has drained, turn the drain valve knob clockwise in order to close the drain valve.
- If the engine is not equipped with a drain valve, remove the oil drain plug in order to allow the engine oil to drain. If the engine is equipped with a shallow sump, remove the bottom oil drain plugs from both ends of the engine oil pan.

After the engine oil has drained, the oil drain plugs should be cleaned and installed. Tighten the oil drain plugs to the proper torque. Refer to the [Specifications Module "Engine Oil Pan"](#) topic for additional information.



### 5-3.34.2 Replace the Oil Filter



**NOTICE:** Caterpillar oil filters are built to Caterpillar specifications. Use of an oil filter not recommended by Caterpillar could result in severe engine damage to the engine bearings, crankshaft, etc., as a result of the larger waste particles from unfiltered oil entering the engine lubricating system. Only use oil filters recommended by Caterpillar.

1. Remove the oil filter with a 185-3630 Chain Wrench.
2. Cut the oil filter open with a 175-7546 Oil Filter Cutter. Break apart the pleats and inspect the oil filter for metal debris. An excessive amount of metal debris in the oil filter may indicate early wear or a pending failure.



Use a magnet to differentiate between the ferrous metals and the nonferrous metals that are found in the oil filter element. Ferrous metals may indicate wear on the steel and cast iron parts of the engine.

Nonferrous metals may indicate wear on the aluminum parts, brass parts or bronze parts of the engine. Parts that may be affected include the following items: main bearings, rod bearings, turbocharger bearings, and cylinder heads.

Due to normal wear and friction, it is not uncommon to find small amounts of debris in the oil filter. Consult your Caterpillar dealer in order to arrange for a further analysis if an excessive amount of debris is found in the oil filter.

3. Clean the sealing surface of the filter mounting base. Ensure that all of the oil filter gasket is removed.
4. Apply clean engine oil to the new oil filter gasket.



**NOTICE:** Do not fill the oil filters with oil before installing them. This oil would not be filtered and could be contaminated. Contaminated oil can cause accelerated wear to engine components.

5. Install the new oil filter. Tighten the oil filter until the oil filter gasket contacts the base. Tighten the oil filter by hand according to the instructions that are shown on the oil filter. Do not over tighten the oil filter.

### 5-3.34.3 Fill the Engine Crankcase

1. Remove the oil filler cap. Refer to "[Lubricant Specifications](#)" section of this manual for more information. Fill the crankcase with the proper amount of engine oil. Refer to "[Refill Capacities](#)" section of this manual for more information.



**NOTICE:** If equipped with an auxiliary oil filter or system, extra oil must be added when filling the crankcase. Follow the OEM or filter manufacturer's recommendations. If the extra oil is not added, the engine may starve for oil.



**NOTICE:** To help prevent crankshaft or bearing damage, crank engine to fill all filters before starting. Do not crank engine for more than 30 seconds.

1. Start the engine and run the engine at "LOW IDLE" for two minutes. Perform this procedure in order to ensure that the lubrication system has oil and that the oil filters are filled. Inspect the oil filter for oil leaks.
2. Stop the engine and allow the oil to drain back to the sump for a minimum of ten minutes.
3. Remove the oil level gauge in order to check the oil level. Maintain the oil level between the "ADD" and "FULL" marks on the oil level gauge.

### 5-3.34.4 Oil Change Intervals

Many conditions affect the selection of an oil change interval. Some of the conditions that affect the selection of oil are listed: premium API CH-4 multigrade oil, oil analysis at 16,100 km (10,000 miles), and premium oil filters.

Proper oil change intervals are important for maintaining engine service life and engine performance and fully utilizing the lubricant. The engine oil must be able to control the following items: corrosion, oxidation, soot, and wear metals. The engine oil must be able to control the conditions during the time between oil changes. In some severe service applications, reducing the oil change interval may be necessary in order to maintain the integrity of the engine lubricant.

Fuel consumption and oil consumption are the most important factors that are used in order to calculate an oil change interval.

The rate of fuel consumption is a direct result of the load factor of the engine. An engine with a high fuel consumption rate is working harder than an identical engine with a lower fuel consumption rate.

### 5-3.34.5 Tables for Extended Oil Change Intervals

In order to understand the tables for maximum permissible oil change intervals, use the following procedures.

1. Determine the average fuel consumption of the vehicle.
2. Determine the gross vehicle weight (GVW) of the vehicle.
3. Determine the percent of idle time for the vehicle. A download of the histogram data from the ECM can provide a more accurate "percent idle time" measurement. Contact your nearest Caterpillar dealer for information on obtaining data from the ECM.
4. The intersection of the column and the row lists the maximum number of kilometers or miles between oil change intervals.

For example, a C13 Engine with an average fuel consumption of 3 km/L (7 mpg) in a light-duty application will have a maximum permissible oil change interval of 40,250 kilometers (25,000 miles) with a shallow oil sump. The maximum permissible oil change interval for the same situation with a Deep oil sump would be 64,350 km (40,000 miles).

For more information about optimizing oil change intervals, see your Caterpillar dealer.



**NOTE:** Metric units are listed before English units.

The following requirements must be met in order to use Tables 1 and 2:

- Use premium API CH-4 or API CI-4 multigrade oil only. API CH-4 and CI-4 oils are acceptable if the requirements of Caterpillar's ECF-1 (Engine Crankcase Fluid Specification-1) are met. CH-4 and CI-4 oils that have not met the requirements of Caterpillar's ECF-1 Specification may cause reduced engine life.
- DEO Caterpillar multigrade oil is recommended.
- S•O•S Oil analysis is taken at 16,100 km (10,000 mile) intervals and all oil change intervals. The oil analysis must evaluate oil condition, wear metals and soot. Caterpillar's Oil Analysis is preferred. Caterpillar's Oil Analysis is the only oil analysis program with wear tables and limits for soot and oxidation, that are approved by Caterpillar.
- Use premium oil filter(s). Caterpillar 1R-0716 Oil Filter or an oil filter with equivalent performance and durability is recommended.
- Use North American low sulfur diesel fuel (0.05% sulfur).



**NOTE:** Caterpillar cannot guarantee the performance of lubricants or filters that are not made by Caterpillar. Caterpillar cannot guarantee the performance of lubricants or filters that are not sold by Caterpillar. The performance guarantee of any commercially available lubricant is the responsibility of that oil company. The performance guarantee of any commercially available filter is the responsibility of the filter manufacturer.

Table 1

<b>Maximum Permissible Oil Change Intervals for On-Highway C11 and C13 Engines with Optional Shallow Sumps</b>			
	<b>Severe Duty</b>	<b>Normal Duty</b>	<b>Light Duty</b>
<b>Fuel Consumption Kilometers Per Liter (Miles Per Gallon)</b>	Less than 2.6 km/L (6 MPG)	2.6 km/L (6 MPG) to 3 km/L (7 MPG)	Greater than 3 km/L (7 MPG)
<b>Gross Vehicle Weight</b>	More than 80,000 lb	80,000 lb or less	80,000 lb or less
<b>Minimum Oil Sump Capacity<sup>(1)</sup></b>	34 L (36 qt)	34 L (36 qt)	34 L (36 qt)
<b>Idle Time</b>	More than 40%	20% to 40%	Less than 20%
<b>Oil Classification</b>	API CH-4 or API CI-4 <sup>(2)</sup>		
<b>Kilometers (Miles)</b>	24,150 kilometers (15,000 miles)	32,200 kilometers (20,000 miles)	40,250 kilometers (25,000 miles)

- 1) If the oil sump capacity is greater than the oil sump capacity that is listed in Table 1, the oil change interval can be extended 1600 kilometers (1000 miles) for every 2 L (2 qt) increase in sump capacity.
- 2) API CH-4 and CI-4 oils are acceptable if the requirements of Caterpillar's ECF-1 (Engine Crankcase Fluid specification-1) are met. CH-4 and CI-4 oils that have not met the requirements of Caterpillar's ECF-1 Specification may cause reduced engine life.

Table 2

<b>Maximum Permissible Oil Change Intervals for On-Highway C11 and C13 Engines with Deep Sumps (Standard)</b>			
	<b>Severe Duty</b>	<b>Normal Duty</b>	<b>Light Duty</b>
<b>Fuel Consumption Kilometers Per Liter (Miles Per Gallon)</b>	Less than 2.6 km/L (6 MPG)	2.6 km/L (6 MPG) to 3 km/L (7 MPG)	Greater than 3 km/L (7 MPG)
<b>Gross Vehicle Weight</b>	More than 80,000 lb	80,000 lb or less	80,000 lb or less
<b>Minimum Oil Sump Capacity<sup>(1)</sup></b>	40 L (42 qt)	40 L (42 qt)	40 L (42 qt)
<b>Idle Time</b>	More than 40%	20% to 40%	Less than 20%
<b>Oil Classification</b>	API CH-4 or API CI-4 <sup>(2)</sup>		
<b>Kilometers (Miles)</b>	32,200 kilometers (20,000 miles)	48,300 kilometers (30,000 miles)	64,350 kilometers (40,000 miles)

- 1) If the oil sump capacity is greater than the oil sump capacity that is listed in Table 2, the oil change interval can be extended 1600 kilometers (1000 miles) for every 2 L (2 qt) increase in sump capacity.
- 2) API CH-4 and CI-4 oils are acceptable if the requirements of Caterpillar's ECF-1 (Engine Crankcase Fluid specification-1) are met. CH-4 and CI-4 oils that have not met the requirements of Caterpillar's ECF-1 Specification may cause reduced engine life.

## 5-3.35 Engine Valve Lash - Inspect/Adjust

The initial valve lash adjustment on new engines, rebuilt engines, or remanufactured engines is recommended at the first scheduled oil change. The adjustment is necessary due to the initial wear of the valve train components and to the seating of the valve train components.

This maintenance is recommended by Caterpillar as part of a lubrication and preventive maintenance schedule in order to help provide maximum engine life.



**NOTICE:** Only qualified service personnel should perform this maintenance. Consult your Caterpillar dealer for the complete valve lash adjustment procedure.

Operation of Caterpillar engines with improper valve adjustments can reduce engine efficiency. This reduced efficiency could result in excessive fuel usage and/or shortened engine component life.

### WARNING!!

**Ensure that the engine cannot be started while this maintenance is being performed. To help prevent possible injury, do not use the starting motor to turn the flywheel.**

**Hot engine components can cause burns. Allow additional time for the engine to cool before measuring/adjusting valve lash clearance.**

Ensure that the engine is stopped before measuring the valve lash. To obtain an accurate measurement, allow the valves to cool before this maintenance is performed.

The following components should be inspected and adjusted when the valves are inspected and adjusted.

- Valve Actuators
- Injectors
- Compression Brakes

## 5-3.36 Fan Drive Bearing - Lubricate



**NOTE:** In some applications, the fan drives are supplied by the OEM. Refer to the OEM specifications if the fan drive is not supplied by Caterpillar.

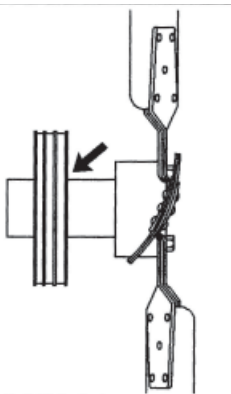

Lubricate the grease fitting that is on the fan drive bearing with Bearing Lubricant or the equivalent.

Inspect the fan drive pulley assembly for wear or for damage. If the shaft is loose, an inspection of the internal components should be performed.

## 5-3.37 Fuel System - Prime

### 5-3.37.1 C11 and C13 On-highway Engines

#### The Secondary Fuel Filter Has Been Replaced

#### WARNING!!

Fuel leaked or spilled onto hot surfaces or electrical components can cause a fire. To help prevent possible injury, turn the start switch off when changing fuel filters or water separator elements. Clean up fuel spills immediately.



**NOTICE:** Use a suitable container to catch any fuel that might spill. Clean up any spilled fuel immediately.



**NOTICE:** Do not allow dirt to enter the fuel system. Thoroughly clean the area around a fuel system component that will be disconnected. Fit a suitable cover over disconnected fuel system component.



**NOTE:** Refer to “*Fuel System Secondary Filter - Replace*” section for more information on replacing the filter.

1. Turn the ignition switch to the “OFF” position.



**NOTICE:** Do not crank the engine continuously for more than 30 seconds. Allow the starting motor to cool for two minutes before cranking the engine again.

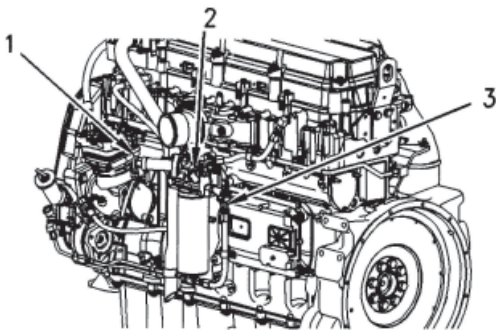

(1) Fuel Priming Pump,  
(2) Air Purge Screw, (3) Priming Valve (if equipped)

2. Start the engine. Operate the engine at 1000 to 1200 rpm until the engine runs smoothly in order to remove the residual air from the fuel system.
3. Once the engine runs smoothly, stop the engine. Turn the ignition switch to the OFF position.



**NOTE:** You may use the hand priming pump for the fuel filter (if equipped) instead of starting the engine and running the engine. Perform the following procedure when the hand priming pump is used:

- a. Turn the priming valve (3) (if equipped) to the “Closed (Prime)” position in order to prime the fuel system.
- b. Open the air purge screw (2) for the fuel filter by three full turns. Do not remove the air purge screw.
- c. While you operate the hand priming pump (1), observe air purge screw (2). When a small drop of fuel appears at the threads of the air purge screw, close and tighten air purge screw (2).



**NOTE:** Failure to tighten all fittings could result in serious fuel leaks.

- d. Clean any residual fuel from the engine components.
- e. Continue to operate the fuel priming pump (1) until a strong resistance is felt. Listen for an audible click from the fuel manifold. The click will indicate that the valve has opened and the fuel system is pressurized. Lock the fuel priming pump (1).

 **NOTICE:** Do not crank the engine continuously for more than 30 seconds. Allow the starting motor to cool for two minutes before cranking the engine again.

- f. Crank the engine. If the engine starts but the engine runs rough, continue to operate the engine at low idle until the engine runs smoothly.

 **NOTE:** If the engine will not start, further priming is necessary. If the engine starts but the engine continues to misfire or smoke, further priming is necessary.

- g. After the engine has operated smoothly for 30 seconds, turn the priming valve (3) to the “Open (Run)” position.

 **NOTE:** Shortened injector life may occur if the priming valve (3) is left in the “Closed (Prime)” position.

### 5-3.37.2 The Engine Has Been Run Out of Fuel

 **NOTICE:** Use a suitable container to catch any fuel that might spill. Clean up any spilled fuel immediately.

 **NOTICE:** Do not allow dirt to enter the fuel system. Thoroughly clean the area around a fuel system component that will be disconnected. Fit a suitable cover over disconnected fuel system component.

1. Turn the ignition switch to the “OFF” position.
2. Fill the fuel tank(s) with clean diesel fuel.
3. Turn the priming valve (3) (if equipped) to the “Closed (Prime)” position in order to prime the fuel system.
4. Open air purge screw (2) for the fuel filter by three full turns. Do not remove the air purge screw.

 **NOTICE:** Do not crank the engine continuously for more than 30 seconds. Allow the starting motor to cool for two minutes before cranking the engine again.

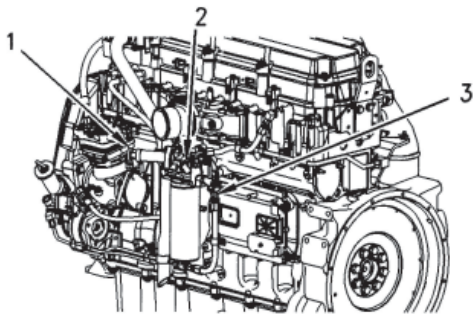

(1) Fuel Priming Pump,  
 (2) Air Purge Screw, (3) Priming Valve (if equipped)

5. Crank the engine for 30 seconds. Use a suitable container to catch the fuel while you crank the engine. Allow the starter motor to cool for 2 minutes.



**NOTE:** Most of the air should be purged from the system after four or five cranking cycles.

6. Crank the engine for 30 seconds. Allow the starter motor to cool for 2 minutes.
7. Repeat Step 6 until the engine starts and runs. If the engine runs rough, continue to operate the engine at low idle until the engine runs smoothly.

8. Observe air purge screw (2). When a small drop of fuel appears at the threads of the air purge screw, close and tighten air purge screw (2).



**NOTE:** Failure to tighten all fittings could result in serious fuel leaks.

9. After the engine has operated smoothly for 30 seconds, turn the priming valve (3) to the "Open (Run)" position.



**NOTE:** Shortened injector life may occur if the priming valve (3) is left in the "Closed (Prime)" position.

10. Clean any residual fuel from the engine components.

11. Once the engine runs smoothly, stop the engine. Turn the ignition switch to the "OFF" position.



**NOTE:** You may use the hand priming pump for the fuel filter (if equipped) instead of starting the engine and running the engine. Perform the following procedure when the hand priming pump is used:

- a. Turn the priming valve (3) (if equipped) to the "Closed (Prime)" position in order to prime the fuel system.
- b. Open air purge screw (2) for the fuel filter by three full turns. Do not remove the air purge screw.
- c. While you operate the hand priming pump (1), observe air purge screw (2). When a small drop of fuel appears at the threads of the air purge screw, close and tighten air purge screw (2).



**NOTE:** NOTE: Failure to tighten all fittings could result in serious fuel leaks.

- d. Clean any residual fuel from the engine components.
- e. Continue to operate the fuel priming pump (1) until a strong resistance is felt. Listen for an audible click from the fuel manifold. The click will indicate that the valve has opened and the fuel system is pressurized. Lock the fuel priming pump (1).

**NOTICE:** Do not crank the engine continuously for more than 30 seconds. Allow the starting motor to cool for two minutes before cranking the engine again.

- f. Crank the engine. If the engine starts but the engine runs rough, continue to operate the engine at low idle until the engine runs smoothly.

**NOTE:** If the engine will not start, further priming is necessary. If the engine starts but the engine continues to misfire or smoke, further priming is necessary.

- g. After the engine has operated smoothly for 30 seconds, turn the priming valve (3) to the “Open (Run)” position.

**NOTICE:** Shortened injector life may occur if the priming valve (3) is left in the “Closed (Prime)” position.

## 5-3.38 Fuel System Primary Filter - Clean/Replace

**WARNING!!** Fuel leaked or spilled onto hot surfaces or electrical components can cause a fire. To help prevent possible injury, turn the start switch off when changing fuel filters or water separator elements. Clean up fuel spills immediately.

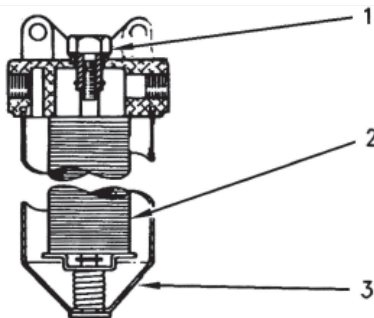

(1) Bolt, (2) Element, (3) Case

1. Stop the engine.
2. Turn the start switch to the “OFF” position. Disconnect the battery.
3. Shut off the fuel tank supply valve to the engine.
4. If the primary fuel filter is equipped with a drain valve, open the drain valve in order to drain any fuel from the filter case. Close the drain valve.

**NOTICE:** Use a suitable container to catch any fuel that might spill. Clean up any spilled fuel immediately.

5. Loosen the bolt (1) that is on the filter housing. Remove the filter case (3).
6. Remove the element (2) and wash the element in clean, nonflammable solvent.

**NOTICE:** Do not fill the fuel filters with fuel before installing them. The fuel would not be filtered and could be contaminated. Contaminated fuel will cause accelerated wear to fuel system parts.

7. Install the element (2) and the filter case (3). Tighten the bolt (1) to a torque of  $24 \pm 4 \text{ N} \cdot \text{m}$  ( $18 \pm 3 \text{ lb ft}$ ).



## 5-3.39 Fuel System Primary Filter/Water Separator - Drain

### WARNING!!

Fuel leaked or spilled onto hot surfaces or electrical components can cause a fire. To help prevent possible injury, turn the start switch off when changing fuel filters or water separator elements. Clean up fuel spills immediately.

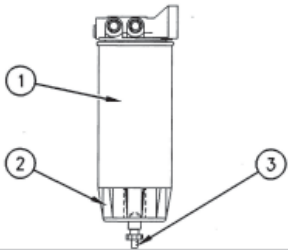

(1) Element, (2) Bowl, (3) Drain



**NOTICE:** Use a suitable container to catch any fuel that might spill. Clean up any spilled fuel immediately.



**NOTICE:** Do not fill the fuel filters with fuel before installing them. The fuel would not be filtered and could be contaminated. Contaminated fuel will cause accelerated wear to fuel system parts.

Bowl (2) should be monitored daily for signs of water. If water is present, drain the water from the bowl.

1. Open drain (3). The drain is a self-ventilated drain. Catch the draining water in a suitable container. Dispose of the water properly.
2. Close drain (3).



**NOTICE:** The water separator is under suction during normal engine operation. Ensure that the drain valve is tightened securely to help prevent air from entering the fuel system.

## 5-3.40 Fuel System Secondary Filter - Replace

### WARNING!!

Fuel leaked or spilled onto hot surfaces or electrical components can cause a fire. To help prevent possible injury, turn the start switch off when changing fuel filters or water separator elements. Clean up fuel spills immediately.



**NOTICE:** Do not allow dirt to enter the fuel system. Thoroughly clean the area around a fuel system component that will be disconnected. Fit a suitable cover over any disconnected fuel system components.



**NOTICE:** Use a suitable container to catch any fuel that might spill. Clean up any spilled fuel immediately.

1. Stop the engine. Turn the ignition switch to the OFF position or disconnect the battery. Refer to "[Battery or Battery Cable - Disconnect](#)" section of this manual for more information. Shut off the fuel supply valve (if equipped).
2. Remove the used fuel filter and discard the used fuel filter.
3. Clean the gasket sealing surface of the fuel filter base. Ensure that all of the old gasket is removed.
4. Apply clean diesel fuel to the new fuel filter gasket.



**NOTICE:** Do not fill the secondary fuel filter with fuel before installing. The fuel would not be filtered and could be contaminated. Contaminated fuel will cause accelerated wear to fuel system parts.



**NOTICE:** In order to maximize fuel system life and prevent premature wear out from abrasive particles in the fuel, a two micron absolute high efficiency fuel filter is required for all Caterpillar Hydraulic Electronic Unit Injectors. Caterpillar High Efficiency Fuel Filters meet these requirements. Consult your Caterpillar dealer for the proper part numbers.

- Install the new fuel filter. Spin the fuel filter onto the fuel filter base until the gasket contacts the base. Use the rotation index marks on the filters as a guide for proper tightening. Tighten the filter for an additional one turn (360 degrees) by hand. Do not overtighten the filter.
- Open the fuel supply valve. Prime the fuel system. Refer to "[Fuel System - Prime](#)" section in this manual for more information. Start the engine and inspect the fuel system for leaks.



**NOTICE:** Do not crank the engine continuously for more than 30 seconds. Allow the starting motor to cool for two minutes before cranking the engine again.



**NOTE:** There should be enough residual fuel in the cylinder head in order to start the engine. If the engine stops after starting, do not crank the engine for more than 30 seconds. Then allow the starting motor to cool for two minutes. Repeat this procedure until the engine starts and the engine operates.

## 5-3.41 Fuel System Water Separator - Drain

### WARNING!!

**Fuel leaked or spilled onto hot surfaces or electrical components can cause a fire. To help prevent possible injury, turn the start switch off when changing fuel filters or water separator elements. Clean up fuel spills immediately.**



**NOTICE:** The water separator is not a filter. It separates water from the fuel.

The engine should never be allowed to run with the water level in the separator more than ½ full or engine damage may result.

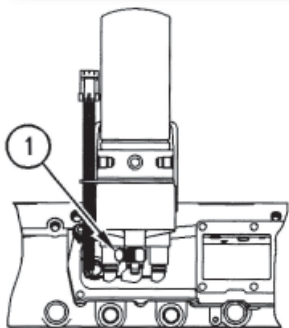

(1) Drain

A water separator is recommended. The water separator should be installed between the fuel tank and the engine fuel inlet. Drain the water and sediment from the water separator on a daily basis.

- Open drain (1). Catch the draining water in a suitable container. Dispose of the water properly.



**NOTICE:** The water separator is under suction during normal engine operation. Ensure that the drain valve is tightened securely to help prevent air from entering the fuel system.

- Close drain (1).

## 5-3.42 Fuel Tank Water and Sediment - Drain



**NOTICE:** Care must be taken to ensure that fluids are contained during performance of inspection, maintenance, testing, adjusting and repair of the product. Be prepared to collect the fluid with suitable containers before opening any compartment or disassembling any component containing fluids.

Dispose of all fluids according to local regulations and mandates.

### 5-3.42.1 Fuel Tank

Fuel quality is critical to the performance and to the service life of the engine. Water in the fuel can cause excessive wear to the fuel system. Condensation occurs during the heating and cooling of fuel. The condensation occurs as the fuel passes through the fuel system and the fuel returns to the fuel tank. This causes water to accumulate in fuel tanks. Draining the fuel tank regularly and obtaining fuel from reliable sources can help to eliminate water in the fuel.

### 5-3.42.2 Drain the Water and the Sediment

Fuel tanks should contain some provision for draining water and draining sediment from the bottom of the fuel tanks.

Open the drain valve on the bottom of the fuel tank in order to drain the water and the sediment. Close the drain valve.

Check the fuel daily. Drain the water and sediment from the fuel tank after operating the engine or drain the water and sediment from the fuel tank after the fuel tank has been filled. Allow five to ten minutes before performing this procedure.

Fill the fuel tank after operating the engine in order to drive out moist air. This will help prevent condensation. Do not fill the tank to the top. The fuel expands as the fuel gets warm. The tank may overflow.

Some fuel tanks use supply pipes that allow water and sediment to settle below the end of the fuel supply pipe. Some fuel tanks use supply lines that take fuel directly from the bottom of the tank. If the engine is equipped with this system, regular maintenance of the fuel system filter is important.

### 5-3.42.3 Fuel Storage Tanks

Drain the water and the sediment from the fuel storage tank during the following conditions:

- Weekly
- Oil Change
- Refill of the Tank

This will help prevent water or sediment from being pumped from the storage tank into the engine fuel tank.

If a bulk storage tank has been refilled or moved recently, allow adequate time for the sediment to settle before filling the engine fuel tank. Internal baffles in the bulk storage tank will also help trap sediment. Filtering fuel that is pumped from the storage tank helps to ensure the quality of the fuel. When possible, water separators should be used.

## 5-3.43 Hoses and Clamps - Inspect/Replace

Inspect all hoses for leaks that are caused by the following conditions:

- Cracking
- Softness
- Loose Clamps



**NOTICE:** Do not bend or strike high pressure lines. Do not install bent or damaged lines, tubes or hoses. Repair any loose or damaged fuel and oil lines, tubes and hoses. Leaks can cause fires. Inspect all lines, tubes and hoses carefully. Tighten all connections to the recommended torque.

Check the following conditions:

- End fittings that are damaged or leaking
- Outer covering that is chafed or cut
- Exposed wire that is used for reinforcement
- Outer covering that is ballooning locally
- Flexible part of the hose that is kinked or crushed
- Armoring that is embedded in the outer covering

A constant torque hose clamp can be used in place of any standard hose clamp. Ensure that the constant torque hose clamp is the same size as the standard clamp.

Due to extreme temperature changes, the hose will heat set. Heat setting causes hose clamps to loosen. This can result in leaks. A constant torque hose clamp will help to prevent loose hose clamps.

Each installation application can be different. The difference depends on the following factors:

- Type of hose
- Type of fitting material
- Anticipated expansion and contraction of the hose
- Anticipated expansion and contraction of the fittings

### 5-3.41.1 Replace the Hoses and the Clamps

**WARNING!!**

**Pressurized System - Hot coolant can cause serious burns. To open the cooling system filler cap, stop the engine and wait until the cooling system components are cool. Loosen the cooling system pressure cap slowly in order to relieve the pressure.**

1. Stop the engine. Allow the engine to cool.
2. Loosen the cooling system filler cap slowly in order to relieve any pressure. Remove the cooling system filler cap.



**NOTE:** Drain the coolant into a suitable, clean container. The coolant can be reused.

3. Drain the coolant from the cooling system to a level that is below the hose that is being replaced.
4. Remove the hose clamps.
5. Disconnect the old hose.
6. Replace the old hose with a new hose.



**NOTE:** Refer to the Specifications, SENR3130 in order to locate the proper torques.

7. Install the hose clamps with a torque wrench.



**NOTE:** For the proper coolant to use, see “[Coolant Recommendations](#)” section of this manual.

8. Refill the cooling system.
9. Clean the cooling system filler cap. Inspect the cooling system filler cap's gaskets. Replace the cooling system filler cap if the gaskets are damaged. Install the cooling system filler cap.
10. Start the engine. Inspect the cooling system for leaks.

### 5-3.44 Radiator - Clean



**NOTE:** Adjust the frequency of cleaning according to the effects of the operating environment.

Inspect the radiator for these items: damaged fins, corrosion, dirt, grease, insects, leaves, oil, and other debris. Clean the radiator, if necessary.

**WARNING!!**

**Personal injury can result from air pressure.**

**Personal injury can result without following proper procedure. When using pressure air, wear a protective face shield and protective clothing.**

**Maximum air pressure at the nozzle must be less than 205 kPa (30 psi) for cleaning purposes.**

Pressurized air is the preferred method for removing loose debris. Direct the air in the opposite direction of the fan's air flow. Hold the nozzle approximately 6 mm (0.25 inch) away from the fins. Slowly move the air nozzle in a direction that is parallel with the tubes. This will remove debris that is between the tubes.

Pressurized water may also be used for cleaning. The maximum water pressure for cleaning purposes must be less than 275 kPa (40 psi). Use pressurized water in order to soften mud. Clean the core from both sides.

Use a degreaser and steam for removal of oil and grease. Clean both sides of the core. Wash the core with detergent and hot water. Thoroughly rinse the core with clean water.

After cleaning, start the engine and accelerate the engine to high idle rpm. This will help in the removal of debris and drying of the core. Stop the engine. Use a light bulb behind the core in order to inspect the core for cleanliness. Repeat the cleaning, if necessary.

Inspect the fins for damage. Bent fins may be opened with a “comb”. Inspect these items for good condition: welds, mounting brackets, air lines, connections, clamps, and seals. Make repairs, if necessary.

## 5-3.45 Severe Service Application - Check

Operation and maintenance practices affect the service life of the components when the engine is operated in severe service applications.

The level of maintenance is crucial to the service life of the engine. Other major factors that affect service life are operating speed and loads.

The conditions that follow can indicate severe service operations:

- Operation above 36,320 kg (80,000 lb) gross vehicle weight (GVW) and other high load factor operations (such as off-highway)
- Frequent high altitude operation above 1525 m (5000 ft)
- Extended operation at low idle
- Arctic operation (regular cold starts at temperatures below -18°C (0°F))
- Extending maintenance beyond the recommended maintenance intervals
- Frequent hot shutdowns (minimum five minute cool down periods after high load factor operation)
- Use of fuels that are NOT recommended by Caterpillar in the Fuel Specifications
- Extreme ambient temperature conditions that may cause the lubricating properties of the fuel to diminish
- Frequent plugging of the fuel filter
- Extended maintenance intervals of the fuel system
- Inadequate maintenance of fuel storage tanks (excessive water, sediment, microorganism growth, etc.)

## 5-3.46 Turbocharger - Inspect

Periodic inspection and cleaning is recommended for the turbocharger compressor housing (inlet side)

If the turbocharger fails during engine operation, damage to the turbocharger compressor wheel and/or to the engine may occur. Damage to the turbocharger compressor wheel can cause additional damage to the pistons, the valves, and the cylinder head.



**NOTICE:** Turbocharger bearing failures can cause large quantities of oil to enter the air inlet and exhaust systems. Loss of engine lubricant can result in serious engine damage.

Minor leakage of a turbocharger housing under extended low idle operation should not cause problems as long as a turbocharger bearing failure has not occurred.

When a turbocharger bearing failure is accompanied by a significant engine performance loss (exhaust smoke or engine rpm up at no load), do not continue engine operation until the turbocharger is repaired or replaced.

A periodic inspection of the turbocharger can minimize unscheduled downtime and the chance for potential damage to other engine parts.



**NOTE:** Turbocharger components require precision clearances with proper balancing in order to support high operating speeds. Severe Service Applications can accelerate component wear. Therefore, more frequent inspections of the cartridge are required.

### 5-3.46.1 Removal and Installation

For options regarding the inspection, removal, installation, repair and replacement, consult your authorized Caterpillar service center.

## 5-3.47 Valve Actuators - Inspect/Adjust

The valve actuators should be inspected and adjusted when adjustments to the following components occur.

- Valves
- Injectors
- Compression Brakes

Refer to the System Operation, Test and Adjust Manual for the proper adjustment procedure.

## 5-3.48 Walk-Around Inspection

### 5-3.48.1 Inspect the Engine for Leaks and for Loose Connections

A walk-around inspection should only take a few minutes. When the time is taken to perform these checks, costly repairs and accidents can be avoided.

For maximum engine service life, make a thorough inspection of the engine compartment before starting the engine. Look for items such as oil leaks or coolant leaks, loose bolts, worn belts, loose connections and trash buildup. Make repairs, as needed:

- The guards must be in the proper place. Repair damaged guards or replace missing guards.
- Wipe all caps and plugs before the engine is serviced in order to reduce the chance of system contamination.



**NOTICE:** For any type of leak (coolant, lube, or fuel) clean up the fluid. If leaking is observed, find the source and correct the leak. If leaking is suspected, check the fluid levels more often than recommended until the leak is found or fixed, or until the suspicion of a leak is proved to be unwarranted.



**NOTICE:** Accumulated grease and/or oil on an engine or deck is a fire hazard. Remove the debris with steam cleaning or high pressure water.

- Ensure that the cooling lines are properly clamped and that the cooling lines are tight. Check for leaks. Check the condition of all pipes.
- Inspect the water pumps for coolant leaks.



**NOTE:** The water pump seal is lubricated by coolant in the cooling system. It is normal for a small amount of leakage to occur as the engine cools down and the parts contract.

Excessive coolant leakage may indicate the need to replace the water pump seal. For the removal of water pumps and the installation of water pumps and/or seals, refer to your servicing dealer.

- Inspect the lubrication system for leaks at the front crankshaft seal, the rear crankshaft seal, the oil pan, the oil filters and the valve cover.
- Inspect the fuel system for leaks. Look for loose fuel line clamps or for loose fuel line tie-wraps.
- Inspect the piping for the air inlet system and the elbows for cracks and for loose clamps. Ensure that hoses and tubes are not contacting other hoses, tubes, wiring harnesses, etc.
- Inspect the alternator belt and the accessory drive belts for cracks, breaks or other damage.

Belts for multiple groove pulleys must be replaced as matched sets. If only one belt is replaced, the belt will carry more load than the belts that are not replaced. The older belts are stretched. The additional load on the new belt could cause the belt to break.

- Drain the water and the sediment from fuel tanks on a daily basis in order to ensure that only clean fuel enters the fuel system.
- Inspect the wiring and the wiring harnesses for loose connections and for worn wires or frayed wires.
- Inspect the ground strap for a good connection and for good condition.
- Inspect the ECM to the cylinder head ground strap for a good connection and for good condition.
- Disconnect any battery chargers that are not protected against the current drain of the starting motor. Check the condition and the electrolyte level of the batteries, unless the engine is equipped with a maintenance free battery.
- Check the condition of the gauges. Replace any gauges that are cracked. Replace any gauge that can not be calibrated.

## 5-3.49 Lubrication Points

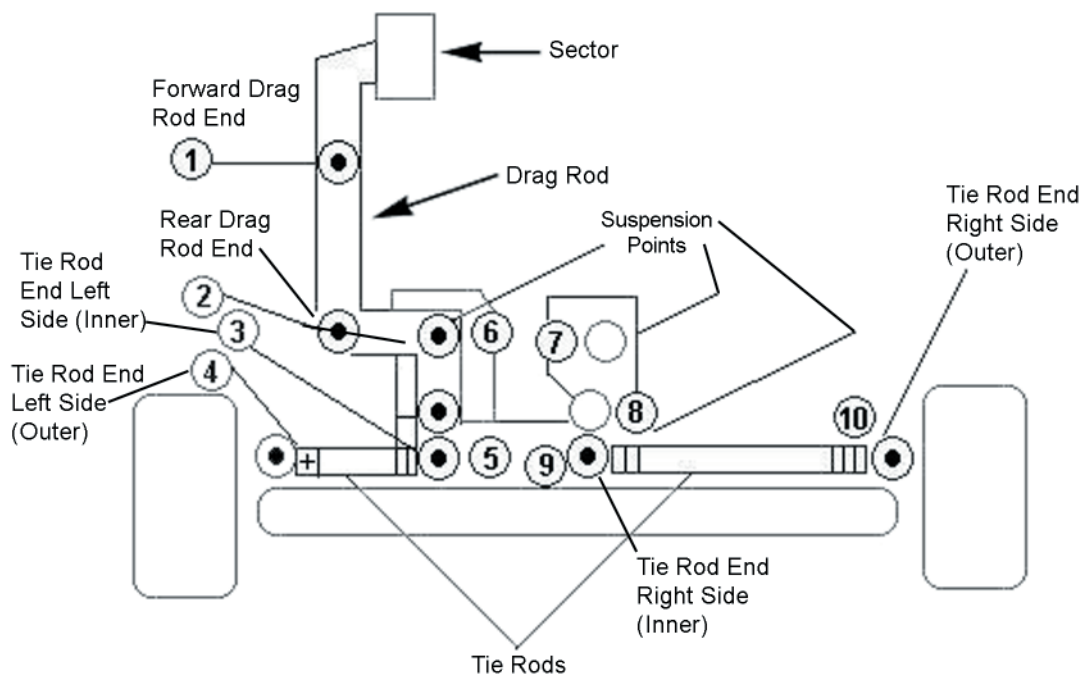

**NOTE:** There are also two universal joints on drive shaft to include in Lubrication Points.

## 5-3.50 Customer Service

### 5-3.50.1 Customer Assistance

#### USA and Canada

When a problem arises concerning the operation of an engine or concerning the service of an engine, the problem will normally be managed by the dealer in your area.

Your satisfaction is a primary concern to Caterpillar and to Coachworks. To get in touch with the Caterpillar Field Service Coordinator: 1-800-447-4986 or submit problem in writing to:

**Caterpillar Inc.**

Manager, Customer Service, Engine Division

Mossville Bldg AC

P.O. Box 610

Mossville, Illinois 61552-0610



## 5-4 PowerTech PTSMH20.0 Generator Maintenance/Service

### 5-4.1 Maintenance

#### CAUTION!!

To avoid personal injury:

- Be sure to conduct daily checks, periodic maintenance, refueling or cleaning on a level surface with the engine shut off and key removed.
- Before allowing other people to use the engine, explain how to operate, and have them read this manual before operation.
- When cleaning any parts, do not use gasoline but use regular cleanser.
- Always use proper tools, that are in good condition. Make sure you understand how to use them, before performing any service work.
- When installing, be sure to tighten all bolts to specified torque.
- Do not put any tools on the battery, or battery terminals may short out. Severe burns or fire could result. Detach the battery from the engine before maintenance.
- Do not touch muffler or exhaust pipes while they are hot; severe burns could result.

### 5-4.3 Service Intervals

Observe the following for service and maintenance.

The lubricating oil change intervals listed in the table below are for Classes CF, CE and CD lubricating oils of API classification with a low-sulfur fuel in use. If the CF-4 or CG-4 lubricating oil is used with a high-sulfur fuel, change the lubricating oil at shorter intervals than recommended in the table below depending on the operating condition.

No.	Check Point	Interval										
		First 50 Hours	Every 50 Hours	Every 100 Hours	Every 200 Hours	Every 400 Hours	Every 500 Hours	Every 800 Hours	Every 1500 Hours	Every 3000 Hours	Every 1 Year	Every 2 Years
1	Check of fuel pipes and clamp bands		○									
2	Change of engine oil	⊖			○							
3	Cleaning of air cleaner element			○								
4	Check of battery electrolyte level			○								
5	Check of fan belt tightness			○								
6	Check of radiator hoses and clamp bands				○							
7	Check of intake air line				○							
8	Replacement of oil filter cartridge	⊖				○						
9	Replacement of fuel filter cartridge					○						
10	Removal of sediment in fuel tank						○					
11	Cleaning of water jacket (radiator interior)						○					
12	Replacement of fan belt						○					
13	Check of valve clearance							○				
14	Replacement of air cleaner element										○	
15	Check of damage in electric wiring and loose connections										○	
16	Check of fuel injection nozzle injection pressure								○			
17	Check of turbo charger									○		
18	Check of injection pump									○		
19	Check of fuel injection timer									○		
20	Replacement of fuel pipes and clamp bands											○

**Service Intervals - continued**

No.	Check Point	Interval											
		First 50 Hours	Every 50 Hours	Every 100 Hours	Every 200 Hours	Every 400 Hours	Every 500 Hours	Every 800 Hours	Every 1500 Hours	Every 3000 Hours	Every 1 Year	Every 2 Years	
21	Replacement of radiator hoses and clamp bands												○
22	Replacement of battery												○
23	Change of radiator coolant (L.L.C.)												○
24	Replacement of intake air line												○

**IMPORTANT**

- The jobs indicated by Θ must be done after the first 50 hours of operation.
- \*1 Air cleaner should be cleaned more often in dusty conditions than in normal conditions.
- \*2 After 6 times of cleaning.
- \*3 Consult your local KUBOTA Dealer for this service.
- \*4 Replace only if necessary.
- The items listed above (@ marked) are registered as emission related critical parts by KUBOTA in the U.S. EPA nonroad emission regulation. As the engine owner, you are responsible for the performance of the required maintenance on the engine according to the above instruction.



**NOTE: Lubricating Oil** - With the emission control now in effect, the CF-4 and CG-4 lubricating oils have been developed for use of a low-sulfur fuel on on-road vehicle engines. When an off-road vehicle engine runs on a high-sulfur fuel, it is advisable to employ the CF, CD or CE lubricating oil with a high total base number. If the CF-4 or CG-4 lubricating oil is used with a high-sulfur fuel, change the lubricating oil at shorter intervals.

**Lubricating Oil Recommended when a low-sulfur or high-sulfur fuel is employed.**

O: Recommended X: Not Recommended

Lubricating Oil Class	Fuel	Low-sulfur	High-sulfur	Remarks
	CF		O	O
CF-4		O	X	
CG-4		O	X	

**5-4.4 Periodic Service****5-4.4.1 Fuel**

Fuel is flammable and can be dangerous. Be sure to handle with care.

**CAUTION!!**

To avoid personal injury:

- Do not mix gasoline or alcohol with diesel fuel. This mixture can cause an explosion.
- Be careful not to spill fuel during refueling. If fuel should spill, wipe it off at once, or it may cause a fire.
- Do not fail to stop the engine before refueling. Keep the engine away from the fire.
- Be sure to stop the engine while refueling or bleeding and when cleaning or changing fuel filter or fuel pipes. Do not smoke when working around the battery or when refueling.
- Check the above fuel systems in a well ventilated and wide open place.
- When fuel and lubricant are spilled, refuel after letting the engine cool off.
- Always keep spilled fuel and lubricant away from engine.

**Fuel Level Check and Refueling**

1. Check to see that the fuel level is above the lower limit of the fuel level gauge.
2. If the fuel is too low, add fuel to the upper limit. Do not overfill.

No. 2-D is a distillate fuel oil of lower volatility for engines in industrial and heavy mobile service. (SAE J313 JUN87)

Grade of Diesel Fuel Oil According to ASTM D975

Flash Point, °C (°F)	Water and Sediment, volume %	Carbon Residue on 10 percent Residuum, %	Ash, weight %
Min	Max	Max	Max
52 (125)	0.05	0.35	0.01

Distillation Temperatures, °C (°F) 90% Point		Viscosity Kenematic cSt or mm <sup>2</sup> /s at 40°C		Viscosity Sayboit, SUS at 100°F		Sulfur weight %	Copper strip Corrosion	Cetane Number
Min	Max	Min	Max	Min	Max	Max	Max	Min
282 (540)	338 (640)	1.9	4.1	32.8	40.1	0.5	No. 3	40

The cetane number is required not to be less than 45

**!!!IMPORTANT:**

- Be sure to use a strainer when filling the fuel tank, or dirt or sand in the fuel may cause trouble in the fuel injection pump.
- For fuel, always use diesel fuel. Do not to use alternative fuel, its quality is unknown and it may be inferior in quality. Kerosene, which is very low in cetane rating, adversely affects the engine. Diesel fuel differs in grades depending on the temperature.
- Do not to let the fuel tank become empty, or air can enter the fuel system, necessitating bleeding before next engine start.

### 5-4.4.2 Air Bleeding the Fuel System

**CAUTION!!**

To avoid personal injury:

Do not bleed a hot engine, this could cause fuel to spill onto a hot exhaust manifold creating a danger of fire.

Air bleeding of the fuel system is required:

- After the fuel filter and pipes have been detached and refitted;
- After the fuel tank has become empty; or
- Before the engine is to be used after a long storage.

**PROCEDURE:**

1. Fill the fuel tank to the fullest extent. Open the fuel filter lever.
2. Open the air vent cock on top of the fuel injection pump.
3. Turn the engine, continue it for about 10 seconds, then stop it, or move the fuel feed pump lever by hand (optional).
4. Close the air vent cock on top of the fuel injection pump.

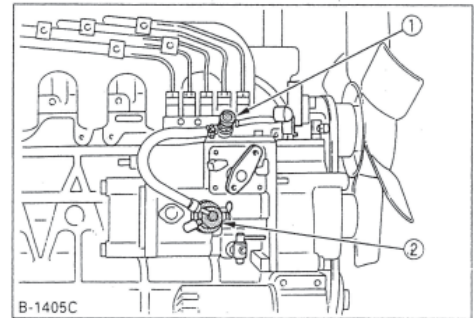

(1) Air vent cock  
(2) Fuel feed pump

**!!!IMPORTANT:** Always keep the air vent cock on the fuel injection pump closed except when air is vented, or it may cause the engine to stop.

### 5-4.4.3 Checking the Fuel Pipes

**CAUTION!!**

To avoid personal injury:

Check or replace the fuel pipes after stopping the engine. Broken fuel pipes can cause fires.

Check the fuel pipes every 50 hours of operation.

1. If the clamp band is loose, apply oil to the screw of the band, and tighten the band securely.
2. If the fuel pipes, made of rubber, become worn out, replace them and the clamp bands every two years.
3. If the fuel pipes and clamp bands are found worn or damaged before two years time, replace or repair them at once.
4. After replacement of the pipes and bands, air-bleed the fuel system.

**!!!IMPORTANT:** When the fuel pipes are not installed, plug them at both ends with clean cloth or paper to prevent dirt from entering. Dirt in the pipes can cause fuel injection pump malfunction.

### 5-4.4.4 Fuel Filter Cartridge Replacement

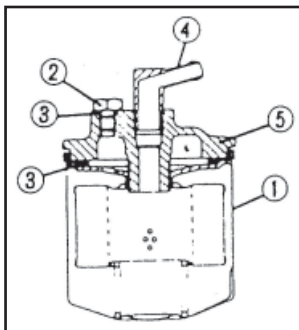

- (1) Fuel Filter Cartridge
- (2) Air Vent Plug
- (3) O Ring
- (4) Pipe Joint
- (5) Cover

1. Replace the fuel filter cartridge with a new one every 400 operating hours.
2. Apply fuel oil thinly over the gasket and tighten the cartridge into position by hand-tightening only.
3. Finally, vent the air.

**!!!IMPORTANT:** Replace the fuel filter cartridge periodically to prevent wear of the fuel injection pump plunger or the injection nozzle, due to dirt in the fuel.

## 5-4.5 Engine Oil

### CAUTION!!

To avoid personal injury:

- Be sure to stop the engine before checking and changing the engine oil and the oil filter cartridge.
- Do not touch muffler or exhaust pipes while they are hot; Severe burns could result. Always stop the engine and allow it to cool before conducting inspections, maintenance, or for a cleaning procedure.
- Contact with engine oil can damage your skin. Put on gloves when using engine oil, if you come in contact with engine oil, wash it off immediately.



**NOTE:** Be sure to inspect the engine, locating it on a level place. If placed on gradients accurate oil quantity may not be measured.

### 5-4.5.1 Checking Oil Level and Adding Engine Oil

1. Check the engine oil level before starting or more than 5 minutes after stopping the engine.
2. Remove the oil level gauge, wipe it clean and reinstall it.
3. Take the oil level gauge out again, and check the oil level.

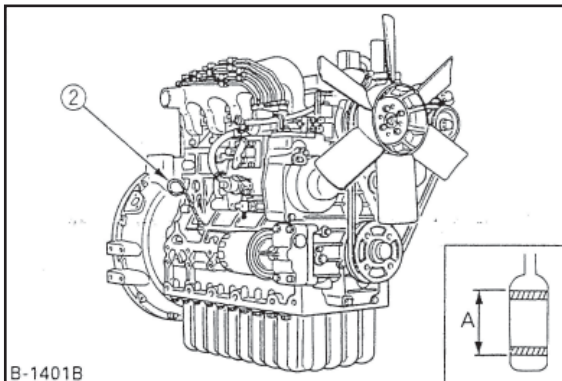

(1) Oil filler plug  
(2) Oil level gauge

[Lower end of oil level gauge]  
(A) Engine oil level within this range is proper.

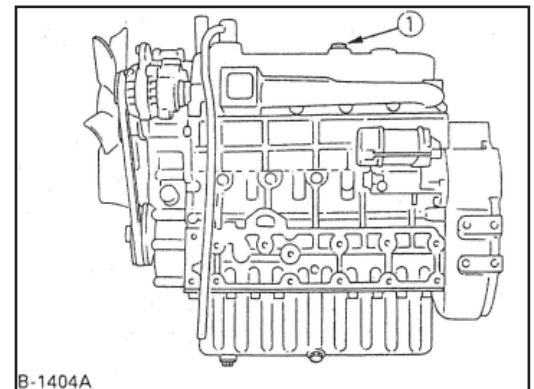

B-1404A

4. If the oil level is too low, remove the oil filter plug, and add new oil to the prescribed level.
5. After adding oil, wait more than 5 minutes and check the oil level again. It takes some time for the oil to drain down to the oil pan.
6. If the engine is operated with the oil level nearing the lower limit, oil may deteriorate quickly; keeping the oil level near the upper limit is recommended.

### Engine oil quantity

Models	Oil Pan Depth	
	124mm (4.88 in.)	≈90mm (3.54 in.)
D1403-BG	7.0L	5.6L
D1703-BG	(1.85 U.S. gals.)	(4.48 U.S. gals.)
V1903-BG	9.5L	7.6L
V2203-BG	(2.51 U.S. gals.)	(2.01 U.S. gals.)
F2803-BG	12.0L (3.17 U.S. gals.)	-

≈90mm (3.54 in.) oil pan depth is optional.  
Oil quantities shown are for standard oil pans.

**!!!IMPORTANT:** Engine oil should be MIL-L-2104C or have properties of API classification CD grades or higher. Change the type of engine oil according to the ambient temperature.

above 25°C (77°F)	SAE 30 or	SAE 10W-30 SAE 10W-40
0 to 25°C (32 to 77°F)	SAE 20 or	SAE 10W-30 SAE 10W-40
below 0°C (32°F)	SAE 10W or	SAE 10W-30 SAE 10W-40

When using oil of different brands from the previous one, be sure to drain all the previous oil before adding the new engine oil.

### 5-4.5.2 Changing Engine Oil

#### CAUTION!!

To avoid personal injury:

Be sure to stop the engine before draining engine oil.  
When draining engine oil, place a container underneath the engine and dispose of it according to local regulations.  
Do not drain oil after running the engine. Allow engine to cool down sufficiently.

1. Change oil after the initial 50 hours of operation and every 200 hours thereafter.
2. Remove the drain plug at the bottom of the engine, and drain all the old oil. Oil will drain easier when the oil is warm.
3. Add new engine oil up to the upper limit of the oil level gauge.

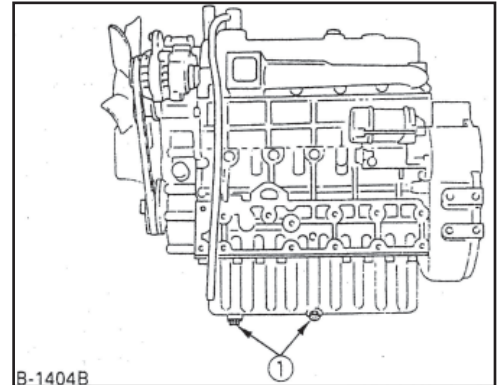

B-1404B

(1) Oil drain plug

### 5-4.5.3 Replacing the Oil Filter Cartridge

#### CAUTION!!

To avoid personal injury:

- Be sure to stop the engine before changing the oil filter cartridge.
- Allow engine to cool down sufficiently. Oil can be hot and cause burns.

1. Replace the oil filter cartridge after every 400 hours of operation.
2. Remove the old oil filter cartridge with a filter wrench.
3. Apply a film of oil to the gasket for the new cartridge.
4. Screw in the cartridge by hand. When the gasket contacts the seal surface, tighten the cartridge enough by hand. Because, if you tighten the cartridge with a wrench, it will be tightened too much.
5. After the new cartridge has been replaced, the engine oil level normally decreases a little. Run the engine for a while and check for oil leaks through the seal before checking the engine oil level. Add oil if necessary.

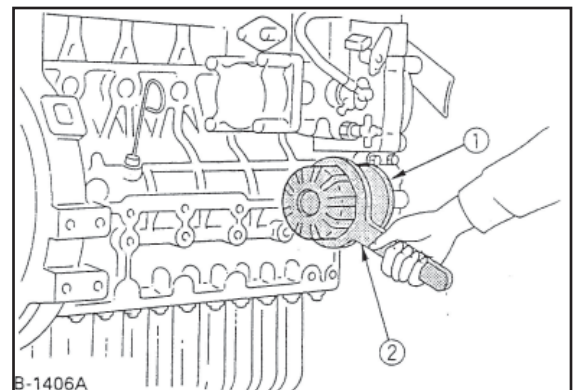

B-1406A

- (1) Oil filter cartridge  
(2) Remove with a filter wrench  
(Tighten with your hand)



**NOTE:** Wipe off any oil sticking to the machine completely.

### 5-4.6 Radiator

Coolant will last for one day's work if filled all the way up before operation. Be sure to check the coolant level before every operation.

#### WARNING!!

To avoid personal injury:

- Do not stop the engine suddenly. Stop it after about 5 minutes of unloaded idling.
- Work only after letting the engine and radiator cool off completely (more than 30 minutes after it has been stopped).
- Do not remove the radiator cap while coolant is hot. When cool to the touch, rotate cap to the first stop to allow excess pressure to escape. Then remove cap completely.

If overheats should occur, steam may gush out from the radiator or reserve tank; Severe burns could result.

### 5-4.6.1 Checking Coolant Level, Adding Coolant

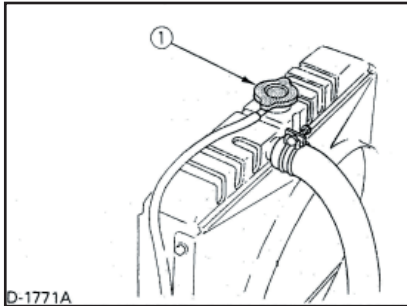

(1) Radiator pressure cap

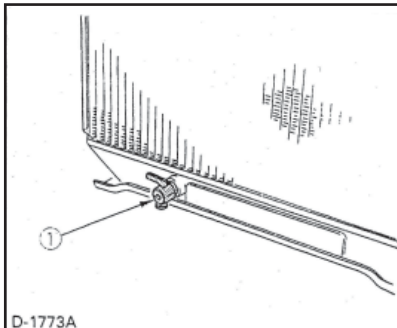

(1) Coolant drain cock

1. Remove the radiator cap after the engine has completely cooled, and check to see that coolant reaches the supply port.
2. If the radiator is provided with a reserve tank, check the coolant level of the reserve tank. When it is between the "FULL" and "LOW" marks, the coolant will last for one day's work.
3. When the coolant level drops due to evaporation, add water only up to the full level.
4. Check to see that two drain cocks; one is at the crankcase side and the other is at the lower part of the radiator as figures B-1405D and D-1773A show.

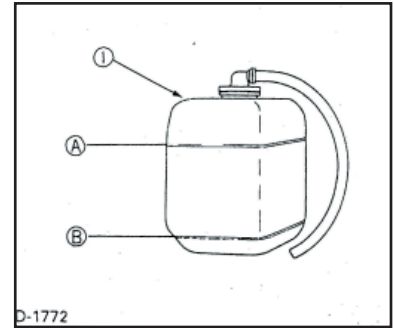

(1) Reserve tank (A) "FULL" (B) "LOW"

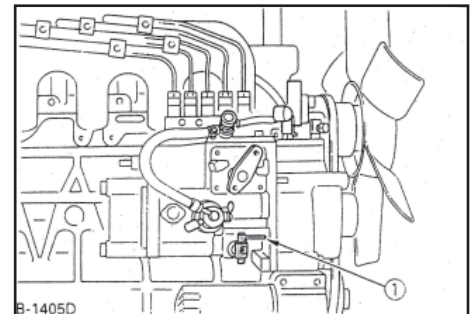

B-1405D

**!!IMPORTANT:**

- If the radiator cap has to be removed, follow the caution and securely retighten the cap.
- If coolant should leak, consult your local KUBOTA dealer.
- Make sure that muddy or sea water does not enter the radiator.
- Use clean, fresh water and 50% anti-freeze to fill the recovery tank.
- Do not refill reserve tank with coolant over the "FULL" level mark.
- Be sure to close the radiator cap securely. If the cap is loose or improperly closed, coolant may leak out and decrease quickly.
- When coolant is added, coolant level drops the first time the engine is started. Stop the engine, and add more coolant.

### 5-4.6.2 Changing Coolant

1. To drain coolant, always open both drain cocks and simultaneously open the radiator cap as well. With the radiator cap kept closed, a complete drain of water is impossible.
2. Remove the overflow pipe of the radiator pressure cap to drain the reserve tank.
3. Prescribed coolant volume (U.S. gallons)

Models	Quantity
D1403-BG	4.2L (1.11 US gals.)
D1703-BG	5.5L (1.45 US gals.)
V1903-BG	6.4L (1.69 US gals.)
V2203-BG	8.1L (2.14 US gals.)
F2803-BG	8.2L (2.17 US gals.)



**NOTE:** Coolant quantities shown are for standard radiators.

4. An improperly tightened radiator cap or a gap between the cap and the seat quickens loss of coolant.
5. Coolant (Radiator cleaner and anti-freeze)

Season	Coolant
Summer	Pure water and radiator cleaner
Winter (When temperature drops below 0°C (32°F) or all season	Pure water and anti-freeze (See "Anti-freeze" in RADIATOR section)

### 5-4.6.3 Remedies for Quick Decrease of Coolant

1. Check any dust and dirt between the radiator fins and tube. If any, remove them from the fins and the tube.
2. Check the tightness of the fan belt. If loose, tighten it securely.
3. Check the internal blockage in the radiator hose. If scale forms in the hose, clean with the scale inhibitor or its equivalent.

### 5-4.6.4 Checking Radiator Hoses and Clamp

#### CAUTION!!

To avoid personal injury:

Be sure to check radiator hoses and hose clamps periodically. If radiator hose is damaged or coolant leaks, overheats or severe burns could occur.

Check to see if radiator hoses are properly fixed every 200 hours of operation or 6 months, whichever comes first.

1. If hose clamps are loose or water leaks, tighten hose clamps securely.
  2. Replace hoses and tighten hose clamps securely, if radiator hoses are swollen, hardened or cracked.
- Replace hoses and hose clamps every 2 years, or earlier, if checked and found that hoses are swollen, hardened or cracked.

### 5-4.6.5 Precaution at Overheating

Take the following actions in the event the coolant temperature is nearly or more than the boiling point, what is called "Overheating". Take these actions if the engine's alarm buzzer sounds or the alarm lamp lights up.

1. Stop the engine operation in a safe place and keep the unloaded engine idling.
2. Do not stop the engine suddenly. Stop it after about 5 minutes of unloaded idling.
3. If the engine stalls within 5 minutes of running under no load, immediately leave and keep away from the machine. Do not open the hood or any other part.
4. Keep yourself and others well away from the engine for 10 minutes further or while the steam is blowing out.
5. Checking that there is no danger such as burns, eliminate the cause of overheating according to the manual, see "Troubleshooting" section. And then, start the engine again.

### 5-4.6.6 Cleaning Radiator Core (Outside)

If dust is between the fin and tube, wash it away with running water.

### 5-4.6.7 Cleaning the Radiator

Clean the cooling system of the engine every 500 hours. In addition, clean it before adding anti-freeze and before stopping use of anti-freeze.

**!!!IMPORTANT: Do not clean radiator with firm tools such as spatulas or screwdrivers. They may damage specified fin or tube, and can cause coolant leaks or decrease cooling performance.**

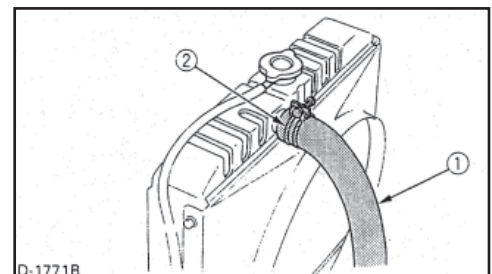

D-1771B

- (1) Radiator hose  
(2) Clamp band



### 5-4.6.8 Anti-freeze

#### CAUTION!!

To avoid personal injury:

- When using anti-freeze use protection such as rubber gloves.
- If you should drink anti-freeze, throw up at once and seek medical attention.
- When anti-freeze comes in contact with the skin or clothing, wash it off immediately.
- Do not mix different types of anti-freeze.
- Keep fire and children away from anti-freeze.
- Be mindful of the environment and ecology. Before draining any fluids, find out the correct way of disposing by checking with local codes.

Also, observe the relevant environmental protection regulations when disposing of oil, fuel, coolant, brake fluid, filters and batteries.

If coolant freezes, it can damage the cylinders and radiator. It is necessary, if the ambient temperature falls below 0 °C (32 °F), to remove coolant after operating or to add anti-freeze to coolant.

1. There are two types of anti-freeze available; use the permanent type (PT) for this engine.
2. Before adding anti-freeze for the first time, clean the radiator and engine interior by pouring fresh water, and draining it a few times.
3. The procedure for the mixing of water and anti-freeze can vary according to the type of anti-freeze being used and the ambient temperature. Refer to SAE J1034 standard, more specifically also to SAE J814c.
4. Mix the anti-freeze with water, and then pour into the radiator.

**!!IMPORTANT: When the anti-freeze is mixed with water, the antifreeze mixing ratio must be less than 50%.**

Vol % Anti-freeze	Freezing Point		Boiling Point <sup>Ⓜ</sup>	
	°C	°F	°C	°F
40	-24	-12	106	222
50	-37	-34	108	226

<sup>Ⓜ</sup>At 1.013 x 10<sup>5</sup>Pa (760mmHg) pressure (atmospheric). A higher boiling point is obtained by using a radiator pressure cap which permits the development of pressure within the cooling system.



#### NOTE:

- The above data represents industry standards that necessitate a minimum glycol content in the concentrated anti-freeze.
- When the coolant level drops due to evaporation, add water only to keep the anti-freeze mixing ratio less than 50%. In case of leakage, add anti-freeze and water in the specified mixing ratio before pouring into the radiator.
- Anti-freeze absorbs moisture. Keep unused anti-freeze in a tightly sealed container.
- Do not use radiator cleaning agents when anti-freeze has been added to the coolant. (Anti-freeze contains an anti-corrosive agent, which will react with the radiator cleaning agent forming sludge which will affect the engine parts.)

### 5-4.6.9 Radiator Cement

As the radiator is solidly constructed, there is little possibility of water leakage. Should this happen, however, radiator cement can easily fix it. If leakage is serious, contact your local KUBOTA dealer.

## 5-4.7 Air Cleaner

Since the air cleaner employed on this engine is a dry type, never apply oil to it.

1. Open the evacuator valve once a week under ordinary conditions - or daily when used in a dusty place. This will get rid of large particles of dust and dirt.
2. Wipe the inside air cleaner clean with cloth if it is dirty or wet.
3. Avoid touching the element except when cleaning.
4. When dry dust adheres to the element, blow with compressed air from the inside turning the element. Pressure of compressed air must be under 686kPa (7kgf/cm<sup>2</sup>, 99psi).
5. When carbon or oil adheres to the element, soak the element in detergent for 15 minutes, then wash it several times in water, rinse with clean water and let dry naturally.
6. After the element is fully dried, inspect the inside of the element with a light, and check if it is damaged or not, (referring to the instructions on the label attached to the element.)
7. Replace the element every year or every 6 cleanings.

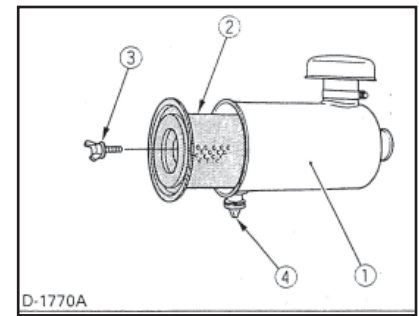

- (1) Air cleaner body
- (2) Element
- (3) Wing bolt
- (4) Evacuator valve

### !!!IMPORTANT:

- **Make sure the wing bolt for the element is tight enough. If it is loose, dust and dirt may be sucked in, wearing down the cylinder liner and piston ring earlier, and thereby resulting in poor power output.**
- **Do not over service the air cleaner element. Over servicing may cause dirt to enter the engine causing premature wear. Use the dust indicator as a guide for when to service.**

### 5-4.7.1 Dust Indicator (optional)

If the red signal on the dust indicator attached to the air cleaner is visible, the air cleaner has reached the service level.

Clean the element immediately, and reset the signal with the "RESET" button.

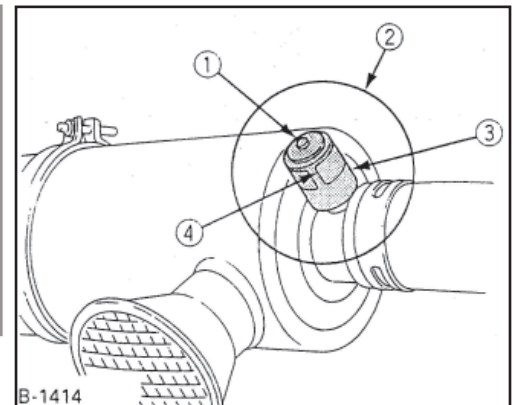

- (1) "RESET" button
- (2) Dust indicator
- (3) Service level
- (4) Signal

## 5-4.8 Battery

Mishandling of the battery shortens the service life and adds to maintenance costs. To obtain the maximum performance and the longest life of the battery handle properly and with care.

### CAUTION!!

To avoid personal injury:

- Be careful not to let the battery electrolyte contact your body or clothing.
- Wear eye protection and rubber gloves, since the diluted sulfuric acid solution burns skin and eats holes in clothing. Should this occur, immediately wash it off with running water and seek medical attention.

Engine starting will be more difficult, if the battery charge is low. Be careful to recharge before it gets too low.

### 5-4.8.1 Battery Charging

#### CAUTION!!

To avoid personal injury:

- When the battery is being activated, hydrogen and oxygen gases in the battery are extremely explosive. Keep open sparks and flames away from the battery at all times, especially when charging the battery.
- When charging the battery, remove the battery vent plugs.
- When disconnecting the cable from the battery, start with the negative terminal, and when connecting them, start with the positive terminal first.
- DO NOT check the battery charge by placing a metal object across the terminals. Use a voltmeter or hydrometer.

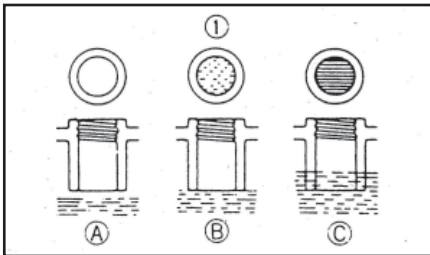

(1) Battery electrolyte level (A) "TOO LOW"  
(B) "PROPER"  
(C) "TOO HIGH"

1. Make sure each electrolyte level is at the bottom of vent wells, if necessary, add only distilled water in a well-ventilated place.
2. To slow charge the battery, connect the charger positive terminal to the battery positive terminal, and the negative to the negative, then recharge in the standard fashion.
3. Quick recharging charges the battery at a high rate in a short time. This is only for emergencies.
4. Recharge the battery as early as possible, or battery life will be extremely shortened.
5. When exchanging an old battery for a new one, use a battery of equal specifications.

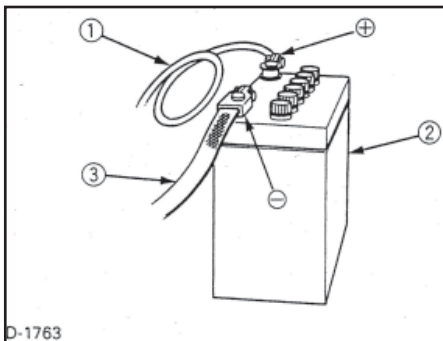

D-1763  
(1) Thick cable red (+) (2) Battery case  
(3) Earth cable black (-)

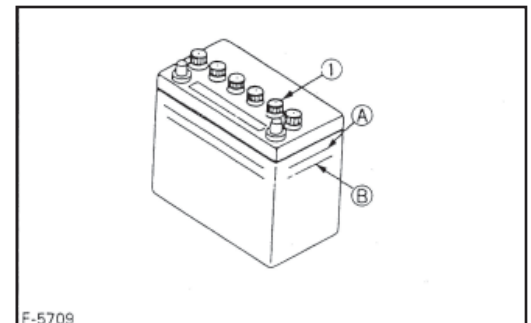

F-5709  
(1) Plug (A) "HIGHEST LEVEL"  
(B) "LOWEST LEVEL"

#### !!!IMPORTANT:

- **Connect the charger positive terminal to the battery positive terminal, and negative to the negative.**
- **When disconnecting the cable from the battery, start with the negative terminal first. When connecting the cable to the battery, start with the positive terminal first. If reversed, the contact of tools on the battery may cause a short.**

### 5-4.8.2 Directions for Long Term Storage

1. When storing the engine for long periods of time, remove the battery, adjust the electrolyte to the proper level, and store in a dry and dark place.
2. The battery naturally discharges while it is stored. Recharge it once a month in summer, and every 2 months in winter.

## 5-4.9 Electric Wiring

### CAUTION!!

To avoid personal injury:

Shorting of electric cable or wiring may cause a fire.

- Check to see if electric cables and wiring are swollen, hardened or cracked.
- Keep dust and water away from all power connections.
- Loose wiring terminal parts, make bad connections. Be sure to repair them before starting the engine.

Damaged wiring reduces the capacity of electrical parts. Change or repair damaged wiring immediately.

## 5-4.10 Fan Belt

### 5-4.10.1 Adjusting Fan Belt Tension

### CAUTION!!

To avoid personal injury:

- Be sure to stop the engine and remove the key before checking the belt tension.
- Be sure to reinstall the detached safety shield after maintenance or checking.

Proper fan belt tension	A deflection of between 7 to 9 mm (0.28 to 0.35 in.) when the belt is pressed in the middle of the span.
-------------------------	--

1. Stop the engine and remove the key.
2. Apply moderate thumb pressure to belt between pulleys.
3. If tension is incorrect, loosen the alternator mounting bolts and, using a lever placed between the alternator and the engine block, pull the alternator out until the deflection of the belt falls within acceptable limits.
4. Replace fan belt if it is damaged.

**!!!IMPORTANT: If belt is loose or damaged and the fan is damaged, it could result in overheating or insufficient charging. Correct or replace belt.**

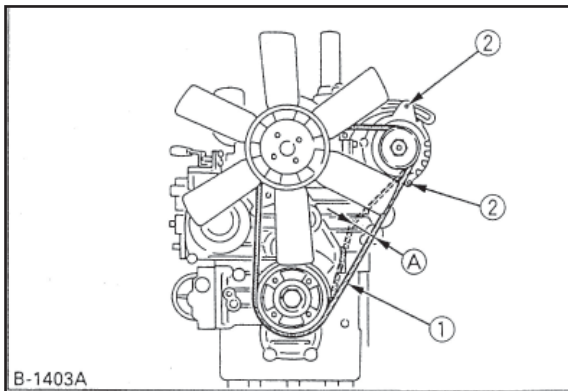

- (1) Fan belt  
 (2) Bolt and nut  
 (A) 7 to 9 mm (0.28 to 0.35 in.)  
 (under load of 10 kgf (22.1 lbs.))

## 5-4.11 Troubleshooting

If the engine does not function properly, use the following chart to identify and correct the cause.

### 5-4.11.1 When it is Difficult to Start the Engine

Cause	Countermeasures
Fuel is thick and doesn't flow.	<ul style="list-style-type: none"> <li>Check the fuel tank and fuel filter. Remove water, dirt and other impurities.</li> <li>As all fuel will be filtered by the filter, if there is water or other foreign matters on the filter, clean the filter with kerosene.</li> </ul>
Air or water mixed in fuel system	<ul style="list-style-type: none"> <li>If air is in the fuel filter or injection lines, the fuel pump will not work properly. To attain proper fuel injection pressure, check carefully for loosened fuel line coupling, loose cap nut, etc.</li> <li>Loosen joint bolt atop fuel filter and air vent screws of fuel injection pump to eliminate all the air in the fuel system.</li> </ul>
Thick carbon deposits on orifice of injection nozzle.	<ul style="list-style-type: none"> <li>This is caused when water or dirt is mixed in the fuel. Clean the nozzle injection piece, being careful not to damage the orifice.</li> <li>Check to see if nozzle is working properly or not. If not, install a new nozzle.</li> </ul>
Valve clearance is wrong.	<ul style="list-style-type: none"> <li>Adjust valve clearance to 0.145 to 0.185 mm (0.0057 to 0.0072 in.) when the engine is cold.</li> </ul>
Leaking valves	<ul style="list-style-type: none"> <li>Grind valves</li> </ul>
Fuel injection timing is wrong	<ul style="list-style-type: none"> <li>Adjust injection timing</li> <li>The injection timing 16.5° before top dead center.</li> </ul>
Engine oil becomes thick in cold weather and engine cranks slow.	<ul style="list-style-type: none"> <li>Change grade of oil according to the weather (temperature.)</li> </ul>
Low compression	<ul style="list-style-type: none"> <li>Bad valve or excessive wear of rings, pistons and liners cause insufficient compression. Replace with new parts.</li> </ul>
Battery is discharged and the engine will not crank	<ul style="list-style-type: none"> <li>Charge battery.</li> <li>In winter, always remove battery from machine, charge fully and keep indoors. Install in machine at time of use.</li> </ul>



**NOTE:** If the cause of trouble cannot be found, contact your KUBOTA Dealer.

### 5-4.11.2 When Output is Insufficient

Cause	Countermeasures
Carbon stuck around orifice of nozzle piece	<ul style="list-style-type: none"> <li>• Clean orifice and needle valve, being very careful not to damage the nozzle orifice.</li> <li>• Check nozzle to see if good. If not, replace with new parts.</li> </ul>
Compression is insufficient. Leaking valves	<ul style="list-style-type: none"> <li>• Bad valve and excessive wear of rings, pistons and liners cause insufficient compression. Replace with new parts.</li> <li>• Grind valves.</li> </ul>
Fuel is insufficient	<ul style="list-style-type: none"> <li>• Check fuel system.</li> </ul>
Overheating of moving parts	<ul style="list-style-type: none"> <li>• Check lubricating oil system.</li> <li>• Check to see if lubricating oil filter is working properly.</li> <li>• Filter element deposited with impurities would cause poor lubrication. Change element.</li> <li>• Check the clearance of bearing are within factory specs.</li> <li>• Check injection timing.</li> </ul>
Valve clearance is wrong.	<ul style="list-style-type: none"> <li>• Adjust to proper valve clearance of 0.145 to 0.185 mm (0.0057 to 0.0072 in.) with engine cold.</li> </ul>
Air cleaner is dirty	<ul style="list-style-type: none"> <li>• Clean the element every 100 hours of operation.</li> </ul>
Fuel injection pressure is wrong.	<ul style="list-style-type: none"> <li>• Adjust to proper pressure. 13.7 Mpa (140kgf/cm<sup>2</sup>, 1991psi)</li> </ul>
Injection pump wear	<ul style="list-style-type: none"> <li>• Do not use poor quality fuel as it will cause wear of the pump. Only use No. 2-D diesel fuel.</li> <li>• Check the fuel injection pump element and delivery valve assembly and replace as necessary.</li> </ul>

### 5-4.11.3 When Engine Suddenly Stops

Cause	Countermeasures
Lack of fuel	<ul style="list-style-type: none"> <li>• Check the fuel tank and refill the fuel, if necessary.</li> <li>• Also check the fuel system for air or leaks.</li> </ul>
Bad nozzle	<ul style="list-style-type: none"> <li>• If necessary, replace with a new nozzle.</li> </ul>
Moving parts are overheated due to shortage of lubrication oil or improper lubrication	<ul style="list-style-type: none"> <li>• Check amount of engine oil with oil level gauge.</li> <li>• Check lubricating oil system.</li> <li>• At every 2 times of oil change, oil filter cartridge should be replaced.</li> <li>• Check to see if the engine bearing clearances is within factory specs.</li> </ul>



**NOTE:** When the engine has suddenly stopped, decompress the engine by the decomp and turn the engine lightly by pulling on the fan belt. If the engine turns easily without abnormalities, the cause of the trouble is usually lack of fuel or bad nozzle.

### 5-4.11.4 When Color of Exhaust is Especially Bad

Cause	Countermeasures
Fuel governing device bad	<ul style="list-style-type: none"> <li>• Contact dealer for repairs.</li> </ul>
Fuel is of extremely poor quality.	<ul style="list-style-type: none"> <li>• Select good quality fuel Use No. 2-D diesel fuel only.</li> </ul>
Nozzle is bad	<ul style="list-style-type: none"> <li>• If necessary, replace with new nozzle.</li> </ul>
Combustion is incomplete	<ul style="list-style-type: none"> <li>• Cause is poor atomization, improper injection timing, etc. Because of trouble in injection system or in poor valve adjustment, or compression leakage, poor compression, etc. Check for the cause.</li> </ul>

### 5-4.11.5 When Engine Must be Stopped Immediately

Cause	Countermeasures
Engine revolution suddenly decreases or increases.	<ul style="list-style-type: none"> <li>• Check the adjustments, injection timing and the fuel system.</li> </ul>
Unusual sound is heard suddenly	<ul style="list-style-type: none"> <li>• Check all moving parts carefully.</li> </ul>
Color of exhaust suddenly turns dark	<ul style="list-style-type: none"> <li>• Check the fuel injection system, especially the fuel injection nozzle.</li> </ul>
Bearing parts are overheated.	<ul style="list-style-type: none"> <li>• Check the lubricating system.</li> </ul>
Oil lamp lights up during operation	<ul style="list-style-type: none"> <li>• Check lubricating system.</li> <li>• Check if the engine bearing clearances are within factory specs.</li> <li>• Check the function of the relieve valve in the lubricating system.</li> <li>• Check pressure switch.</li> <li>• Check filter base gasket.</li> </ul>

### 5-4.11.6 When Engine Overheats

Cause	Countermeasures
Engine oil insufficient.	<ul style="list-style-type: none"> <li>• Check oil level. Replenish oil as required.</li> </ul>
Fan belt broken or elongated	<ul style="list-style-type: none"> <li>• Change belt or adjust belt tension.</li> </ul>
Coolant insufficient	<ul style="list-style-type: none"> <li>• Replenish coolant.</li> </ul>
Excessive concentration of antifreeze	<ul style="list-style-type: none"> <li>• Add water only or change to coolant with the specified mixing ratio.</li> </ul>
Radiator net or radiator fin clogged with dust	<ul style="list-style-type: none"> <li>• Clean net or fin carefully.</li> </ul>
Inside of radiator or coolant flow route corroded	<ul style="list-style-type: none"> <li>• Clean or replace radiator and parts.</li> </ul>
Fan or radiator or radiator cap defective	<ul style="list-style-type: none"> <li>• Replace defective part.</li> </ul>
Thermostat defective	<ul style="list-style-type: none"> <li>• Check thermostat and replace if necessary.</li> </ul>
Temperature gauge or sensor defective	<ul style="list-style-type: none"> <li>• Check temperature with thermometer and replace if necessary.</li> </ul>
Overload running	<ul style="list-style-type: none"> <li>• Reduce load.</li> </ul>
Head gasket defective or water leakage	<ul style="list-style-type: none"> <li>• Replace parts.</li> </ul>
Incorrect injection timing	<ul style="list-style-type: none"> <li>• Adjust to proper timing.</li> </ul>
Unsuitable fuel used	<ul style="list-style-type: none"> <li>• Use the specified fuel.</li> </ul>

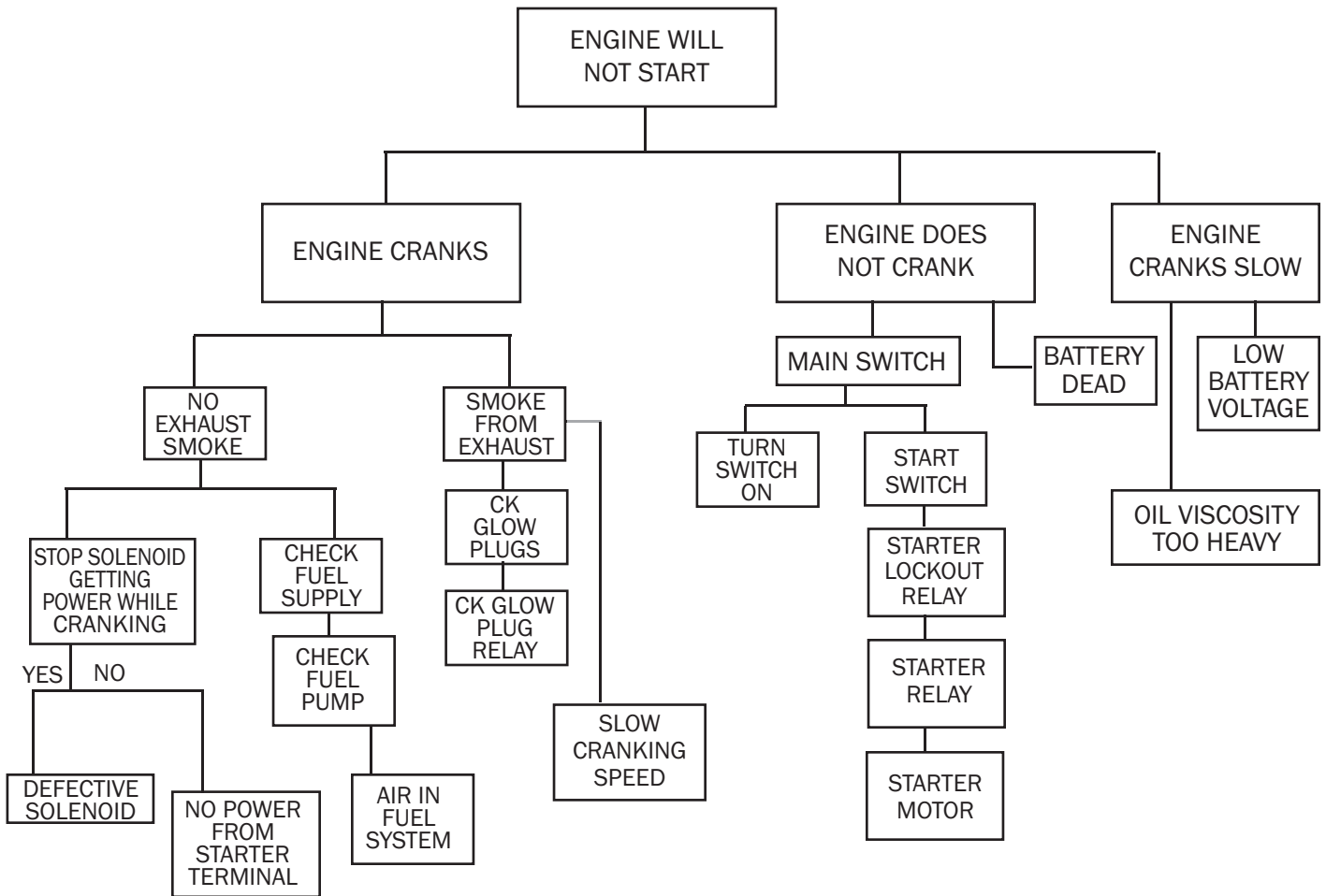



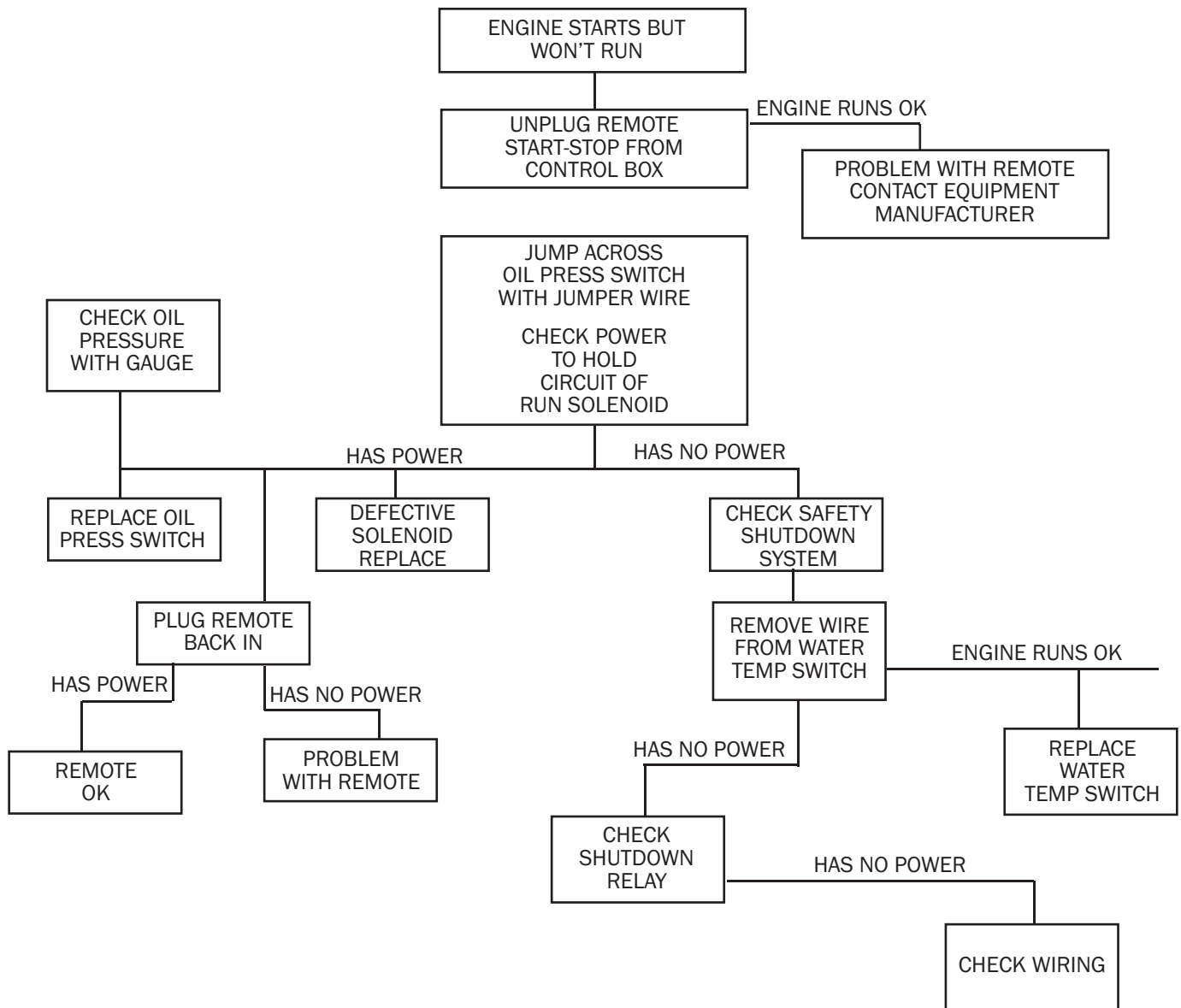

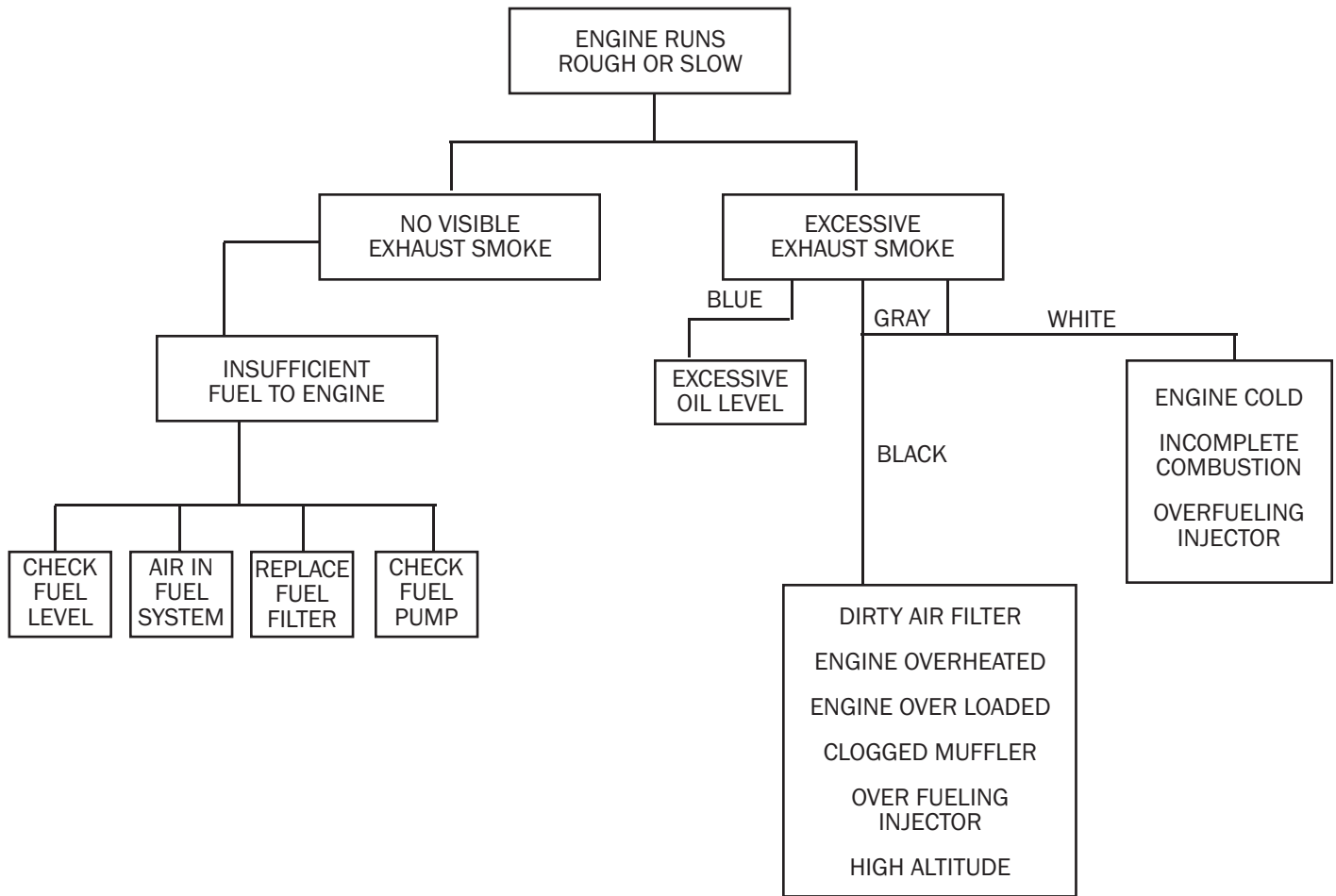

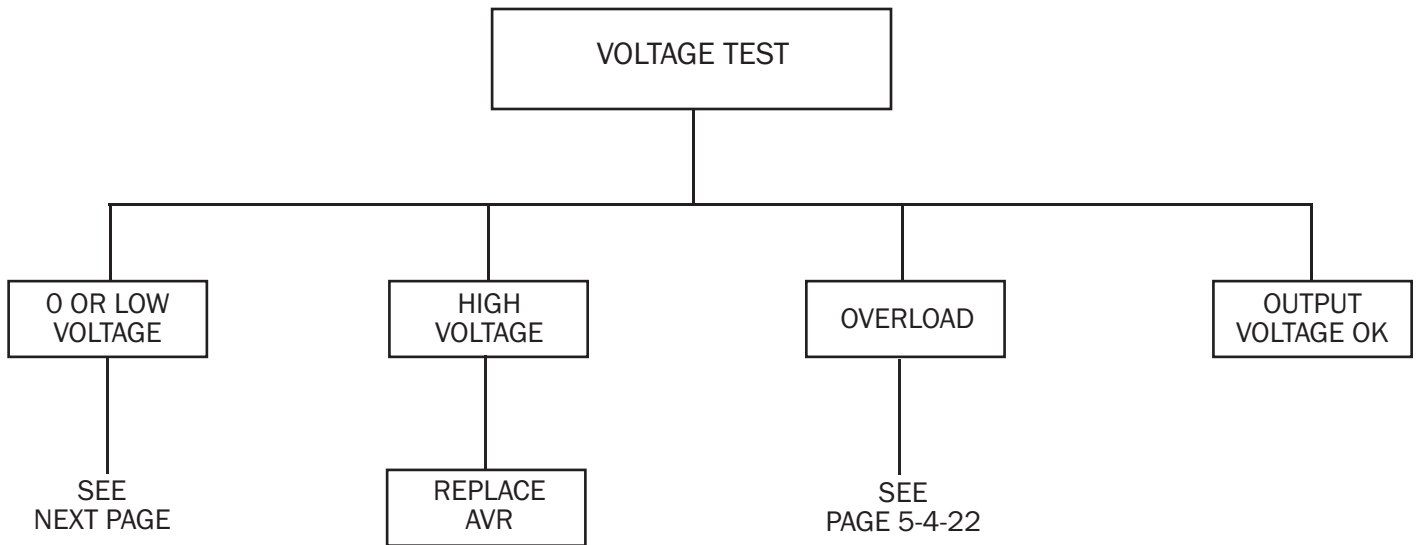

+GENTS1

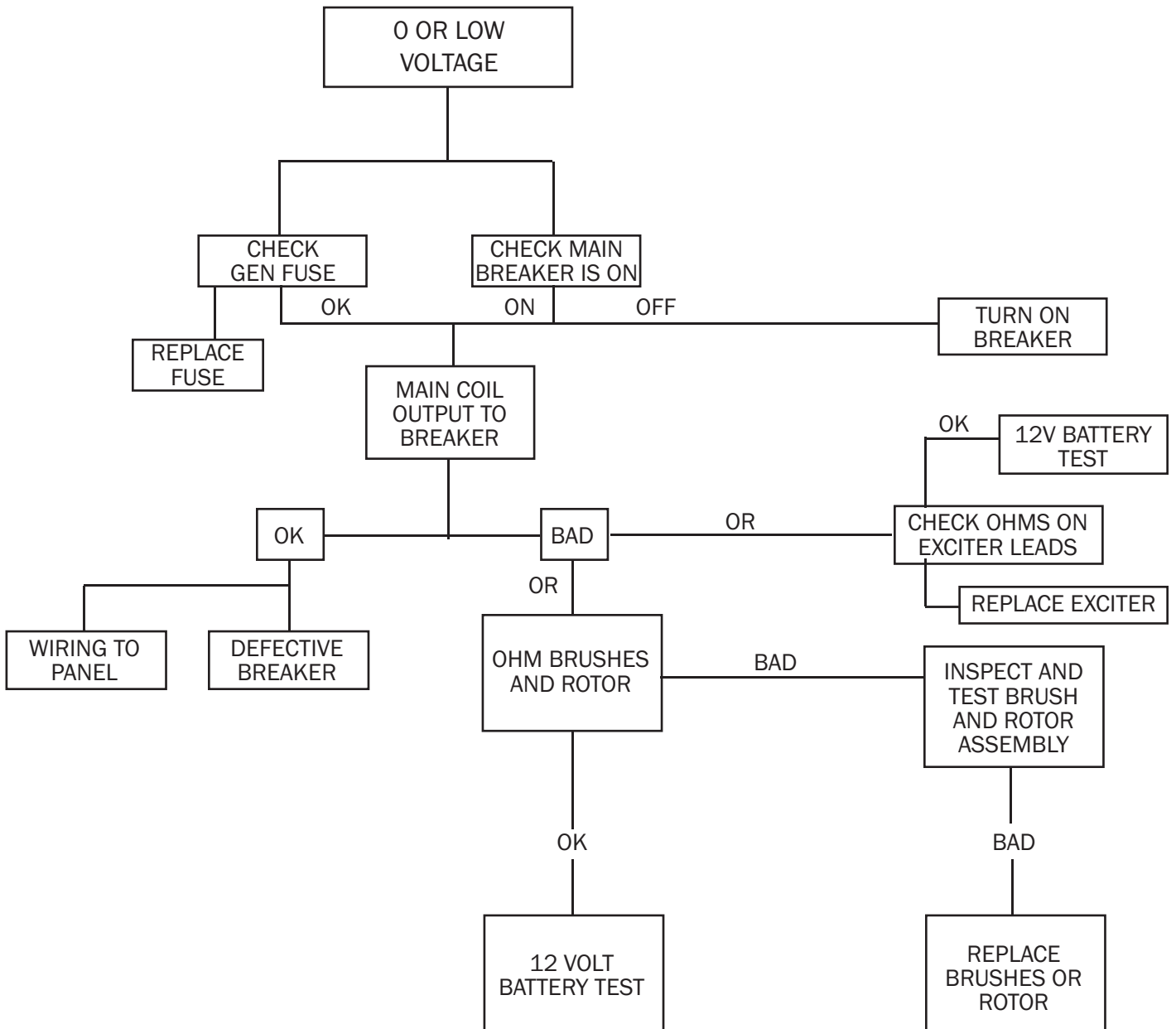

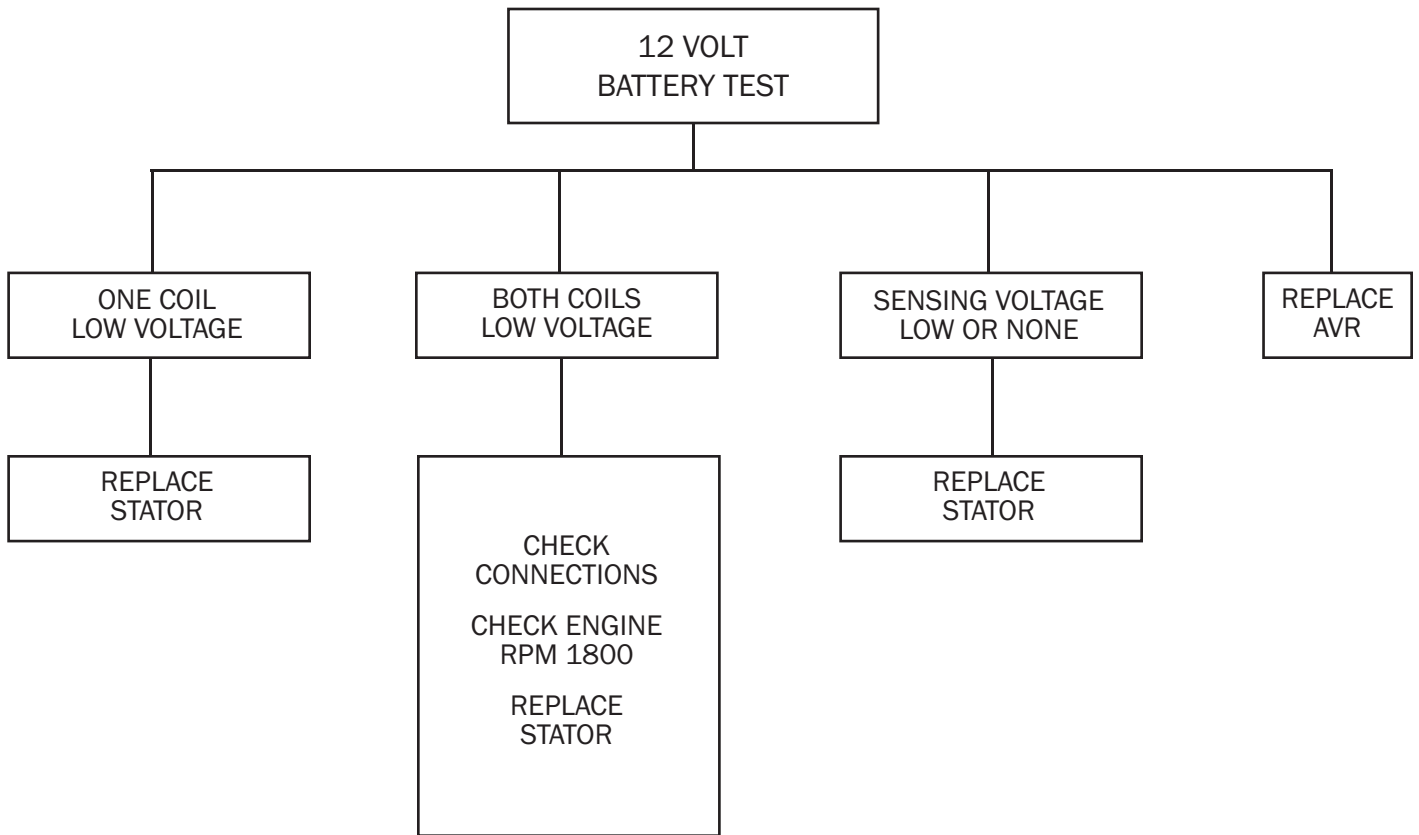

GENTS3

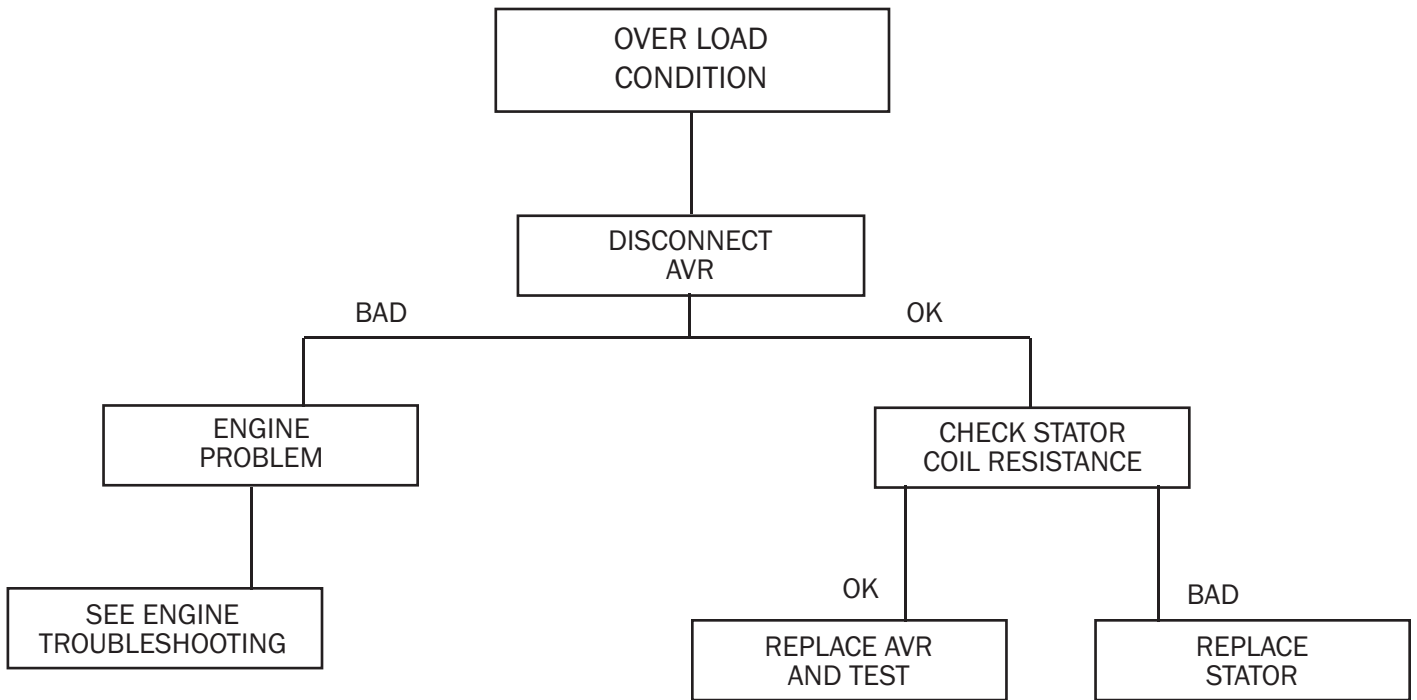

**SPECIFICATIONS VERTICAL, WATER COOLED 4 CYCLE DIESEL**

<b>POWER TECHNOLOGY</b>	15KW	TURBOCHARGED 17.5-20-25 KW	NATURALLY ASPIRATED 17.5-20 KW
<b>MODEL</b>	V-1903-BG	V-2003-T	V-2203-BG
<b>NUMBER OF CYLINDERS</b>	4	SAME	SAME
<b>BORE AND STROKE</b>	80 x 92.4 (3.15 x 3.64)	83 x 92.4 (3.27 x 3.64)	87 x 92.4 (3.43 x 3.64)
<b>TOTAL (CU. IN.) DISPLACEMENT</b>	113.32	121.99	134.07
<b>COMBUSTION CHAMBER</b>	SPHERICAL TYPE (E-TVCS)	SAME	SAME
<b>SAE NET CONTINUOUS HP/MIN (RPM)</b>	23.0/1800	33.0/1800	27.1/1800
<b>SAE STANDBY HP/MIN (RPM)</b>	26.0/1800	42.0/1800	30.6/1800
<b>ORDER OF FIRING</b>	1-3-4-2	SAME	SAME
<b>DIRECTION OF ROTATION</b>	COUNTER CLOCKWISE (VIEWED FROM FLYWHEEL SIDE)	SAME	SAME
<b>COMPRESSION RATIO</b>	23:1	22	23:1
<b>FUEL</b>	DIESEL FUL OIL NO. 2-D	SAME	SAME
<b>LUBRICATION (API CLASSIFICATION)</b>	ABOVE CD GRADE	SAME	SAME
<b>DIMENSIONS (LENGTH x WIDTH x HEIGHT)</b>	25.58 x 18.98 x 25.03	26.26 x 20.47 x 26.69	25.58 x 18.98 x 25.03
<b>STARTING SYS.</b>	CELL STARTER (WITH GLOW PLUG)	SAME	SAME
<b>STARTING MOTOR</b>	12V 1.4 KW	SAME	SAME
<b>CHARGING GENERATOR</b>	45 AMP	40 AMP	45 AMP





## 6-1 Tire/Wheel Change Procedures

### 6-1.1 Tire/Wheel Change Procedure

The wheel/tire assemblies used on your coach are heavy-duty truck-type. They are heavy and may be difficult to handle. If at all possible, changes should be accomplished by a service station equipped to handle truck equipment. However, if a situation arises where no service facilities are available, the following procedures may be used.

#### CAUTION!!

Severe injury or death may result. DO NOT use the leveling system for changing tires or working under the vehicle. Keep the rear wheels in firm contact with the ground with the parking brake set. With the leveling jacks extended, there is a possibility the vehicle may move either toward the front or the rear.



**NOTE:** Jack and lug wrench are not furnished with your coach. An outside drive axle wheel may be used to replace front or rear wheel until permanent replacement can be made. Road speed must not exceed 40 mph.

#### 6-1.1.1 Front Axle Wheels

1. Drive coach out of traffic lane onto a level surface capable of supporting jack.
2. Turn on hazard flasher and apply parking brakes before leaving coach.
3. Turn off ignition and set transmission selector to Neutral (N) position.
4. Remove white plastic wheel saver from road side rear luggage compartment.
5. Place wheel chocks against front and rear of tires on opposite side.
6. Place jack under axle and raise slightly until securely in place.

#### CAUTION!!

Bumpers are not designed for lifting and/or towing of the vehicle.

7. Pull off lug nut covers.
8. Install wheel saver.



**NOTE:** It is recommended that the wheel saver be used when loosening or torquing lug nuts.

9. Loosen lug nuts slightly, then jack up coach until tire is clear of ground. Solidly support the vehicle under the main frame rails with jack stands or blocks before working under or around the coach.



**NOTE:** Lug nuts on right side of coach are right hand threaded (turn counter-clockwise to loosen, clockwise to tighten); lug nuts on driver's side of coach are left hand threaded (turn clockwise to loosen, counter-clockwise to tighten).

10. Remove lug nuts and wheel assembly.
11. Install spare and replace lug nuts. Tighten progressively in the sequence shown on lug nut tightening sequence diagram, starting with #1 and proceeding to #10. Final torque will be 450 to 500 foot-pounds. Wheel must be on the ground for final torque.
12. Snap front hub cover into front wheel opening after front lug nuts have been properly torqued.
13. Place lug nut covers on all lug nuts. Make certain that these nut covers fit snugly. This is accomplished by squeezing the dimpled sides together before installing.
14. Lower coach to ground and remove jack and handle.
15. Replace wheel saver, lug wrench, jack and handles in storage compartment and tie down to prevent road noise. Return damaged wheel/tire assembly to holder and have it repaired as soon as possible.
16. Remove and stow wheel chocks.
17. Turn off hazard flasher before returning to traffic.

### 6-1.1.2 Drive Axle Dual Wheels

1. Repeat steps 1 through 10, Front Axle Wheels.
2. Loosen inner lug nuts (studs with square heads), if inner wheel is to be replaced.
3. Remove outer lug nuts from the (5) studs which have lock rings and slide hub cover over remaining lug nuts.
4. Remove the (5) remaining lug nuts and wheel.
5. Remove inner lug nuts and inner wheel, if inner wheel is to be replaced.
6. Install replacement wheel and inner lug nuts. Tighten progressively, in the sequence shown on lug nut tightening diagram, starting with #1 and proceeding with #10. Final torque should be between 450 and 500 foot-pounds.
7. Install outer wheel (or replacement wheel) and lug nuts over inner lug nuts marked 1, 3, 7, 9 and 6. Torque nuts in the following sequence, 1, 7, 6, 3 and 9 to between 450 and 500 foot pounds.
8. Install hub cover over the (5) lug nuts holding wheel to hub. Place lock rings and lug nuts on remaining inner lug nuts 10, 5, 2, 4 and 8.
9. Replace wheel saver.
10. Torque nuts in the following sequence 10, 2, 8, 5 and 4 to between 450 and 500 foot-pounds. Wheel must be on the ground for final torque.
11. Return to step 13 of Front Axle Wheels and continue.



**NOTE:** When checking torque on dual wheels loosen all outside lug nuts. Check torque on inner lug nuts (studs with square heads) for torque value shown above, then torque outer lug nuts to value shown above.

## 6-1.2 Tire Inflation – Towing – Trailer

### 6-1.2.1 Tire Inflation

Under-inflation causes needless tire wear and promotes excessive fuel consumption. Check tire pressures on a regular basis. The Federal Certification Label shows the cold tire inflation pressures necessary to support the Gross Axle Weight Ratings. These pressures can be reduced to greatly improve the ride quality after the actual axle weights have been determined (see [Vehicle Loading](#) in the Introduction section).

The chart below is taken from the Michelin Tire Data Book and shows the recommended tire inflation pressures for various axle weights. If any axle weight is on the borderline, always use the higher pressure. Be sure weight is distributed evenly side to side.

LOADS PER AXLE (lbs.) AT DIFFERENT PRESSURES  
 2 TIRES: SINGLE (S) 4 TIRES: DUAL (D)  
 INFLATIONS PRESSURE (psi)

		MICHELIN SIZE - 12r-22.5					MAX. SPEED - 65 MPH					
		psi	70	75	80	85	90	95	100	105	110	115
lbs.	S		9,410	9,980	10,560	11,140	11,740	12,310	12,910	13,480	14,060	14,780
	d		16,840	17,860	18,960	20,030	21,130	22,190	23,220	24,220	25,220	26,440

In addition, a tire inflation information plate is located inside the road side luggage compartment near the air gauge and hose. These are normal pressures as long as the axle weights are not in excess of those shown.

### 6-1.3.2 Towing

Two towing eyes are provided behind the upper part of the generator door. Remove generator panel for access.

**CAUTION!!**

Do not tow a vehicle equipped with Allison automatic transmission unless the drive shaft has been removed, or the rear wheels raised from the ground. Do not attempt to tow unit by front axle or cross member. Damage to wiring and/or air lines can result because of proximity of these items to front cross member. Do not tow with generator tray extended. Do not tow by the bumpers. Air pressure is required to release brakes.

### 6-1-3.3 Trailer Hitch Capacity

The Receiver Type Hitch and Drawbar are rated for a 10,000 lb. maximum towing capacity and a 1,000 lb. maximum tongue weight capacity.

Standard equipment includes a 2" hitch ball with a 1" shank rated for a 5,000 lb. maximum towing capacity and 500 lb. maximum tongue weight. Hitch ball nut must be torqued to 200 ft. lb.



**NOTE:** For more towing capacity, we offer an optional 2 5/16" hitch ball with a 1 1/4" shank rated for a 10,000 lb. maximum towing capacity and a 1,000 lb. maximum tongue weight. Hitch ball nut must be torqued to 200 ft. lb.



## 7-1 Interior/Exterior Care

### 7-1.1 Cabinets

The 450 LXi comes with several high quality cabinets. These are finished with a nitro-cellulose lacquer. Select a non-alcohol based cleaner for cleaning cabinets. Cleaners recommended for cleaning cabinets are Pledge, Endust, etc.

**!!IMPORTANT: Do not use any alcohol based cleaners. They will dull and strip the finish of the wood.**

### 7-1.2 Countertops

#### 7-1.2.1 Kitchen Countertops

The countertops are made of Centura solid surfacing material with decorative bullnose edge. Bottom row of bullnose edge is an accent color. Use cleaning agents recommended for Centura or Corian countertops.



**NOTE:** Proper care of all countertops is the owner's responsibility. Scratches will occur if proper care is not implemented. Use cleaners and cleaning materials only recommended for these types of countertops. For example, using a scrub brushes or abrasive cleaners not recommended for this type of countertop could cause unsightly scratches.



**NOTE:** Chipping of countertops is not covered under the warranty. Abrasive cleaners can cause chipping. Please take special care to avoid the chipping of countertops.

#### 7-1.2.2 Bathroom Vanity

The standard vanity top and bowl are a molded one-piece Thermolite material. A combination chrome/brass single level faucet is standard. This countertop can be cleaned with any non-abrasive cleaner designed for this type of vanity. Cleaners that are used for the kitchen countertops can be used for the vanity counters as well.



**NOTE:** Proper care of countertops is the owner's responsibility. Scratches will occur if proper care is not implemented. Use cleaners and cleaning materials only recommended for these types of countertops. For example, using a scrub brushes or abrasive cleaners not recommended for this countertop could cause unsightly scratches.

### 7-1.3 Carpet

Carpet is standard for all areas of the coach except the bathroom and kitchen. In addition loose carpet mats are included to be used on the stops. Bathroom and kitchen areas have a laminated wood or tile look floor with acoustical padding. Carpets can be cleaned with any standard carpet cleaners.

### 7-1.4 Wood Floors

Use any cleaner recommended for cleaning of wood laminate floors.

### 7-1.5 Sofa

A 78" Villa sleeper sofa is standard. Sofa is covered in fabric. Includes two throw pillows and two arm covers. Sofa can be cleaned with any standard sofa cleaner such as Woolite, etc.

### 7-1.6 Tables

Living room tables are oak wood with Centura material on the counter top to match those throughout the coach. Clean wood area with any standard furniture polish.

## 7-1.7 Window Shades

Shades should be kept in the closed or up position when not in use to maintain pleat retention and minimize dirt and soil build-up. Do not store shades in the down position. This may cause some loss of pleat retention if the shades are not operated on a consistent basis.

Shades can be easily cared for by simply dusting or using a vacuum cleaner attachment. Do not use spot remover, household cleaners or detergents to remove soiled spots, as these may cause damage or fading to the fabric.



**NOTE:** If you store your coach for an extended period of time, store shades in the up position and cover your windows with additional protection such as cardboard.

## 7-1.8 Exterior Paint

The exterior of the coach can be cleaned with the same non-abrasive cleaners used to clean your automobile.

## 7-1.9 Polished Wheels

The polished wheels can be cleaned with any cleaner designed to clean automotive polished aluminum wheels.

## 7-1.10 Glass

Use standard glass cleaner for cleaning windows on the coach.

## 7-1.11 Awnings

There are two kinds of awnings supplied with your coach. A automatic awning manufactured by Girard R.V. Products and a manual type manufactured by Zip Dee. Both awnings supplied with your coach are constructed of 100% acrylic fabric that is weatherproof, permeable to air and resistant to mildew, rotting and fading.

Acrylic fabric should be cleaned regularly before substances such as dirt, leaves, etc. are allowed to accumulate on, and become embedded in the fabric. The fabric can be cleaned without being removed from the awning. Simply brush off any loose dirt, leaves, etc. Hose down and clean with cloth and mild solution of natural soap in lukewarm water. Rinse thoroughly to remove soap. **DO NOT USE DETERGENTS.** Allow to air dry, preferably on a warm sunny day. Should you have to retract the awning when the fabric is wet, it should be extended at the first opportunity to finish air drying.



**IMPORTANT CUSTOMER NOTE:** The procedures and products recommended here are for the standard products that come with the coach. If customer selects any optional "specialty" products, please follow the cleaning and care instructions for that particular product to ensure the long life of product. Blue Bird Coachworks is not responsible for scratches, fading, or chipping, etc. resulting from improper care and maintenance procedures. It is the customer's responsibility to know what the products are made of and what they can be safely cleaned with. If unsure, check with the proper personnel upon taking delivery of your coach.

## 8-1 Miscellaneous Specifications

The various miscellaneous specifications of your new coach are listed below. For anything that is not listed here, feel free to contact your Sales Representative for full details. If options are selected from standard model, specifications may vary.

### 8-1-1 Weight Specifications

Gross Vehicle Weight Rating	52,000 lbs.
Front Gross Axle Weight Rating	16,000 lbs.
Curb	46,550 lbs. (depending on options)
Rear Gross Axle Weight Rating	23,000 lbs.
Tag Gross Axle Weight Rating	13,000 lbs.
Towing Capacity	18,500 lbs.

### 8-1-2 Measurement Specifications

Wheelbase	296"
Overall Length	44'-0"
Front Overhang	85"
Rear Overhang	99"
Floor Height	48"
Interior Height	83"
Height to Top of KVH Dome	151"
Interior Width	95"
Exterior Width	102"
Luggage Compartment Volume	235 cubic feet
Cargo Carrying Capacity	3,800 lbs. (depending on options)
Angle of Approach	7.97 deg.

### 8-1-3 Tank Capacity Specifications

Fresh Water	120 gallons
Grey Water	70 gallons
Black Water	70 gallons
Diesel Fuel	200 gallons





## 9-1 Checklists

On the next several pages you will find helpful checklists that will cover the next several trips you take along with a place to use as a journal to write noteworthy comments about where you stayed or what you did for future reference. If more pages are needed these pages may be xeroxed to use over and over again on future trips.

Trip \_\_\_\_\_ Date \_\_\_\_\_

Pre-Trip Checklist - For Residence	Packed in Coach
Store Valuables in a Safe Place	
Arrange for Pet Care	
Cover All Food to Keep Out Rodents and Insects	
Store Oil, Gasoline, Matches, etc. properly	
Suspend Deliveries such as newspapers, magazines, etc.	
Arrange with Post Office to Hold Mail	
Lock Windows and Doors Securely	
Leave Key with Neighbor or Relative and Advise Them of your itinerary	
Connect Timers to Several Outside and Inside Lights	
Arrange for Lawn Care	
<b>Things to Take Along with You on Your Trip</b>	
Supply of Prescription and Non-Prescription Medicines, (sunscreen, aspirin, etc.)	
Camera and Film Supply	
Heating Pads, Ice Bags, First Aid Materials, etc.	
Stationery, Envelopes and Stamps	
Telephone Number List	
Special Pet Supplies (medicines, shampoos, grooming supplies, etc.)	
Reading Material	
Extra Toilet Chemicals and Toilet Articles	
Spare Belts for Engine-Operated Equipment	
Spare Parts for Generator; Suggested Spare Include Oil Filter, Fuel Pump, Air Filter, Solenoid	
Five quarts of approved motor oil.	
A professional-type double-action tire pressure gauge. (included in coach)	
<b>The following Emergency Equipment is advised to have on hand:</b>	
First-Aid Kit	
Emergency Highway Flares	
Flashlight or Lantern (with extra batteries)	
Tool Kit	
Replacement Lamp Assortment	
Replacement Fuse and Breaker Assortment	
Trouble Light with a Long Cord	

<b>CHECKLISTS Continued</b>	
<b>Pre-Trip Checklist - For Coach - Outside</b>	<b>Packed in Coach</b>
Disconnect and Stow; Electrical Cord	
Sewer Hose (flush out)	
Water Hose	
Check exterior lights for proper operation	
Check wheel lug nuts for tightness (See Tire/Wheel Change Procedure)	
Check tires for correct pressure (See Tire Inflation)	
Check that all external compartments and filter openings are properly closed and/or locked	
Check that items stored on exterior coach are secured. (Be sure these items present no clearance problems)	
Check that there are no obstacles to avoid above or below coach. Be sure that there is sufficient clearance front and rear.	
<b>Automotive Systems</b>	
Check Fluid Levels are Normal: Oil	
Power Steering	
Engine Coolant	
Windshield Washer Solvent	
Transmission	
Check Generator Oil Level	
Coolant Level	
Battery Condition	
Check Turn Signals	
Emergency Flashers	
Brake Lights	
Backup Lights	
Check Headlights (high and low beam)	
Check Horn	
Start Engine and Check Gauges for Signs of Trouble	
Check that Brakes (foot and parking) are working properly	
<p>Note: If the trip you are planning will take the coach well past suggested maintenance intervals, it is advisable to perform these procedures before leaving. This may avoid unscheduled stops or interruptions during your trip.</p>	

<b>CHECKLISTS Continued</b>	
<b>Pre-Trip Checklist - For Coach - Inside</b>	<b>Done</b>
Close windows and vents	
Check that cabinet doors and drawers are secured	
Check that refrigerator door latch is in locked position	
Check that no heavy item is stored in an overhead cabinet	
Store large items in base cabinets	
Check that all doors are secured and latched	
Check that countertops, range top, table tops and shelved are clear of unsecure items	
Check that the shower latch is locked	
Turn off interior lights, check that entrance step is retracted. Secure and lock the entrance door.	
Adjust exterior mirrors	
<b>WARNING: Mirrors provide needed additional driver visibility. To be effectively used, mirrors must be properly adjusted for each driver and the driver must be aware of the limitations on viewing area that exists even when mirrors are properly used.</b>	
And Before Driving Away. . .	
Check operation of appliances and special equipment	
Check that fire extinguishers are fully charged.	
Check operation of interior and exterior lighting.	
Start generator and check 120 VAC system and wall outlets.	
Adjust driver's seat so that all controls are within easy reach	
Make sure that seat is locked in position. Do not adjust driver's seat swivel or fore/aft mechanism while vehicle is moving or the seat could move unexpectedly, causing a loss of control.	
Check that front passenger's seat is locked in position.	
Fasten seat belts. Belts should be placed as low as possible around the hips. This places the load of the body on the strong hip bone structure instead of around the soft abdominal area and prevents sliding in case of accident.	
<b>CAUTION: Child restraint systems are designed to be secured in vehicle seats by lap belts or the lap belt portion of a lap-shoulder belt. Children could be endangered in a crash if their child restraints are not properly secured in the vehicle.</b>	
Check that warning lights are lit when the ignition key is turned to the ON or START position.	



Trip \_\_\_\_\_ Date \_\_\_\_\_

Pre-Trip Checklist - For Residence	Packed in Coach
Store Valuables in a Safe Place	
Arrange for Pet Care	
Cover All Food to Keep Out Rodents and Insects	
Store Oil, Gasoline, Matches, etc. properly	
Suspend Deliveries such as newspapers, magazines, etc.	
Arrange with Post Office to Hold Mail	
Lock Windows and Doors Securely	
Leave Key with Neighbor or Relative and Advise Them of your itinerary	
Connect Timers to Several Outside and Inside Lights	
Arrange for Lawn Care	
<b>Things to Take Along with You on Your Trip</b>	
Supply of Prescription and Non-Prescription Medicines, (sunscreen, aspirin, etc.)	
Camera and Film Supply	
Heating Pads, Ice Bags, First Aid Materials, etc.	
Stationery, Envelopes and Stamps	
Telephone Number List	
Special Pet Supplies (medicines, shampoos, grooming supplies, etc.)	
Reading Material	
Extra Toilet Chemicals and Toilet Articles	
Spare Belts for Engine-Operated Equipment	
Spare Parts for Generator; Suggested Spare Include Oil Filter, Fuel Pump, Air Filter, Solenoid	
Five quarts of approved motor oil.	
A professional-type double-action tire pressure gauge. (included in coach)	
<b>The following Emergency Equipment is advised to have on hand:</b>	
First-Aid Kit	
Emergency Highway Flares	
Flashlight or Lantern (with extra batteries)	
Tool Kit	
Replacement Lamp Assortment	
Replacement Fuse and Breaker Assortment	
Trouble Light with a Long Cord	

<b>CHECKLISTS Continued</b>	
<b>Pre-Trip Checklist - For Coach - Outside</b>	<b>Packed in Coach</b>
Disconnect and Stow; Electrical Cord	
Sewer Hose (flush out)	
Water Hose	
Check exterior lights for proper operation	
Check wheel lug nuts for tightness (See Tire/Wheel Change Procedure)	
Check tires for correct pressure (See Tire Inflation)	
Check that all external compartments and filter openings are properly closed and/or locked	
Check that items stored on exterior coach are secured. (Be sure these items present no clearance problems)	
Check that there are no obstacles to avoid above or below coach. Be sure that there is sufficient clearance front and rear.	
<b>Automotive Systems</b>	
Check Fluid Levels are Normal: Oil	
Power Steering	
Engine Coolant	
Windshield Washer Solvent	
Transmission	
Check Generator Oil Level	
Coolant Level	
Battery Condition	
Check Turn Signals	
Emergency Flashers	
Brake Lights	
Backup Lights	
Check Headlights (high and low beam)	
Check Horn	
Start Engine and Check Gauges for Signs of Trouble	
Check that Brakes (foot and parking) are working properly	
<p>Note: If the trip you are planning will take the coach well past suggested maintenance intervals, it is advisable to perform these procedures before leaving. This may avoid unscheduled stops or interruptions during your trip.</p>	

<b>CHECKLISTS Continued</b>	
<b>Pre-Trip Checklist - For Coach - Inside</b>	<b>Done</b>
Close windows and vents	
Check that cabinet doors and drawers are secured	
Check that refrigerator door latch is in locked position	
Check that no heavy item is stored in an overhead cabinet	
Store large items in base cabinets	
Check that all doors are secured and latched	
Check that countertops, range top, table tops and shelved are clear of unsecure items	
Check that the shower latch is locked	
Turn off interior lights, check that entrance step is retracted. Secure and lock the entrance door.	
Adjust exterior mirrors	
<b>WARNING: Mirrors provide needed additional driver visibility. To be effectively used, mirrors must be properly adjusted for each driver and the driver must be aware of the limitations on viewing area that exists even when mirrors are properly used.</b>	
And Before Driving Away. . .	
Check operation of appliances and special equipment	
Check that fire extinguishers are fully charged.	
Check operation of interior and exterior lighting.	
Start generator and check 120 VAC system and wall outlets.	
Adjust driver's seat so that all controls are within easy reach	
Make sure that seat is locked in position. Do not adjust driver's seat swivel or fore/aft mechanism while vehicle is moving or the seat could move unexpectedly, causing a loss of control.	
Check that front passenger's seat is locked in position.	
Fasten seat belts. Belts should be placed as low as possible around the hips. This places the load of the body on the strong hip bone structure instead of around the soft abdominal area and prevents sliding in case of accident.	
<b>CAUTION: Child restraint systems are designed to be secured in vehicle seats by lap belts or the lap belt portion of a lap-shoulder belt. Children could be endangered in a crash if their child restraints are not properly secured in the vehicle.</b>	
Check that warning lights are lit when the ignition key is turned to the ON or START position.	





Trip \_\_\_\_\_ Date \_\_\_\_\_

Pre-Trip Checklist - For Residence	Packed in Coach
Store Valuables in a Safe Place	
Arrange for Pet Care	
Cover All Food to Keep Out Rodents and Insects	
Store Oil, Gasoline, Matches, etc. properly	
Suspend Deliveries such as newspapers, magazines, etc.	
Arrange with Post Office to Hold Mail	
Lock Windows and Doors Securely	
Leave Key with Neighbor or Relative and Advise Them of your itinerary	
Connect Timers to Several Outside and Inside Lights	
Arrange for Lawn Care	
<b>Things to Take Along with You on Your Trip</b>	
Supply of Prescription and Non-Prescription Medicines, (sunscreen, aspirin, etc.)	
Camera and Film Supply	
Heating Pads, Ice Bags, First Aid Materials, etc.	
Stationery, Envelopes and Stamps	
Telephone Number List	
Special Pet Supplies (medicines, shampoos, grooming supplies, etc.)	
Reading Material	
Extra Toilet Chemicals and Toilet Articles	
Spare Belts for Engine-Operated Equipment	
Spare Parts for Generator; Suggested Spare Include Oil Filter, Fuel Pump, Air Filter, Solenoid	
Five quarts of approved motor oil.	
A professional-type double-action tire pressure gauge. (included in coach)	
<b>The following Emergency Equipment is advised to have on hand:</b>	
First-Aid Kit	
Emergency Highway Flares	
Flashlight or Lantern (with extra batteries)	
Tool Kit	
Replacement Lamp Assortment	
Replacement Fuse and Breaker Assortment	
Trouble Light with a Long Cord	

<b>CHECKLISTS Continued</b>	
<b>Disconnect and Stow: Electrical Cord</b>	
Sewer Hose (flush out)	
Water Hose	
Check exterior lights for proper operation	
Check wheel lug nuts for tightness (See Tire/Wheel Change Procedure)	
Check tires for correct pressure (See Tire Inflation)	
Check that all external compartments and filter openings are properly closed and/or locked	
Check that items stored on exterior coach are secured. (Be sure these items present no clearance problems)	
Check that there are no obstacles to avoid above or below coach. Be sure that there is sufficient clearance front and rear.	
<b>Automotive Systems</b>	
<b>Check Fluid Levels are Normal: Oil</b>	
Power Steering	
Engine Coolant	
Windshield Washer Solvent	
Transmission	
<b>Check Generator Oil Level</b>	
Coolant Level	
Battery Condition	
<b>Check Turn Signals</b>	
Emergency Flashers	
Brake Lights	
Backup Lights	
Check Headlights (high and low beam)	
Check Horn	
Start Engine and Check Gauges for Signs of Trouble	
Check that Brakes (foot and parking) are working properly	
<p>Note: If the trip you are planning will take the coach well past suggested maintenance intervals, it is advisable to perform these procedures before leaving. This may avoid unscheduled stops or interruptions during your trip.</p>	

<b>CHECKLISTS Continued</b>	
<b>Pre-Trip Checklist - For Coach - Inside</b>	<b>Done</b>
Close windows and vents	
Check that cabinet doors and drawers are secured	
Check that refrigerator door latch is in locked position	
Check that no heavy item is stored in an overhead cabinet	
Store large items in base cabinets	
Check that all doors are secured and latched	
Check that countertops, range top, table tops and shelved are clear of unsecure items	
Check that the shower latch is locked	
Turn off interior lights, check that entrance step is retracted. Secure and lock the entrance door.	
Adjust exterior mirrors	
<b>WARNING: Mirrors provide needed additional driver visibility. To be effectively used, mirrors must be properly adjusted for each driver and the driver must be aware of the limitations on viewing area that exists even when mirrors are properly used.</b>	
And Before Driving Away. . .	
Check operation of appliances and special equipment	
Check that fire extinguishers are fully charged.	
Check operation of interior and exterior lighting.	
Start generator and check 120 VAC system and wall outlets.	
Adjust driver's seat so that all controls are within easy reach	
Make sure that seat is locked in position. Do not adjust driver's seat swivel or fore/aft mechanism while vehicle is moving or the seat could move unexpectedly, causing a loss of control.	
Check that front passenger's seat is locked in position.	
Fasten seat belts. Belts should be placed as low as possible around the hips. This places the load of the body on the strong hip bone structure instead of around the soft abdominal area and prevents sliding in case of accident.	
<b>CAUTION: Child restraint systems are designed to be secured in vehicle seats by lap belts or the lap belt portion of a lap-shoulder belt. Children could be endangered in a crash if their child restraints are not properly secured in the vehicle.</b>	
Check that warning lights are lit when the ignition key is turned to the ON or START position.	



# 10-1 Authorized Service Centers

## Authorized Blue Bird Coachworks Dealers and Service Centers

### Blue Bird Coachworks

One Wanderlodge Way • P.O. Box 1259  
Fort Valley, GA 31030  
478-822-2400

Factory Sales – 478-822-2407 – Ronnie Lamb  
Factory Service – 800-992-6337 – Mike Burkett and Kenny Rodgers  
Product Technical Support – 800-992-6337 – Russell Borders and Bennie Collier  
Factory Parts Sales – 800-495-7787 – Earl Davis and Ray Horne

### Sales and Service

#### HOLLAND MOTOR HOMES

[www.holland-motorhomes.com](http://www.holland-motorhomes.com)

670 East 16th Street  
Holland, MI 49423  
(800) 221-7197 - Phone  
(616) 396-1391 - Fax  
GM / Sales Mgr.: John Dykstra  
Service Mgr.: Mike Meulenberg

#### HOLLAND MOTOR HOMES

[www.hollandmotorhomes.com](http://www.hollandmotorhomes.com)

7490 Copley Park Place  
San Diego, CA 92111  
(800) 961-4464 - Phone  
(858) 874-8484 - Fax  
GM / Sales Mgr.: John Dykstra  
Service Mgr.: Mike Meulenberg

#### PARLIAMENT COACH CORPORATION

[www.parliamentcoach.com](http://www.parliamentcoach.com)

13790 B Roosevelt Blvd.  
Clearwater, FL 33762  
(888) 571-5755 - Phone  
(727) 561-0227 - Fax  
Owner: Harvey Mitchell  
Present / GM: Steve Mitchell  
Service Mgr.: Rick May

#### SHOREWOOD RV CENTER

[www.shorewoodrv.com](http://www.shorewoodrv.com)

8390 Highway 10 NW  
Anoka, MN 55303  
(800) 784-2505 - Phone  
(763) 506-0415 - Fax  
Sales Mgr.: Tim Paulson  
Service Mgr.: Terry Morical

#### MOTOR HOME SPECIALIST

[www.mhsrv.com](http://www.mhsrv.com)

5411 S. I-35 W  
Alvarado, TX 76009  
(800) 335-6054 - Phone  
(817) 783-6395 - Fax  
Sales Mgr.: Robert Brake  
Service Mgr.: Terry Humphries

## Authorized Blue Bird Coachworks Service Centers

### Full Service and Parts Only

Miller's RV

12912 Florida Boulevard • Baton Rouge, LA 70815  
(504) 275-2940 • Fax: (504) 275-6807  
Service – Doug Miller

---

## Authorized Blue Bird Coachworks Service Centers

### Detroit Diesel – Allison And Associate DD-A Distributors

### Chassis Service and Chassis Parts Only

#### **ALABAMA**

##### **Birmingham**

William Detroit Diesel -  
Allison Southeast, Inc.  
1160 Bankhead Hwy., West  
P.O. Box 12566  
Birmingham, AL 35202  
Phone: 800-365-3780

#### **ALASKA**

##### **Anchorage**

Pacific Detroit Diesel -  
Allison Co.  
8001 Petersburg Street  
Anchorage, AK 99507  
Phone: 907-522-3434

#### **ARIZONA**

##### **Phoenix**

Williams Detroit Diesel -  
Allison Southwest, Inc.  
2602 S. 19th Ave.  
(Zip 85009)  
P.O. Box 3618  
Phoenix, AZ 85030  
Phone: 800-944-7375

##### **Tucson**

Williams Detroit Diesel -  
Allison Southwest, Inc.  
1375 W. Glenn  
Tucson, AZ 85705  
Phone: 800-624-8331

#### **ARKANSAS**

##### **Little Rock**

United Engines, Inc.  
9401 I-30 (Zip 72209)  
P.O. Box 192720  
Little Rock, AR 72219  
Phone: 501-562-5565

#### **CALIFORNIA**

##### **Bakersfield**

Valley Detroit Diesel - Allison, Inc.  
4000 Rosedale Hwy.  
(Zip 93308)  
P.O. Box 1848  
Bakersfield, CA 93303  
Phone: 805-325-9001

##### **City of Industry**

Valley Detroit Diesel - Allison, Inc.  
13644 E. Nelson Ave.  
City of Industry, CA 91746  
Phone: 818-333-1243

##### **Fresno**

Valley Detroit Diesel - Allison, Inc.  
2935 S. Orange Ave.  
Fresno, CA 93725  
Phone: 209-486-6900

##### **Mira Loma**

Valley Detroit Diesel - Allison, Inc.  
11300 Inland Avenue  
Mira Loma, CA 91752  
Phone: 909-681-9283

##### **San Diego**

Valley Detroit Diesel - Allison, Inc.  
5725 Eastgate Drive  
San Diego, CA 92121  
Phone: 619-447-2492

##### **San Leandro**

Sierra Detroit Diesel - Allison, Inc.  
1755 Adams Avenue  
San Leandro, CA 94577  
Phone: 510-635-8991

##### **West Sacramento**

Sierra Detroit Diesel - Allison, Inc.  
855 Stillwater Road  
West Sacramento,  
CA 95691  
Phone: 916-372-5078

#### **COLORADO**

##### **Commerce City**

Stewart & Stevenson Power, Inc.  
5840 Dahlia Street (Denver)  
P.O. Box 220  
Commerce City, CO 80022  
Phone: 303-287-7441

#### **CONNECTICUT**

##### **Middletown**

Atlantic Detroit Diesel - Allison, Inc.  
300 Smith Street  
P.O. Box 2781  
Middletown, CT 06457  
Phone: 203-632-0218

##### **Noank**

Atlantic Detroit Diesel - Allison, Inc.  
Noank Shipyard  
Pearl Street  
Noank, CT 06340  
Phone: 203-536-6726

#### **FLORIDA**

##### **Ft. Myers**

Florida Detroit Diesel - Allison, Inc.  
2305 Rockfille Road  
Ft. Myers, FL 33916  
Phone: 813-332-3100

##### **Ft. Pierce**

Florida Detroit Diesel - Allison, Inc.  
3885 Selvitz Road  
Ft. Pierce, FL 34954  
Phone: 407-464-6006

**FLORIDA cont.****Jacksonville**

Florida Detroit Diesel - Allison North, Inc.  
5040 University Blvd. West  
(Zip 32216)  
Jacksonville, FL 32245-6595  
Phone: 904-737-7330

**Miami**

Florida Detroit Diesel - Allison, Inc.  
2277 N.W. 14th Street  
(Zip: 33125)  
P.O. Box 350010  
Miami, FL 33195  
Phone: 305-638-5300

**Ocala**

Florida Detroit Diesel - Allison North Inc.  
224 S. W. 52nd Ave.  
Ocala, FL 32674  
Phone: 904-237-7977

**Orlando**

Florida Detroit Diesel - Allison North, Inc.  
6850 Presidents Drive  
Orlando, FL 32809  
Phone: 407-888-1700

**Tampa**

Florida Detroit Diesel - Allison North, Inc.  
8411 Adamo Drive  
Tampa, FL 33619  
Phone: 813-621-5651

**GEORGIA****Albany**

Williams Detroit Diesel - Allison Southeast, Inc.  
1803 West Oakridge Drive  
Albany, GA 31707  
Phone: 800-736-1952

**Atlanta**

Williams Detroit Diesel -  
Allison Southeast, Inc.  
2849 Moreland Ave. S.E.  
P.O. Box 12537  
Atlanta, GA 30315  
Phone: 800-545-7116

**Ringgold**

Covington Detroit Diesel  
102 Gateway Avenue  
P.O. Box 1088  
Ringgold, GA 30736  
Phone: 706-965-7000

**Savannah**

Williams Detroit Diesel -  
Allison Southeast, Inc.  
14 West Gate Blvd.  
P.O. Box 23209  
Savannah, GA 31405  
Phone: 800-283-9332

**IDAHO****Boise**

Smith Detroit Diesel - Allison, Inc.  
4045 Transport Street  
P.O. Box 5715  
Boise, ID 83705  
Phone: 208-345-1500

**ILLINOIS****Addison**

Inland Detroit Diesel - Allison, Inc.  
500 S. Lombard Road  
(Chicago)  
Addison, IL 60101  
Phone: 708-620-2000

**Rock Island**

Interstate Detroit Diesel, Inc.  
3806 78th Ave., West  
Rock Island, IL 61201  
Phone: 309-787-4601

**INDIANA****Fort Wayne**

Clarke Detroit Diesel - Allison, Inc.  
2610 Independence Drive  
Fort Wayne, IN 46825  
Phone: 219-482-9185

**Gary**

Inland Detroit Diesel - Allison, Inc.  
2601 E. 15th Street  
Gary, IN 46401  
Phone: 219-882-0421

**Indianapolis**

Clarke Detroit Diesel - Allison, Inc.  
1340 Terminal Road  
Indianapolis, IN 46217  
Phone: 317-783-6651

**IOWA****Des Moines**

Interstate Detroit Diesel, Inc.  
Interstate Hwys. 80 & 35 at  
2nd Avenue  
P.O. Box 4007  
Des Moines, IA 50333  
Phone: 515-286-4800

**KANSAS****Colby**

Central Detroit Diesel - Allison, Inc.  
1920 Thielen Ave.  
P.O. Box 445  
Colby, KS 67701  
Phone: 913-462-8211

**Great Bend**

Central Detroit Diesel - Allison, Inc.  
625 E. 10th Street  
P.O. Box 691  
Great Bend, KS 67530  
Phone: 316-792-1361

**Liberal**

Central Detroit Diesel - Allison, Inc.  
East Hwy. 54  
P.O. Box 177  
Liberal, KS 67901  
Phone: 316-624-7274

**Salina**

Central Detroit Diesel - Allison, Inc.  
1944-B N. 9th Street  
P.O. Box 1271  
Salina, KS 67401  
Phone: 913-825-8291

**Wichita**

Central Detroit Diesel -  
Allison, Inc.  
4501 W. Irving  
Wichita, KS 67201  
Phone: 316-943-1231

**KENTUCKY****Henderson**

Clarke Detroit Diesel - Allison, Inc.  
751 U.S. 41 South  
Henderson, KY 42420  
Phone: 502-827-4600

**Lost Creek**

Western Brance Diesel, Inc.  
14701 Highway 15 South  
Lost Creek, KY 41348  
Phone: 606-666-4981

**Louisville**

Clarke Detroit Diesel - Allison, Inc.  
2697 Gassland Avenue  
Louisville, KY 40299  
Phone: 502-491-2021

**LOUISIANA****Harvey**

Stewart & Stevenson Services, Inc.  
1401 Destrehan Ave.  
P.O. Box 8  
Harvey, LA 70059  
Phone: 504-347-4326

**Shreveport**

United Engines, Inc.  
7255 Greenwood Road  
P.O. Box 37270  
Shreveport, LA 71133  
Phone: 318-635-8022

**MAINE****Portland**

New England Detroit Diesel - Allison, Inc.  
432 Warren Avenue  
Portland, ME 04103  
Phone: 207-797-5950  
Fax: 207-797-5953

**MARYLAND****Baltimore**

Johnson & Towers, Inc.  
500 Wilson Point Road  
Baltimore, MD 21220  
Phone: 410-687-0500

**Beltsville**

Johnson & Towers, Inc.  
6861 Distribution Drive  
Beltsville, MD 20705  
Phone: 301-937-8700

**MASSACHUSETTS****Wakefield**

New England Detroit Diesel Allison, Inc.  
90 Bay State Road  
(Boston)  
Wakefield, MA 01880  
Phone: 617-246-1810

**MICHIGAN****Dearborn**

Williams Detroit Diesel -  
Allison Midwest, Inc.  
4000 Stecker Avenue  
Dearborn, MI 48126-6150  
Phone: 313-584-6150  
(24 Hr.)

**Grand Rapids**

Williams Detroit Diesel -  
Allison Midwest, Inc.  
2940 Clydon Ave. S.W.  
Grand Rapids, MI 49509  
Phone: 800-701-9993

**Iron Mountain**

Inland Diesel, Inc.  
600 Industrial Park Drive  
Iron Mountain, MI 49801  
Phone: 906-774-9707

**Saginaw**

Williams Detroit Diesel -  
Allison Midwest, Inc.  
715 S. Outer Drive  
Saginaw, MI 48601  
Phone: 800-906-4235

**MINNESOTA****Minneapolis**

Interstate Detroit Diesel, Inc.  
2501 E. 80th Street  
Minneapolis, MN 55425  
Phone: 612-854-5511

**Virginia**

Interstate Detroit Diesel, Inc.  
1921 16th Ave., West  
Virginia, MN 55792  
Phone: 218-749-4484

**MISSISSIPPI****Jackson**

Clarke Detroit Diesel - Allison  
620 Hwy. 49 South  
(Zip: 39218)  
P.O. Box 6274  
Jackson, MS 39288  
Phone: 601-932-2424

**MISSOURI****Liberty**

Central Detroit Diesel - Allison, Inc.  
9200 Liberty Drive  
P.O. Box 490  
Liberty, MO 64068  
Phone: 816-781-8070

**St. Louis**

Clarke Detroit Diesel - Allison, Inc.  
1424 Ashby Road  
P.O. Box 21593  
St. Louis, MO 83132  
Phone: 314-429-2131

**MONTANA****Billings**

Interstate Detroit Diesel, Inc.  
1140 Main  
P.O. Box 30518  
Billings, MT 59107  
Phone: 406-252-4191

**Missoula**

Interstate Detroit Diesel, Inc.  
3757 N. Reserve Street  
P.O. Box 8125  
Missoula, MT 59807  
Phone: 406-728-7600

**NEBRASKA****Omaha**

Interstate Detroit Diesel, Inc.  
6969 S. 107th Street  
Omaha, NE 68128  
Phone: 402-331-4104

**NEVADA****Battle Mountain**

Smith Detroit Diesel - Allison, Inc.  
680 W. Front Street  
P.O. Box 1288  
Battle Mountain, NV 89820  
Phone: 702-635-5477

**Elko**

Smith Detroit Diesel - Allison, Inc.  
4900 E. Idaho  
Elko, NV 89801  
Phone: 702-738-7154

**North Las Vegas**

Williams Detroit Diesel -  
Allison Southwest, Inc.  
2680 Losee Road  
North Las Vegas, NV 89030  
Phone: 702-399-1890

**Sparks**

Smith Detroit Diesel - Allison, Inc.  
8 Glendale Avenue  
P.O. Box 1167  
Sparks, NV 89431  
Phone: 702-359-1713



**NEW JERSEY****Lodi**

Atlantic Detroit Diesel -  
180 Route 17 South  
P.O. Box 950  
Lodi, NJ 07644  
Phone: 201-489-5800 NJ  
Phone: 212-665-1500 NY

**Mount Laurel**

Johnson & Towers, Inc.  
2021 Briggs Road  
P.O. Box 4000  
Mount Laurel, NJ 08054  
Phone: 609-234-6990

**Piscataway**

Atlantic Detroit Diesel - Allison, Inc.  
169 Old New Brunswick Rd.  
Piscataway, NJ 08854  
Phone: 908-752-7100

**Pleasantville**

Johnson & Towers, Inc.  
740 Delilah Road  
(Rear Bldg.)  
Pleasantville, NJ 08232  
Phone: 609-272-1415

**NEW MEXICO****Albuquerque**

Stewart & Stevenson Power, Inc.  
2929 Vassar Drive N.E.  
Albuquerque, NM 87107  
Phone: 505-881-3511

**Farmington**

Stewart & Stevenson Power, Inc.  
1515 West Murray Drive  
Farmington, NM 87401  
Phone: 505-325-5071

**NEW YORK****Albany**

Atlantic Detroit Diesel - Allison, Inc.  
17 Commercial Avenue  
Albany, NY 12205  
Phone: 518-438-5961

**Buffalo**

Penn Detroit Diesel - Allison, Inc.  
350 Bailey Avenue  
Buffalo, NY 14210  
Phone: 716-823-7242

**Ronkonkoma, Long Island**

Atlantic Detroit Diesel - Allison, Inc.  
3025 Veterans Memorial Hwy.  
Ronkonkoma, Long Island,  
NY 11779  
Phone: 516-981-5800

**Syracuse**

Penn Detroit Diesel - Allison, Inc.  
7044 Interstate Island Rd.  
Syracuse, NY 13209  
Phone: 315-451-3840

**NORTH CAROLINA****Charlotte**

Covington Detroit Diesel -  
1815 Starita Road  
P.O. Box 26653  
Charlotte, NC 28213  
Phone: 704-596-8000

**Greensboro**

Covington Detroit Diesel -  
6200 Swiggett Road  
P.O. Box 18949  
Greensboro, NC 27419-8949  
Phone: 910-292-9240

**Morehead City**

Covington Detroit Diesel -  
210 Arendell Street  
Morehead City, NC 28557  
Phone: 919-726-9881

**New Bern**

Covington Detroit Diesel -  
U.S. Hwy. 17 South  
P.O. Box 12626  
New Bern, NC 28560  
Phone: 919-638-3161

**Wilmington**

Covington Detroit Diesel  
6725 Netherlands Drive  
Wilmington, NC 28405  
Phone: 919-392-7220

**NORTH DAKOTA****Bismarck**

Interstate Detroit Diesel, Inc.  
3801 Commerce Drive  
Bismarck, ND 58501  
Phone: 701-258-2303

**Fargo**

Interstate Detroit Diesel, Inc.  
3902 12th Ave. North  
Fargo, ND 58102  
Phone: 701-282-6558

**Grand Forks**

Interstate Detroit Diesel, Inc.  
1003 South 48th St.  
Grand Forks, ND 58201  
Phone: 701-746-0354

**Williston**

Interstate Detroit Diesel, Inc.  
3805 4th Avenue West  
P.O. Box 880  
Williston, ND 58801  
Phone: 701-572-2000

**OHIO****Akron**

Williams Detroit Diesel - Allison Midwest, Inc.  
1395 Triplett Blvd.  
Akron, OH 44306  
Phone: 216-794-1535

**Brunswick**

Williams Detroit Diesel - Allison Midwest, Inc.  
1176 Industrial Pwky. N  
Brunswick, OH 44212-2342  
Phone: 216-225-7751

**Canton**

Western Branch Diesel, Inc.  
1616 Metric Ave., S.W.  
Canton, OH 44706  
Phone: 216-454-8800

**Cincinnati**

Clarke Detroit Diesel - Allison, Inc.  
3133 E. Kemper Rd.  
(Sharonville)  
Cincinnati, OH 45241  
Phone: 513-771-2200

**Hubbard**

Williams Detroit Diesel - Allison Midwest, Inc.  
7125 Masury Rd. Southeast  
(Youngstown)  
P.O. Box 71  
Hubbard, OH 44425  
Phone: 216-534-1161

**Lemoyne**

Williams Detroit Diesel - Allison Midwest, Inc.  
3325 Libby Road (Toledo)  
P.O. Box 427  
Lemoyne, OH 43441  
Phone: 419-837-5067

**OHIO Cont.****Wintersville**

Western Branch Diesel, Inc.  
286 Luray Drive  
(Steubenville)  
P.O. Box 2069  
Wintersville, OH 43952  
Phone: 614-264-7121

**OKLAHOMA****Oklahoma City**

United Engines, Inc.  
5555 W. Reno Street  
(Zip 73127)  
P.O. Box 75079  
Oklahoma City, OK 73147  
Phone: 405-947-3321

**Tulsa**

United Engines, Inc.  
7454 E. 41st Street  
Tulsa, OK 74145  
Phone: 918-627-8080

**Woodward**

Central Detroit Diesel - Allison, Inc.  
U.S. Hwy. 270 N.W.  
P.O. Box 1145  
Woodward, OK 73802  
Phone: 405-256-6014

**OREGON****Medford**

Pacific Detroit Diesel - Allison Co.  
1493 Kingsley Drive  
Medford, OR 97504  
Phone: 503-779-4622

**Portland**

Pacific Detroit Diesel - Allison Co.  
5061 N. Lagoon Ave.  
Swan Island  
Portland, OR 97217-7694  
Phone: 503-283-0505

**Springfield**

Pacific Detroit Diesel - Allison Co.  
3436 Olympic Street  
Springfield, OR 97477  
Phone: 503-746-1661

**PENNSYLVANIA****Bedford**

Penn Detroit Diesel - Allison, Inc.  
Route 220 North  
P.O. Box 147  
Bedford, PA 15522  
Phone: 814-623-6171

**Fleetwood**

Penn Detroit Diesel - Allison, Inc.  
Route 222  
P.O. Box 187  
Fleetwood, PA 19522  
Phone: 215-944-0451

**Philadelphia**

Penn Detroit Diesel - Allison, Inc.  
8330 State Road  
Philadelphia, PA 19136-2996  
Phone: 215-335-0500

**York Haven**

Penn Detroit Diesel - Allison, Inc.  
Sipe Rd., R.D. 1  
(Exit 13 - I-83)  
York Haven, PA 17370  
Phone: 717-938-5141

**Zelienople**

Penn Detroit Diesel - Allison, Inc.  
11 Progress Road  
(U.S. Hwy. 19th North)  
(Pittsburgh)  
Zelienople, PA 16063  
Phone: 412-776-3237

**SOUTH CAROLINA****Greer**

Williams Detroit Diesel -  
Allison Southeast, Inc.  
1835 S. Highway 101  
Greer, SC 29651  
Phone: 803-877-0935

**West Columbia**

Williams Detroit Diesel -  
Allison Southeast, Inc.  
2610 Augusta Hwy.  
(U.S. 1 7 I-26)  
West Columbia, SC 29169  
Phone: 800-452-8479

**SOUTH DAKOTA****Rapid City**

Interstate Detroit Diesel, Inc.  
1947 Deadwood Ave.  
P.O. Box 508  
Rapid City, SD 57709  
Phone: 605-348-0374

**TENNESSEE****Kingsport**

Covington Detroit Diesel  
Hwy. 137 & Rock  
Springs Rd.  
P.O. Box 5417  
Kingsport, TN 37663  
Phone: 615-349-6141

**Knoxville**

Covington Detroit Diesel  
1500 Breda Drive  
(Zip 37918)  
P.O. Box 18560  
Knoxville, TN 37928  
Phone: 615-689-3722

**Memphis**

Clarke Detroit Diesel - Allison  
3070 Sandbrook St.  
(Zip 38116)  
P.O. Box 16260  
Memphis, TN 38186-0260  
Phone: 901-396-7320

**Nashville**

Covington Detroit Diesel  
80 Cleveland Street  
Nashville, TN 37210  
Phone: 615-262-4141

**TEXAS****Amarillo**

Stewart & Stevenson Power, Inc.  
I-10 at Pullman Road  
P.O. box 31986  
Amarillo, TX 79120-1986  
Phone: 806-335-2828

**Beaumont**

Stewart & Stevenson Services, Inc.  
U.S. Hwy. 69 South  
& Beauxart Garden Rd.  
Route 4, Box 89  
Beaumont, TX 77705  
Phone: 409-727-1436 (24 Hr.)

**Corpus Christi**

Stewart & Stevenson Services, Inc.  
6530 Agnes St.  
P.O. Box 4975  
Corpus Christi, TX 78469-4975  
Phone: 512-289-5350 (24 Hr.)

**TEXAS Cont.****Dallas**

Stewart & Stevenson Services, Inc.  
3919 Irving Blvd.  
P.O. Box 560343  
Dallas, TX 75356-0343  
Phone: 214-631-5370  
(24 Hr.)

**Houston**

Stewart & Stevenson Services, Inc.  
2707 N. Loop West  
P.O. Box 1637  
Houston, TX 77251-1637  
Phone: 713-868-7700

**Houston**

Stewart & Stevenson Services, Inc.  
8631 E. Freeway  
Houston TX 77029  
Phone: 713-671-6220

**Lubbock**

Stewart & Stevenson Power, Inc.  
2000 Station Hwy.  
P.O. Box 2529  
Lubbock, TX 79408  
Phone: 806-745-4224

**Odessa**

Stewart & Stevenson Power, Inc.  
11120 W. Hwy. 80 East  
(Zip 79765)  
P.O. Box 2848  
Odessa, TX 79760  
Phone: 915-563-4800

**San Antonio**

Stewart & Stevenson Services, Inc.  
5717 I-10 East  
P.O. Box 201330  
San Antonio, TX 78220-8330  
Phone: 210-662-1000

**Wichita Falls**

Stewart & Stevenson Services, Inc.  
2301 Central Freeway East  
(Zip 76302)  
P.O. Box 839  
Wichita Falls, TX 76307-0839  
Phone: 817-322-5227

**UTAH****Salt Lake City**

Smith Detroit Diesel - Allison, Inc.  
250 W. 3900 S.  
(Zip 84107)  
P.O. Box 27527  
Salt Lake City, UT 84127  
Phone: 801-262-2831

**Vernal**

Smith Detroit Diesel - Allison, Inc.  
U.S. Hwy. 40 East  
P.O. Box 1122  
Vernal, UT 84078  
Phone: 801-789-1860

**VIRGINIA****Portsmouth**

Western Branch Diesel, Inc.  
3504 Shipwright Street  
(Zip 23703)  
P.O. Box 7788  
Portsmouth, VA 23707-0788  
Phone: 804-484-6230

**Richmond**

Western Branch Diesel, Inc.  
(I-95 North at Atlee Road)  
(Ashland, VA 23005)  
P.O. Box 9730  
Richmond, VA 23228  
Phone: 804-550-2816

**Roanoke**

Western Branch Diesel, Inc.  
4546 Thirlane Road,  
Northwest  
Roanoke, VA 24019  
Phone: 703-362-1608

**Springfield**

Western Branch Diesel, Inc.  
8102 Alban Road  
Springfield, VA 22150  
Phone: 703-569-5650

**WASHINGTON****Kent**

Pacific Detroit Diesel - Allison, Co.  
7215 S. 228th Street  
Kent, WA 98032  
Phone: 206-854-0505

**Pasco**

Spokane Detroit Diesel Allison  
1810 E. James  
Pasco, WA 99301  
Phone: 509-547-1611

**Spokane**

Spokane Detroit Diesel Allison  
6615 E. Mallon Street  
(Zip 99212)  
P.O. Box 3167  
Terminal Annex  
Spokane, WA 99220  
Phone: 509-535-3663

**WEST VIRGINIA****South Charleston**

Western Branch Diesel, Inc.  
3100 MacCorkle Ave., SW  
P.O. Box 8245  
South Charleston, WV  
25303-8245  
Phone: 304-744-1511  
(24 Hr.)

**WISCONSIN****Butler**

Inland Diesel, Inc.  
13015 W. Custer Avenue  
(Milwaukee)  
P.O. Box 916  
Butler, WI 53007-0916  
Phone: 414-781-7100

**WYOMING****Casper**

Stewart & Associates  
Power, Inc.  
1850 East "F" Street  
Casper, WY 82601  
Phone: 307-234-6975

**Gillette**

Interstate Detroit Diesel, Inc.  
210 Limestone Avenue  
P.O. Box 1355  
Gillette, WY 82716  
Phone: 307-682-8596

**Rock Springs**

Smith Detroit Diesel -  
Allison, Inc.  
20 Bowker Road  
(Zip 82901)  
P.O. Box 1868  
Rock Springs, WY 82902  
Phone: 307-382-4330

**Authorized Blue Bird Coachworks  
Service Centers  
Chassis Service Only**

**Prèvost Car Inc., FL**

6391 Business Park Blvd.

N. Jacksonville, FL 32256

800-874-7740

904-886-4555

FAX: 904-886-0092 • Parts FAX: 904-886-0093

**Prèvost Car Inc., TN**

529 Hickory Hill Blvd.

Whites Creek, TN 37189

877-299-8881

615-299-8881

FAX: 615-299-8865

**Prèvost Car Inc., TX**

15200 Frye Road

Fort Worth, TX 76155

866-773-7678

817-685-0475

FAX: 817-685-0460

**Service Only**

**Holiday on Wheels, Inc.**

50 John Barrett Road

Patterson, NY 12563

800-416-0544 • 845-878-9400

FAX: 845-878-3647

**Miller's RV**

12912 Florida Blvd.

Baton Rouge, LA 70815

225-275-2940

FAX: 225-275-6807

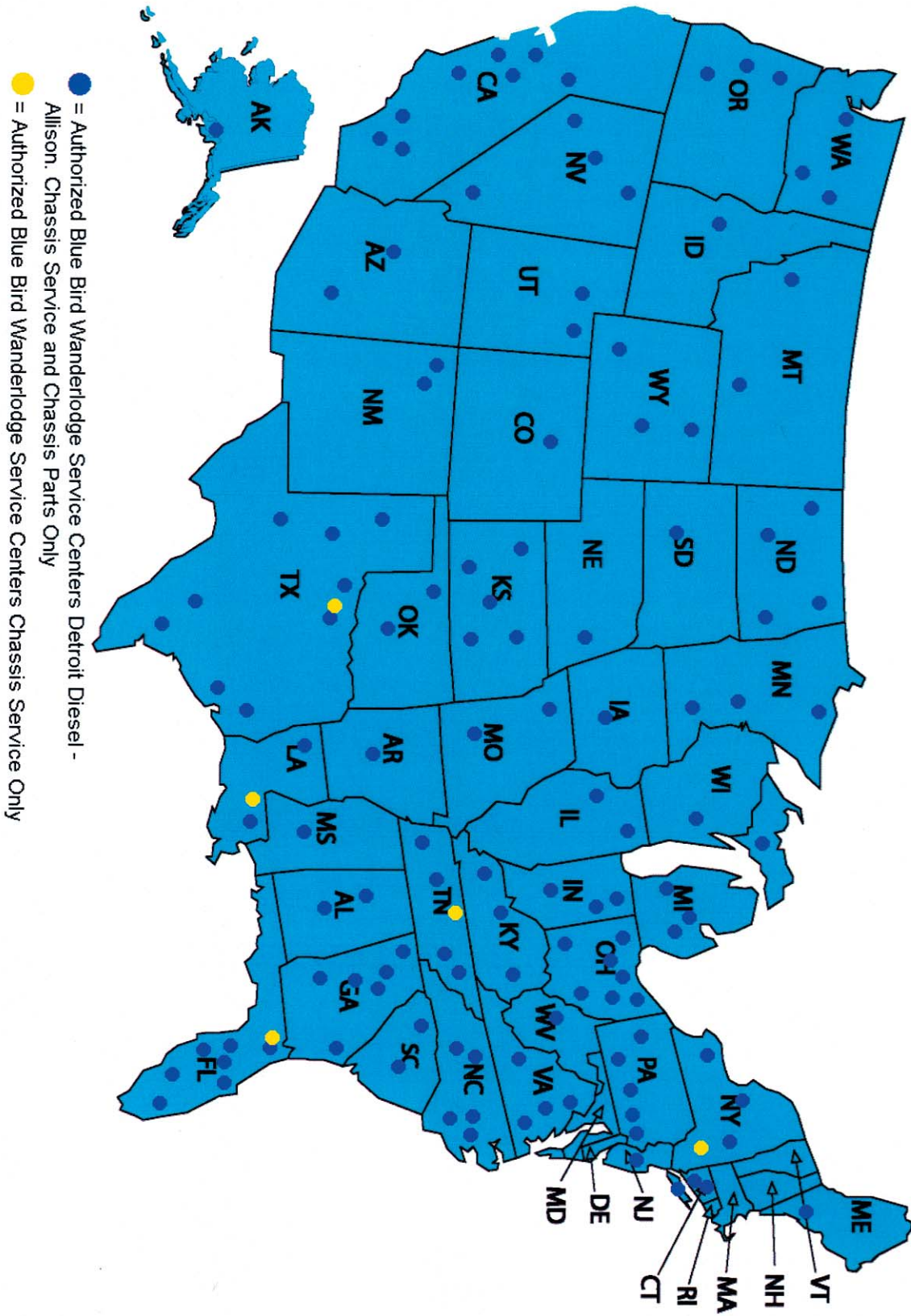



Wiring Schematic 0086776 - Index

TABLE OF CONTENTS  
H4RELXI 45 FEET  
SCHEMATIC DIAGRAMS INDEX

DESCRIPTION	SHEET	BB #	REV
INDEX	1	0086776	A
A ZONE	2	0076299	F
DASH	3	0076293	D
B-ZONE	4	0076452	A
FRAME	5	0076432	A
TOW PLUG HARNESS WRG	6	0084640	-
REAR PDU INTERFACE	7	0076577	A
D-ZONE	8	0082390	A
ENGINE,C13	9	0076434	A
FRONT,BODY	10	0086799	-
DATALINK	11	0076506	-
LIVING ROOM,BED ROOM,C/S	12	0075796	A
LIVING ROOM,BED ROOM,R/S	13	0100164	-
LR,DIN,SLIDE-OUT,BATH FLP A	14	0081856	-
LR,DIN,SLIDE-OUT,BATH FLP B	15	0086740	-
BAY,DC,LOAD CENTER	16	0076147	A
BAY,MULTIPLX	17	0076203	A
OVERHEAD PANEL,L/H GAUGES	18	0069318	-
SLIDE-OUT CONTROLLER,3-ROOM	19	0075037	B
EMS,LOAD CENTER,120V	20	0076352	-
AUXILIARY,120V,INVERTER	21	0080496	-
CABLE,POWER,DISTRIBUTIONN	22	0075825	D
DATALOOPS	23	0070060	-
FRONT,A/V	24	0075601	B
120VAC,POWER DISTRIBUTION,W/EMS,FPLA	25	0091200	B
POWER DISTRIBUTION,DC	26	0074465	-
REAR A/V	27	0075600	-
ONSTAR COMMUNICATION	28	0076919	-
LUGGAGE COMP 1	29	0078105	-
LUGGAGE COMP 2	30	0080226	-
LUGGAGE COMP 3	31	0081265	-
LUGGAGE COMP 4	32	0082266	-
LUGGAGE COMP 5	33	0084199	-
DASH,A/C CONTROLS	34	0086141	-
TAIL LIGHTS	35	0078072	-
BRAKE LIGHTS	36	0075992	-
TRANSMISSION	37	0102063	-
ENGINE COMPARTMENT LIGHTS	38	0086078	-
WEBASTO,HYDRONIC CONTROL SYSTEM	39	0086777	-
ENGINE,DASH,WEBASTO,HEATING SYSTEM	40	0086778	-
LR,KIT,SLIDE-OUT,BATH FLP A	41	0086762	-
LR,KIT,SLIDE-OUT,BATH FLP B	42	0086763	-
120VAC,POWER DISTRIBUTION,W/EMS,FPLB	43	0095819	-

DESCRIPTION	SHEET	BB #	REV
SCHEMATIC,WRG,LANDING LIGHTS	44	0089285	-
SCHEMATIC,WRG,GENERATOR SYS,120/240VAC	45	0089321	-
SCHEMATIC,WRG,ENG,DASH,WEB,HEATING,SYS	46	0089322	-
SCHEMATIC,WRG,DUAL,MOTOR,SYNCHRONIZER	47	0089536	-
SCHEMATIC,WRG,SLIDEOUT,PLC,CONTROLLER,4-ROOM	48	0089537	-
SCHEMATIC,WRG,DASH,SWITCH,PANELS	49	0098616	-
SCHEMATIC,PNEUMATIC,AIR LOCK VALVES,PSI SENSOR	50	0099998	-
SCHEMATIC,WRG,HYD,RFTOP A/C,ELEC,HT,CTL	51	0089289	B

CONTROL WIRE NUMBERING/COLOR CODE SYSTEM

COLOR	LAST DIGIT OF WIRE NUMBER
TAN	1
RED	2
ORANGE	3
YELLOW	4
GREEN	5
BLUE	6
PURPLE	7
GRAY	8
BLACK	9
PINK	0
WHITE	USED FOR ALL GROUNDS

FIRST SERIES OF THE LETTER = THE MULTIPLEX ZONE  
FIRST SERIES OF THE NUMBER = THE VOLTAGE AND PIN ASSIGNMENT OF THE CONNECTOR AT THE MODULE

A2-105

A2 = A ZONE  
A2 = A2 MODULE  
105 = (1 = 12 VOLTS) (05 = PIN#5 COLOR GREEN)

EXAMPLE: D2-214

D2 = D ZONE  
D2 = D2 MODULE  
214 = (2 = 24 VOLTS) (14 = PIN #14 COLOR YELLOW)

BLUE BIRD NON I/O CONTROL WIRE NUMBERING/COLOR CODE SYSTEM

24 VOLT WIRES ARE RED  
12 VOLT WIRES ARE ORANGE

EXAMPLE: 24VIGN10

24V = 24 VOLTS COLOR RED  
IGN = IGNITION  
10 = 10 GAUGE WIRE

EXAMPLE: 12VBATT12

12V = 12 VOLTS COLOR ORANGE  
BATT = BATTERY  
12 = 12 GAUGE WIRE

ALL OTHER WIRES THAT DO NOT FIT INTO THESE CATEGORIES WILL BE FUNCTION CODED

SCHEMATIC LEGEND

- X- SPRING RETURN (MOMENTARY ACTION)
- BC BATTERY COMPARTMENT
- BZ B ZONE
- CB CURB SIDE REAR BULKHEAD
- DH DRIVERS DASH PANEL
- DO DRIVER'S OVERHEAD PANEL
- DZ D ZONE
- EB ENGINE CONTROL BOX
- EC ENGINE COMPARTMENT
- FF FUEL FILL AREA
- FP FUSE PANEL
- MP MAIN ELECTRICAL PANEL
- RD REAR DOOR HEADER
- RP REAR POWER DISTRIBUTION CENTER
- SB STREET SIDE REAR BULKHEAD
- SC STEERING COLUMN
- SP SIDE SWITCH PANEL
- TB TERMINAL BLOCK
- TP TEST PORT PANEL
- (M) MOTOR
- (DH) CMP LOC eg. DRIVERS DASH PANEL

○ ○ ○ TWISTED PAIR WIRE

SCHEMATIC SYMBOLS

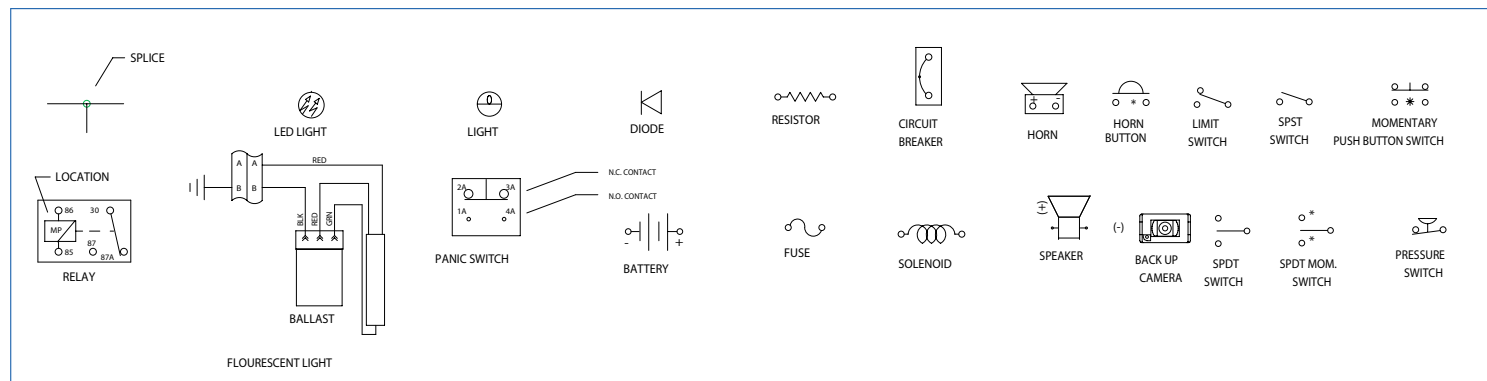

REV	DESCRIPTION	DATE	BY	CHKD
D	CHANGE TRANSMISSION SCHEMATIC NUMBER	11/11/18	SS	BT
C	CHANGE SCHEMATIC DRAWING NUMBER OR REV LEVEL	11/11/17	SS	BT
B	ADD NEW SCHEMATIC TO DRAWING	11/11/17	SS	BT
A	CHANGE PART NUMBER FOR 120V SCHEMATIC AND ADD PART NUMBER FOR 120V SCHEMATIC FLOOR B	11/11/16	SS	BT

DESIGN	WAG	REVISIONS	DR	APP	CHK
CN	131315	BLUE BIRD CORPORATION FORT VALLEY, GEORGIA, U.S.A.	SCALE	NONE	
SCHEMATIC,WRG,INDEX					
45H4RE					
DIR	01/03/05	BY	SS	D	0086776
APP	01/17/05	BY	BT		

**CONFIDENTIAL**  
The information herein is confidential. Business information and may not be copied or used for any purpose unless permission is expressly granted in writing by Blue Bird Body Company.  
Copyright 2002  
Blue Bird Body Company  
All rights reserved.

## Wiring Schematic 0076299 - A Zone

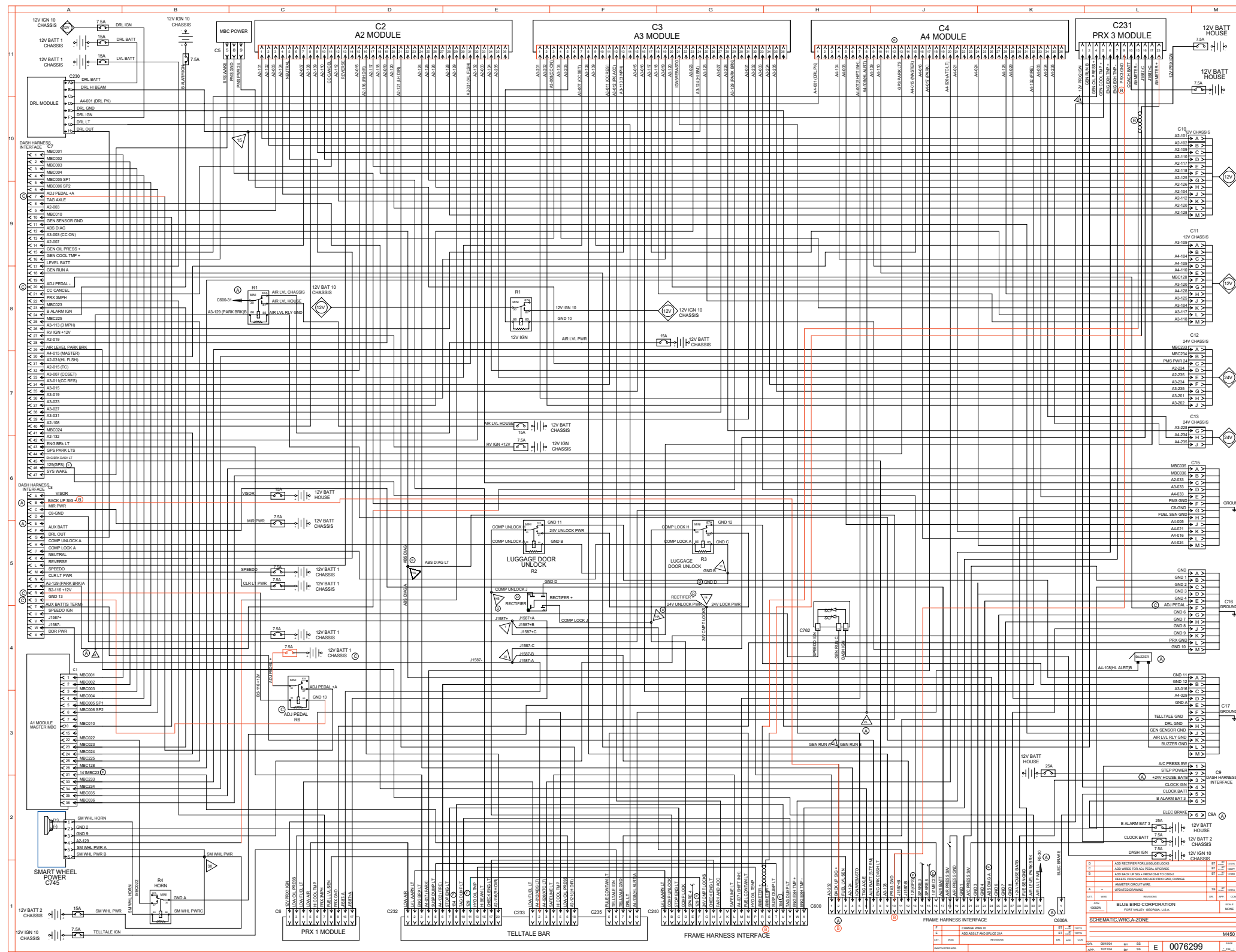



Wiring Schematic 0076299 - A Zone - Exploded View A

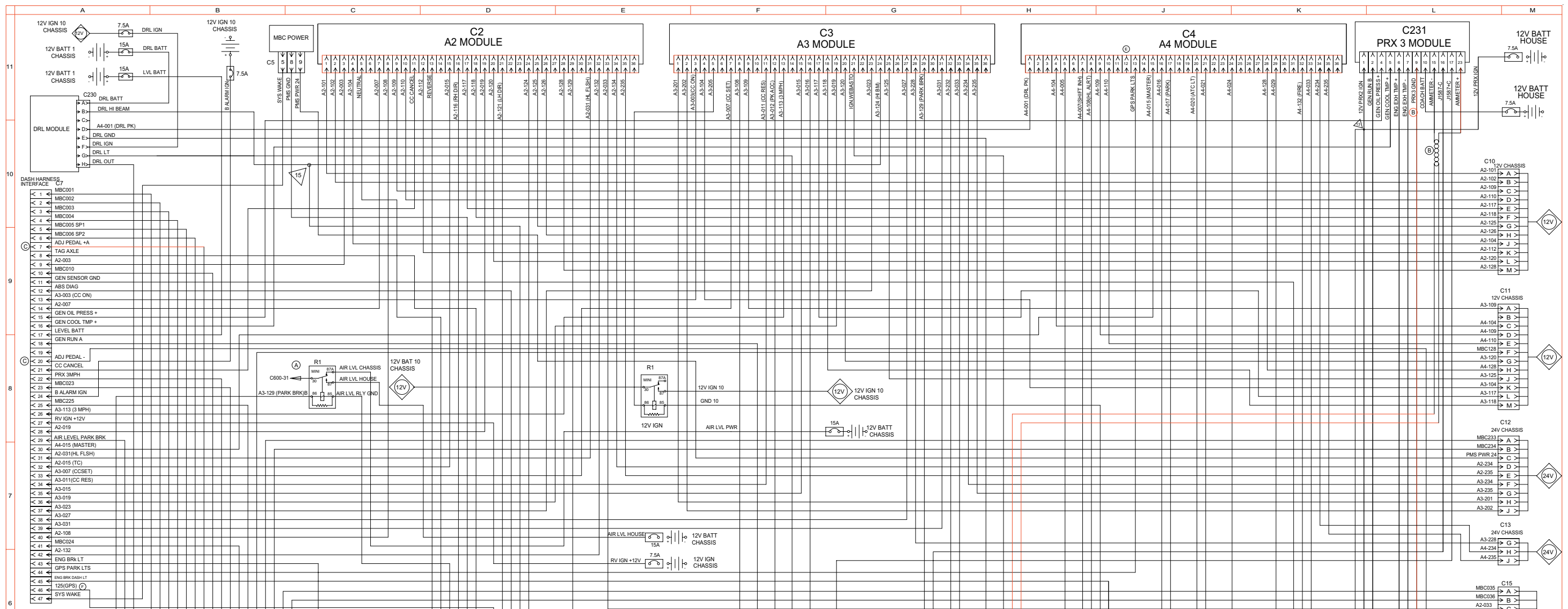

## Wiring Schematic 0076299 - A Zone - Exploded View B

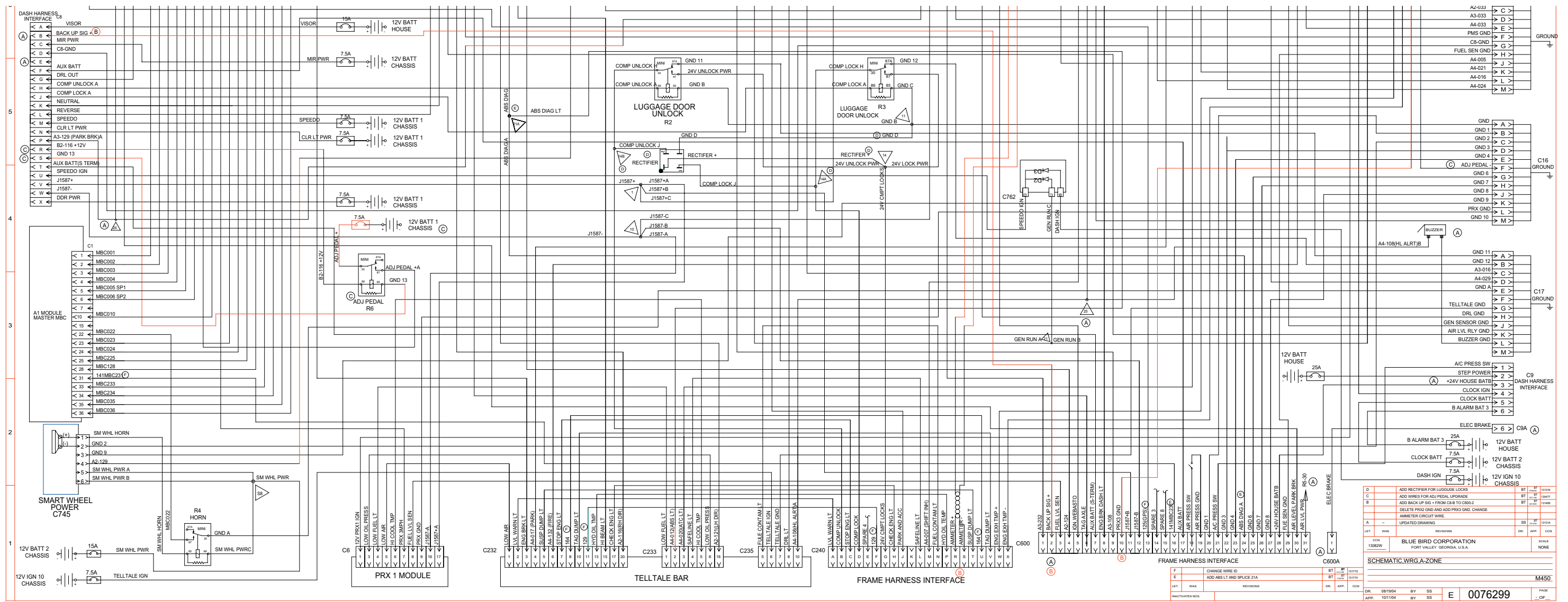

LET	WAS	REVISIONS	DR	APP	CON
D		ADD RECTIFIER FOR LUGGAGE LOCKS	BT	BT	10/0K
C		ADD WIRES FOR ADJ PEDAL UPGRADE	BT	BT	10/4T
B		ADD BACK UP SIG - FROM C88 TO C86/2	BT	BT	10/4E
A		DELETE PRX GND AND ADD PRX GND CHANGE			
		AMMETER CIRCUIT WIRE	SS	BT	10/3K
		UPDATED DRAWING			

  

F	CHANGE WIRE ID	BT	BT	00/7S	
E	ADD ABS LT AND SPLICE 2/A	BT	BT	01/7H	
LET	WAS	REVISIONS	DR	APP	CON

  

SCHEMATIC.WRG.A-ZONE					
BLUE BIRD CORPORATION					
FORT VALLEY, GEORGIA, U.S.A.					
SCALE: NONE					
SCHEMATIC.WRG.A-ZONE					
DRL	08/18/04	BY	SS		
APP	10/11/04	BY	SS	E	0076299
					PAGE
					_OF_

Wiring Schematic 0076293 - Dash

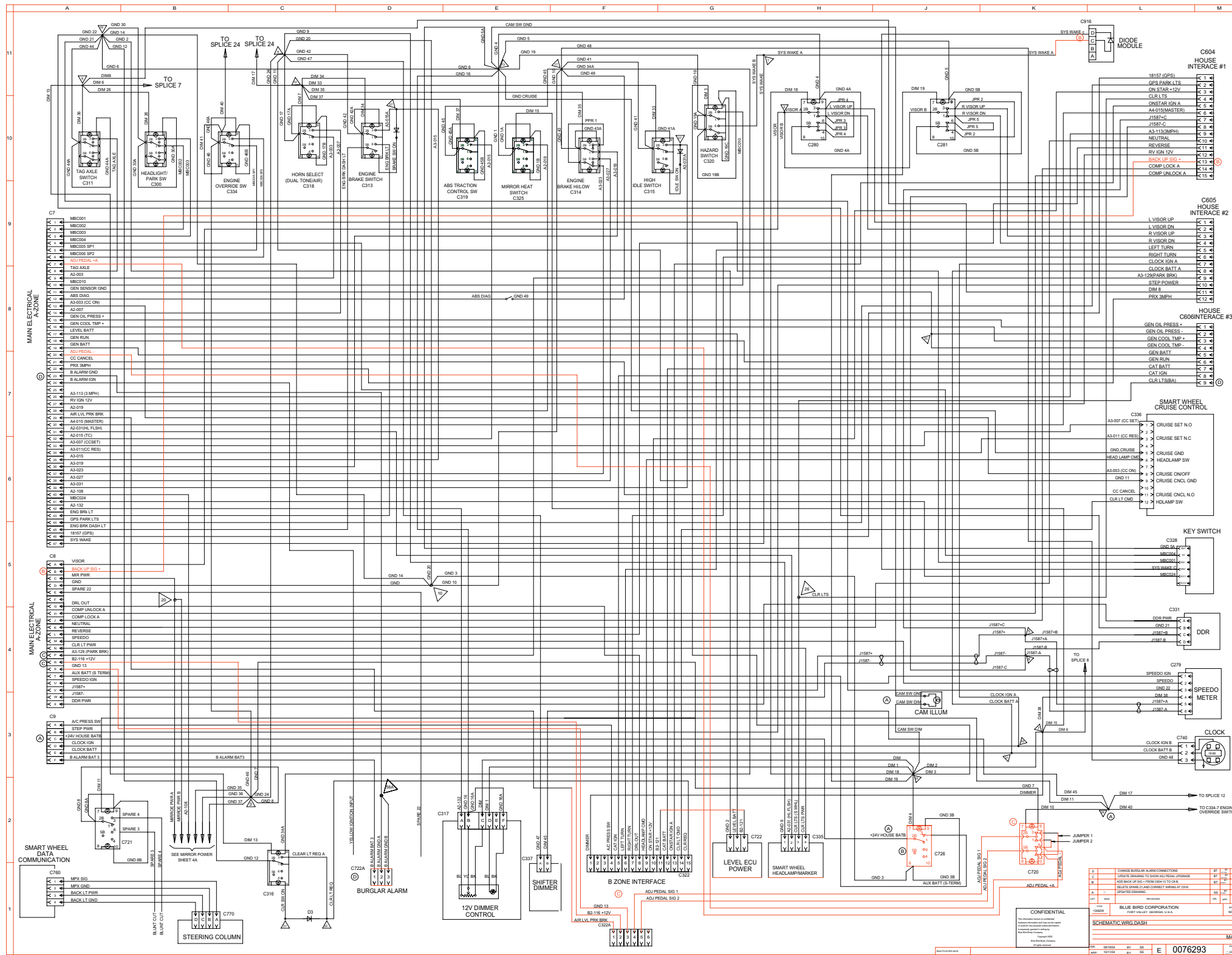

## Wiring Schematic 0076293 - Dash - Exploded View A

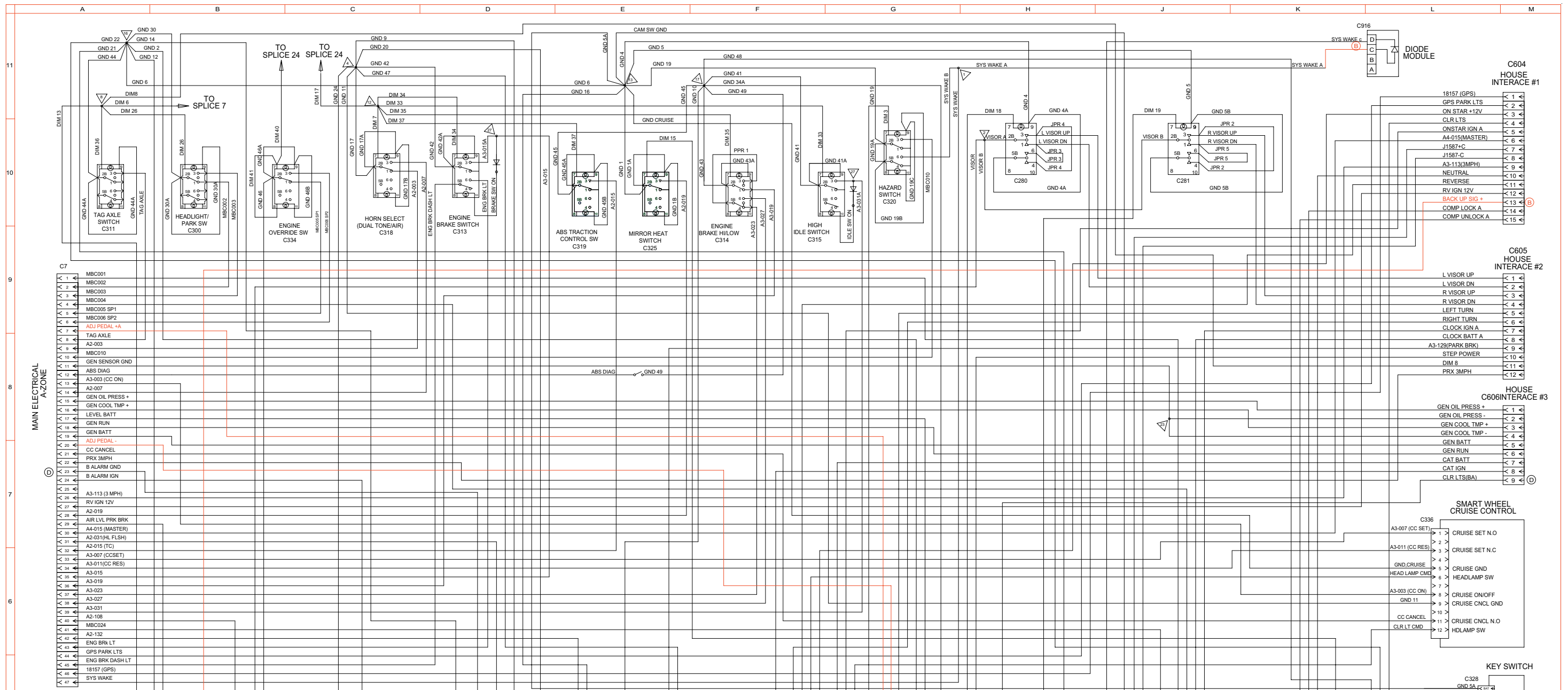

Wiring Schematic 0076293 - Dash - Exploded View B

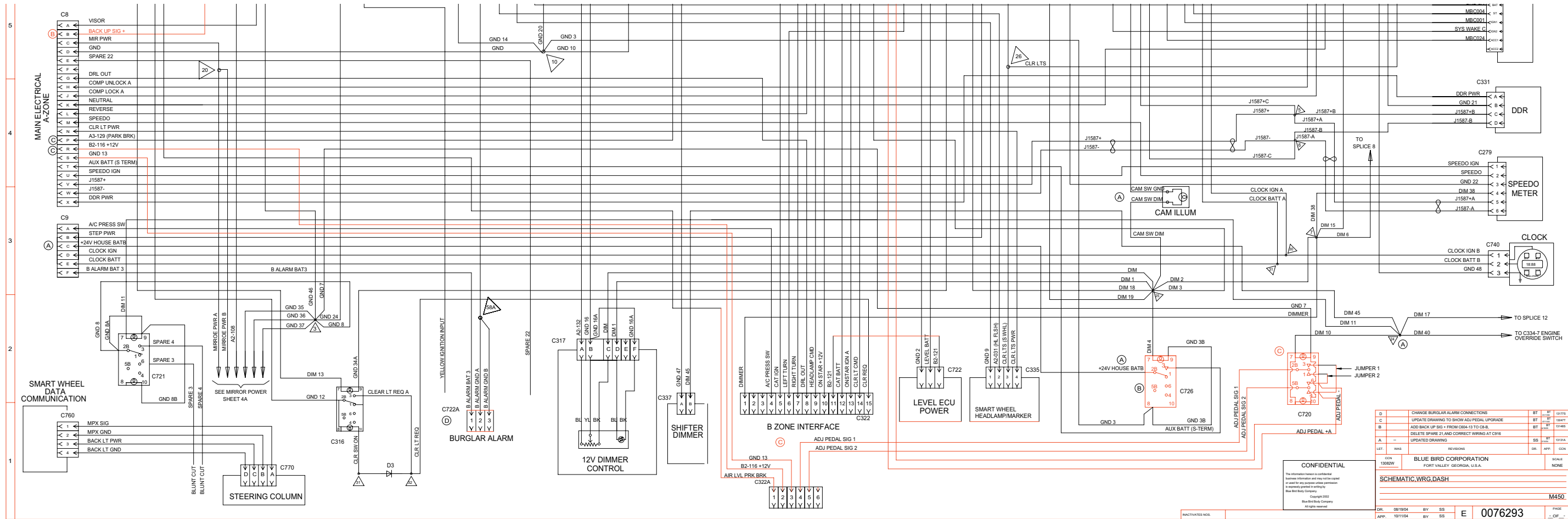

REV	DESCRIPTION	DATE	BY	CHKD
D	CHANGE BURGLAR ALARM CONNECTIONS	BT	BT	10/17/15
C	UPDATE DRAWING TO SHOW ADJ PEDAL UPGRADE	BT	BT	10/07/15
B	ADD BACK UP SIG + FROM C334 TO C316	BT	BT	10/06/15
A	DELETE SPARE 21 AND CORRECT WIRING AT C316	SS	BT	10/15/14
-	UPDATED DRAWING	SS	BT	10/15/14

  

CCN	BLUE BIRD CORPORATION	SCALE	NONE
13052W	FORT VALLEY, GEORGIA, U.S.A.		
SCHEMATIC.WRG.DASH			
M450			
DR	05/15/04	BY	SS
APP	10/11/04	BY	SS
			PAGE
			E 0076293
			- OF -

## Wiring Schematic 0076452 - B-Zone

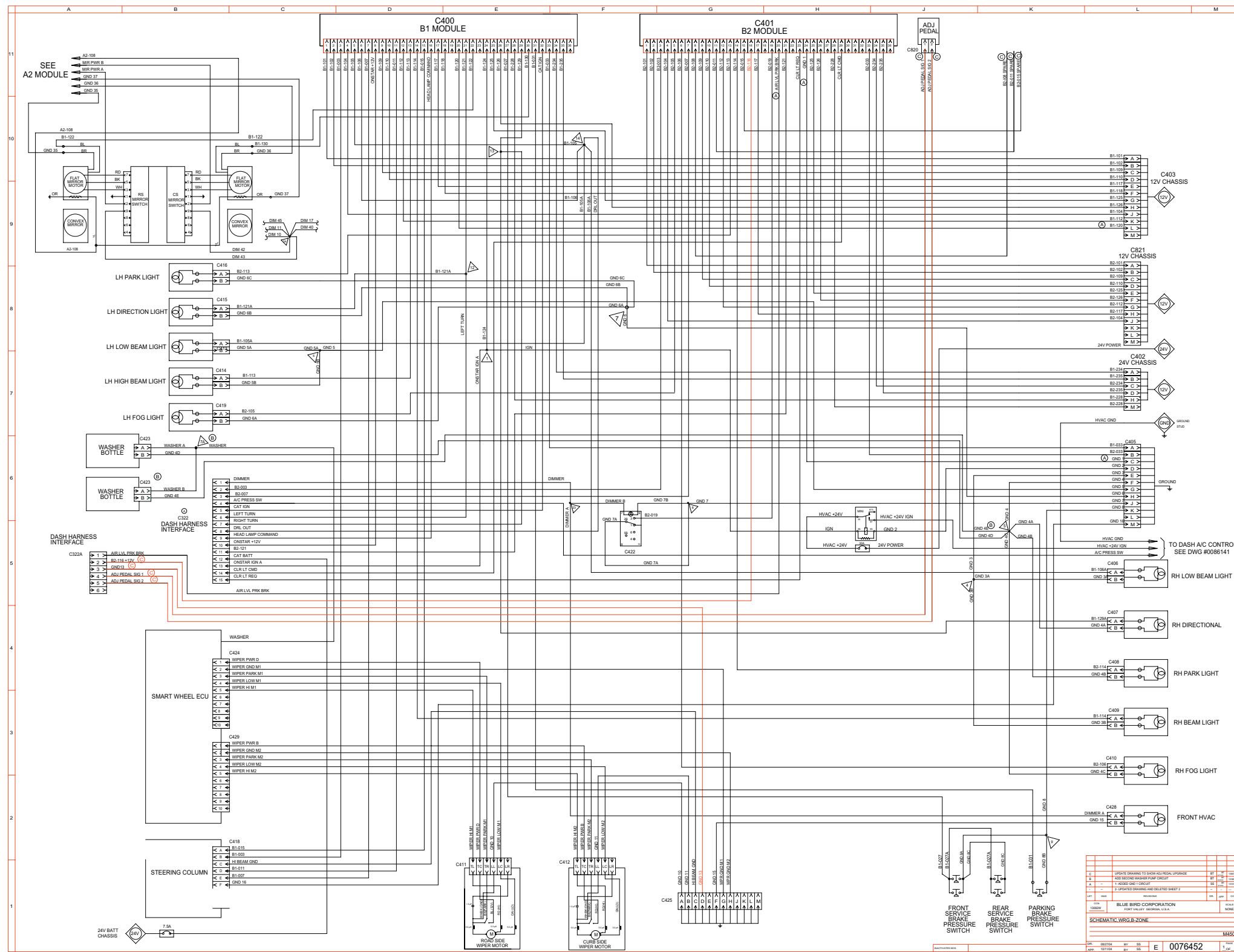

Wiring Schematic 0076452 - B-Zone - Exploded View A

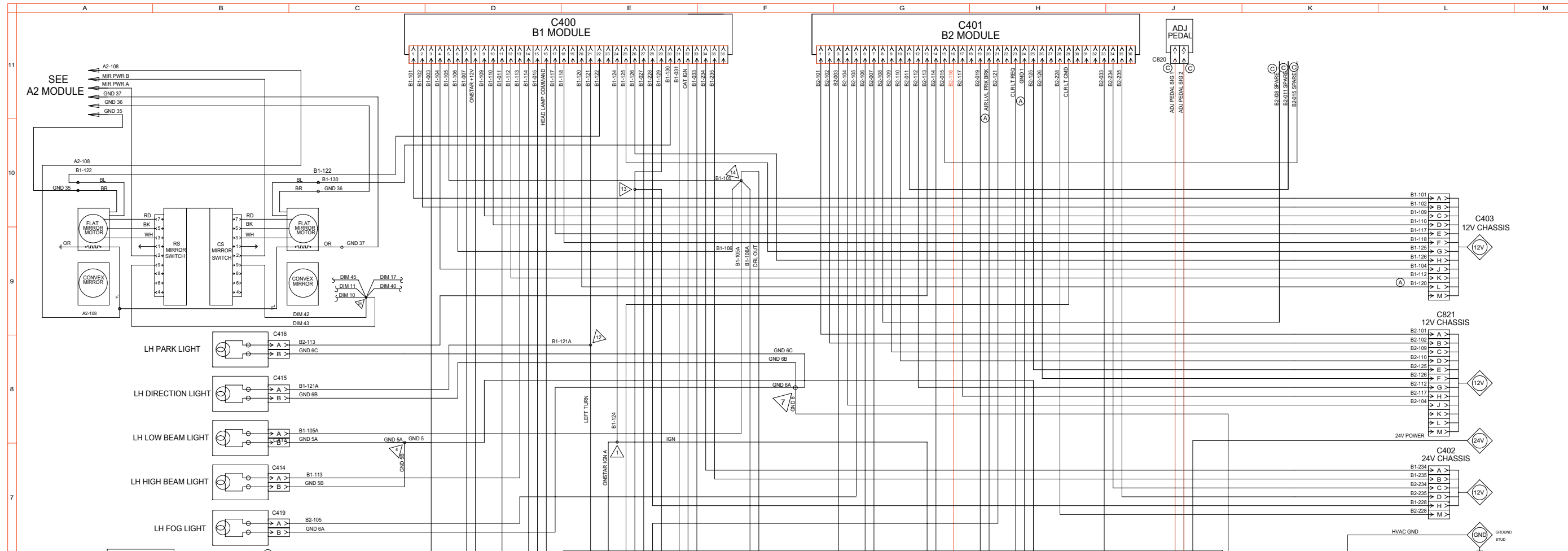

## Wiring Schematic 0076452 - B-Zone - Exploded View B

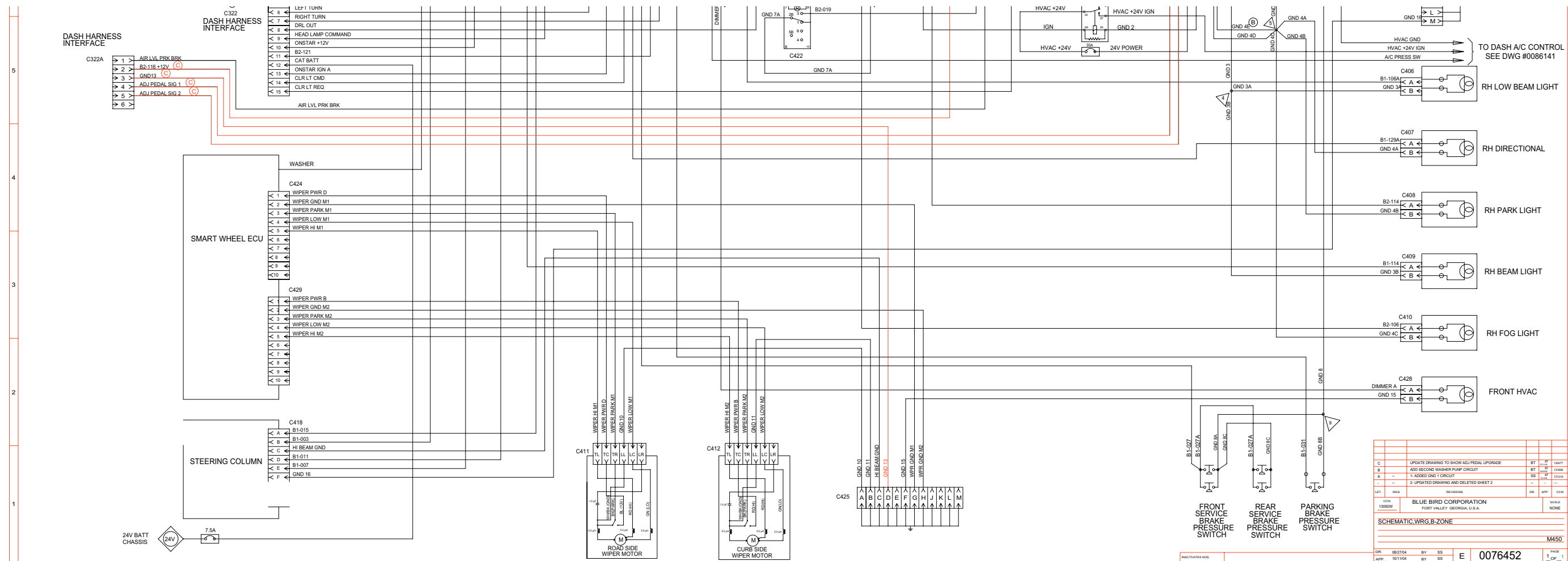

REV	DESCRIPTION	DATE	BY	CHKD
C	UPDATE DRAWING TO SHOW ADJ PEDAL UPGRADE	01/01/07	SS	SS
B	ADD SECOND WASHER PUMP CIRCUIT	01/01/04	SS	SS
A	1-ADDED GND 1 CIRCUIT	01/01/04	SS	SS
-	2-UPDATED DRAWING AND DELETED SHEET 2	-	-	-
LET	ISSUED	REVISIONS	DR	APP
COE 13802W BLUE BIRD CORPORATION FORT VALLEY, GEORGIA, U.S.A. SCALE NONE M450				
SCHEMATIC.WRG.B-ZONE				
DR	08/27/04	BY	SS	
APP	10/11/04	BY	SS	
E 0076452				PAGE 1 OF 1



Wiring Schematic 0076432 - Frame

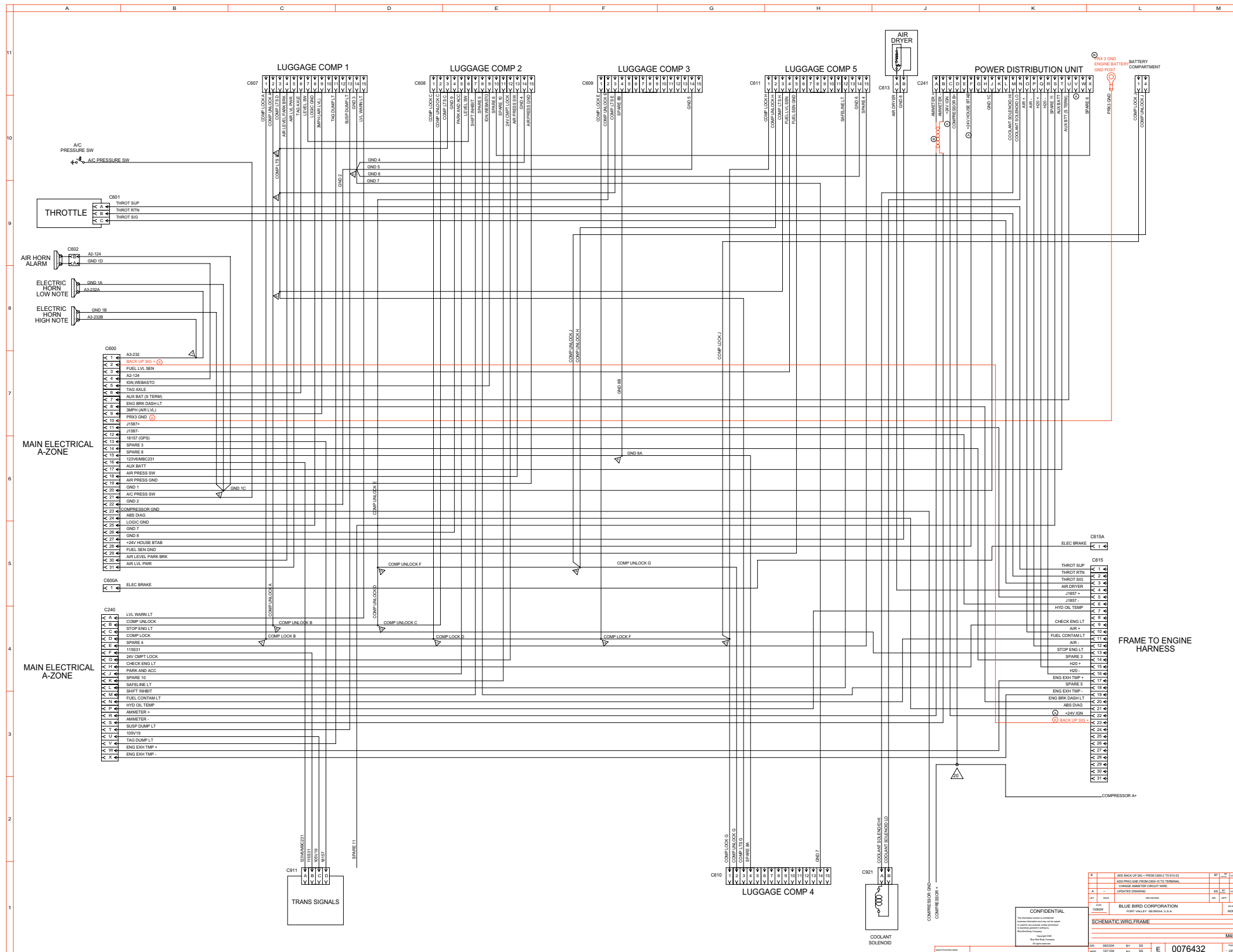

## Wiring Schematic 0076432 - Frame - Exploded View A

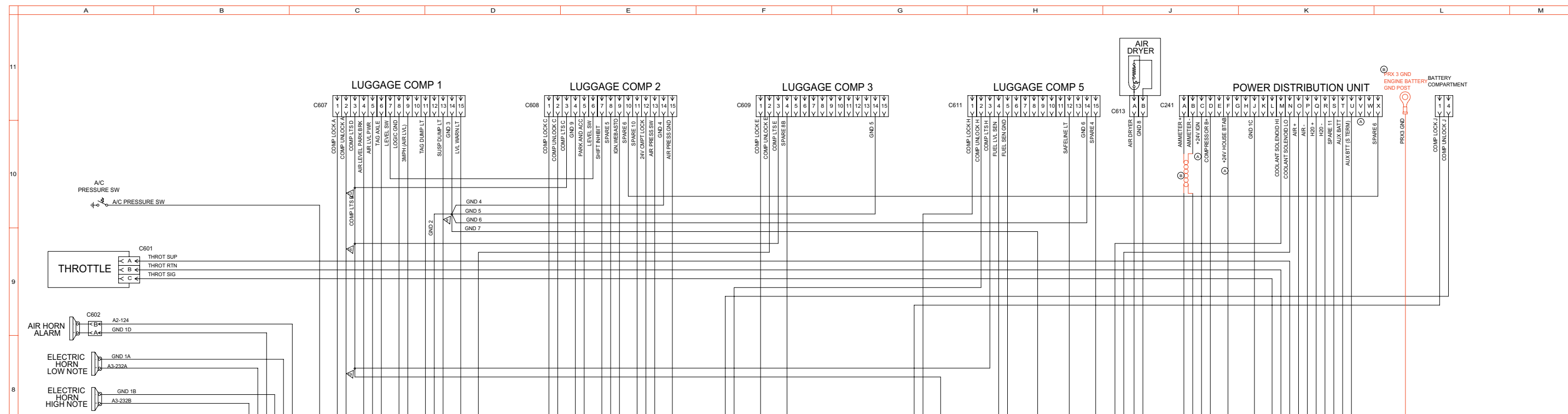

Wiring Schematic 0076432 - Frame - **Exploded View B**

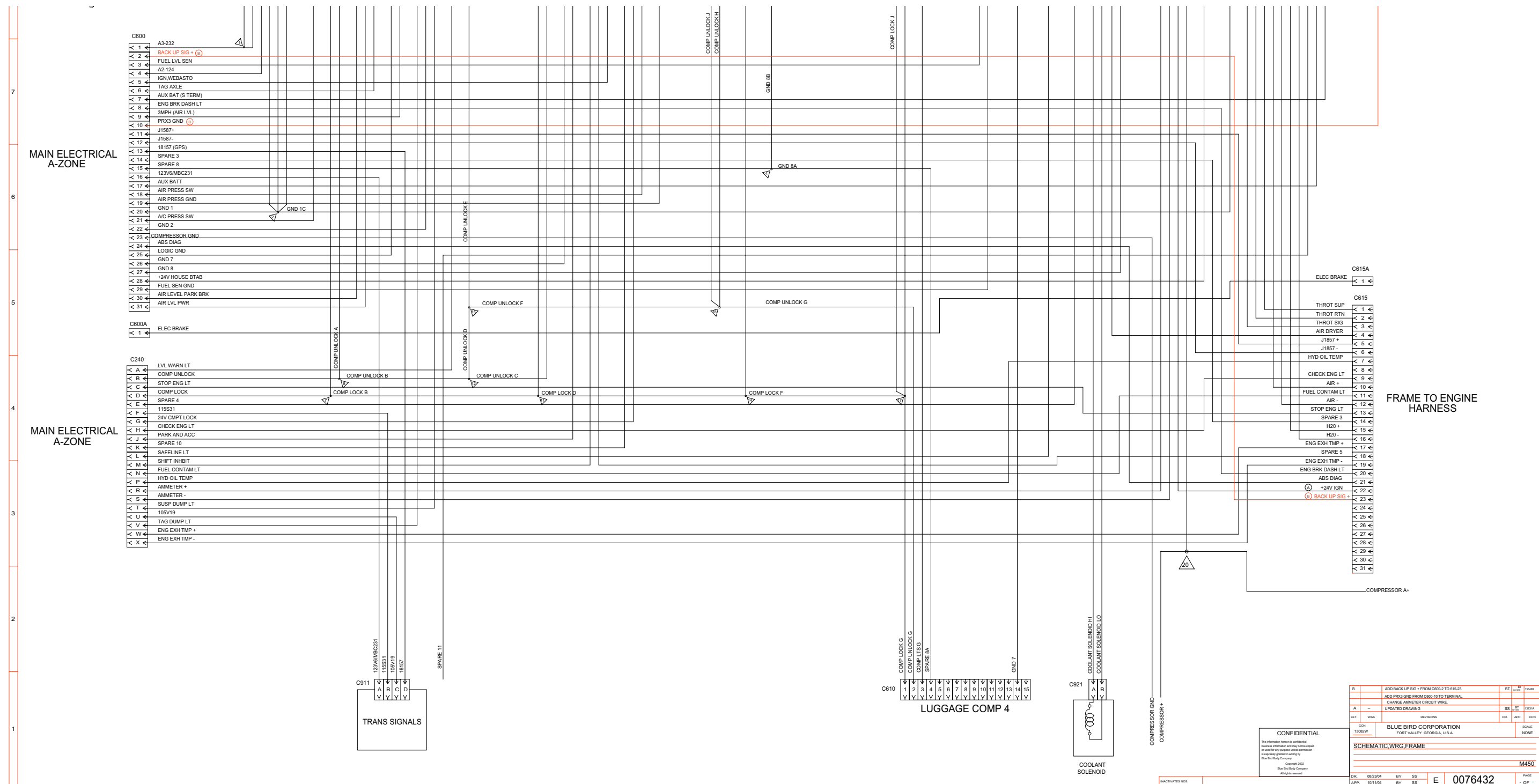

## Wiring Schematic 0084640 - Tow Plug Harness Wrg

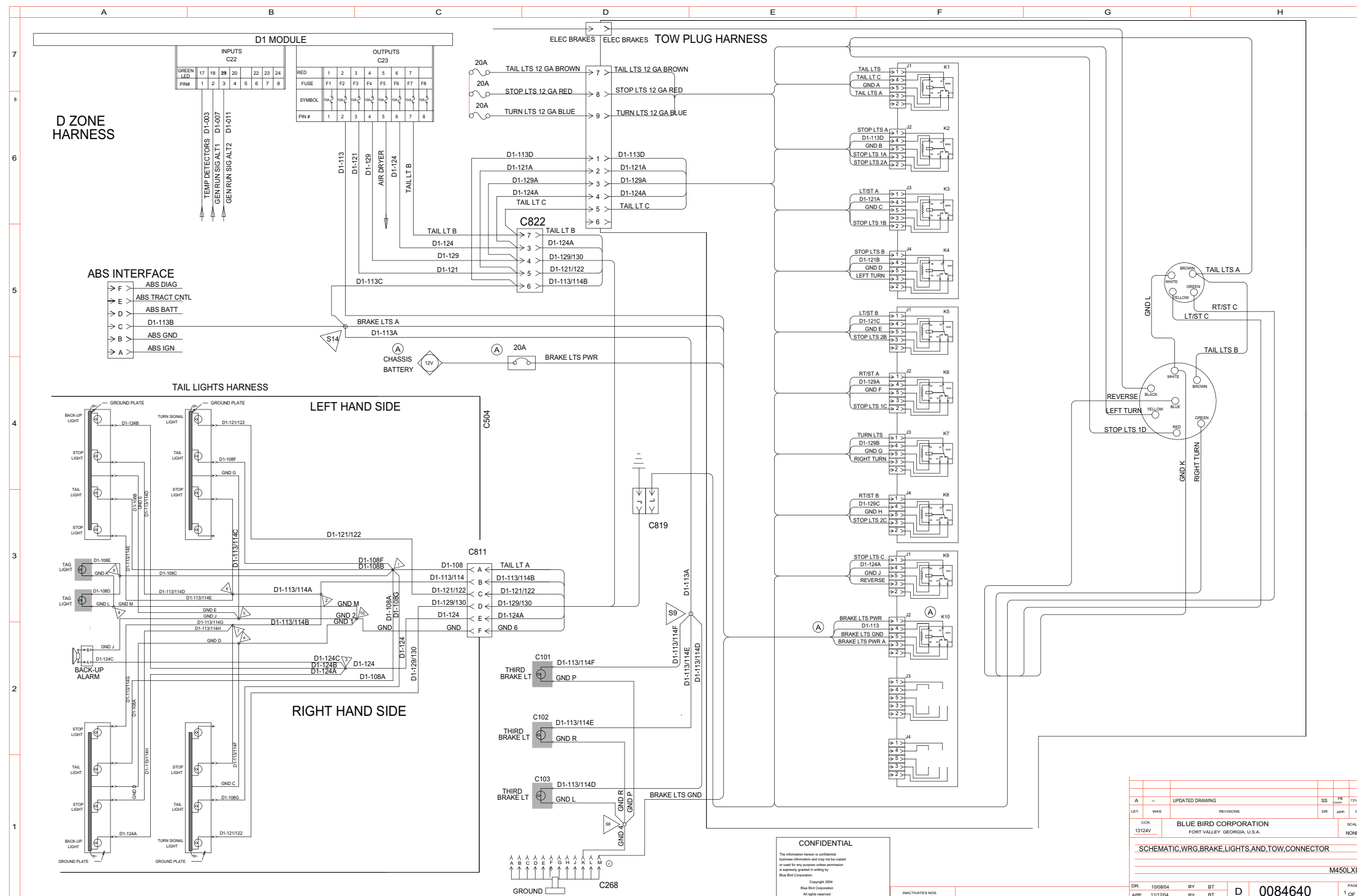

REV	DESCRIPTION	DATE	BY	CHKD
A	UPDATED DRAWING		SS	MS
LET	WAS		DR	APP
CON	13124V			CON
BLUE BIRD CORPORATION FORT VALLEY, GEORGIA, U.S.A.				
SCHEMATIC, WRG, BRAKE LIGHTS AND TOW CONNECTOR				
M450LXI				
DR	10/08/04	BY	BT	
APP	11/12/04	BY	BT	
D 0084640				PAGE 1 OF 1

**CONFIDENTIAL**

The information herein is confidential business information and may not be copied or used in any program unless permission is expressly granted in writing by Blue Bird Corporation.

Copyright 2004  
Blue Bird Corporation  
All rights reserved.

Wiring Schematic 0084640 - Tow Plug Harness Wrg - Exploded View A

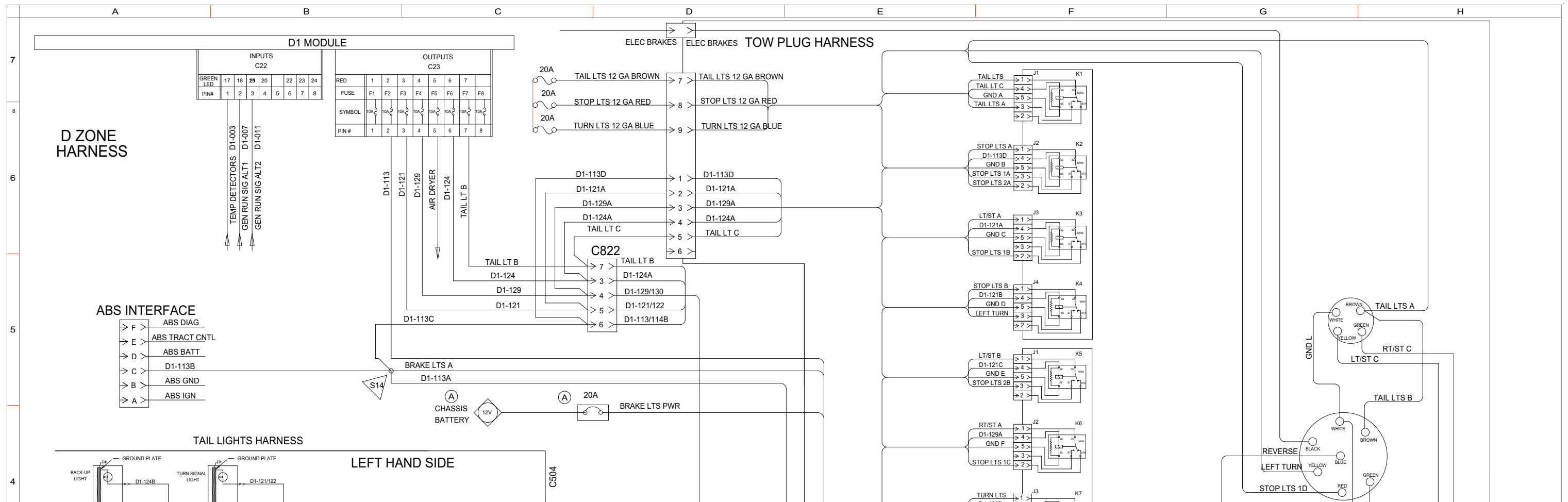

## Wiring Schematic 0084640 - Tow Plug Harness Wrg - Exploded View B

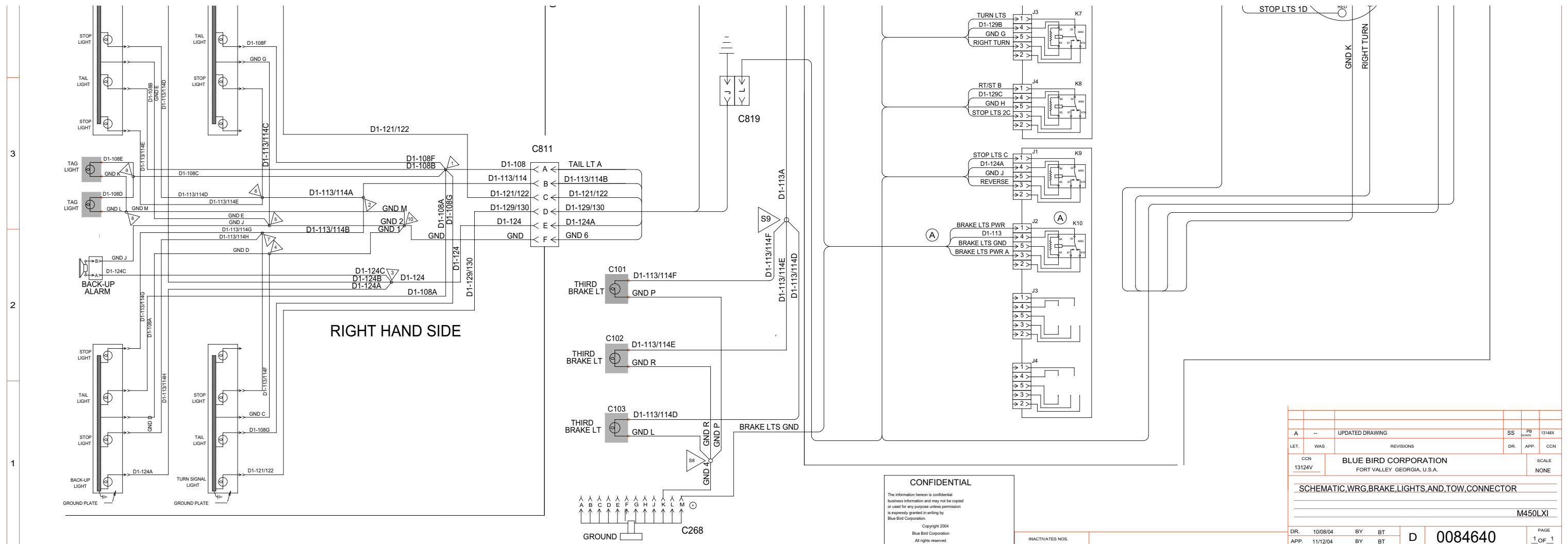

CCN	13124V	BLUE BIRD CORPORATION	FORT VALLEY, GEORGIA, U.S.A.	SCALE	NONE
SCHEMATIC, WRG, BRAKE, LIGHTS, AND, TOW, CONNECTOR					
M450LXI					
DR.	10/08/04	BY	BT	D	0084640
APP.	11/12/04	BY	BT		PAGE 1 OF 1

Wiring Schematic 0076577 - Rear PDU Interface

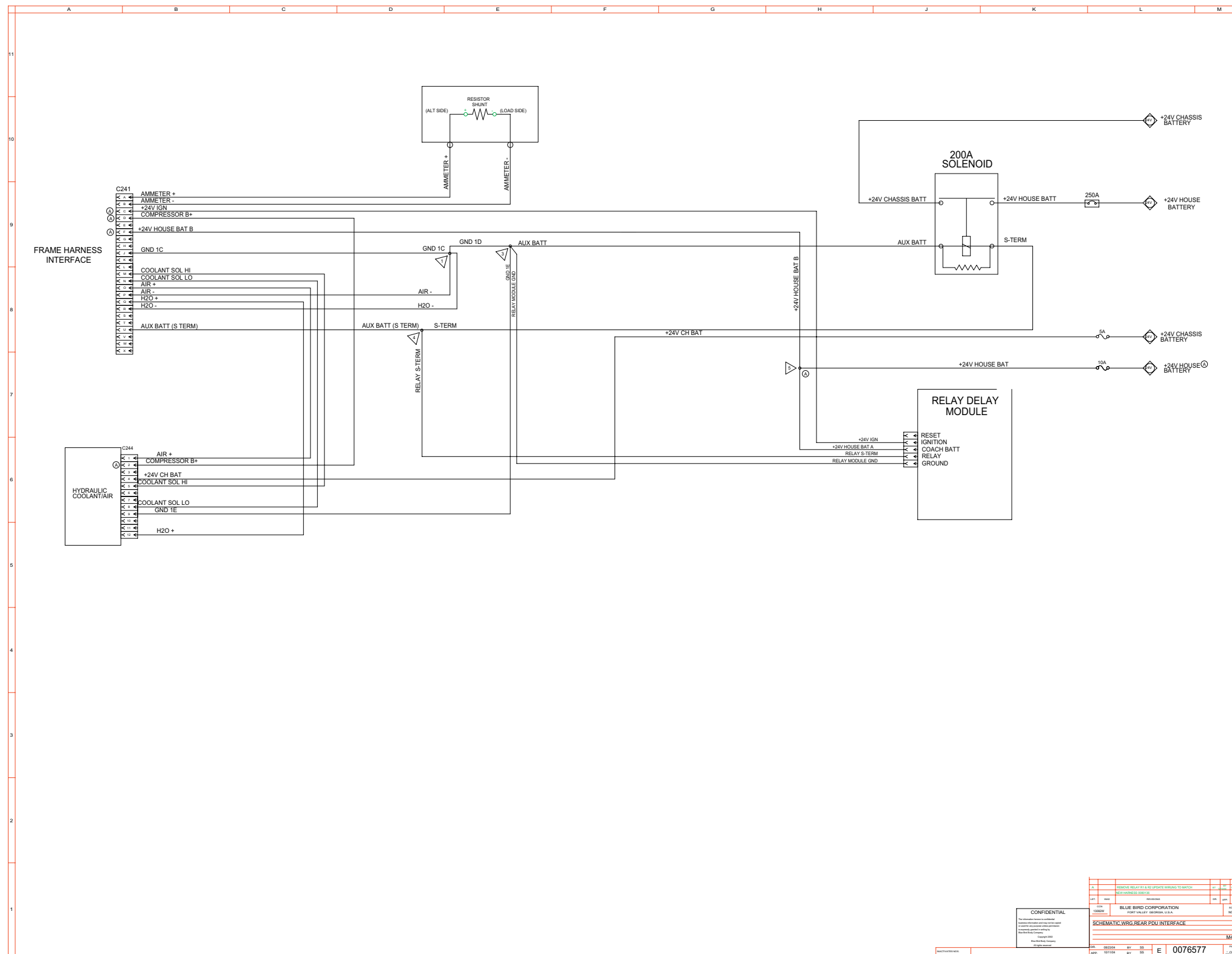

CONFIDENTIAL	
DATE	BY
08/08/08	EV
APP	10/11/08
REV	02
0076577	

## Wiring Schematic 0082390 - D-Zone

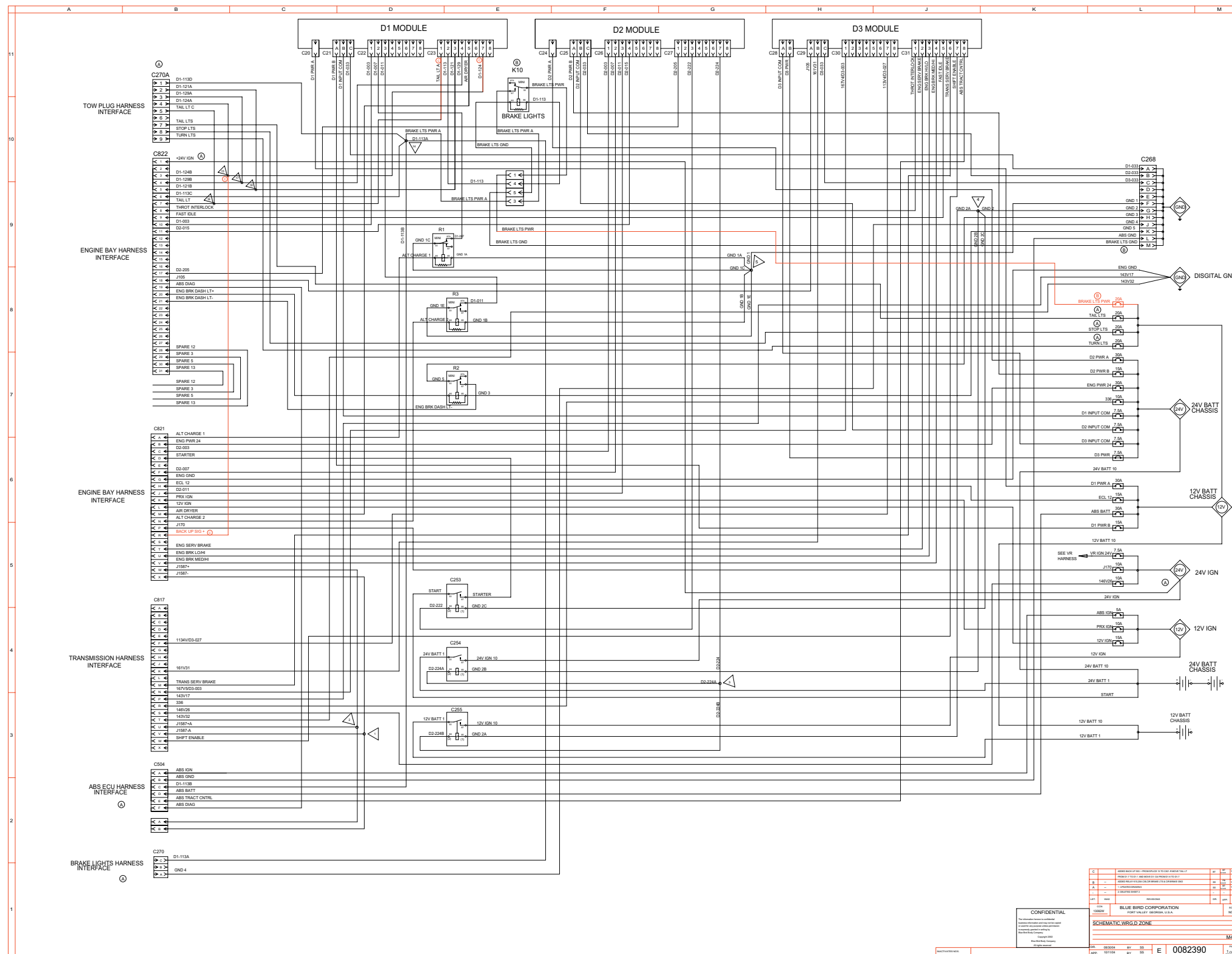

REV	DESCRIPTION	DATE	BY	CHKD
1	ISSUED FOR PRODUCTION	08/11/08	EV	MS
2	REVISION TO 11-18-18	08/11/08	EV	MS
3	REVISION TO 11-18-18	08/11/08	EV	MS
4	REVISION TO 11-18-18	08/11/08	EV	MS
5	REVISION TO 11-18-18	08/11/08	EV	MS
6	REVISION TO 11-18-18	08/11/08	EV	MS
7	REVISION TO 11-18-18	08/11/08	EV	MS
8	REVISION TO 11-18-18	08/11/08	EV	MS
9	REVISION TO 11-18-18	08/11/08	EV	MS
10	REVISION TO 11-18-18	08/11/08	EV	MS

CONFIDENTIAL

BLUE BIRD CORPORATION  
FORT VALLEY, GEORGIA, U.S.A.

SCHEMATIC, WIRING ZONE

MS02

0082390



Wiring Schematic 0082390 - D-Zone - Exploded View A

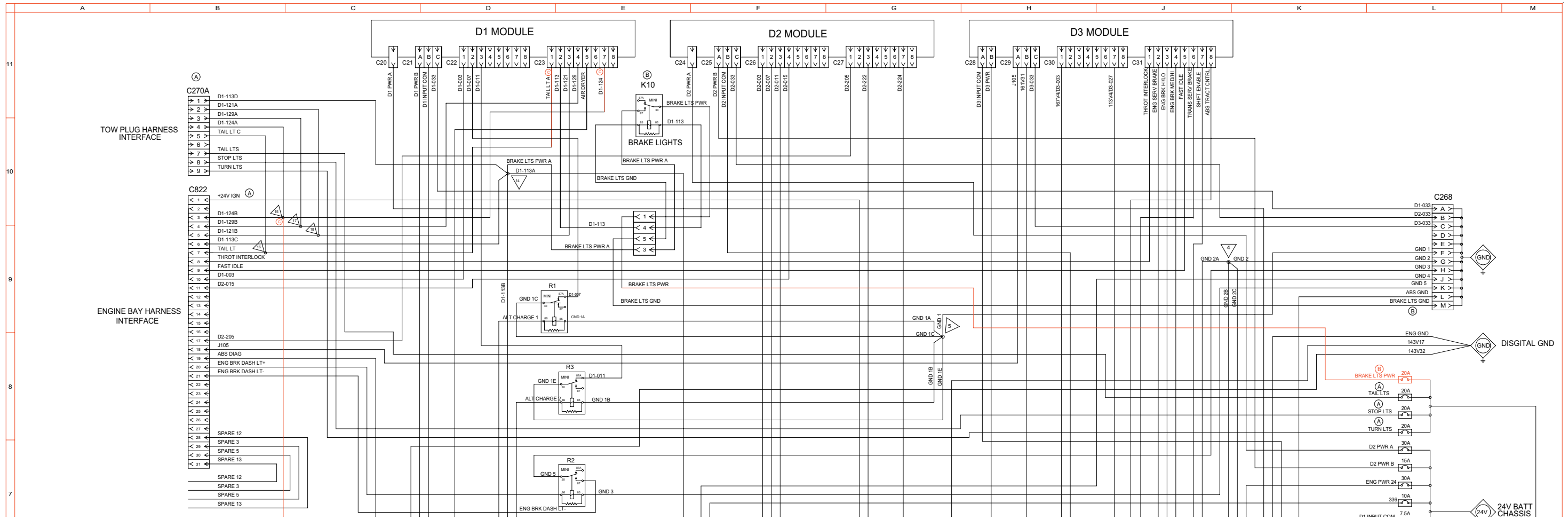

## Wiring Schematic 0082390 - D-Zone - Exploded View B

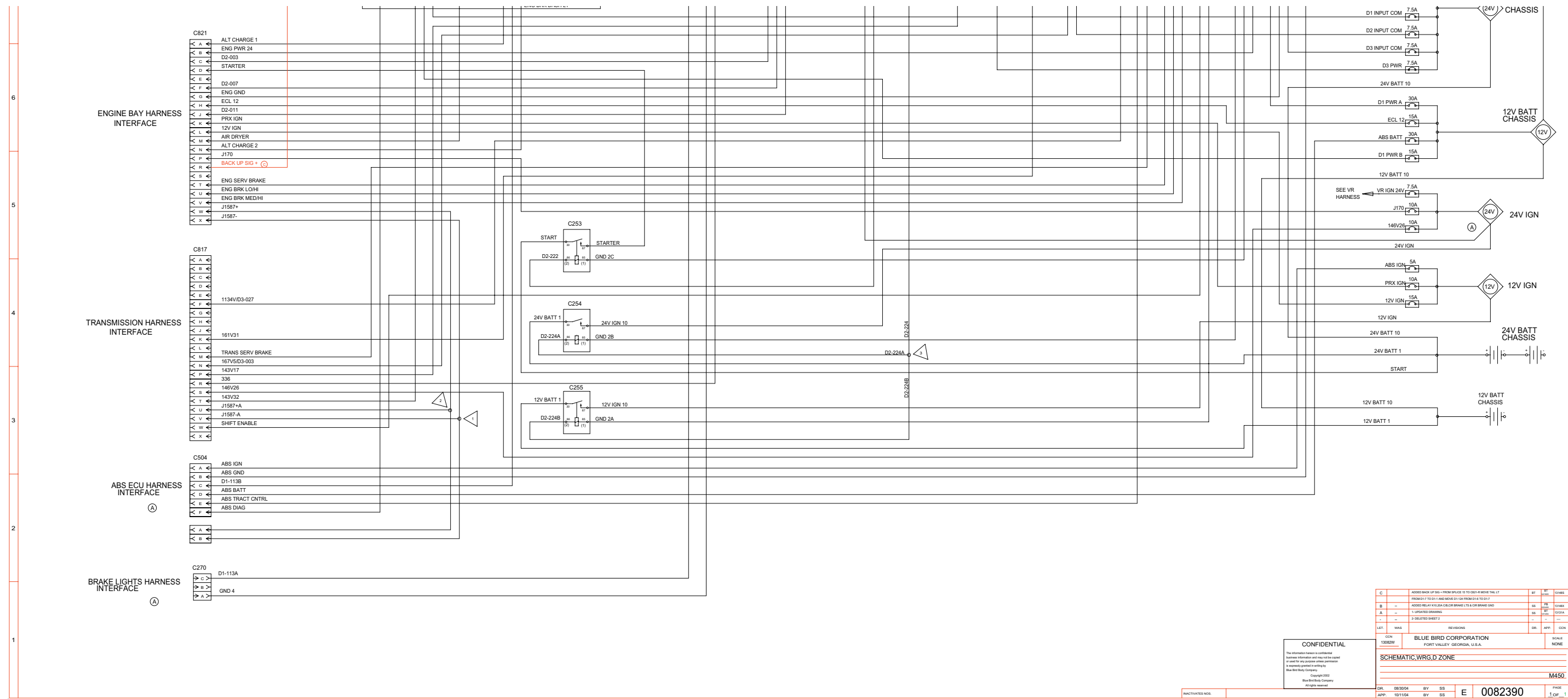

C	ADDED BACK UP SIG - FROM SERVICE TO D2-224 B MOVE THE LT	BT	SS	CHMS
B	FROM D17 TO D14 AND MOVE D1-13A FROM D14 TO D17	SS	SS	CHMS
A	ADDED RELAY W/1.25A COIL FOR BRAKE LIT & CIR BRAKE GND	SS	BT	CHMS
1	1-UPGRADED BRASSING	SS	BT	CHMS
2	2-DELETED SHEET 2	-	-	-
LET	WAS	REVISIONS	DEL	APP
CCN	13082W	BLUE BIRD CORPORATION	SCALE	NONE
		FORT VALLEY, GEORGIA, U.S.A.		
SCHEMATIC.WRG.D ZONE				
M450				
DR	08/30/04	BY	SS	
APP	10/11/04	BY	SS	
E 0082390				PAGE 1 OF 1

Wiring Schematic 0076434 - Engine, C13

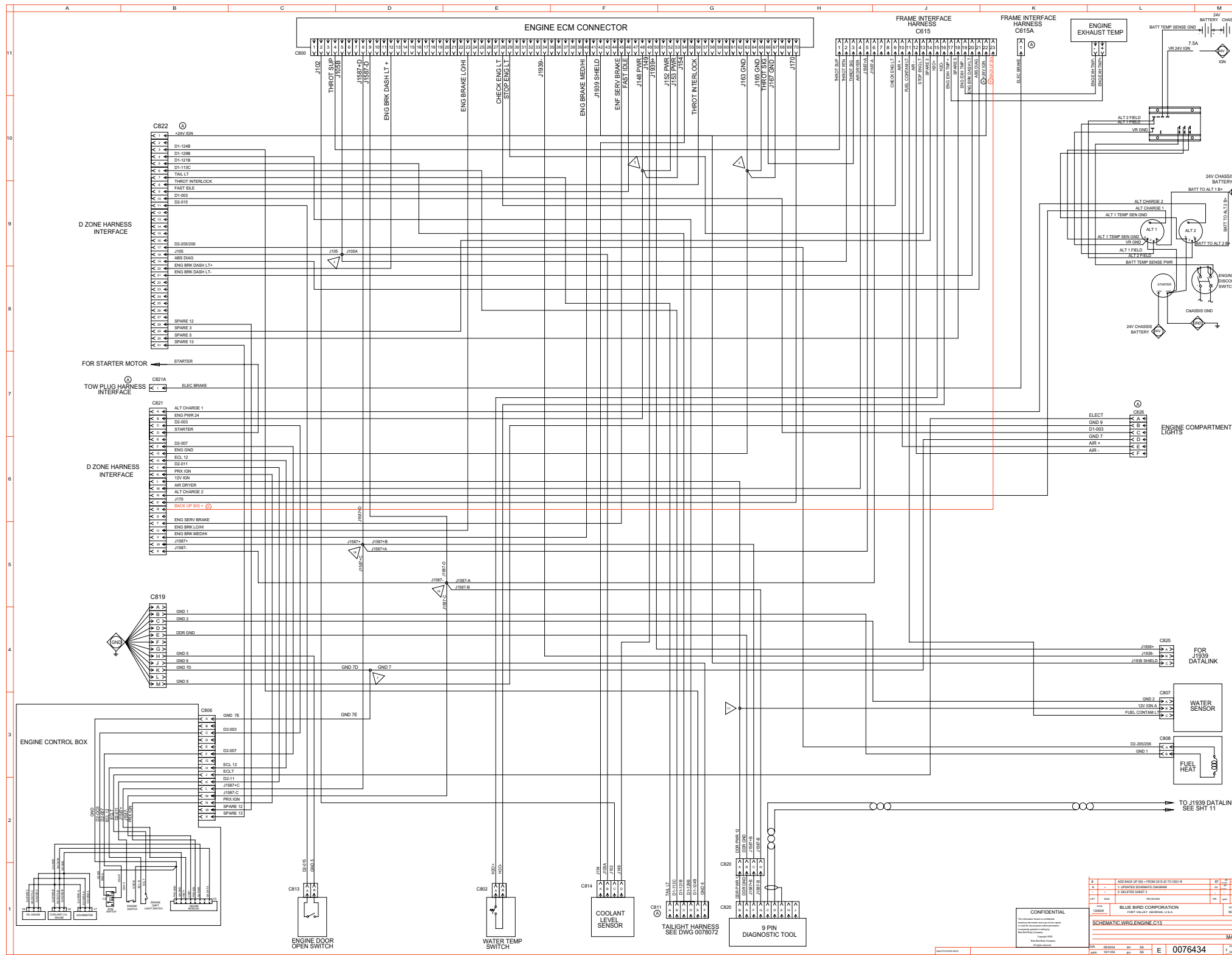

## Wiring Schematic 0076434 - Engine, C13 - Exploded View A

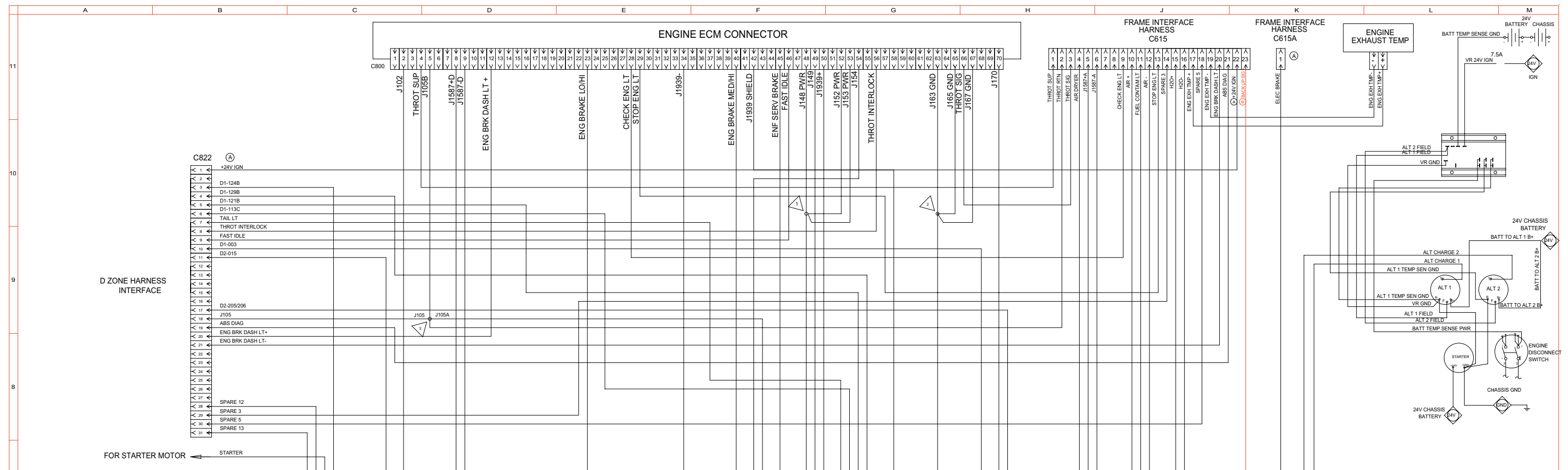

Wiring Schematic 0076434 - Engine, C13 - Exploded View B

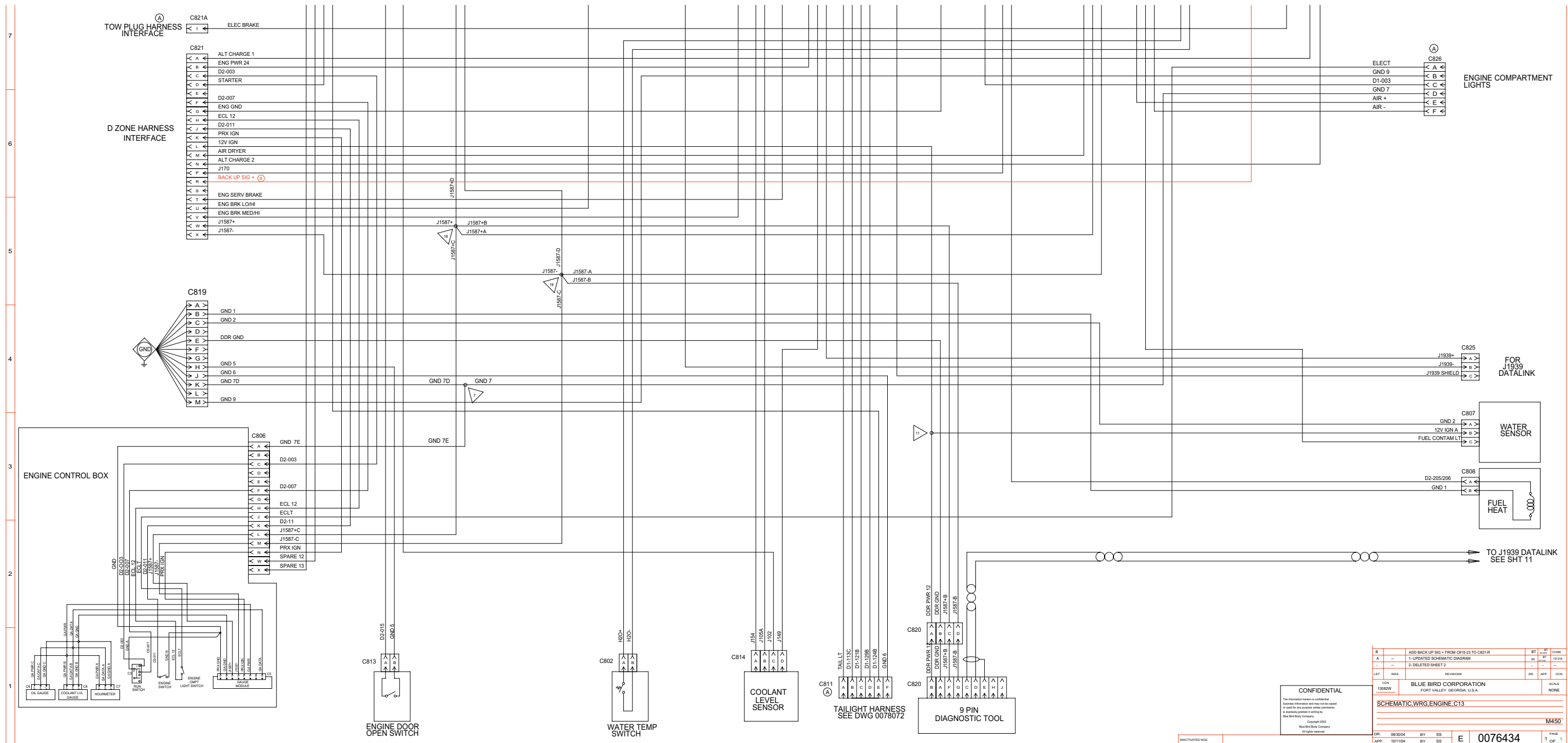

B	ADD BACK UP SIG + FROM C815-23 TO C821A	BT	BT	04/95	
A	1. UPDATED SCHEMATIC DIAGRAM	SS	SS	03/94	
-	2. DELETED SHEET 2	-	-	-	
REV	DATE	REVISIONS	DR	APP	CCN
CCN	13082W	BLUE BIRD CORPORATION FORT VALLEY, GEORGIA, U.S.A.			SCALE NONE
SCHEMATIC.WRG.ENGINE.C13					
M450					
DR	08/20/04	BY	SS	E	0076434
APP	10/11/04	BY	SS		PAGE 1 OF 1

**CONFIDENTIAL**  
 This information is confidential. It is not to be distributed or used for any purpose other than that for which it was originally intended without the express written permission of Blue Bird Body Company.  
 Copyright © 2004 Blue Bird Body Company  
 All rights reserved.

Wiring Schematic 0086799 - Front, Body\_Page 1 of 2

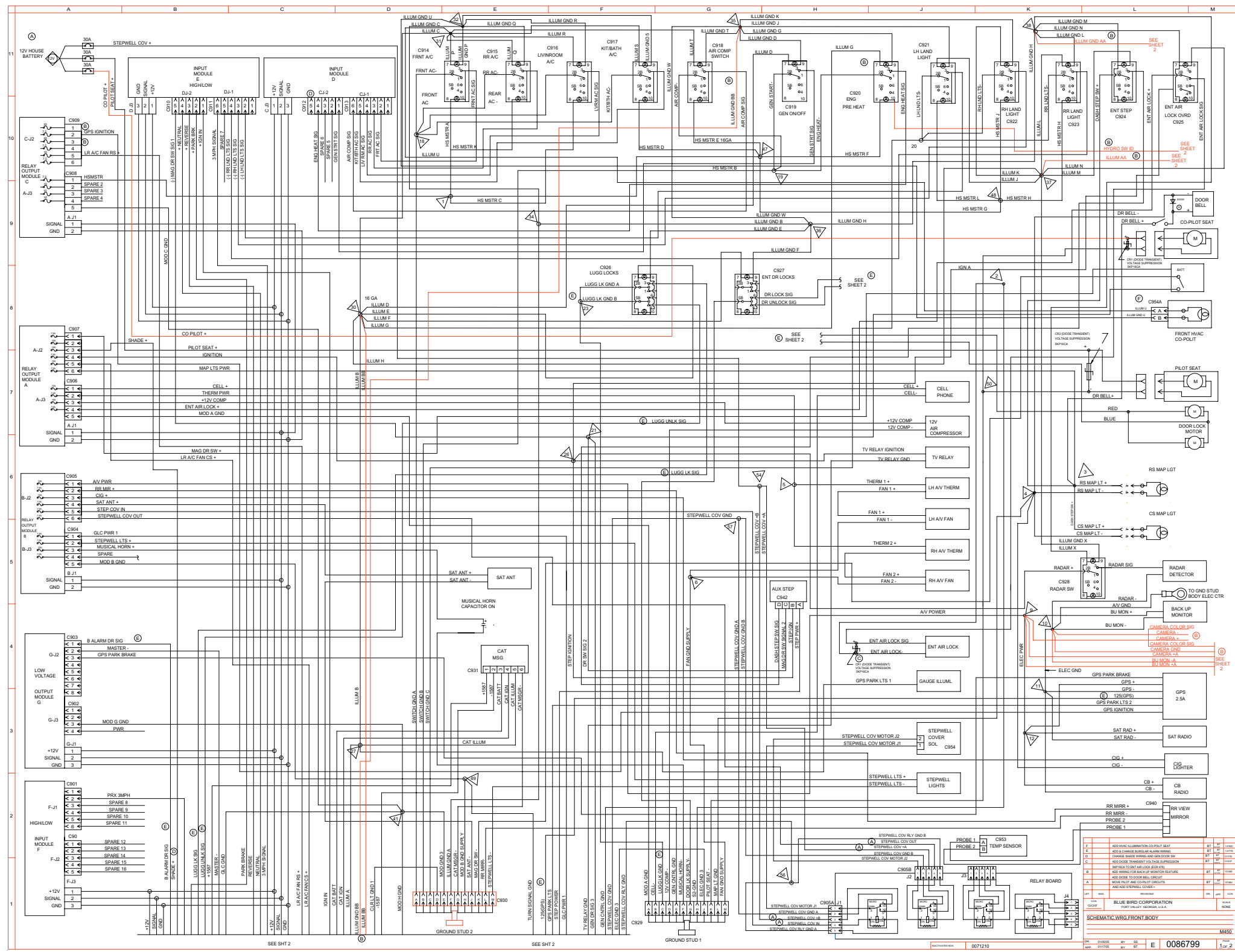

Wiring Schematic 0086799 - Front, Body\_Page 1 of 2 - Exploded View A

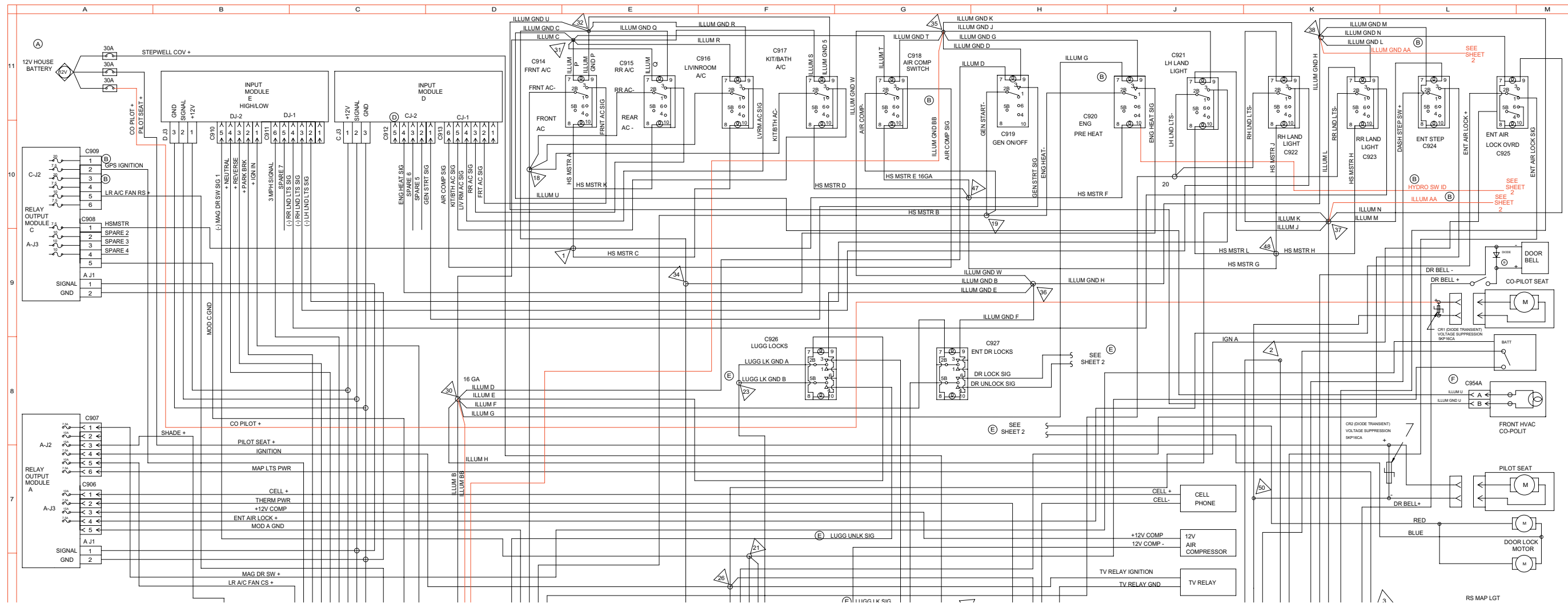

## Wiring Schematic 0086799 - Front, Body\_Page 1 of 2 - Exploded View B

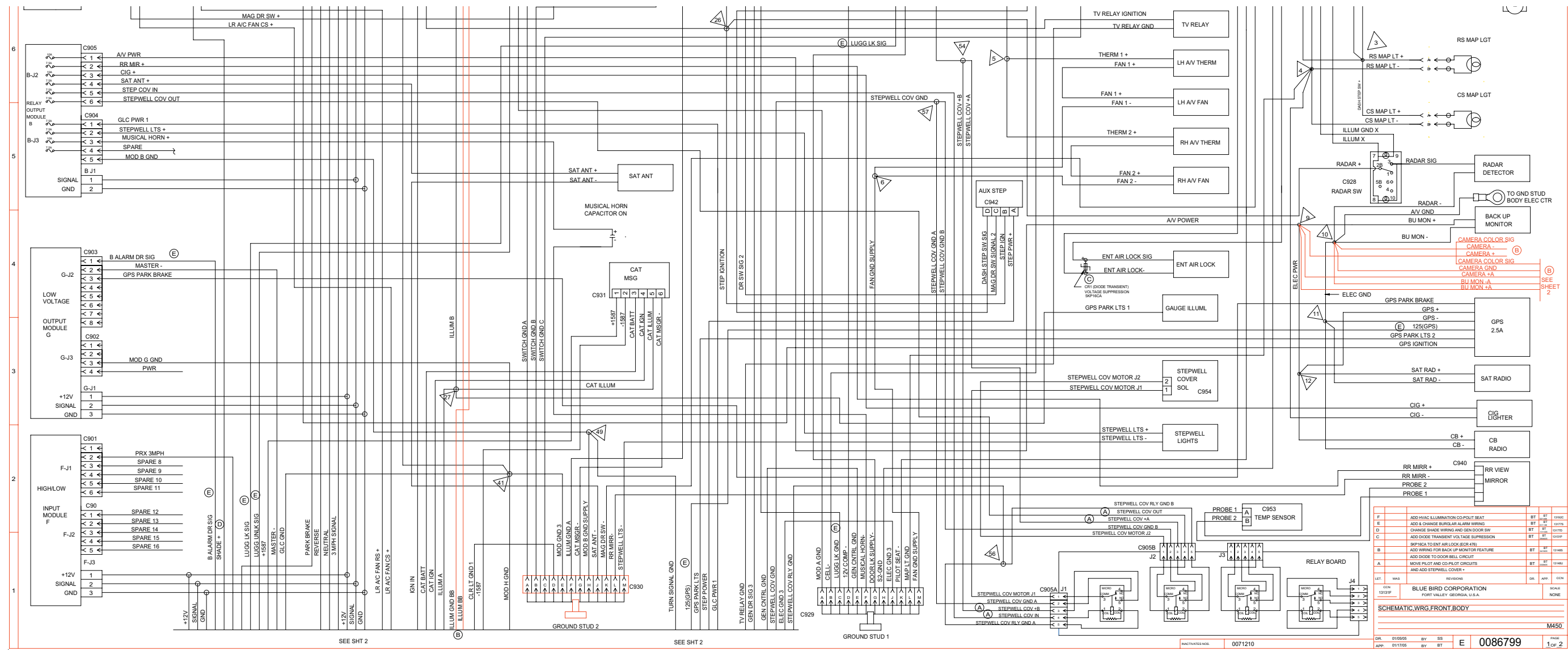

LET	WKS	REV	DATE	APP	CON
F				BT	10/06
E				BT	10/15
D				BT	10/15
C				BT	10/15
B				BT	10/15
A				BT	10/15

REV	DESCRIPTION	SCALE
1	BLUE BIRD CORPORATION	NONE
2	ADD HVAC ILLUMINATION CO-PILOT SEAT	
3	ADD & CHANGE BURGLAR ALARM WIRING	
4	CHANGE SHIELD WIRING AND GEN DOOR SW	
5	ADD DIODE TRANSPARENT VOLTAGE SUPPRESSION	
6	10P/NICA TO ENT AIR LOCK (SCR 478)	
7	ADD WIRING FOR BACK UP MONITOR FEATURE	
8	ADD DIODE TO DOOR BELL CIRCUIT	
9	MOVE PILOT AND CO-PILOT CIRCUITS	
10	AND ADD STEPWELL COVER +	

DR	DATE	BY	BT	SCALE
DR	01/05/05	BY	BT	NONE
APP	01/17/05	BY	BT	NONE

SCHEMATIC.WRG.FRONT.BODY

M450

0086799

1 of 2



Wiring Schematic 0086799 - Front, Body\_Page 2 of 2

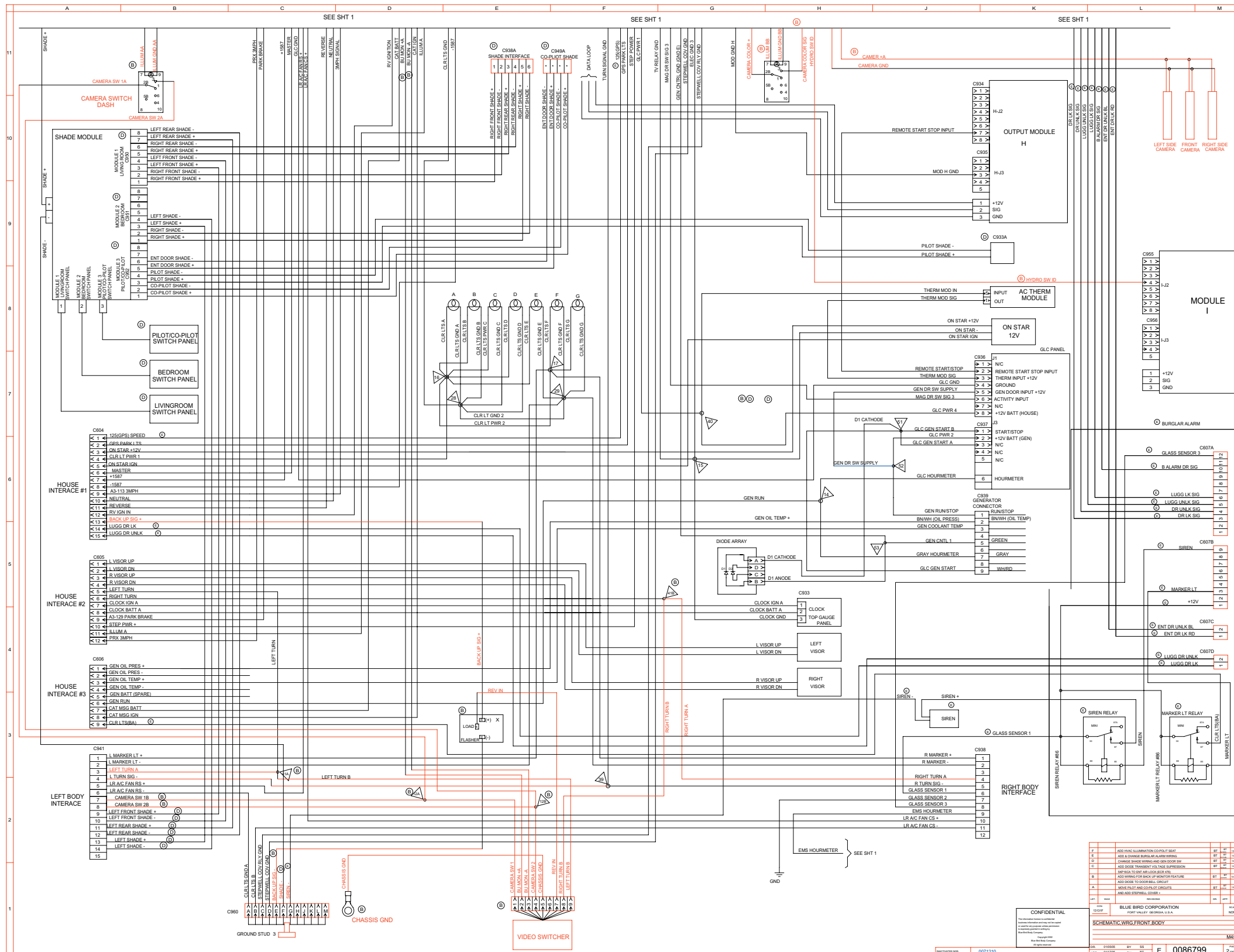

CONFIDENTIAL

BLUE BIRD CORPORATION  
17001 WILLOW, WILLOW, ILL. U.S.A.

SCHEMATIC: WIRC FRONT BODY

M450

DATE: 01/08/99 BY: SS E 0086799 2 of 2

Wiring Schematic 0086799 - Front, Body\_Page 2 of 2 - Exploded View A

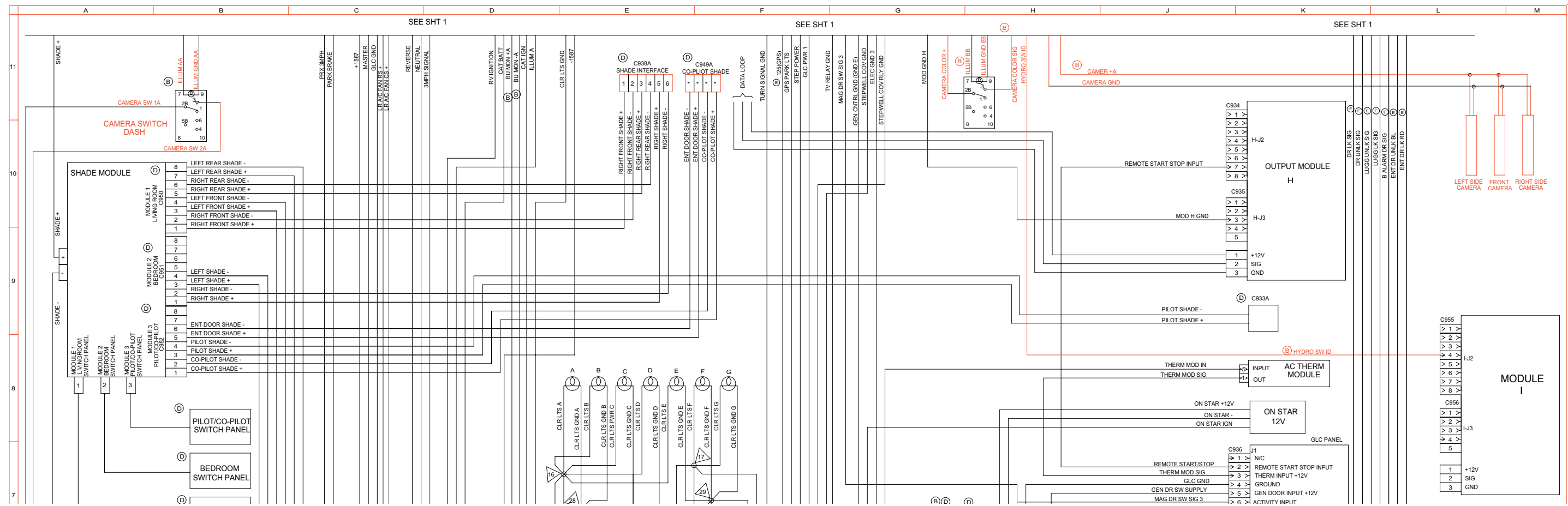

Wiring Schematic 0086799 - Front, Body\_Page 2 of 2 - Exploded View B

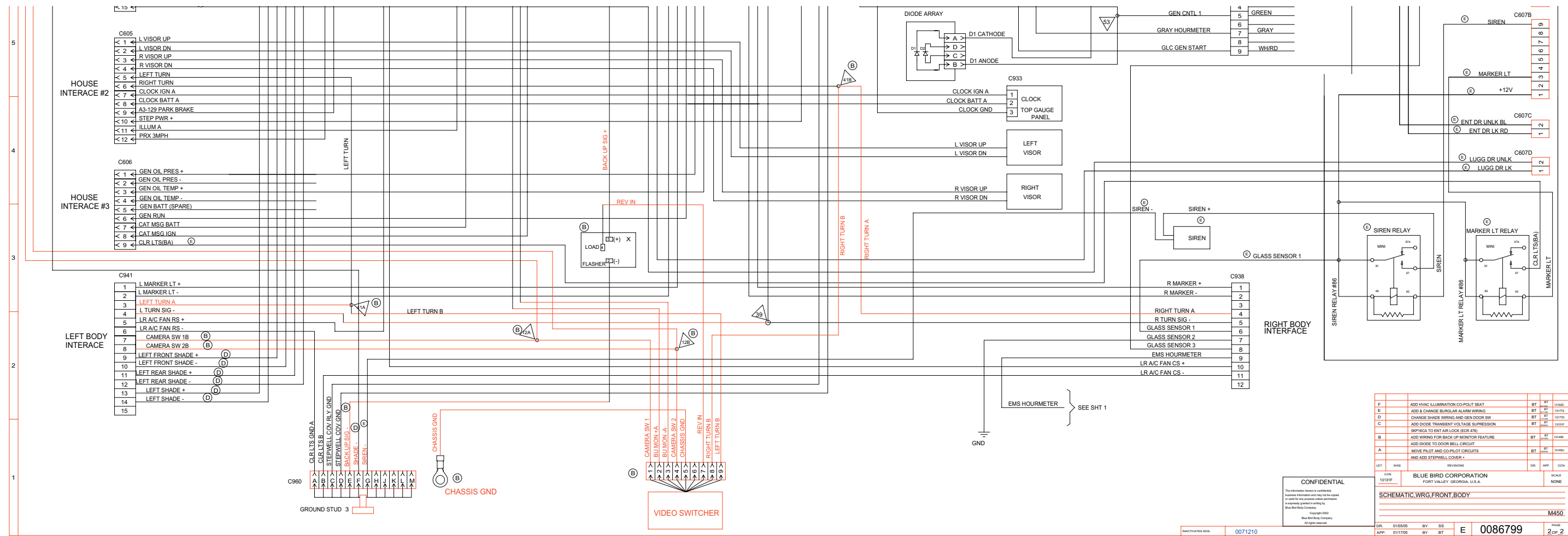

## Wiring Schematic 0076506 - Datalink

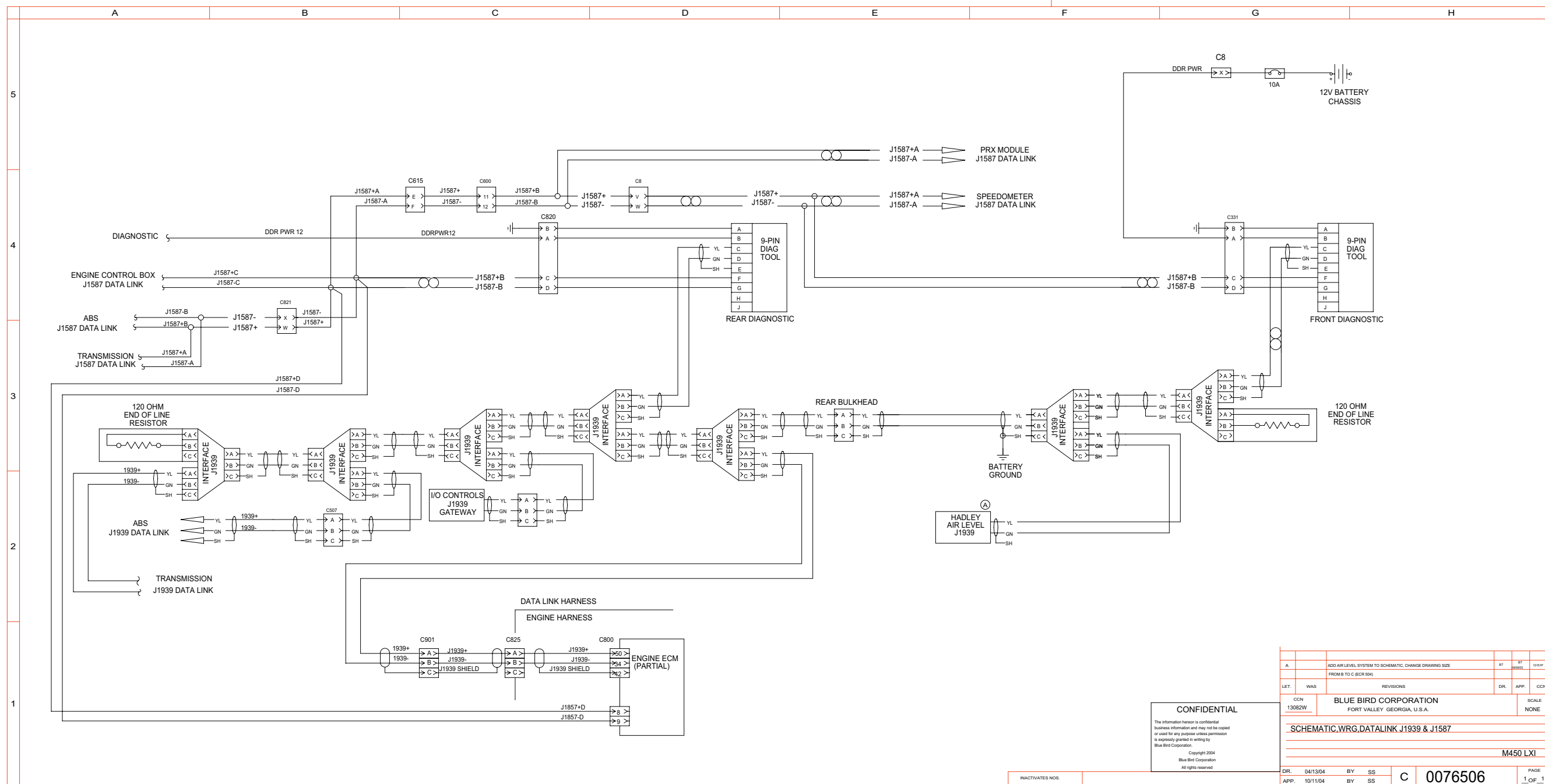

**CONFIDENTIAL**  
 The information herein is confidential business information and may not be copied or used for any purpose unless permission is expressly granted in writing by Blue Bird Corporation.  
 Copyright 2004  
 Blue Bird Corporation  
 All rights reserved.

ADD AIR LEVEL SYSTEM TO SCHEMATIC, CHANGE DRAWING SIZE FROM B TO C (SCR 506)	BT	BT	10/10P
REVISIONS	DR.	APP.	CCN
CCN 13082W	BLUE BIRD CORPORATION FORT VALLEY, GEORGIA, U.S.A.		SCALE NONE
SCHEMATIC.WRG.DATALINK J1939 & J1587			
M450 LXI			
DR. 04/13/04	BY SS	C	PAGE 1 OF 1
APP. 10/11/04	BY SS	0076506	

Wiring Schematic 0075796 - Living Room, Bedroom, C/S

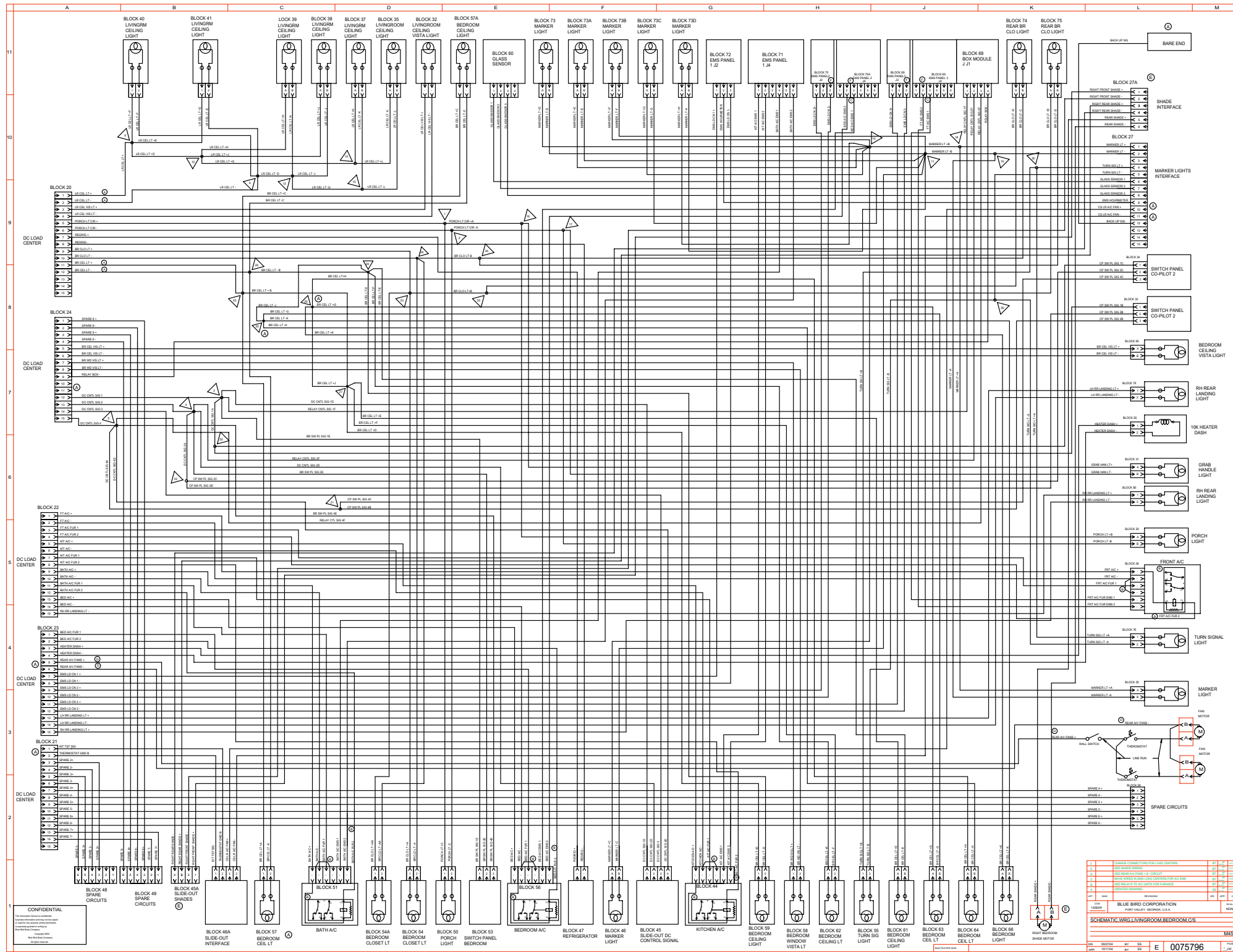

Wiring Schematic 0100164 - Living Room, Bedroom, R/S

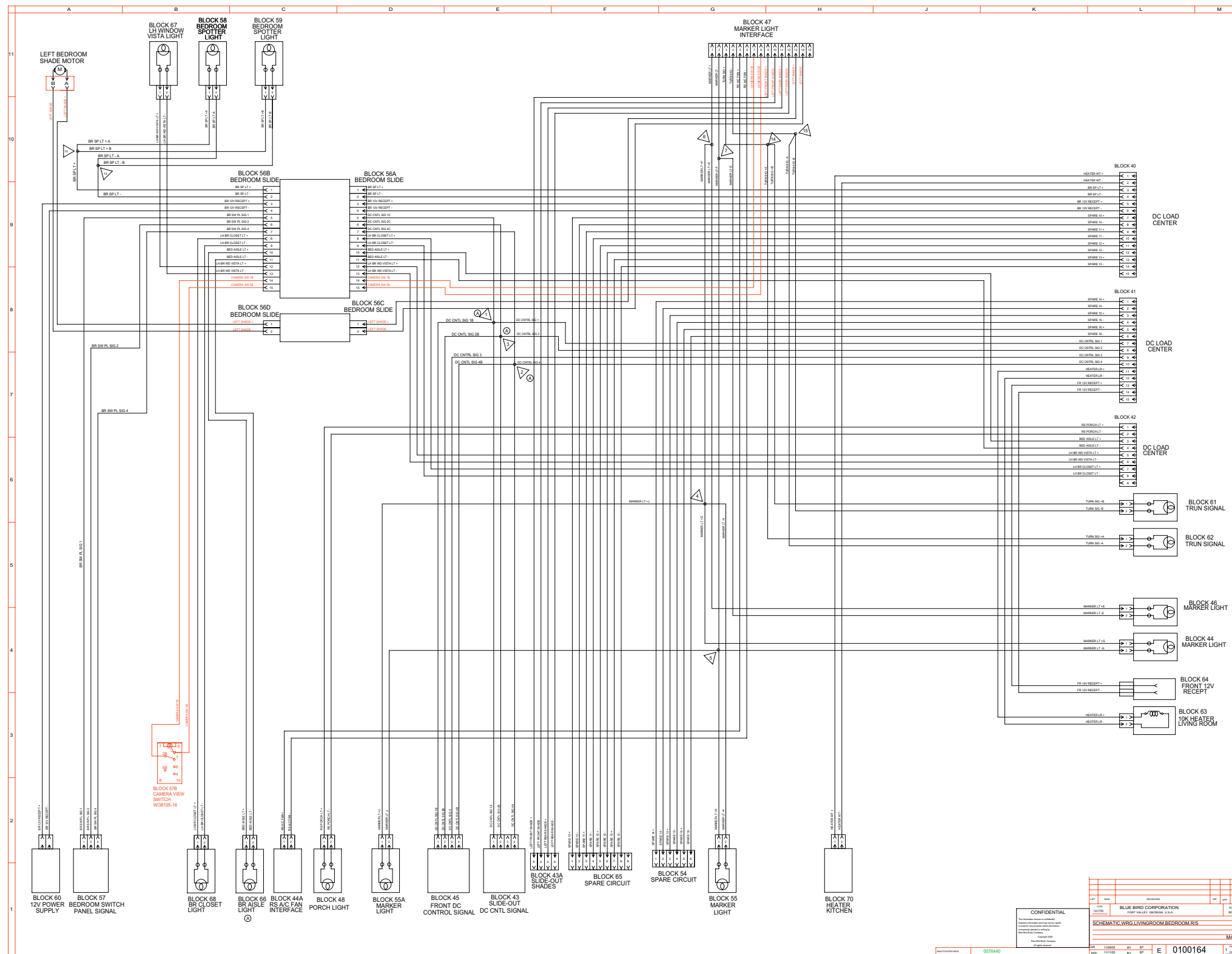

Wiring Schematic 0100164 - Living Room, Bedroom, R/S - Exploded View A

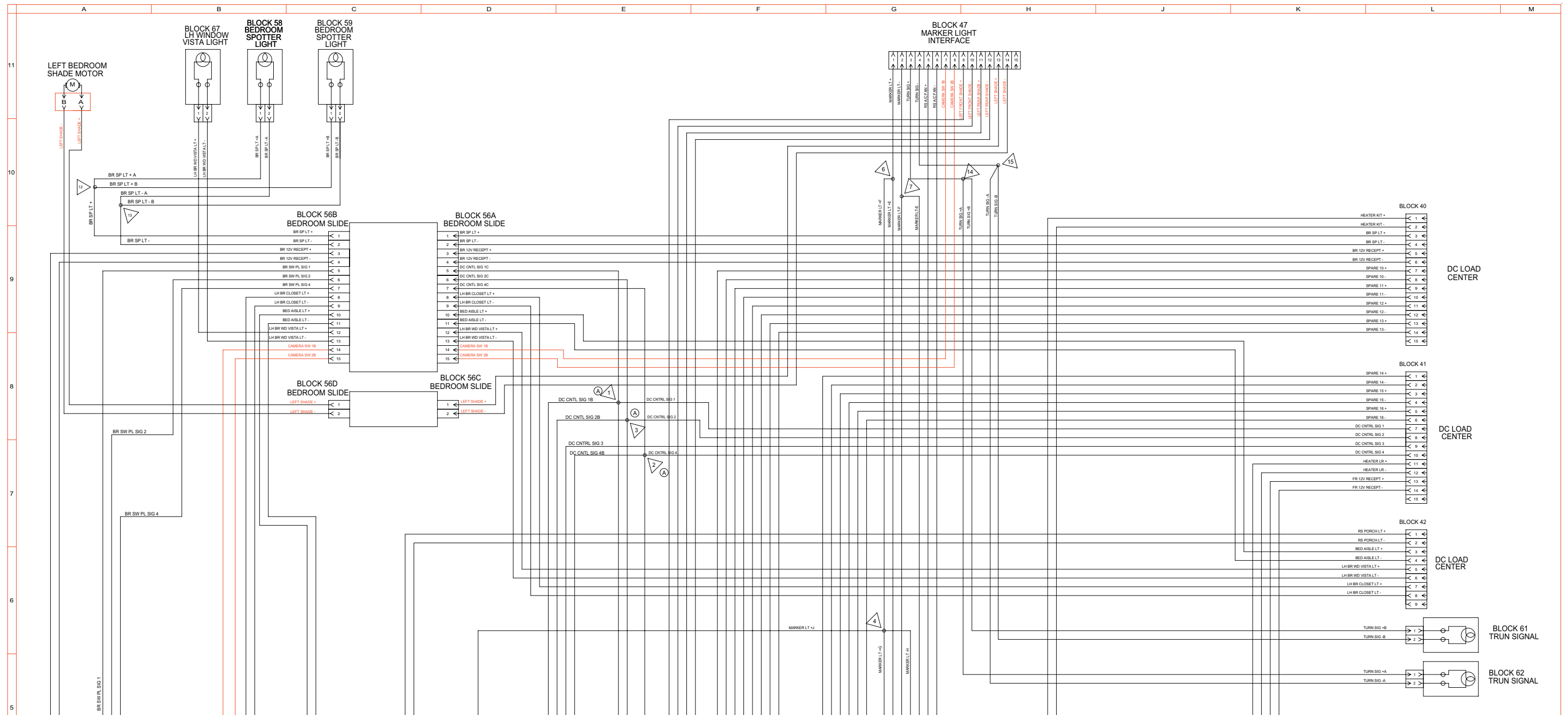

## Wiring Schematic 0100164 - Living Room, Bedroom, R/S - Exploded View B

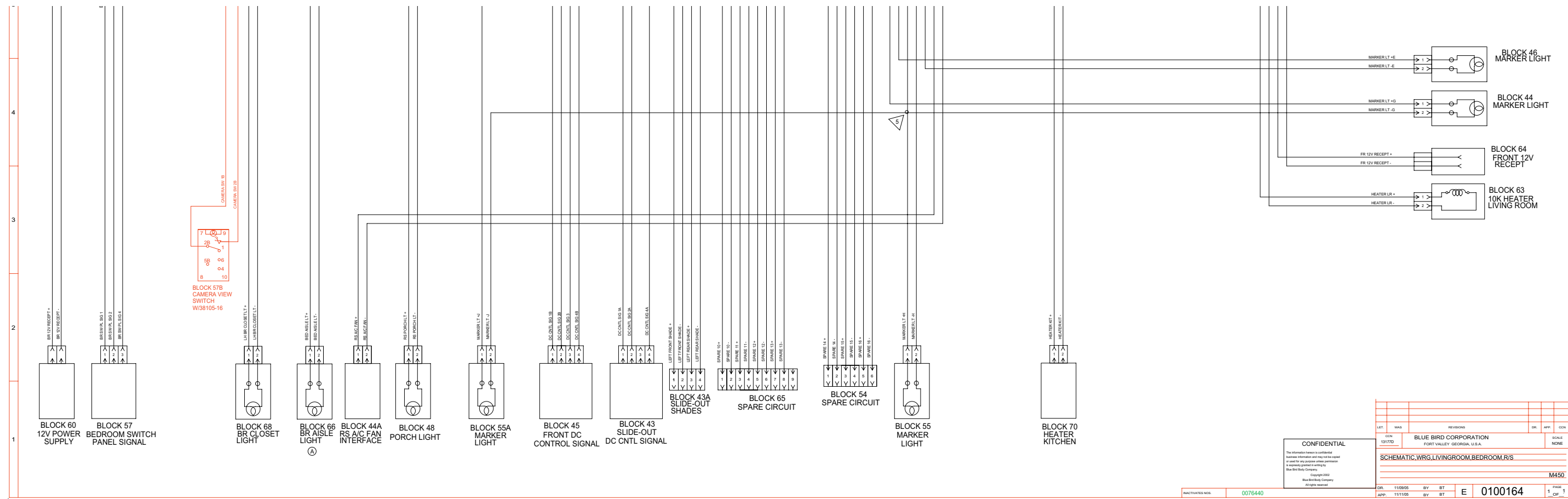



Wiring Schematic 0081856 - Living/Dining Room, Slide-Out, Bath Floorplan A

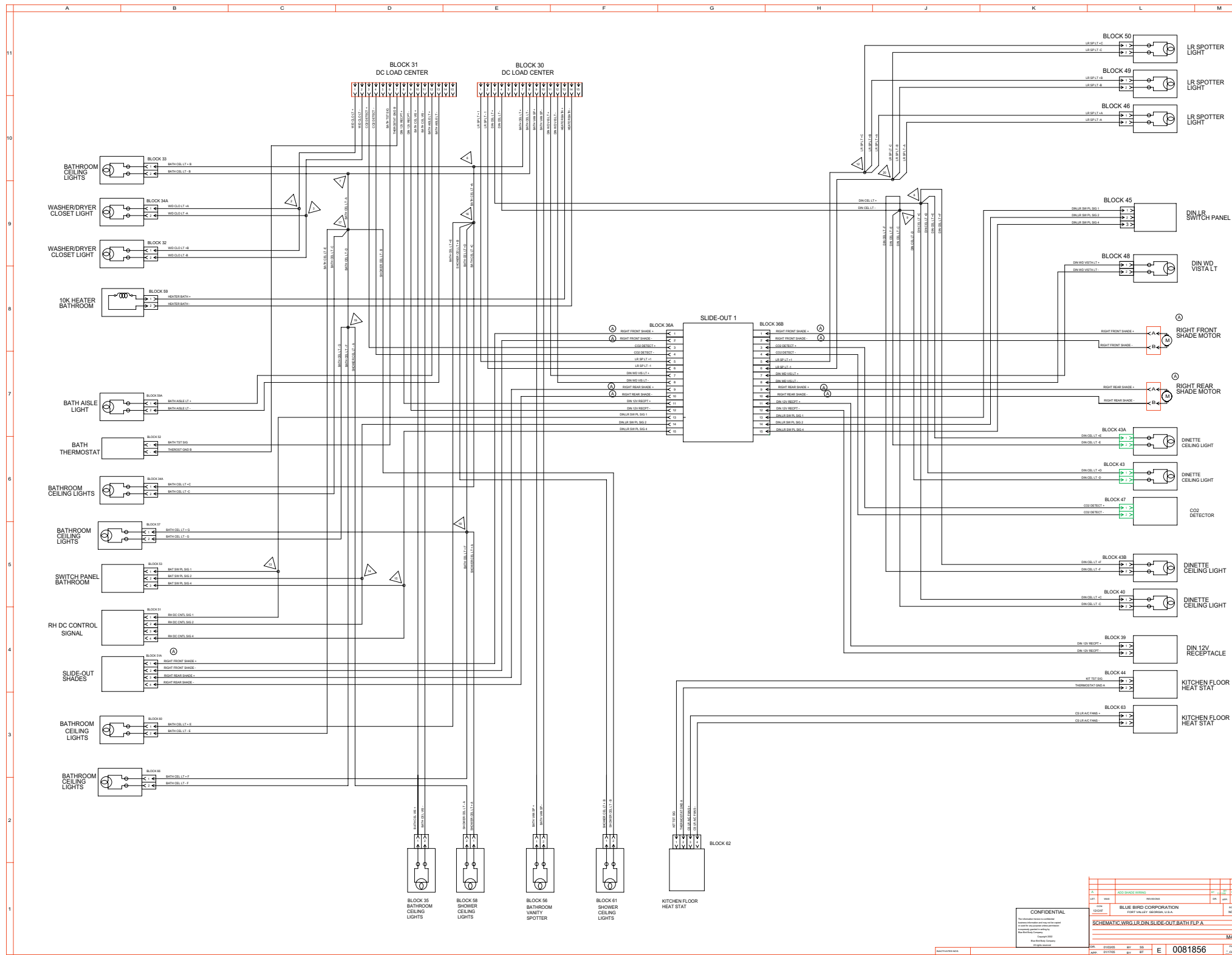

Wiring Schematic 0081856 - Living/Dining Room, Slide-Out, Bath Floorplan A - Exploded View A

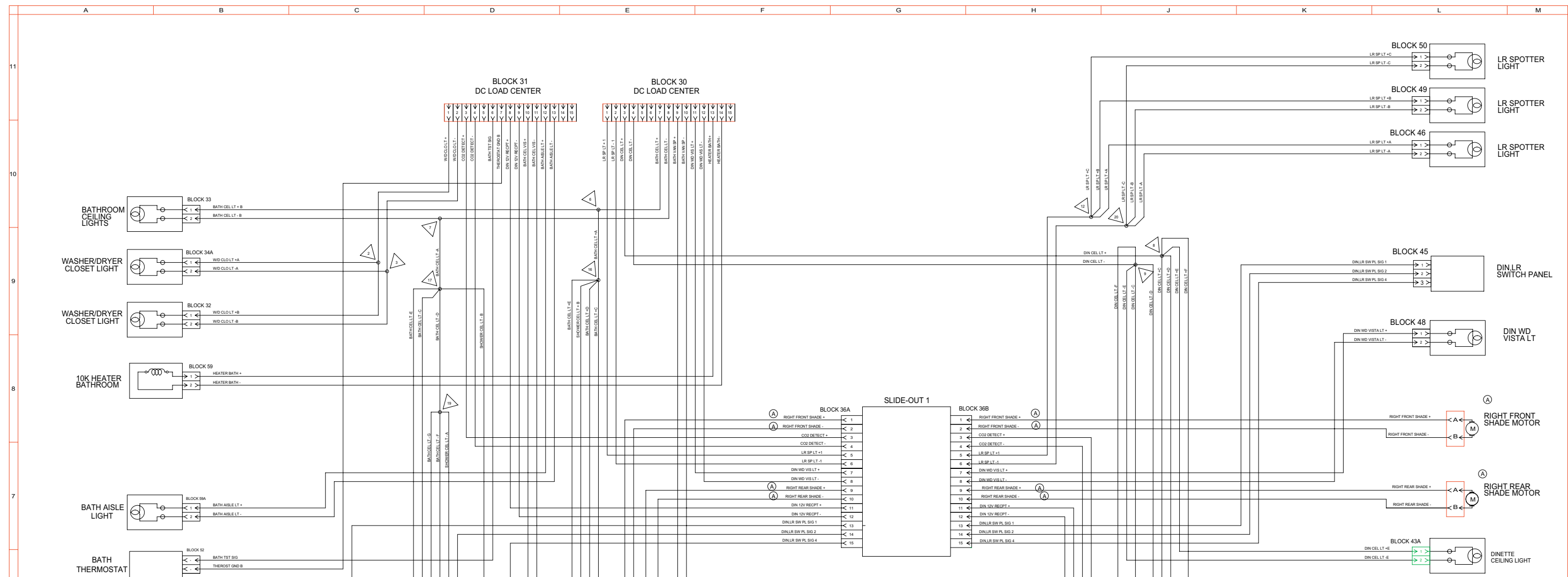

Wiring Schematic 0081856 - Living/Dining Room, Slide-Out, Bath Floorplan A - Exploded View B

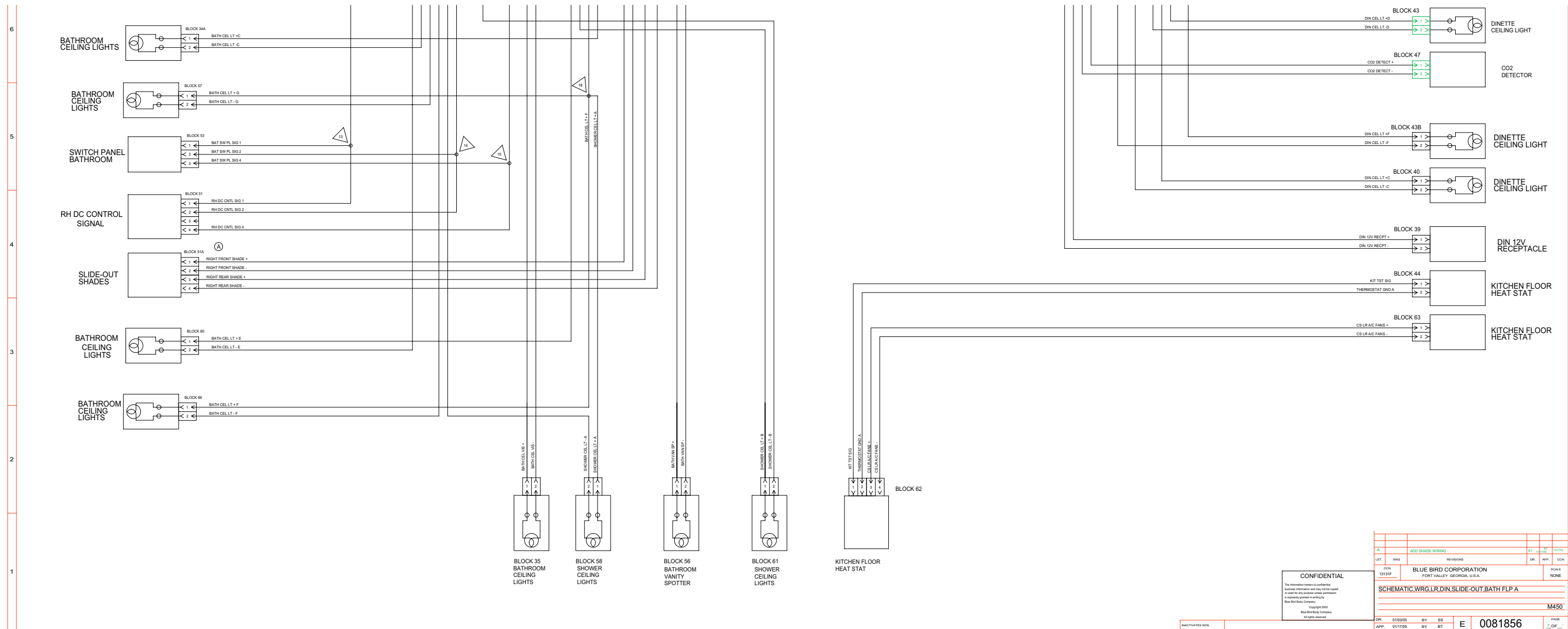

Wiring Schematic 0086740 - Living/Dining Room, Slide-Out, Bath Floorplan B

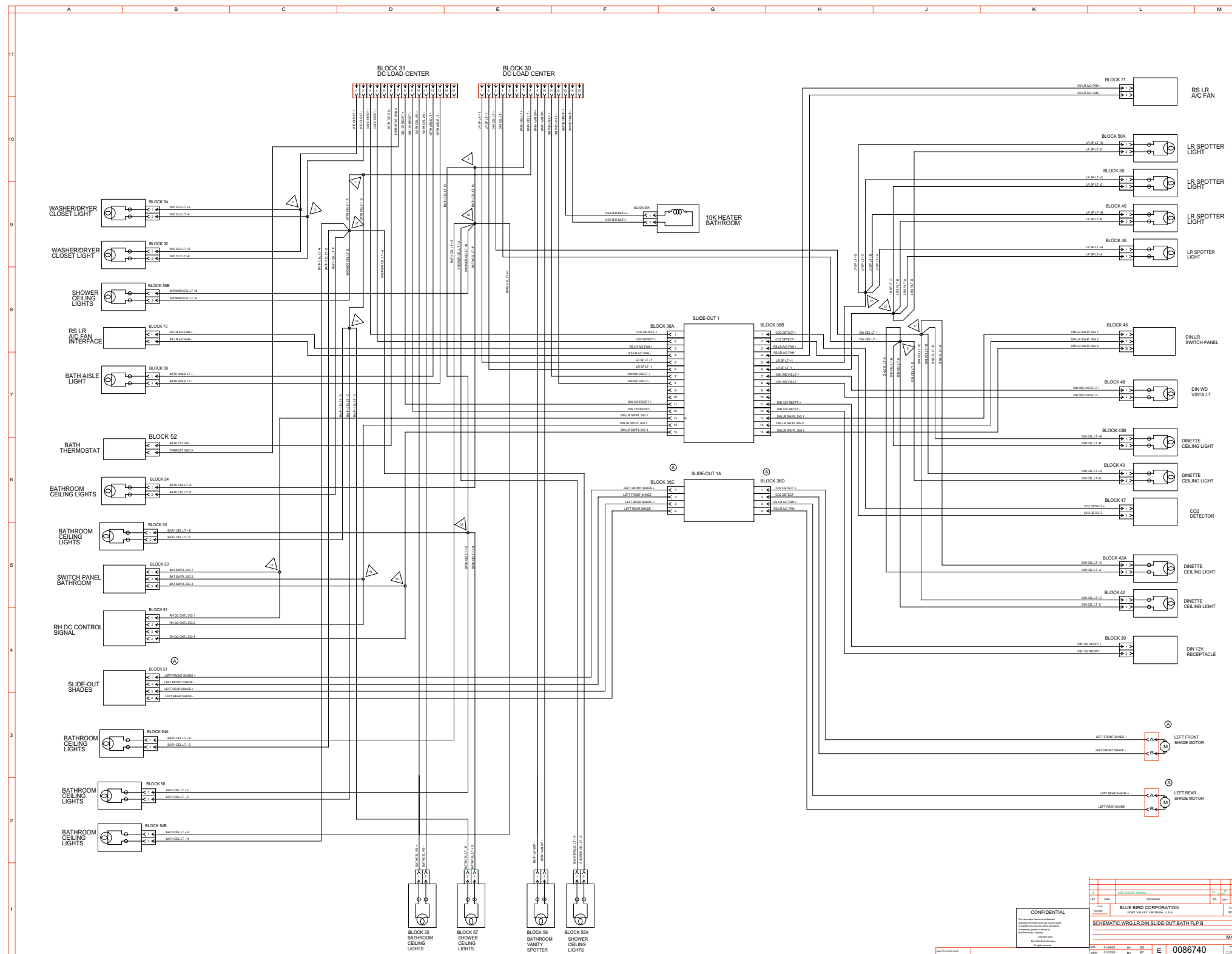

Wiring Schematic 0086740 - Living/Dining Room, Slide-Out, Bath Floorplan B - Exploded View A

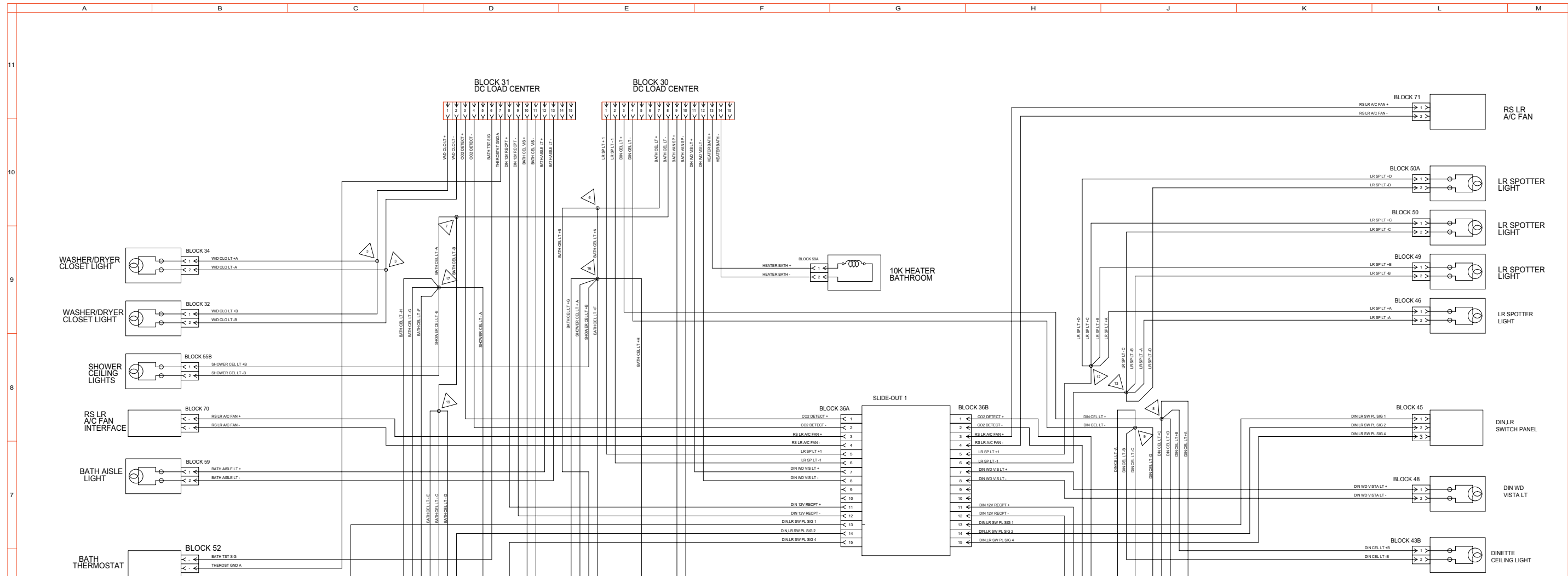

## Wiring Schematic 0086740 - Living/Dining Room, Slide-Out, Bath Floorplan B - Exploded View B

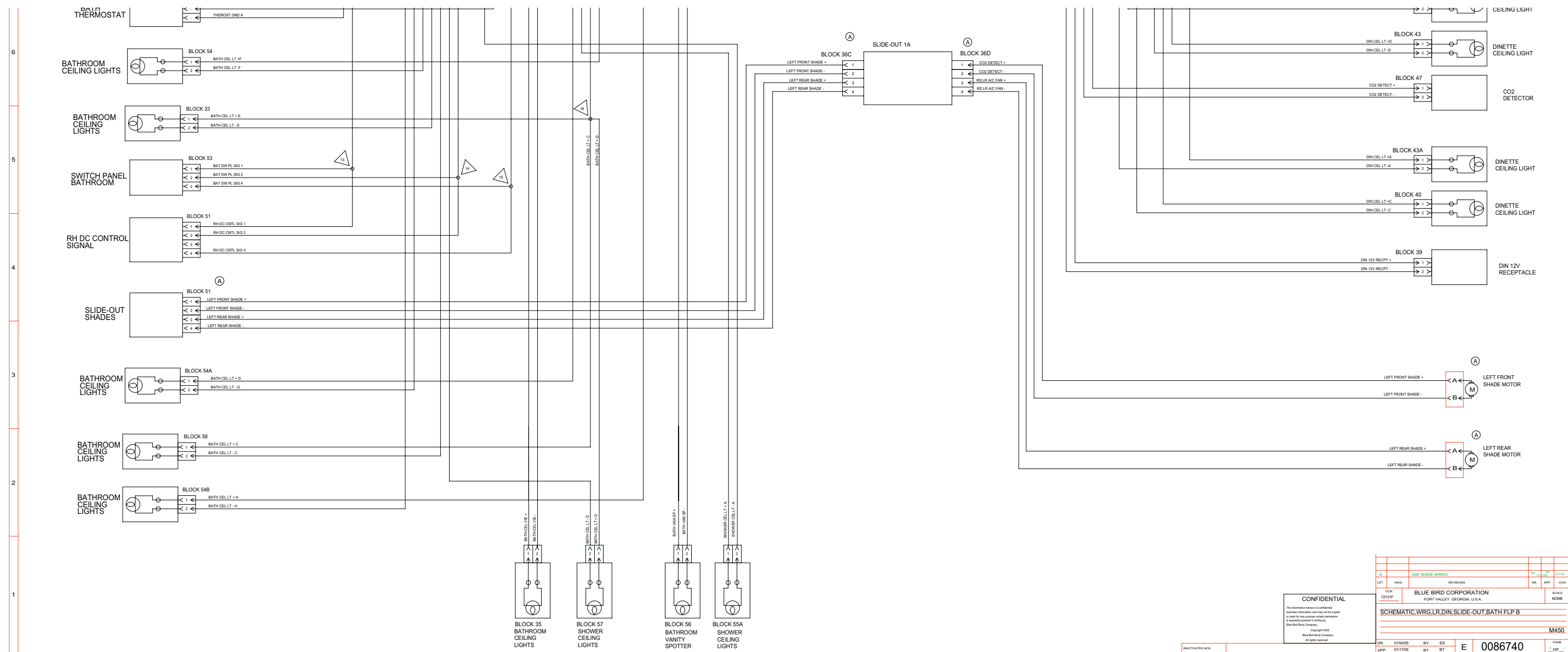

Wiring Schematic 0076147 - Bay, DC, Load Center - Page 1 of 2

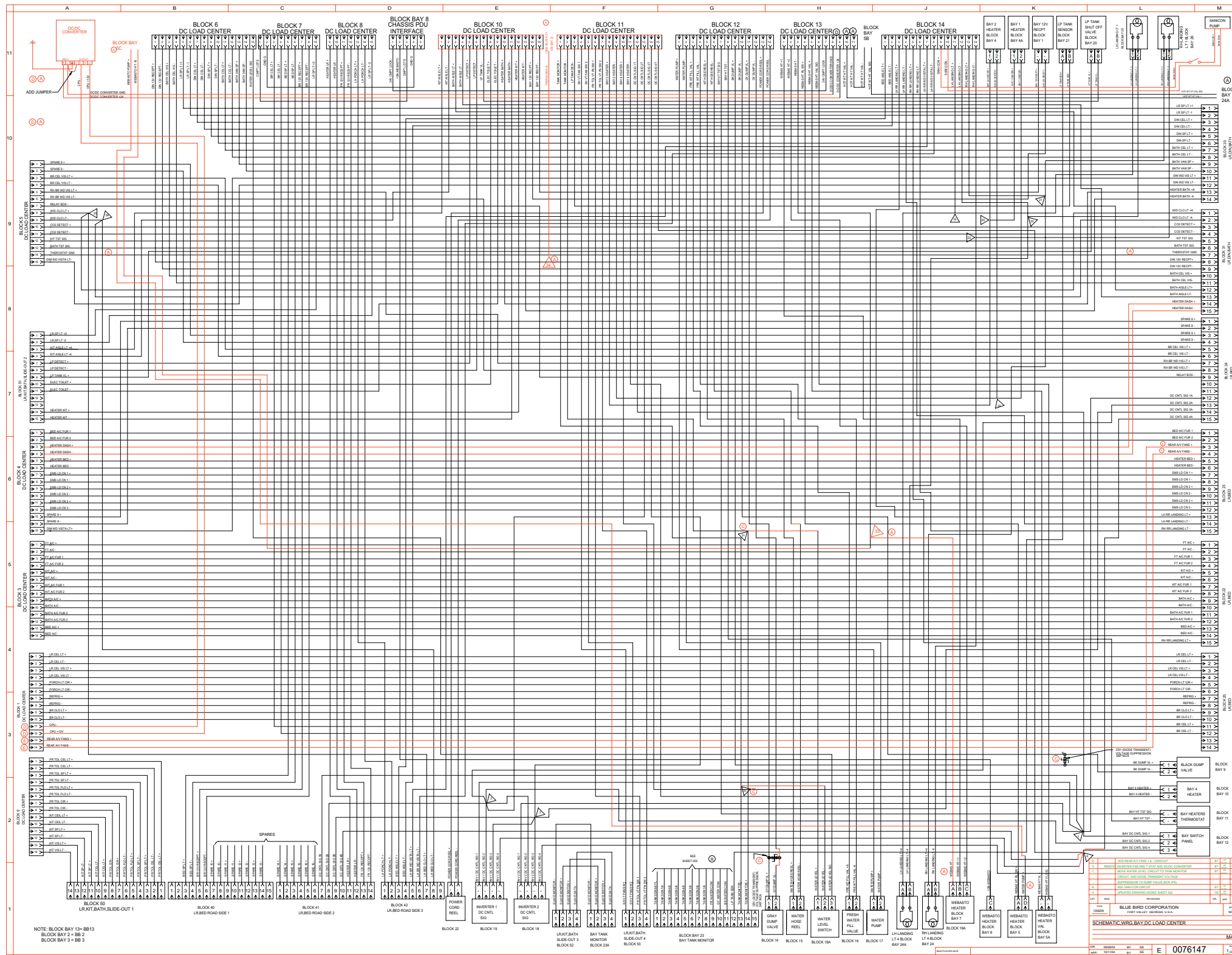

Wiring Schematic 0076147 - Bay, DC, Load Center - Page 1 of 2 - Exploded View A

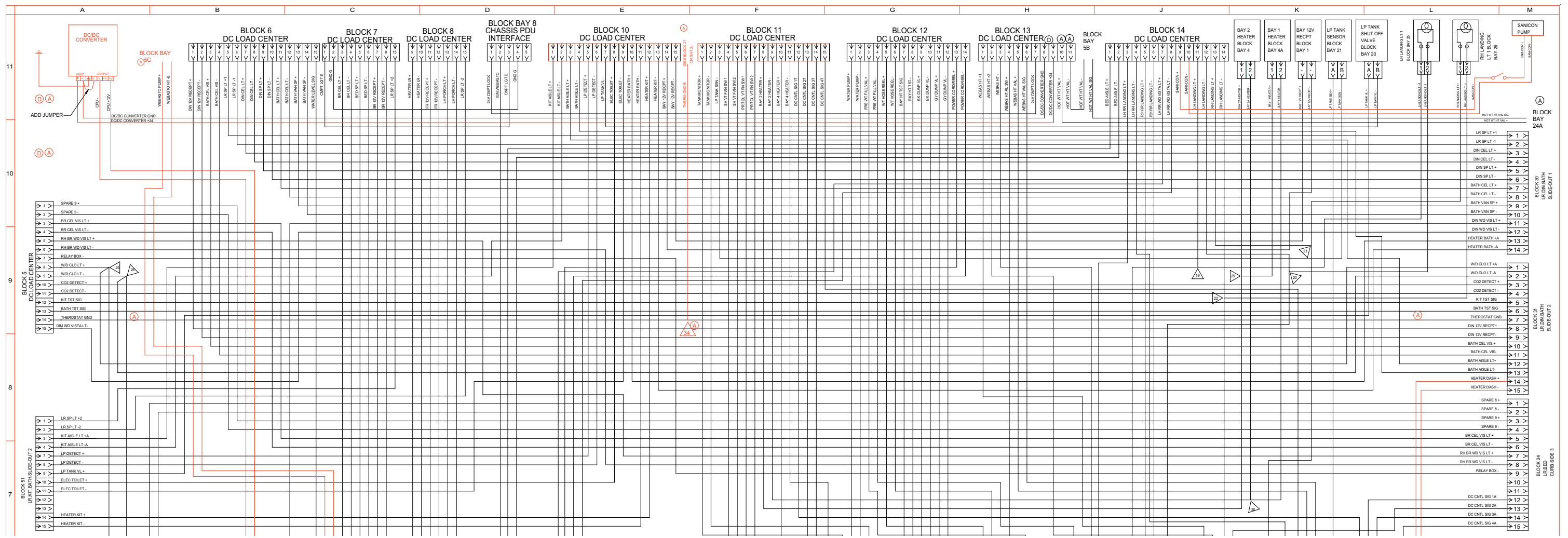



Wiring Schematic 0076147 - Bay, DC, Load Center - Page 1 of 2 - Exploded View B

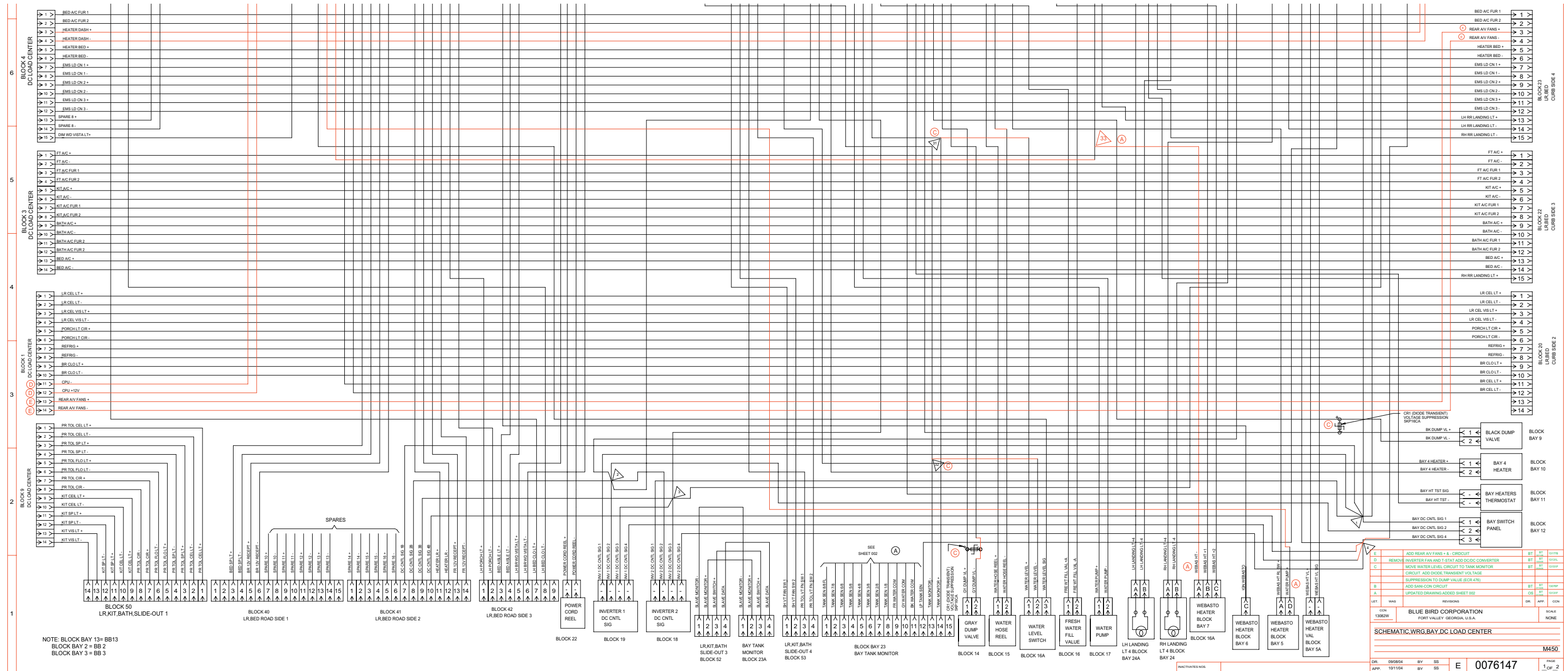

NOTE: BLOCK BAY 13= BB13  
 BLOCK BAY 2 = BB 2  
 BLOCK BAY 3 = BB 3

LET	WAS	REVISIONS	DR.	APP.	CON.
CON 13082W BLUE BIRD CORPORATION FORT VALLEY, GEORGIA, U.S.A. SCALE NONE					
SCHEMATIC.WRG.BAY.DC.LOAD CENTER					
M450					
DR.	080804	BY	SS	E	0076147
APP.	101104	BY	SS		1 OF 2

Wiring Schematic 0076147 - Bay, DC, Load Center - Page 2 of 2

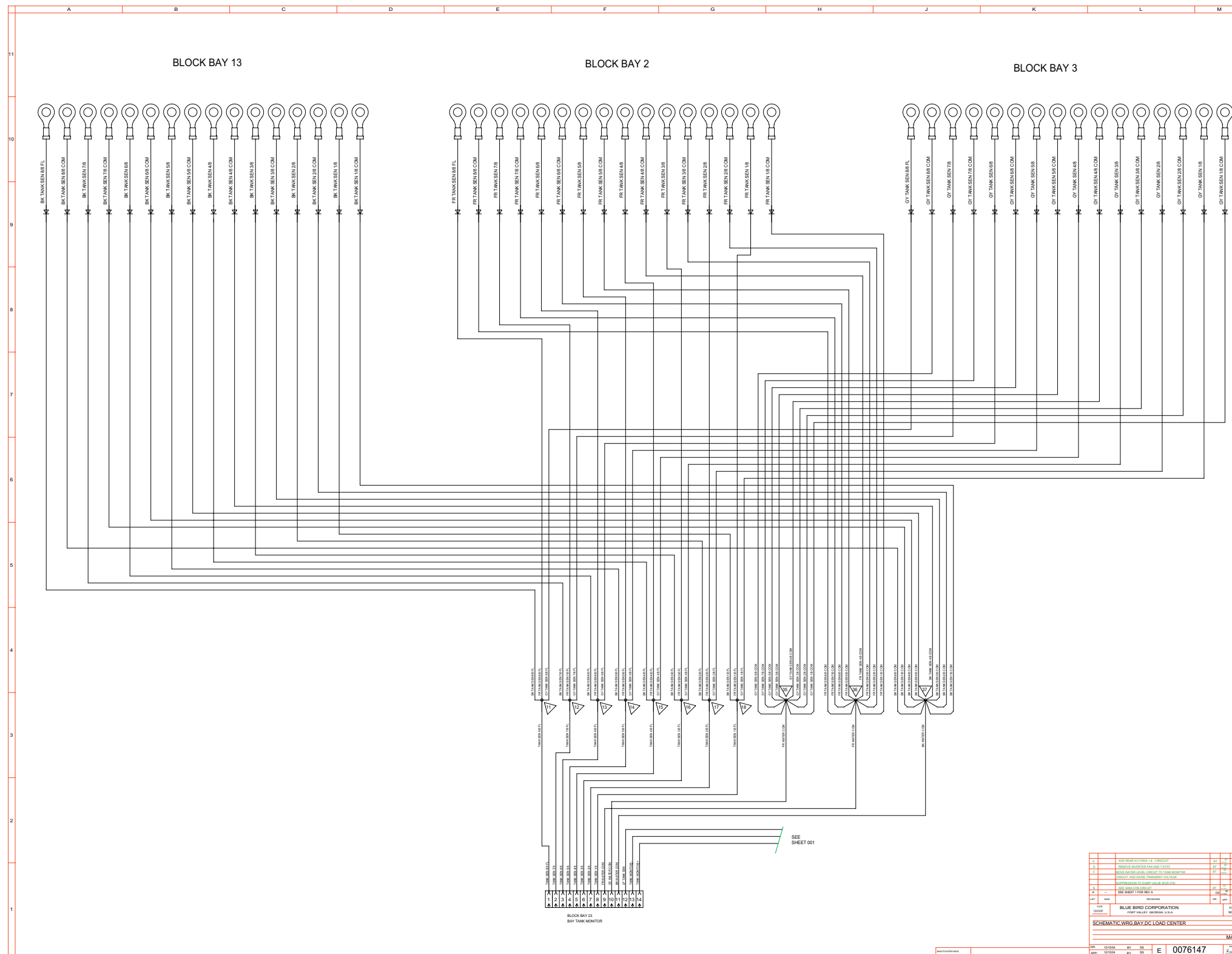

Wiring Schematic 0076203 - Bay Multiplex

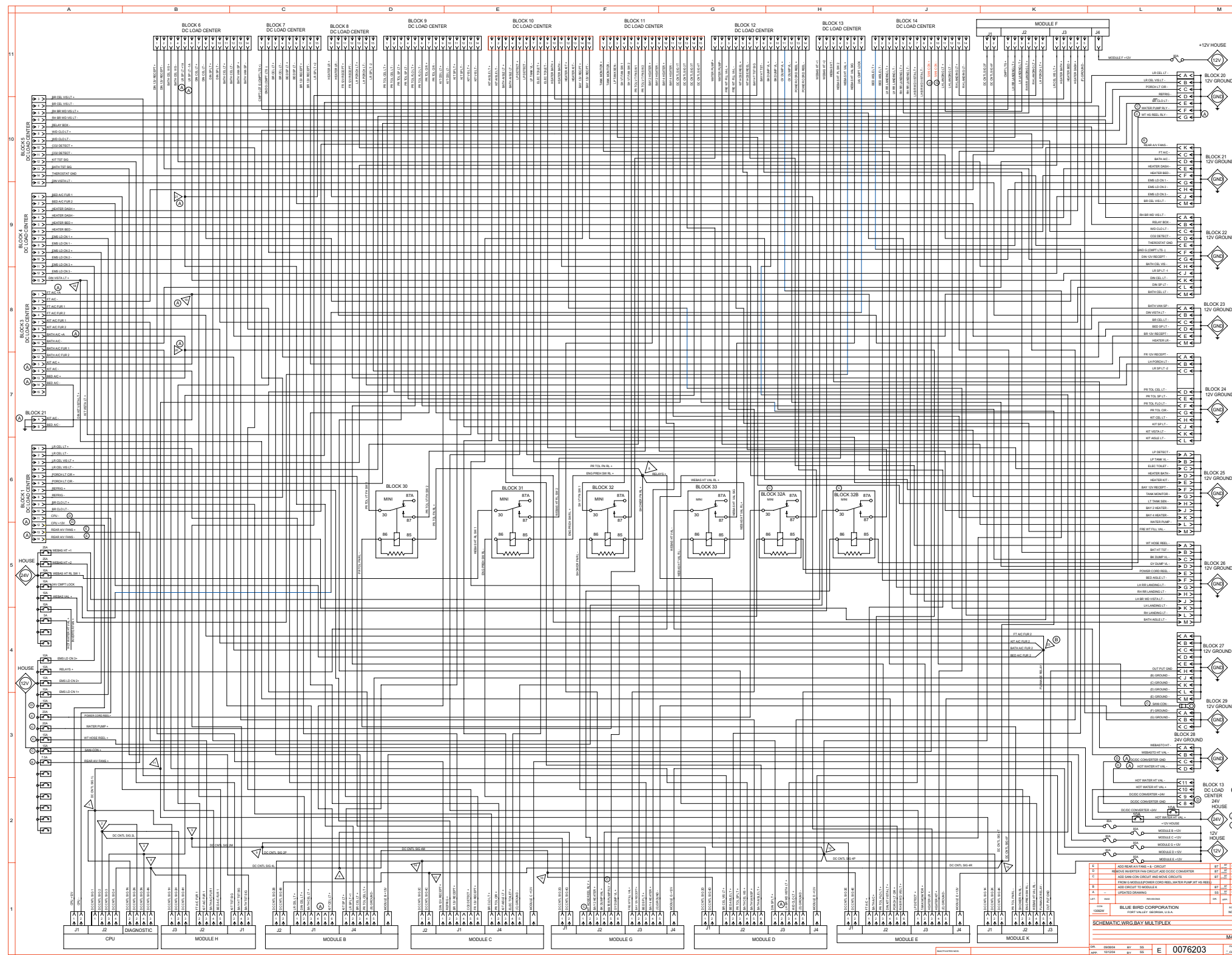

Wiring Schematic 0076203 - Bay Multiplex - Exploded View A

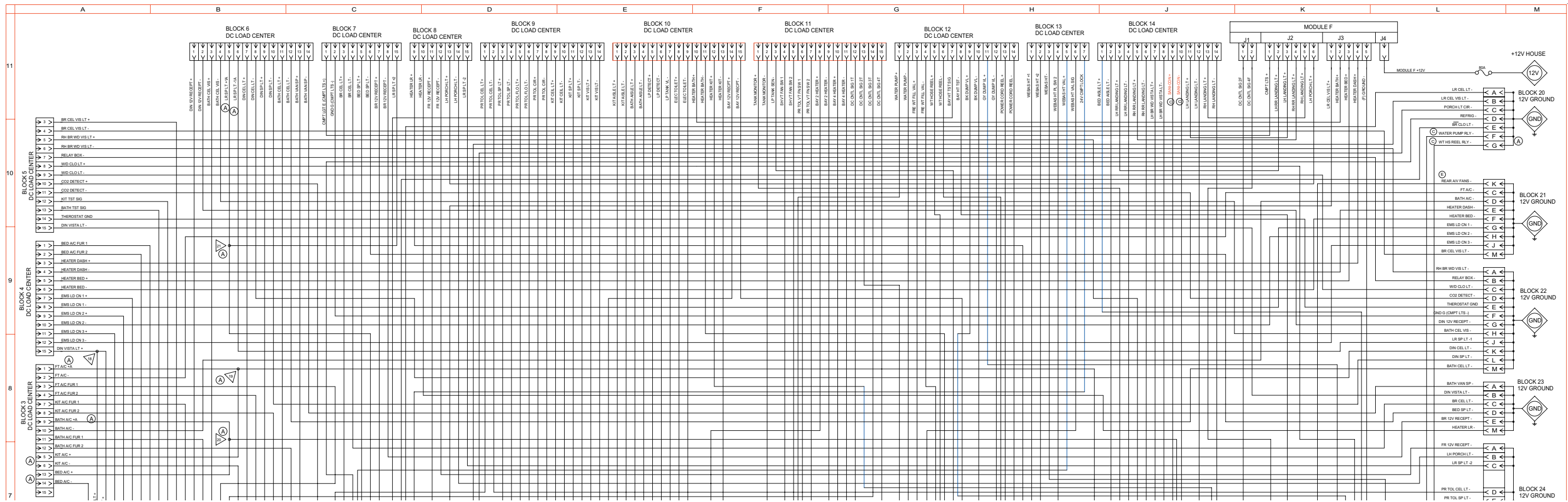

Wiring Schematic 0076203 - Bay Multiplex - Exploded View B

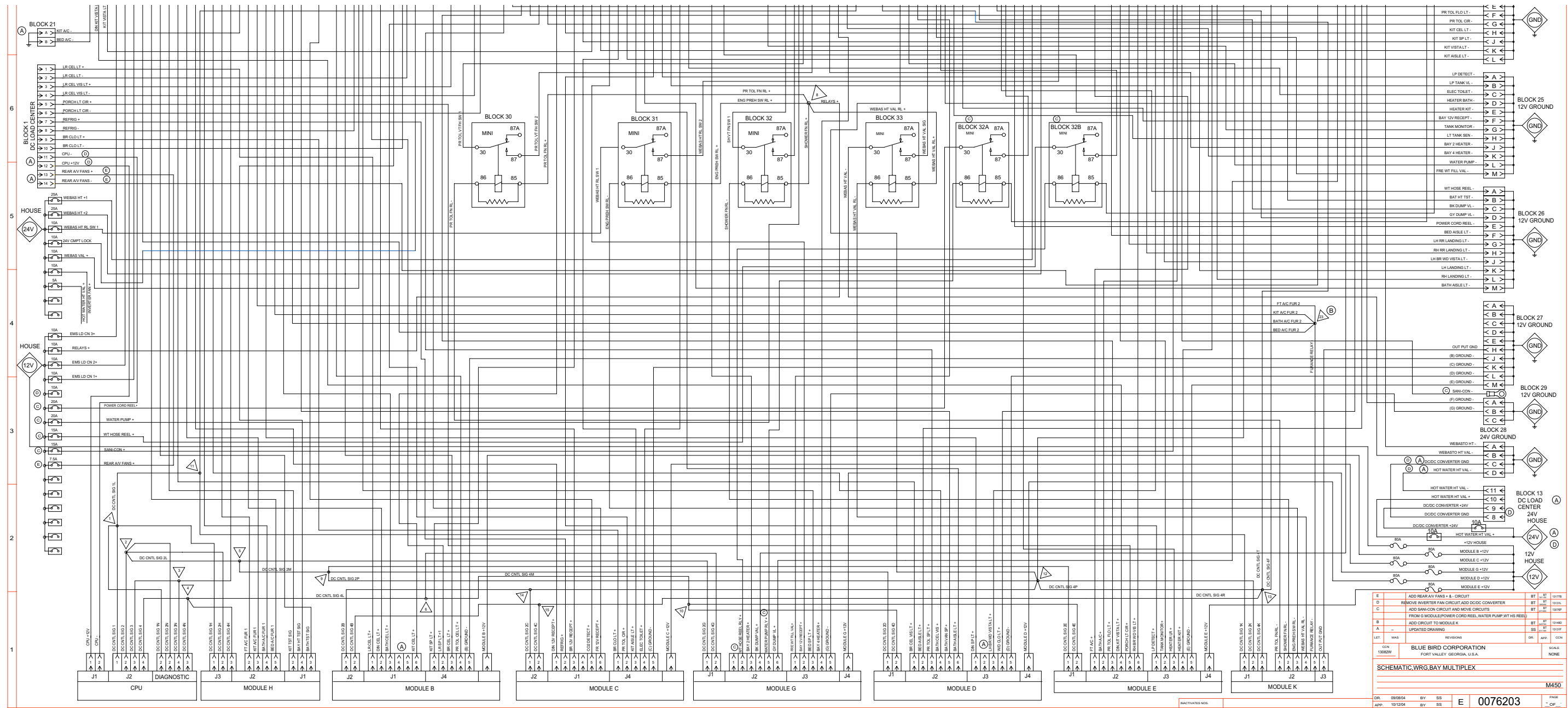

Wiring Schematic 0069318 - Overhead Panel, L/H Gauges

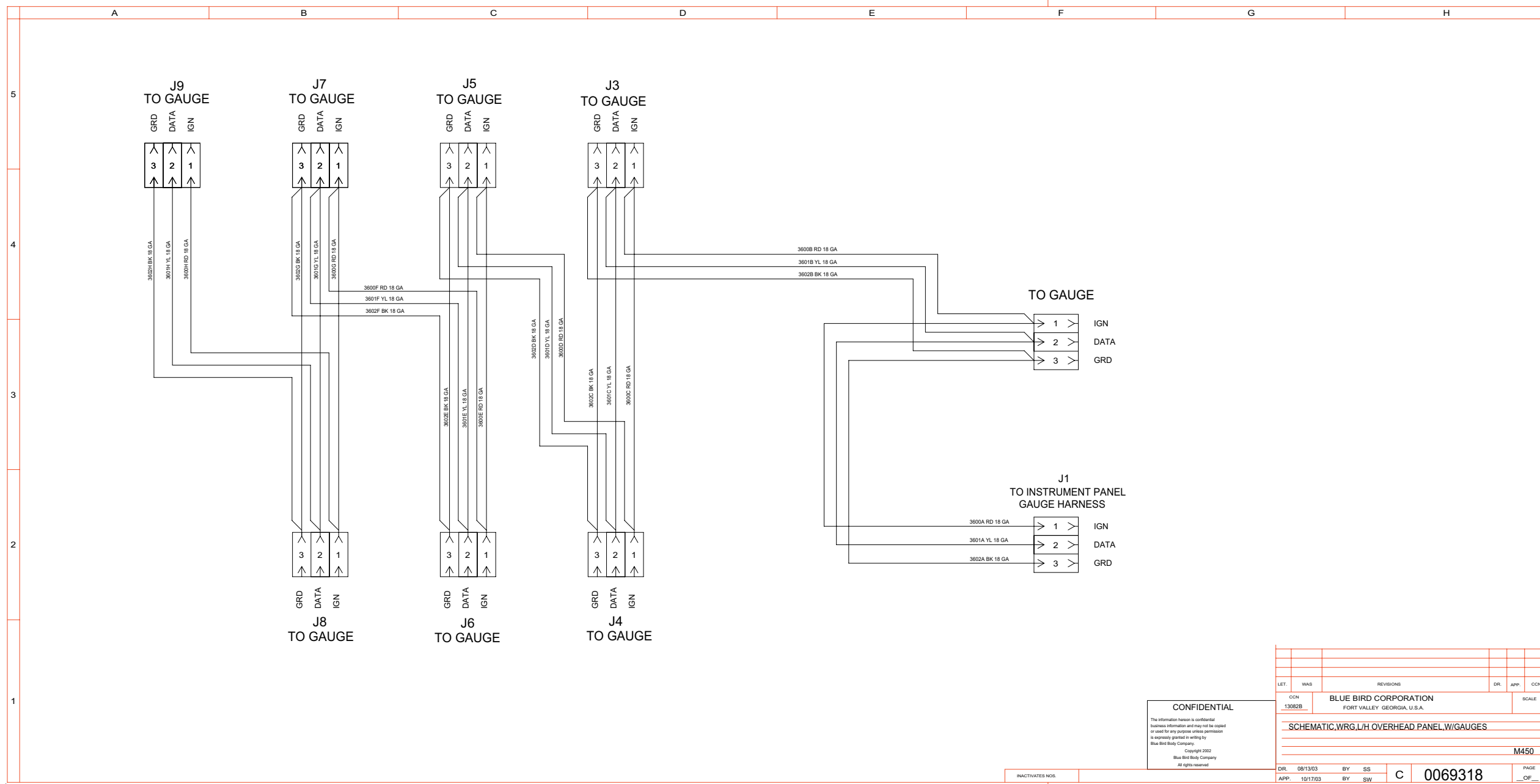

**CONFIDENTIAL**  
 The information herein is confidential business information and may not be copied or used for any purpose unless permission is expressly granted in writing by Blue Bird Body Company.  
 Copyright 2002  
 Blue Bird Body Company  
 All rights reserved.

LET:	WAS	REVISIONS	DR:	APP:	CCN:
CCN:	BLUE BIRD CORPORATION				SCALE:
130828	FORT VALLEY, GEORGIA, U.S.A.				
SCHEMATIC, WRG, L/H OVERHEAD PANEL, W/GAUGES					
M450					
DR:	08/13/03	BY:	SS	C	0069318
APP:	10/17/03	BY:	SW		PAGE
					_ OF _

Wiring Schematic 0075037 - Slide-Out Controller, 3 Room - Page 1 of 3

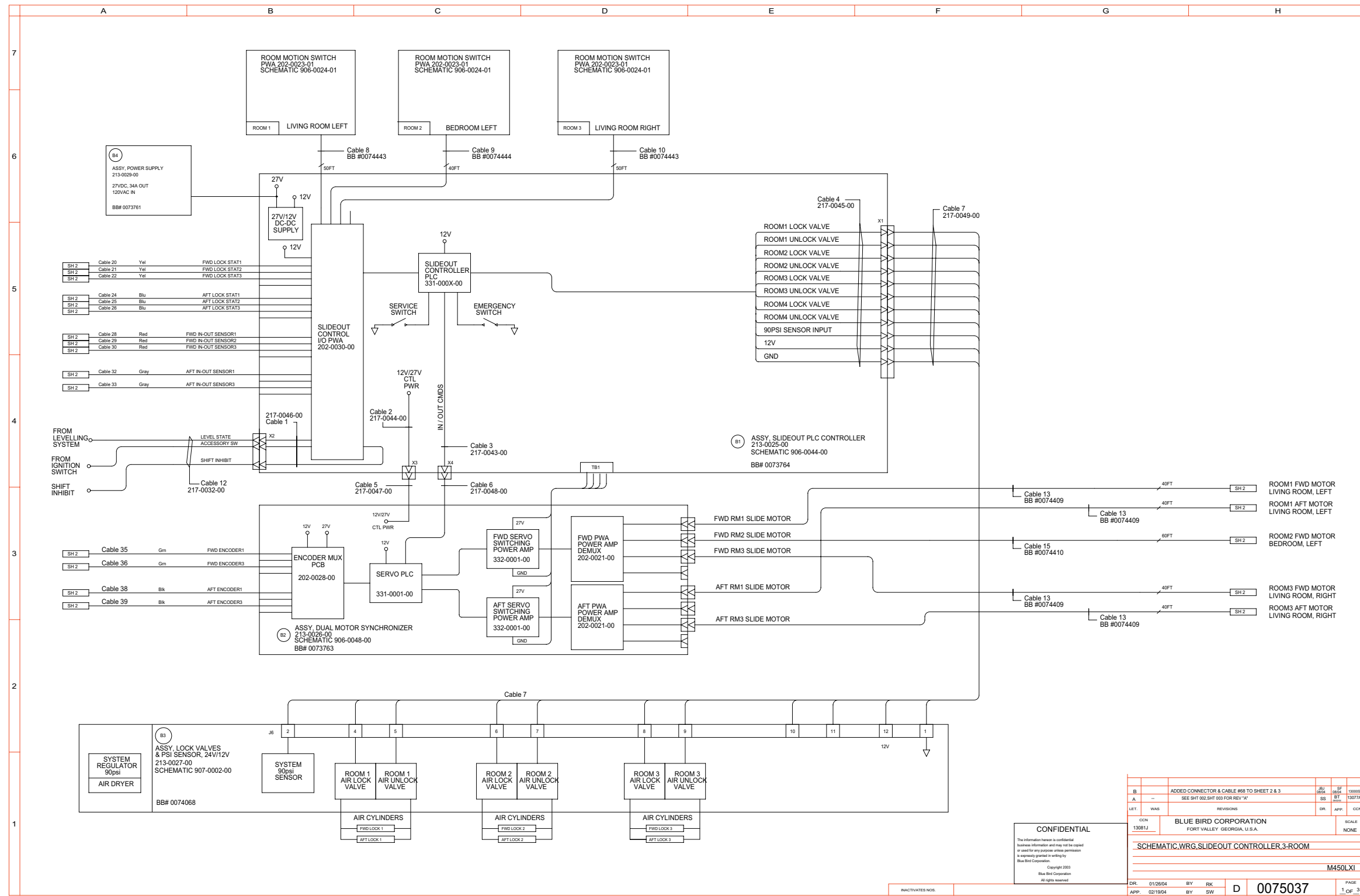

Wiring Schematic 0075037 - Slide-Out Controller, 3 Room - Page 2 of 3

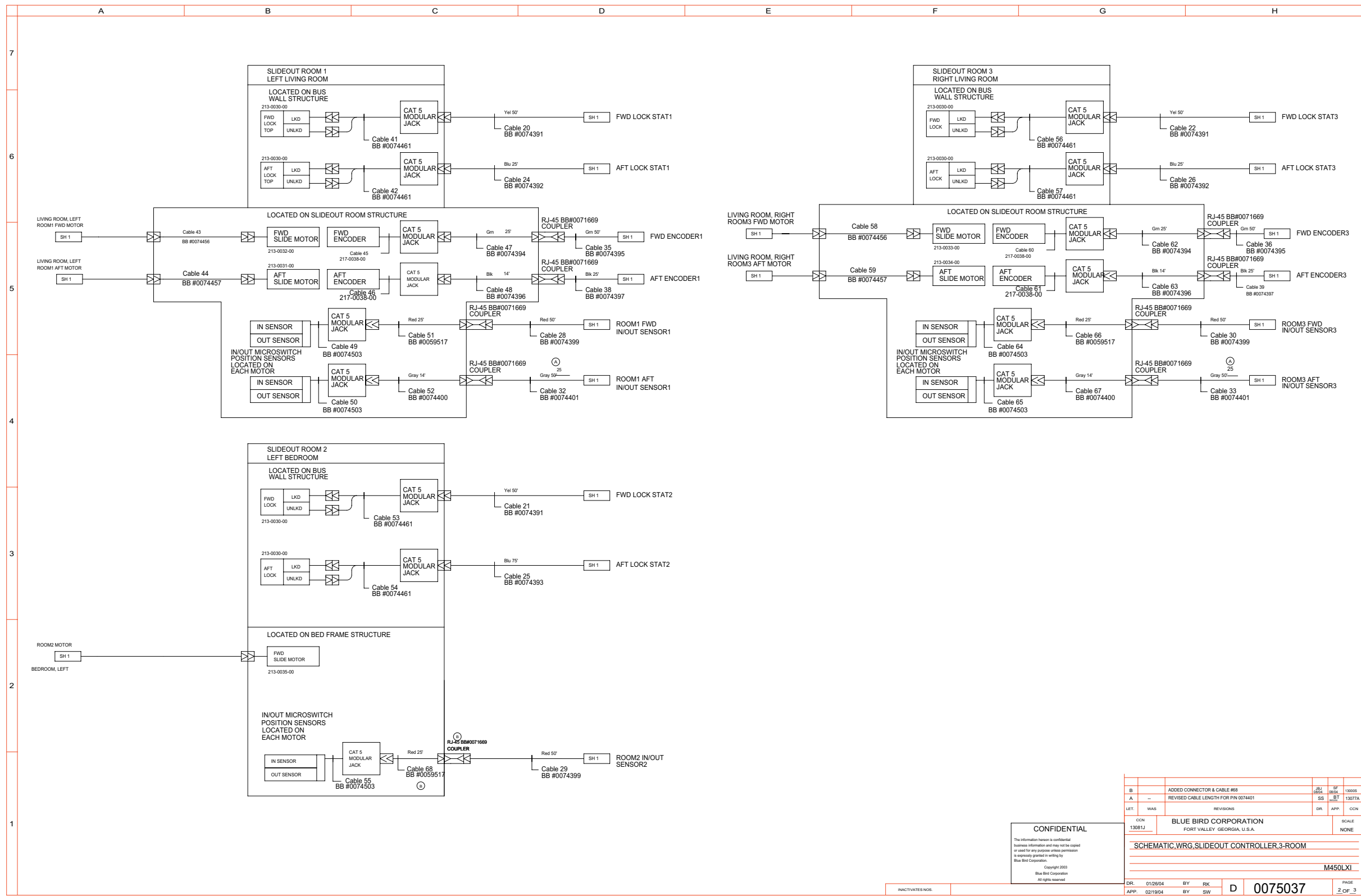

**CONFIDENTIAL**  
 This information is confidential and may not be copied or used for any purpose unless permission is expressly granted in writing by Blue Bird Corporation.  
 Copyright 2003  
 Blue Bird Corporation  
 All rights reserved.

CCN	13081J	BY	RK	SCALE	NONE
APP	02/1904	BY	SW	SCALE	NONE
BLUE BIRD CORPORATION FORT VALLEY, GEORGIA, U.S.A. SCHEMATIC, WRG, SLIDEOUT CONTROLLER, 3-ROOM M450LXI					
DR.	01/2904	BY	RK	D	0075037
APP.	02/1904	BY	SW		2 OF 3



Wiring Schematic 0075037 - Slide-Out Controller, 3 Room - Page 3 of 3

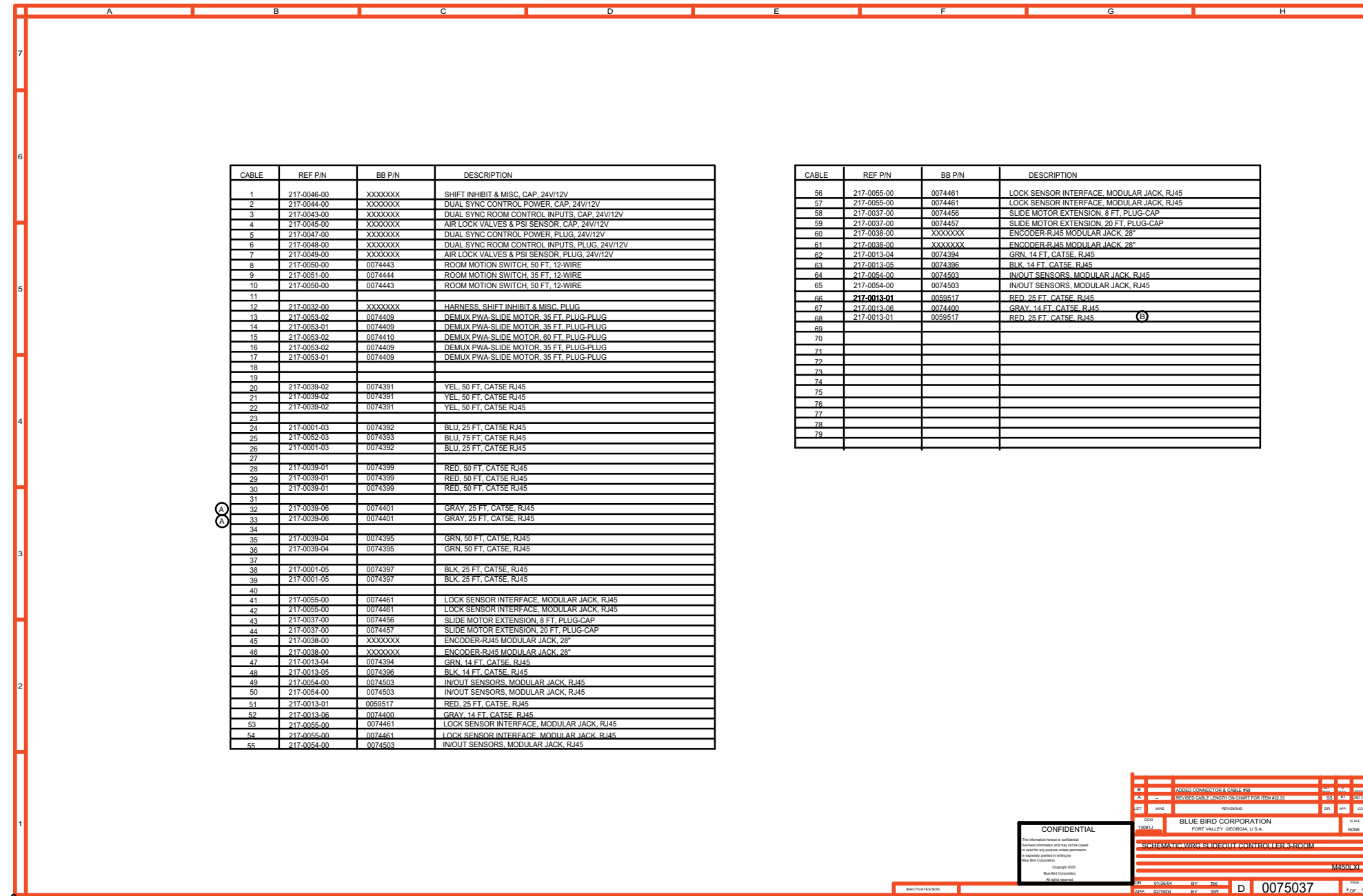

## Wiring Schematic 0076352 - EMS, Load Center, 120V

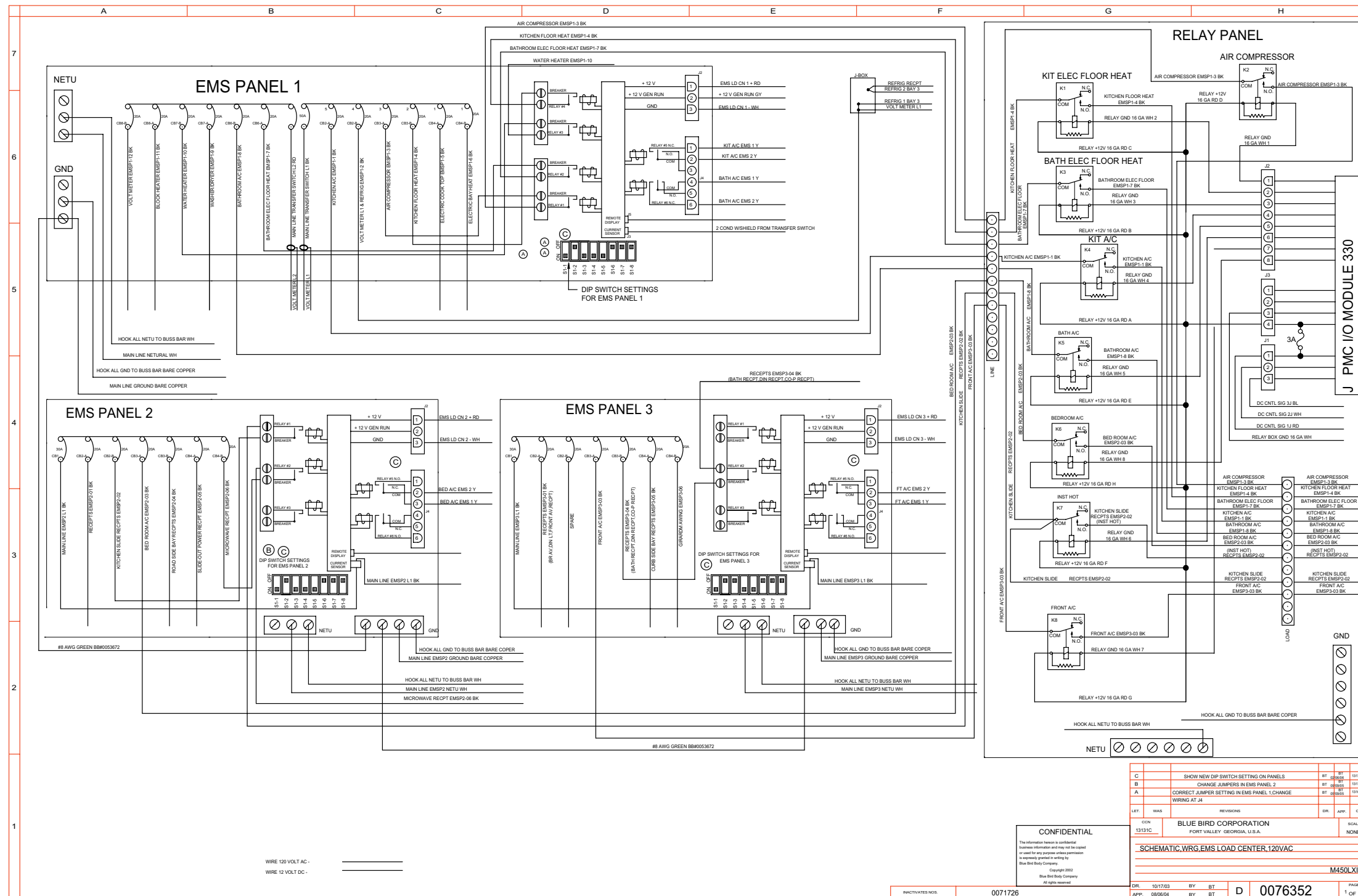

Wiring Schematic 0080496 - Auxiliary, 120V Inverter

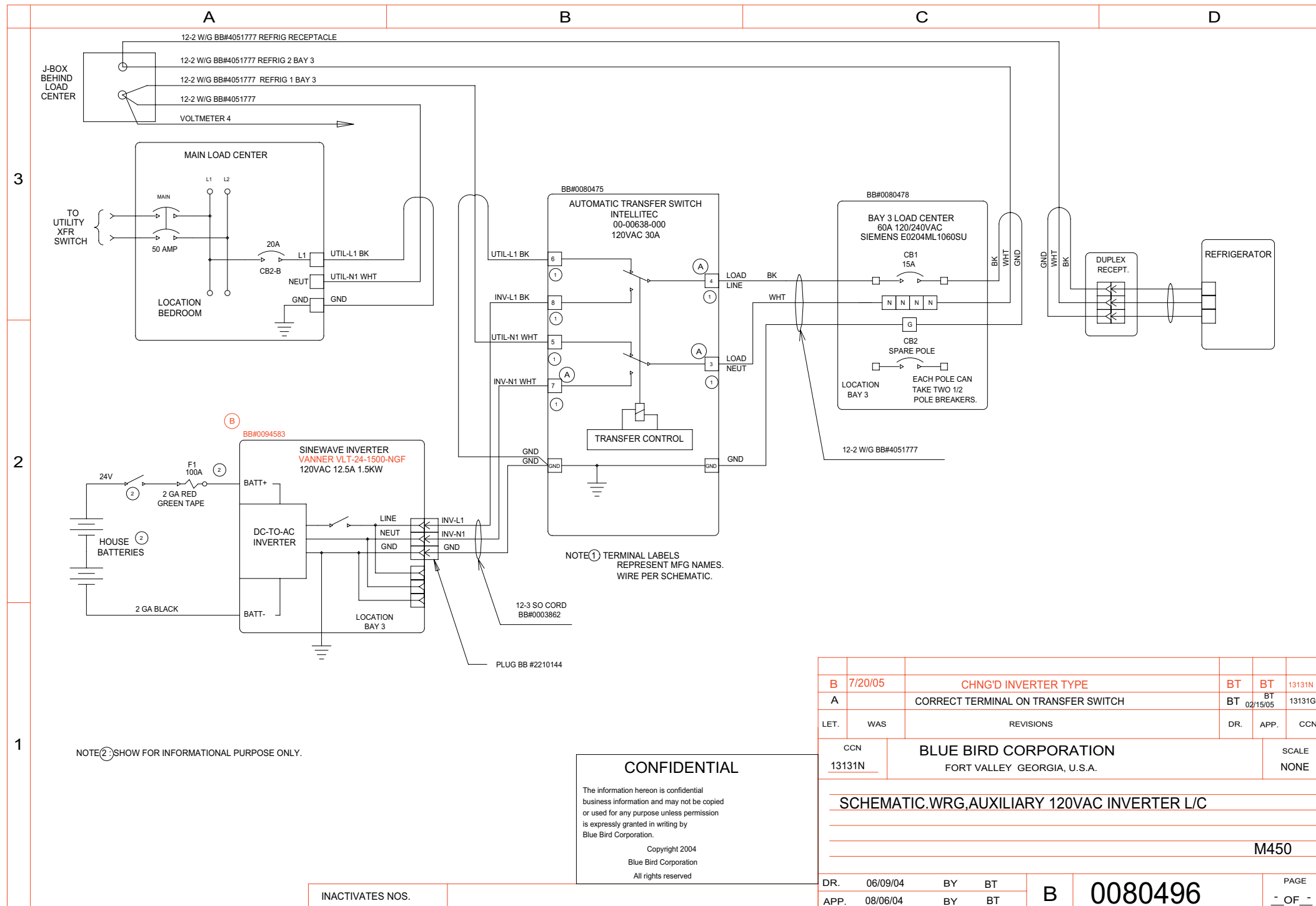

## Wiring Schematic 0075825 - Cable, Power Distribution

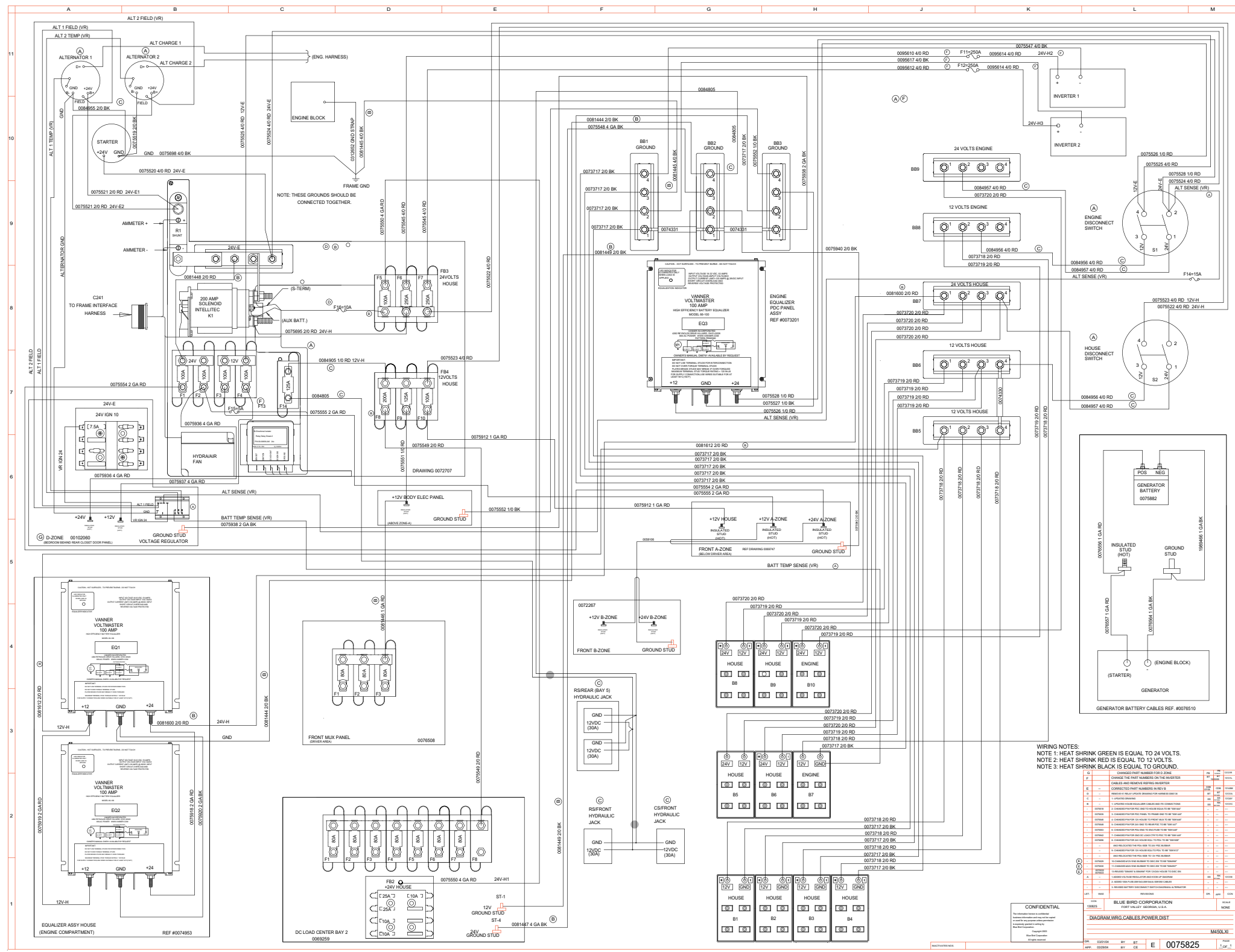

**WIRING NOTES:**  
 NOTE 1: HEAT SHRINK GREEN IS EQUAL TO 24 VOLTS.  
 NOTE 2: HEAT SHRINK RED IS EQUAL TO 12 VOLTS.  
 NOTE 3: HEAT SHRINK BLACK IS EQUAL TO GROUND.

SYMBOL	DESCRIPTION	REF.
F	CONNECT THE SHUNT NUMBER ON THE RESISTOR	14
E	CONNECTED SHUNT NUMBER IN RED'S	14
1	12VDC (30A)	14
2	24VDC (30A)	14
3	12VDC (30A)	14
4	24VDC (30A)	14
5	12VDC (30A)	14
6	24VDC (30A)	14
7	12VDC (30A)	14
8	24VDC (30A)	14
9	12VDC (30A)	14
10	24VDC (30A)	14
11	12VDC (30A)	14
12	24VDC (30A)	14
13	12VDC (30A)	14
14	24VDC (30A)	14
15	12VDC (30A)	14
16	24VDC (30A)	14
17	12VDC (30A)	14
18	24VDC (30A)	14
19	12VDC (30A)	14
20	24VDC (30A)	14
21	12VDC (30A)	14
22	24VDC (30A)	14
23	12VDC (30A)	14
24	24VDC (30A)	14
25	12VDC (30A)	14
26	24VDC (30A)	14
27	12VDC (30A)	14
28	24VDC (30A)	14
29	12VDC (30A)	14
30	24VDC (30A)	14
31	12VDC (30A)	14
32	24VDC (30A)	14
33	12VDC (30A)	14
34	24VDC (30A)	14
35	12VDC (30A)	14
36	24VDC (30A)	14
37	12VDC (30A)	14
38	24VDC (30A)	14
39	12VDC (30A)	14
40	24VDC (30A)	14
41	12VDC (30A)	14
42	24VDC (30A)	14
43	12VDC (30A)	14
44	24VDC (30A)	14
45	12VDC (30A)	14
46	24VDC (30A)	14
47	12VDC (30A)	14
48	24VDC (30A)	14
49	12VDC (30A)	14
50	24VDC (30A)	14

**CONFIDENTIAL**  
 BLUE BIRD CORPORATION  
 FORT VALLEY, GEORGIA, U.S.A.  
 DIAGRAM WIRING CABLES POWER.DIST  
 MESS.XI  
 0075825  
 3 of 3

Wiring Schematic 0075825 - Cable, Power Distribution - Exploded View A

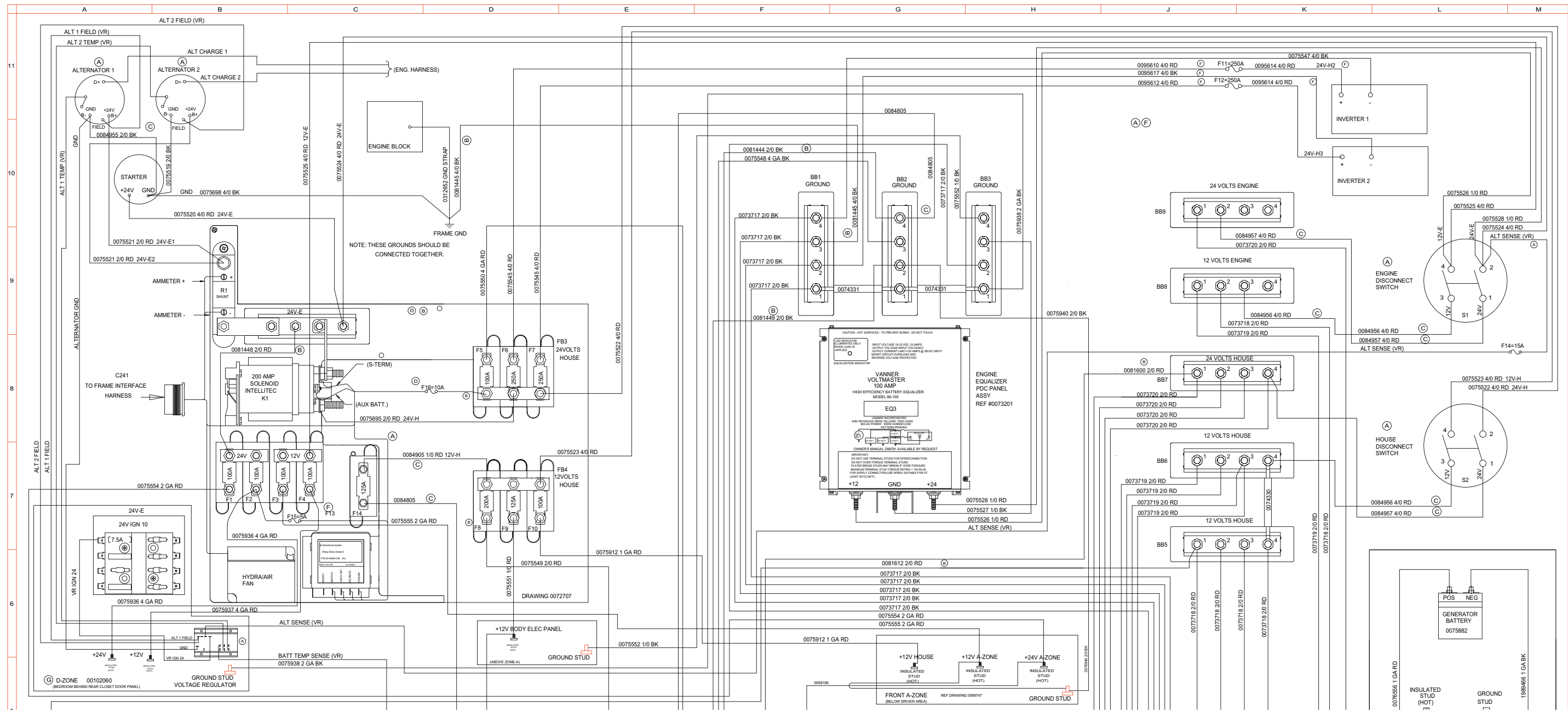

## Wiring Schematic 0075825 - Cable, Power Distribution - Exploded View B

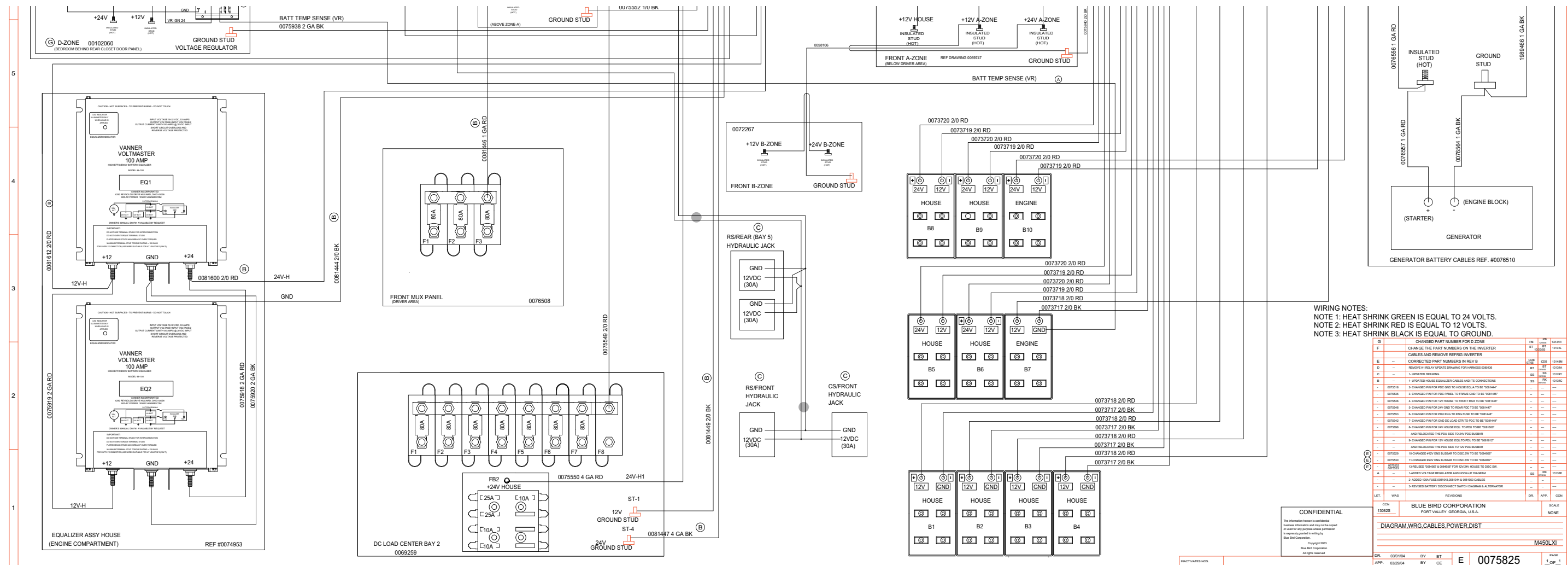

**WIRING NOTES:**  
 NOTE 1: HEAT SHRINK GREEN IS EQUAL TO 24 VOLTS.  
 NOTE 2: HEAT SHRINK RED IS EQUAL TO 12 VOLTS.  
 NOTE 3: HEAT SHRINK BLACK IS EQUAL TO GROUND.

REV	DESCRIPTION	DATE	BY	CHKD
0	CHANGED PART NUMBER FOR D ZONE			
1	CHANGE THE PART NUMBERS ON THE INVERTER			
2	CABLES AND REMOVE REPAIR INVERTER			
3	CORRECTED PART NUMBERS IN REV B			
4	REMOVED K1 RELAY UPDATE DRAWING FOR WIRING BUBBLE			
5	UPDATED DRAWING			
6	5 SPECIFIED HOUSE EQUALIZER CABLES AND ITS CONNECTIONS			
7	3 CHANGED PWR FOR PDC GND TO HOUSE GND TO BE "HOUSE"			
8	3 CHANGED PWR FOR PDC PANEL TO FRAME GND TO BE "HOUSE"			
9	3 CHANGED PWR FOR 12V HOUSE TO HOUSE GND TO BE "HOUSE"			
10	3 CHANGED PWR FOR 24V GND TO BE "HOUSE"			
11	3 CHANGED PWR FOR POLV GND TO ENG FUSE TO BE "HOUSE"			
12	3 CHANGED PWR FOR GND DC LOAD CTR TO PDC TO BE "HOUSE"			
13	3 CHANGED PWR FOR 24V HOUSE GND TO PDC TO BE "HOUSE"			
14	AND RELOCATED THE POLV GND TO 24V PDC BUSBAR			
15	3 CHANGED PWR FOR 12V HOUSE GND TO POLV TO BE "HOUSE"			
16	AND RELOCATED THE POLV GND TO 24V PDC BUSBAR			
17	3 CHANGED PWR FOR 24V HOUSE GND TO POLV TO BE "HOUSE"			
18	11 CHANGED HWY ENG BUSBAR TO 24V GND TO BE "HOUSE"			
19	13 RELEASED "HOUSE" A BATTERY FOR HOUSE GND TO 24V GND			
20	14 ADDED VOLT REGULATOR AND HOOK UP DRAWING			
21	3 ADDED 100A FUSE ON 24V HOUSE & 200A FUSE ON 12V HOUSE			
22	3 REVISED BATTERY DISCONNECT SWITCH DIAGRAM & ALTERNATOR			

**CONFIDENTIAL**  
 BLUE BIRD CORPORATION  
 FORT VALLEY, GEORGIA, U.S.A.  
 DIAGRAM.WRG.CABLES.POWER.DIST.  
 M450LXI  
 DR: 03/10/04 BY: BT  
 APP: 03/28/04 BY: CE  
 SCALE: NONE  
 DATE: 03/28/04  
 PART: 0075825  
 PAGE: 1 OF 1

Wiring Schematic 0070060 - Dataloops

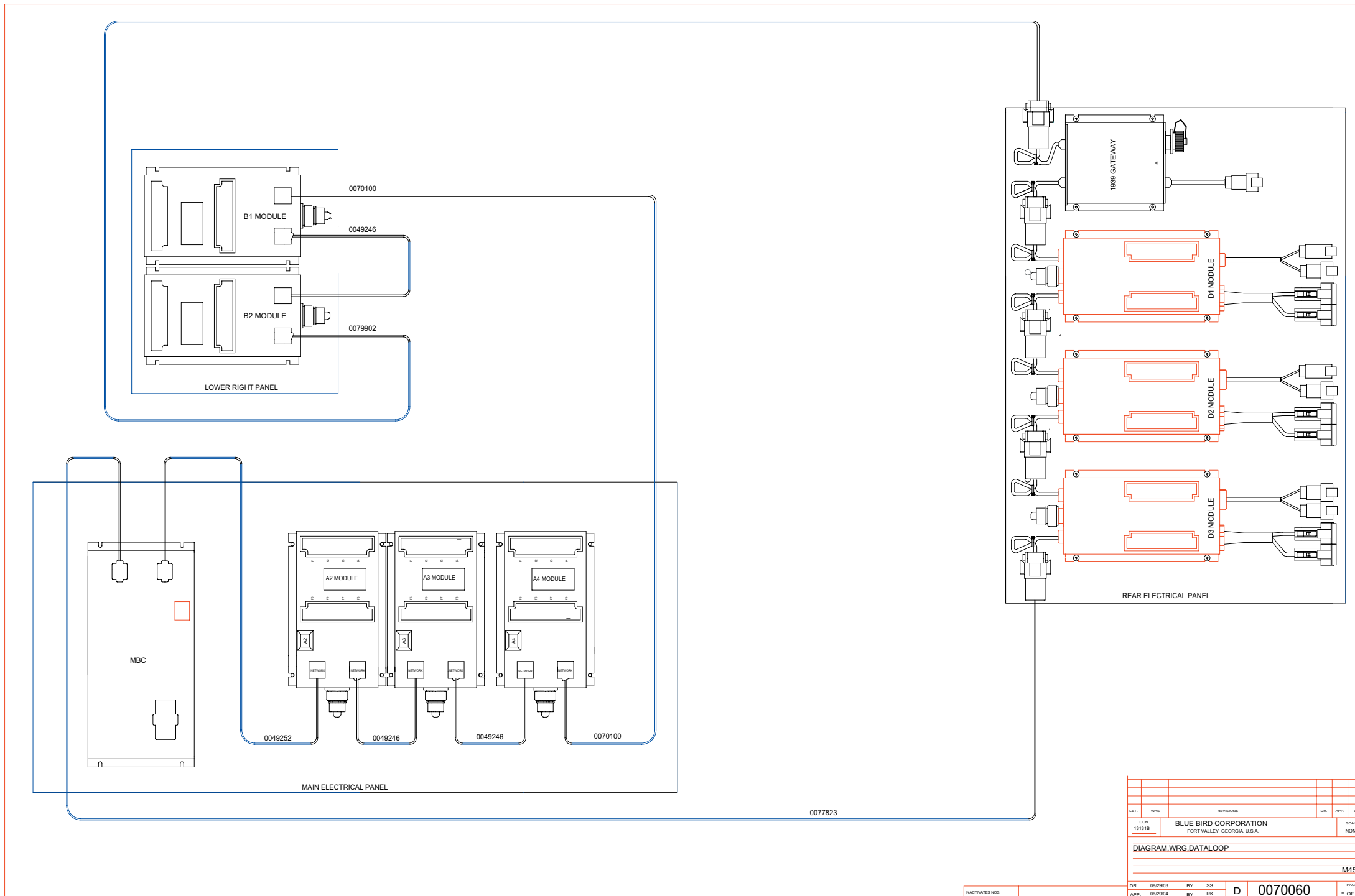

LET	WAS	REVISIONS	DEL	APP	CCN
CON	13131B	BLUE BIRD CORPORATION FORT VALLEY, GEORGIA, U.S.A.			SCALE NONE
DIAGRAM.WRG.DATALOOP					M450
DR	06/29/03	BY SS			PAGE
APP	06/29/04	BY RK	D	0070060	- OF -

Wiring Schematic 0075601 - Front, A/V

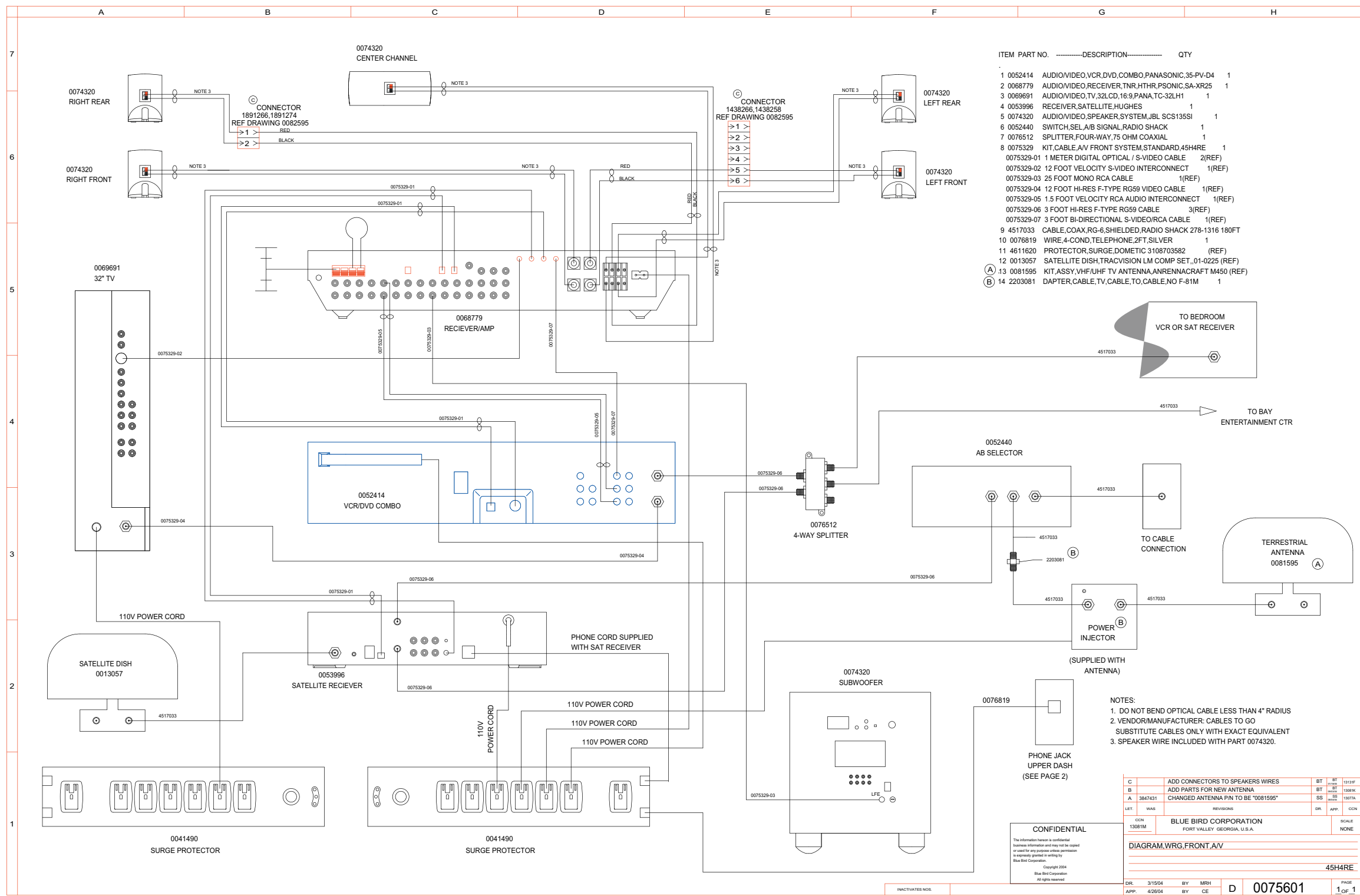



Wiring Schematic 0091200 - 120Vac, Power Distribution, W/EMS, Floorplan A - Page 1 of 2

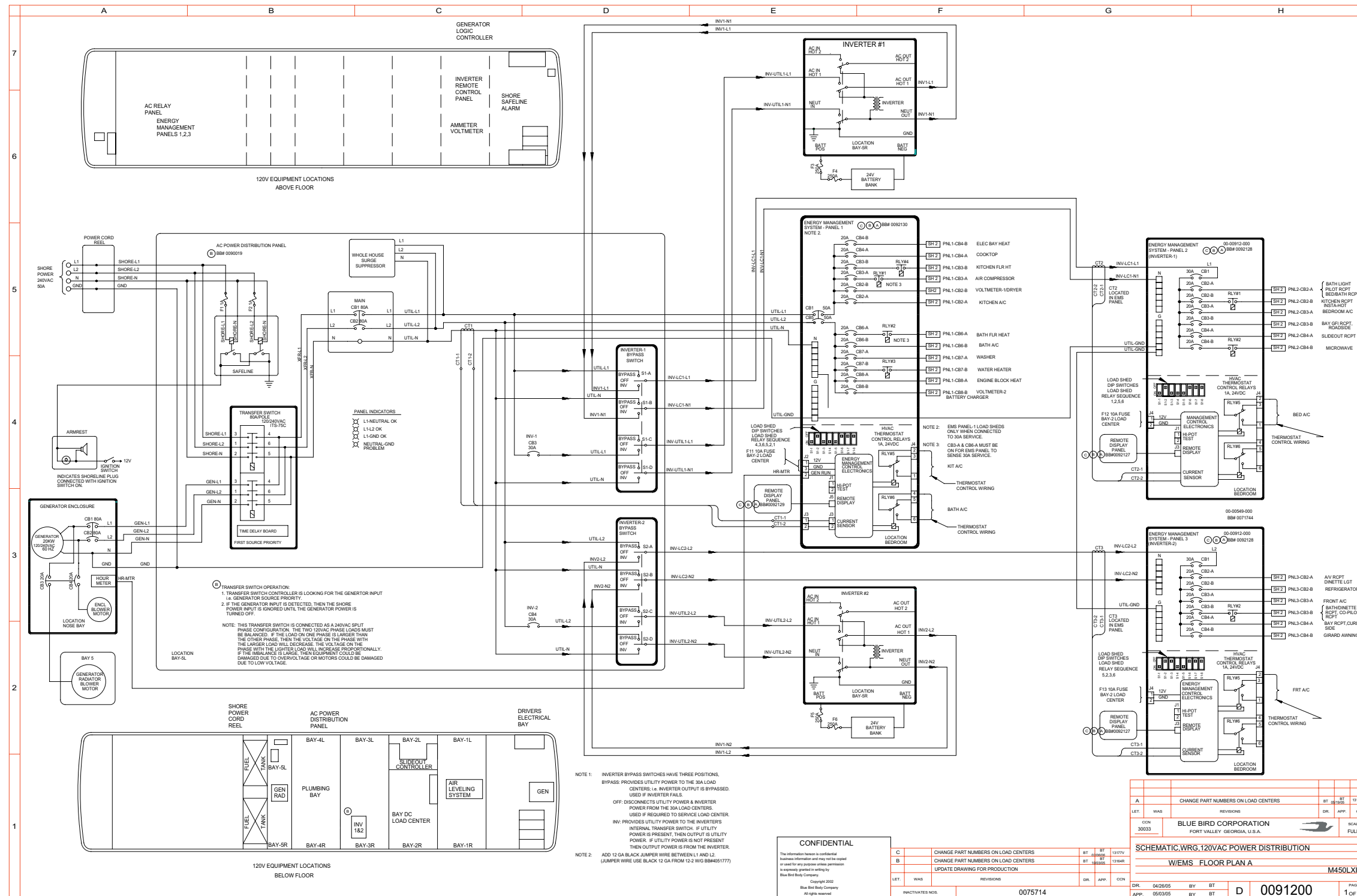

**CONFIDENTIAL**  
The information herein is confidential business information and may not be copied or used for any purpose unless permission is expressly granted in writing by Blue Bird Body Company.  
Copyright 2002  
Blue Bird Body Company  
All rights reserved.

C.	CHANGE PART NUMBERS ON LOAD CENTERS	BT	BT	1317V	
B	CHANGE PART NUMBERS ON LOAD CENTERS	BT	BT	1316AR	
UPDATE DRAWING FOR PRODUCTION					
LET.	WAS	REVISIONS	DR.	APP.	CCN
LET.	WAS	REVISIONS	DR.	APP.	CCN
INACTIVATES NOS.					
0075714					

CHANGE PART NUMBERS ON LOAD CENTERS					BT	BT	1316AR
CHANGE PART NUMBERS ON LOAD CENTERS					BT	BT	1316AR
UPDATE DRAWING FOR PRODUCTION							
SCHEMATIC.WRG.120VAC POWER DISTRIBUTION							
WEMS_FLOOR PLAN A					M450LXI		
DL	042655	BY	BT	D	0091200	PAGE	1 OF 2
APP.	050305	BY	BT				

Wiring Schematic 0091200 - 120Vac, Power Distribution, W/EMS, Floorplan A - Page 2 of 2

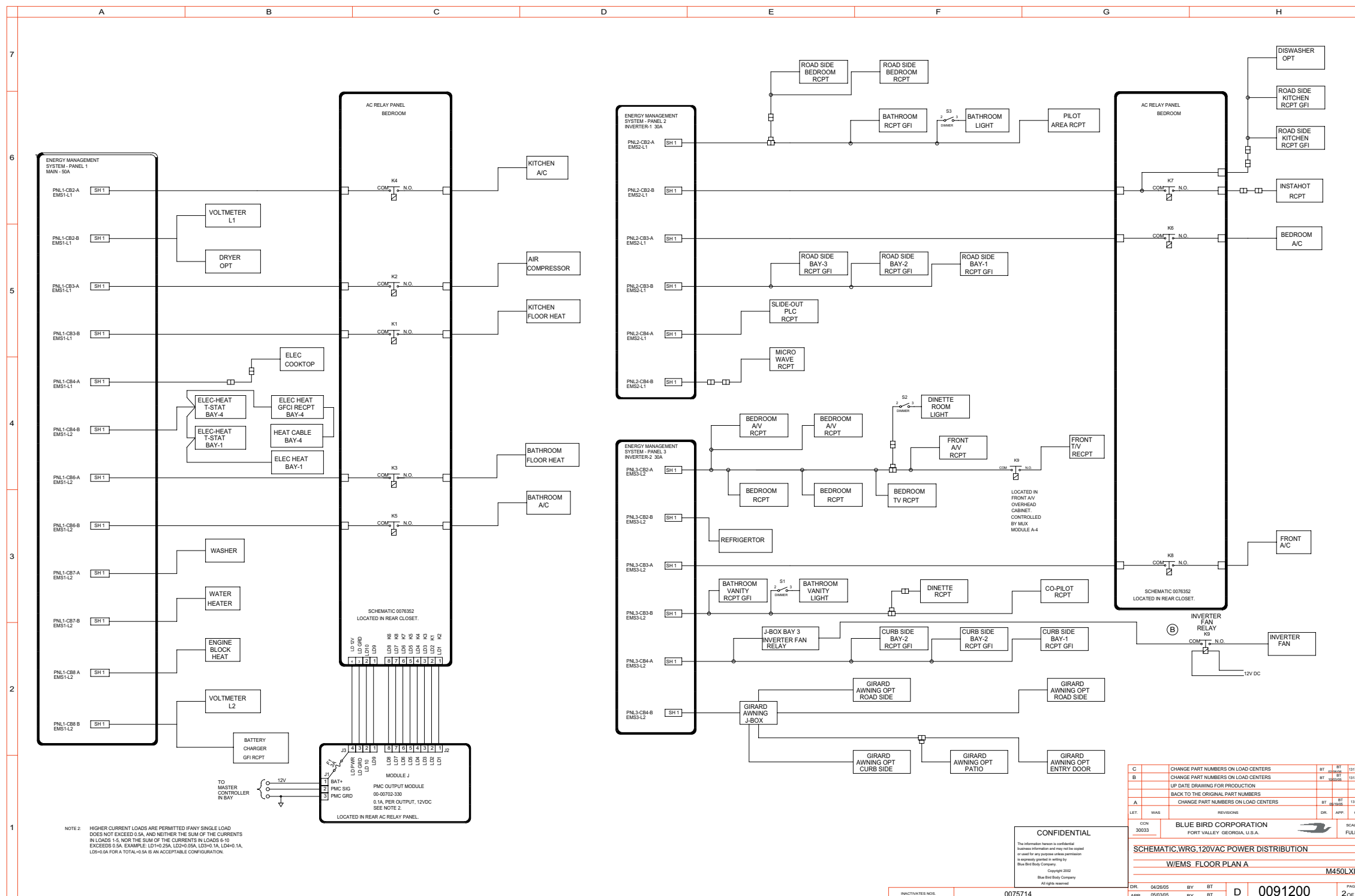

Wiring Schematic 0074465 - Power Distribution, DC

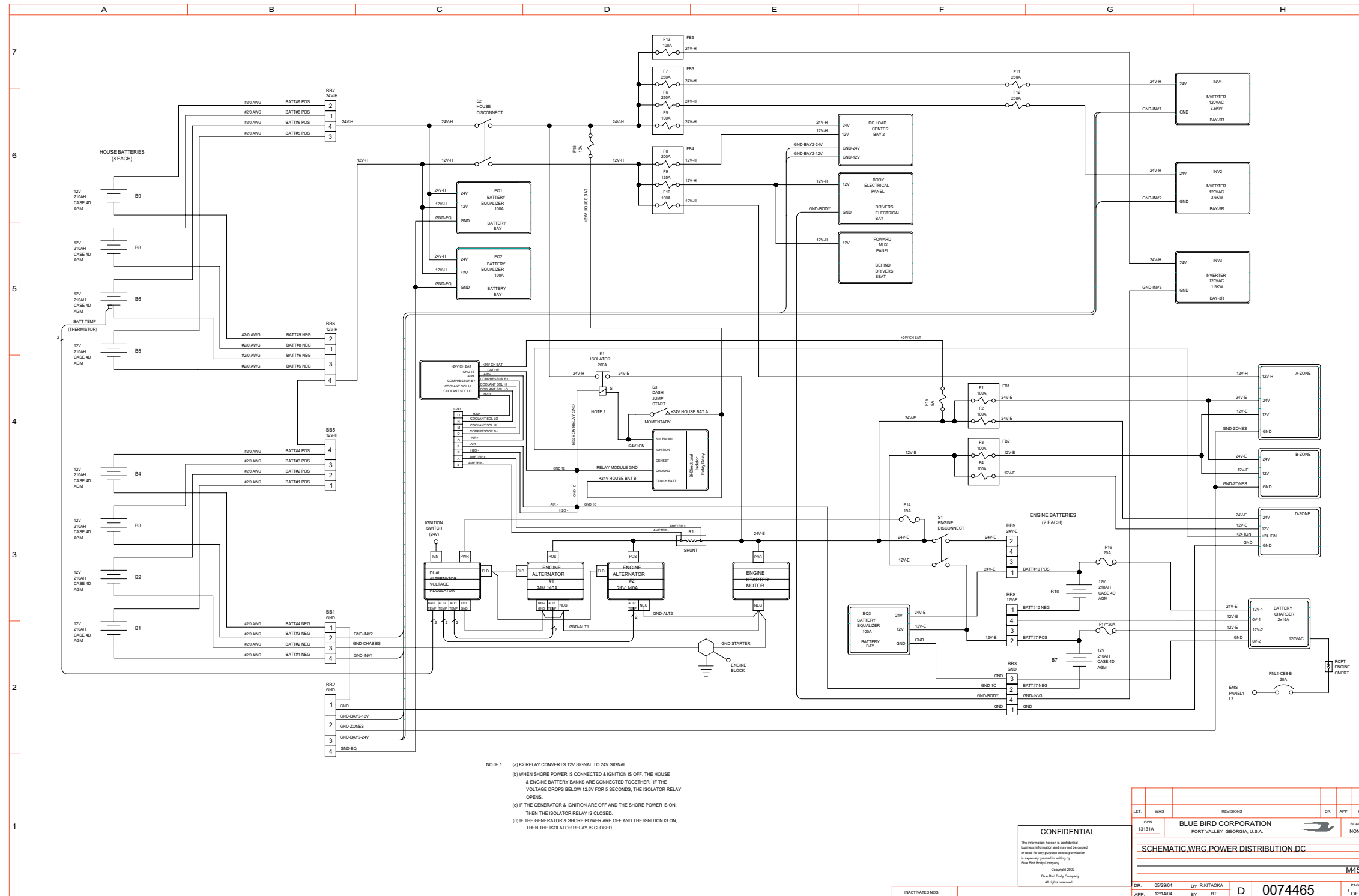

## Wiring Schematic 0075600 - Rear A/V

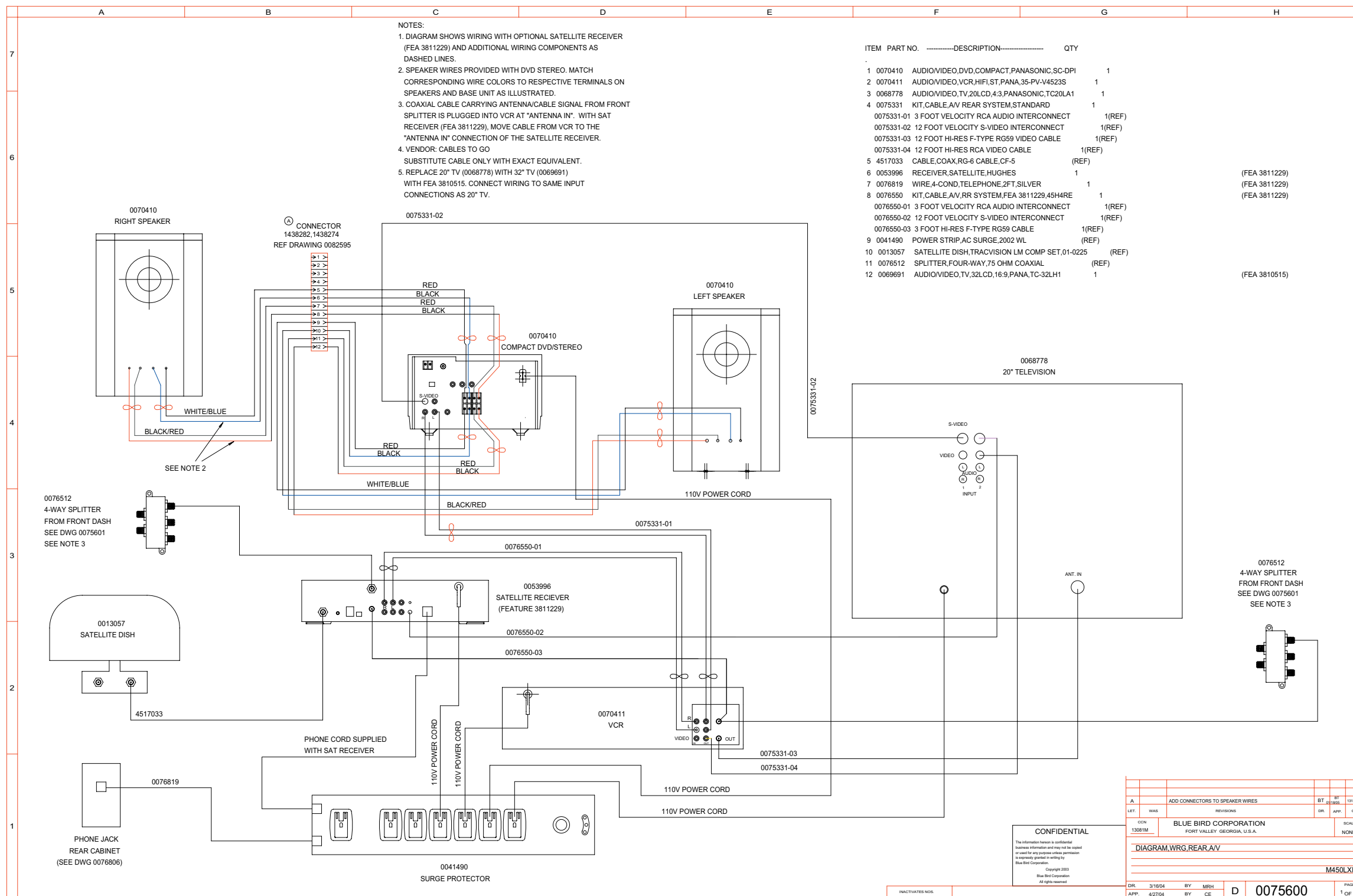

Wiring Schematic 0076919- Onstar Communication

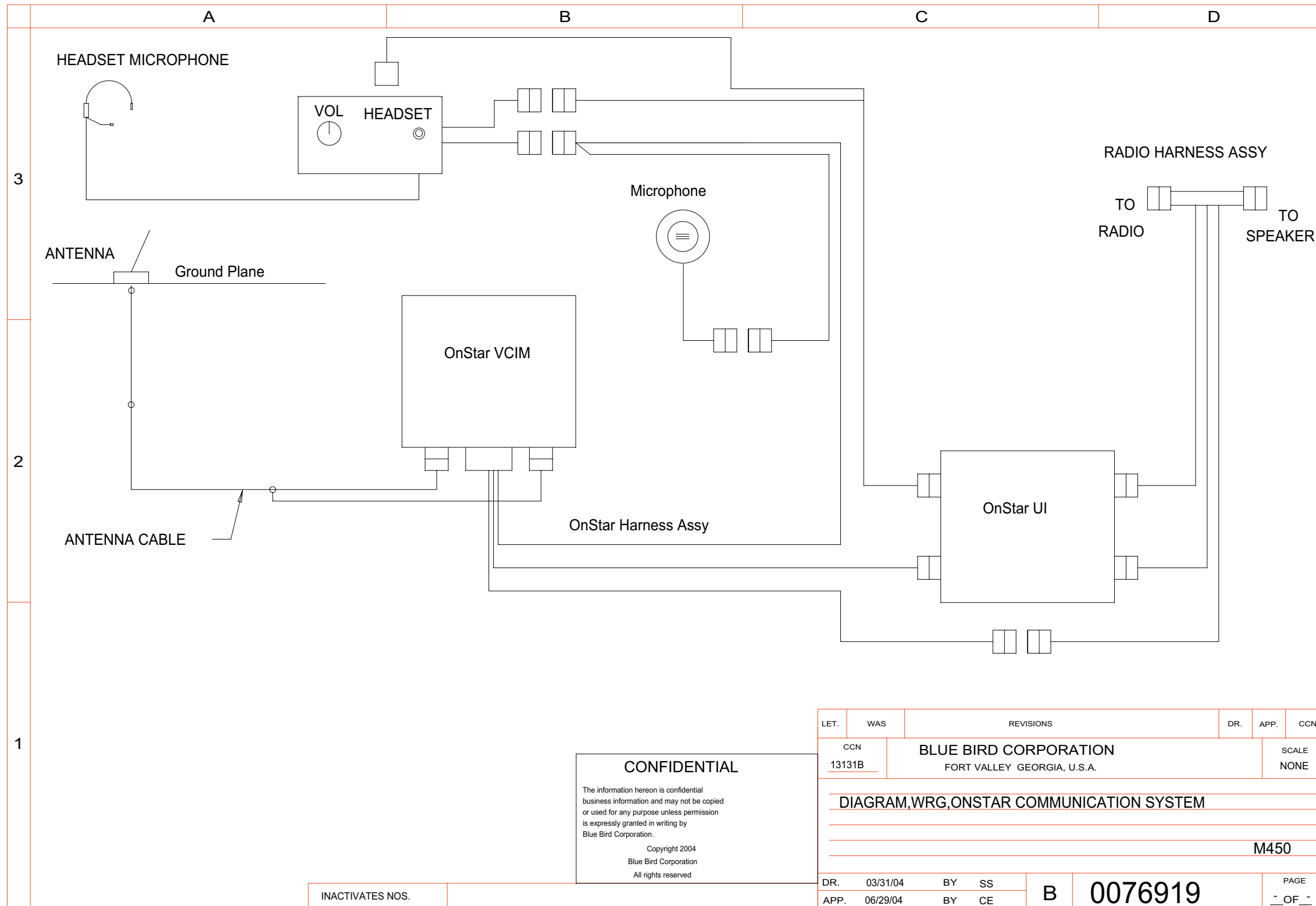

**CONFIDENTIAL**

The information hereon is confidential business information and may not be copied or used for any purpose unless permission is expressly granted in writing by Blue Bird Corporation.

Copyright 2004  
Blue Bird Corporation  
All rights reserved

LET.	WAS	REVISIONS	DR.	APP.	CCN
CCN	13131B	<b>BLUE BIRD CORPORATION</b> FORT VALLEY GEORGIA, U.S.A.			SCALE NONE
<b>DIAGRAM, WRG, ONSTAR COMMUNICATION SYSTEM</b>					
<b>M450</b>					
DR.	03/31/04	BY SS	<b>B</b>	<b>0076919</b>	PAGE
APP.	06/29/04	BY CE			OF

INACTIVATES NOS.

## Wiring Schematic 0078105 - Luggage Comp 1

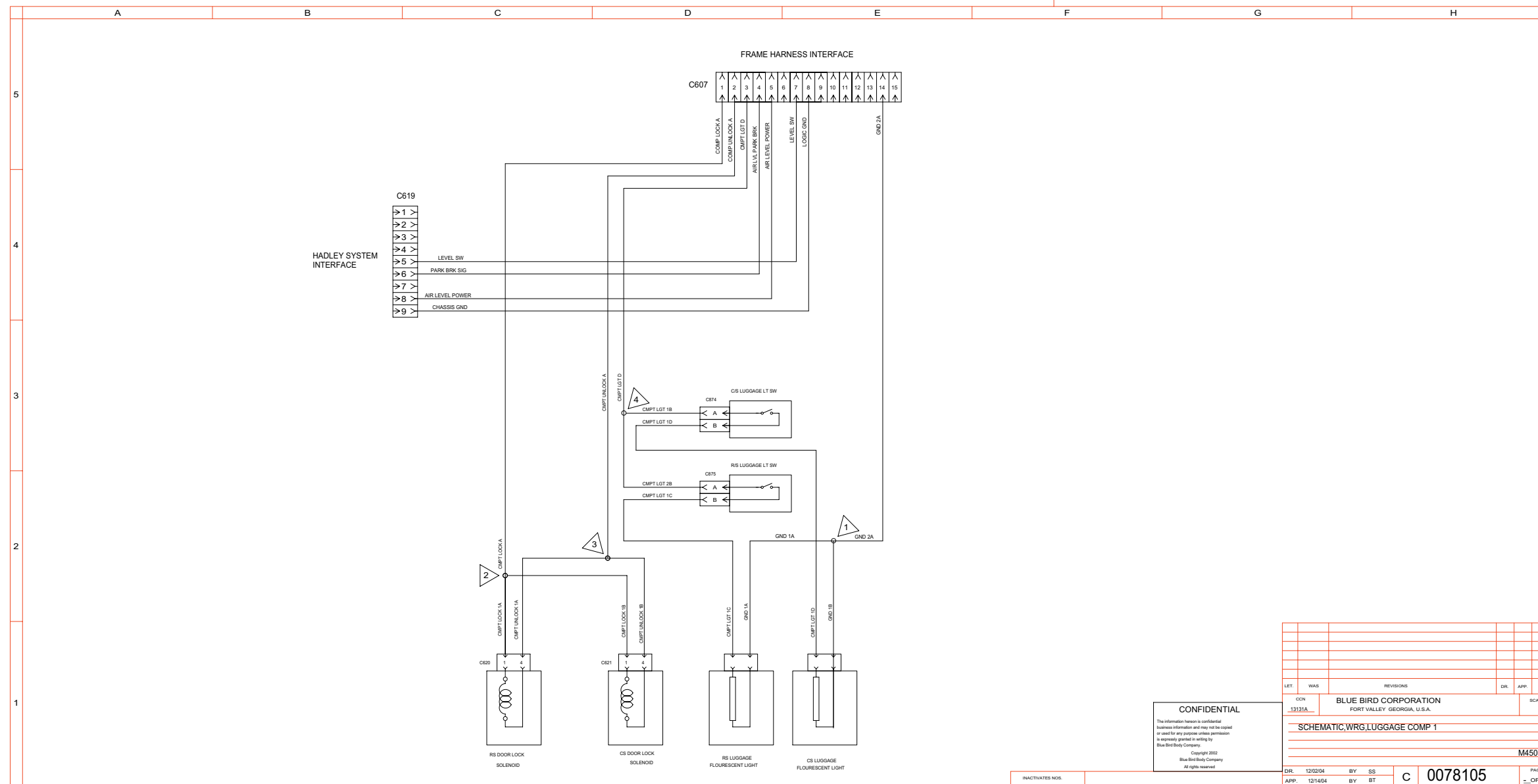

**CONFIDENTIAL**  
 The information herein is confidential business information and may not be copied or used for any purpose without permission in expressly granted in writing by Blue Bird Body Company.  
 Copyright 2002 Blue Bird Body Company  
 All rights reserved.

LET.	WAS	REVISIONS	DR.	APP.	CCN
CCN	13131A				
BLUE BIRD CORPORATION FORT VALLEY, GEORGIA, U.S.A.					
SCHEMATIC, WRG, LUGGAGE COMP 1					
M450					
DR.	12/22/04	BY	SS		
APP.	12/14/04	BY	BT	c	0078105
					PAGE
					- OF -

Wiring Schematic 0080226 - Luggage Comp 2

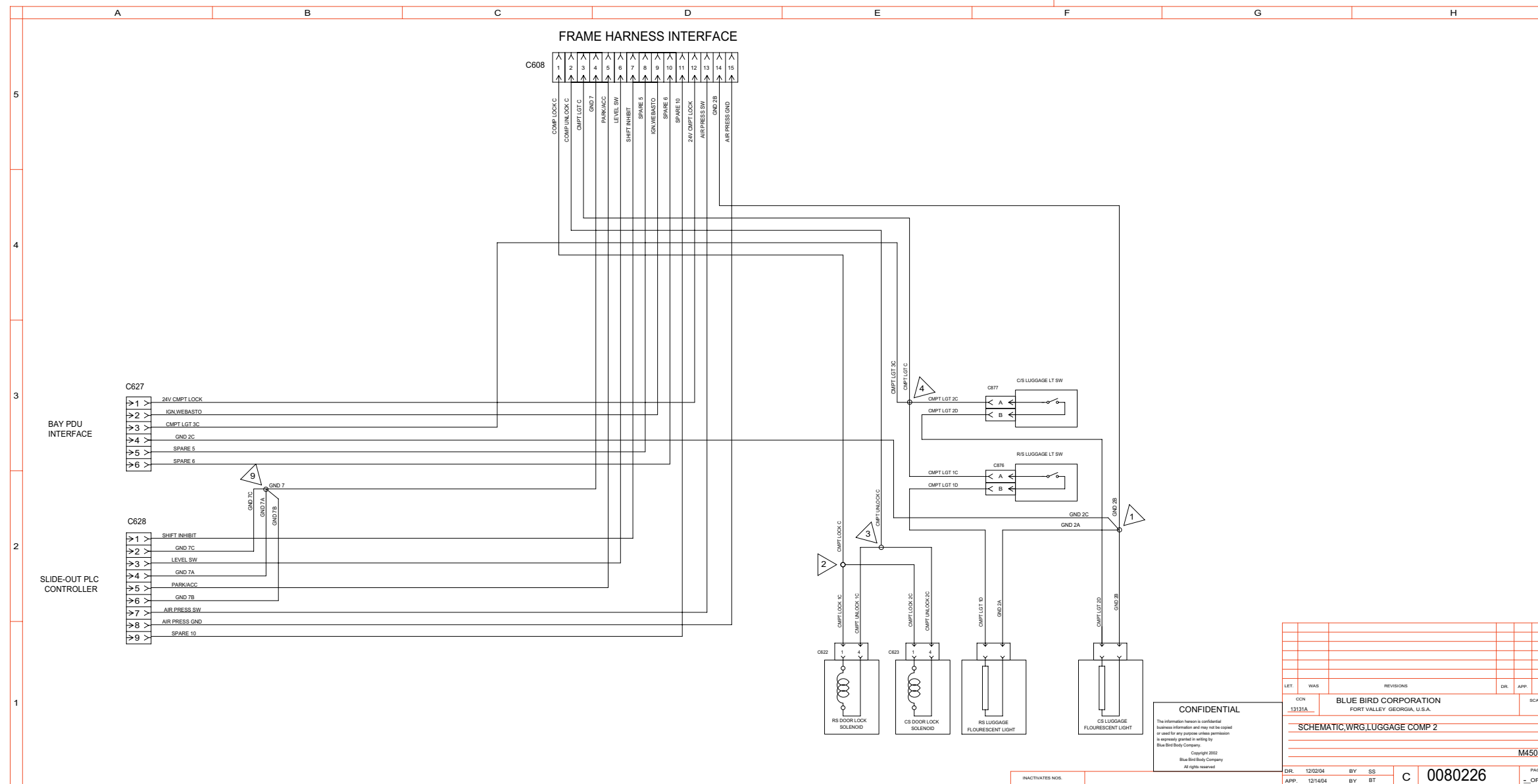

## Wiring Schematic 0081265 - Luggage Comp 3

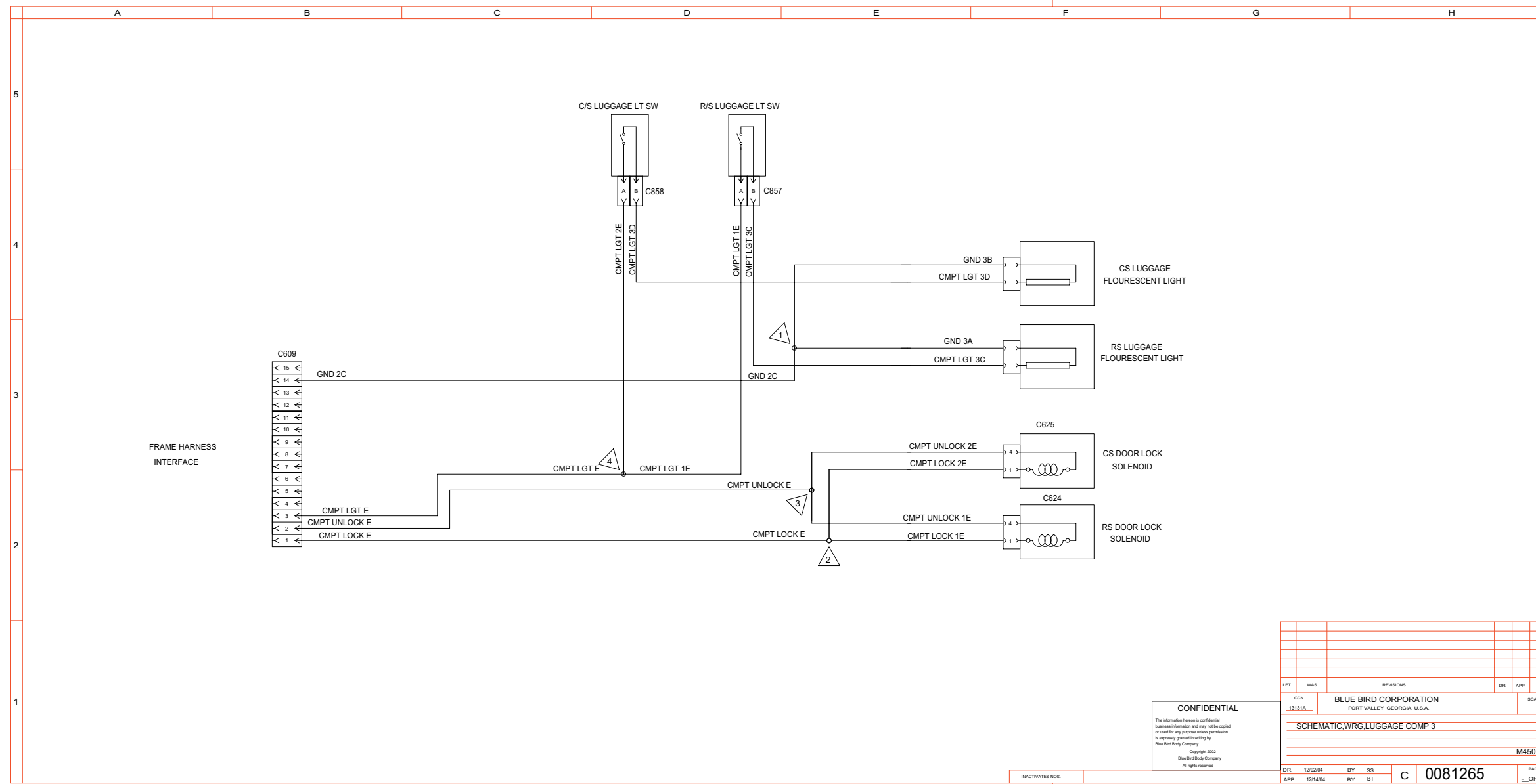



Wiring Schematic 0082266 - Luggage Comp. 4

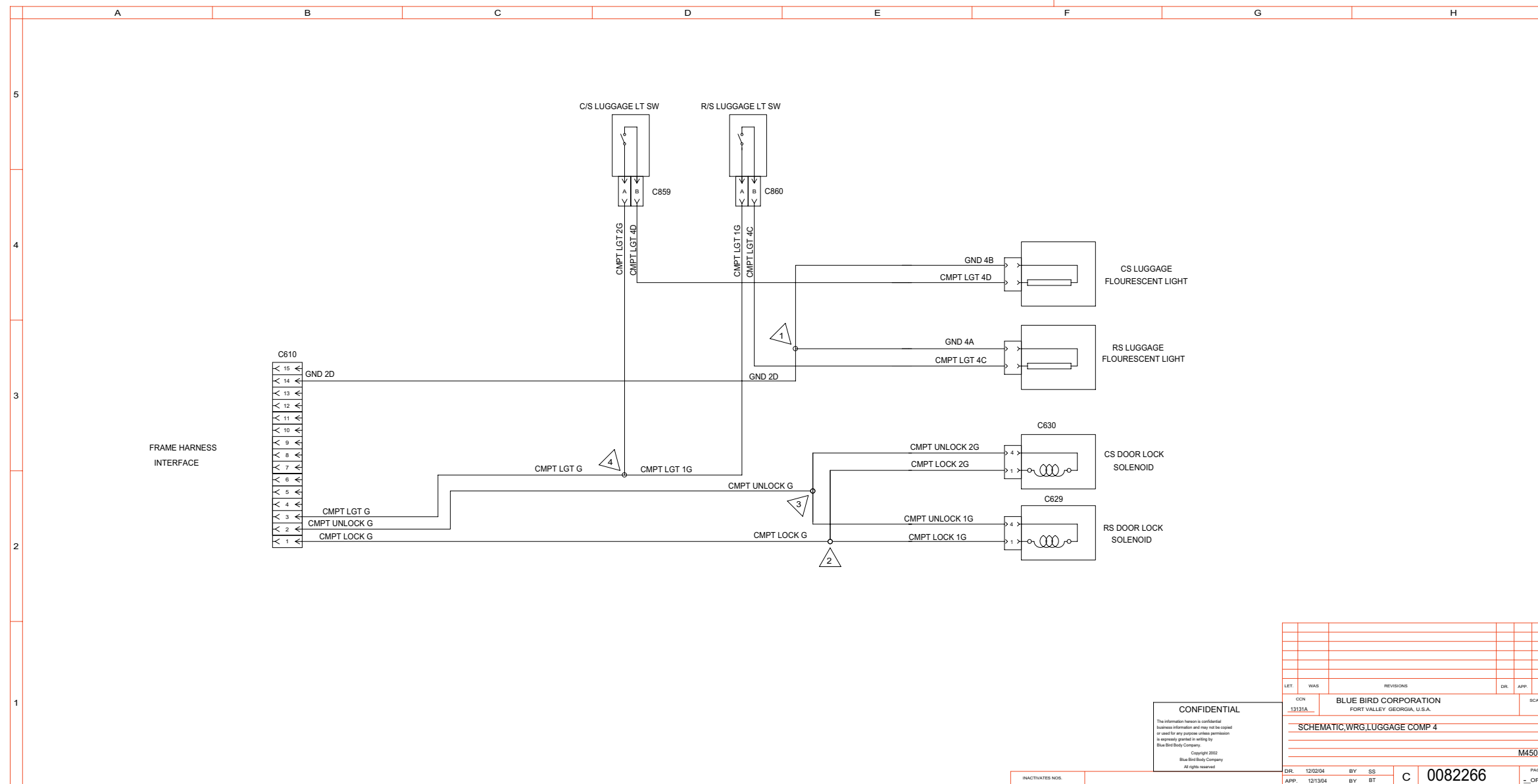

Wiring Schematic 0084199 - Luggage Comp 5

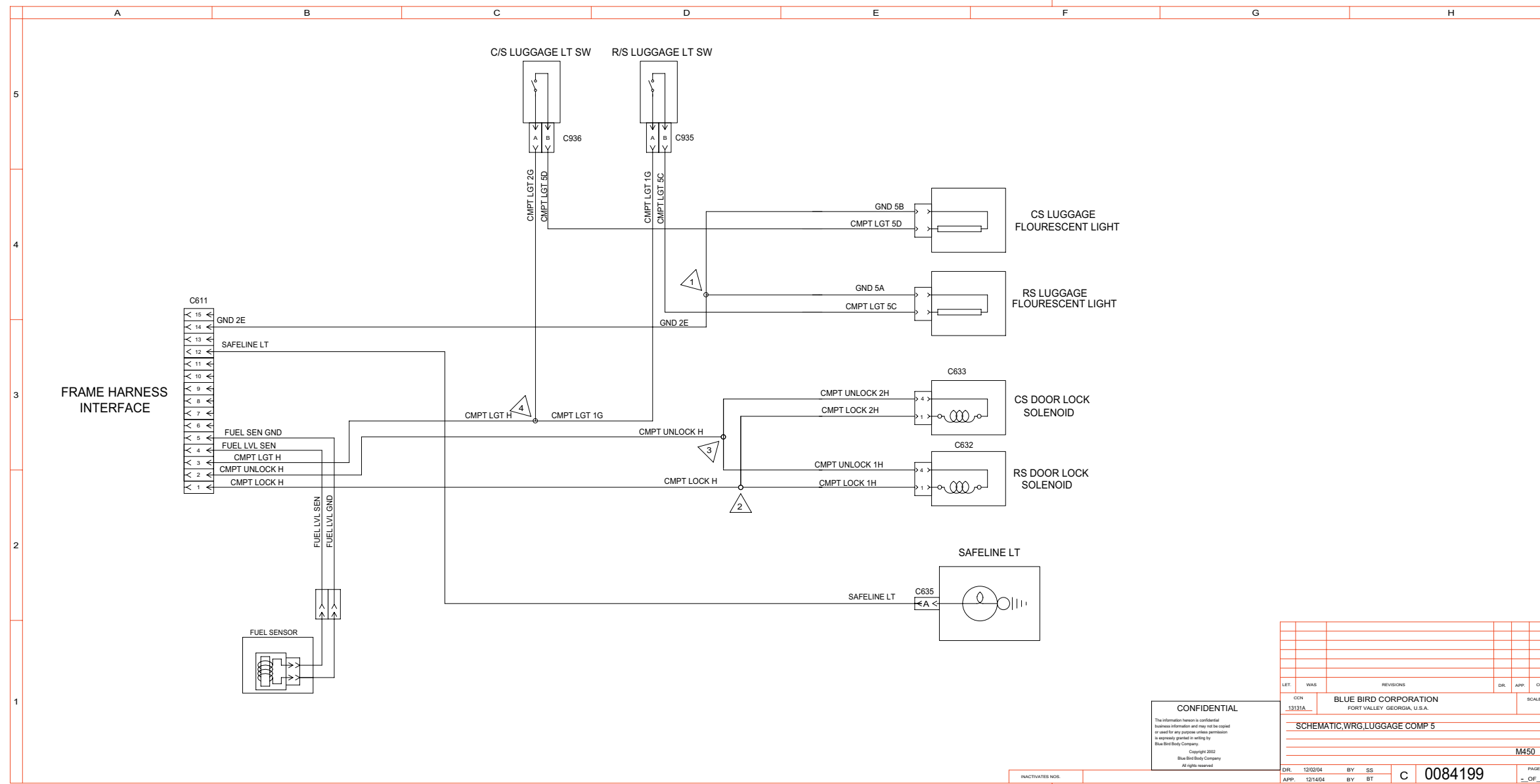

LET	WAS	REVISIONS	DIR	APP	CCN

CCN 13331A BLUE BIRD CORPORATION FORT VALLEY GEORGIA, U.S.A. SCALE

SCHEMATIC, WRG, LUGGAGE COMP 5

M450

DIR: 12/02/04 BY: SS C 0084199 PAGE

APP: 12/14/04 BY: BT - OF -

Wiring Schematic 0086141 - Dash/A/C/Controls

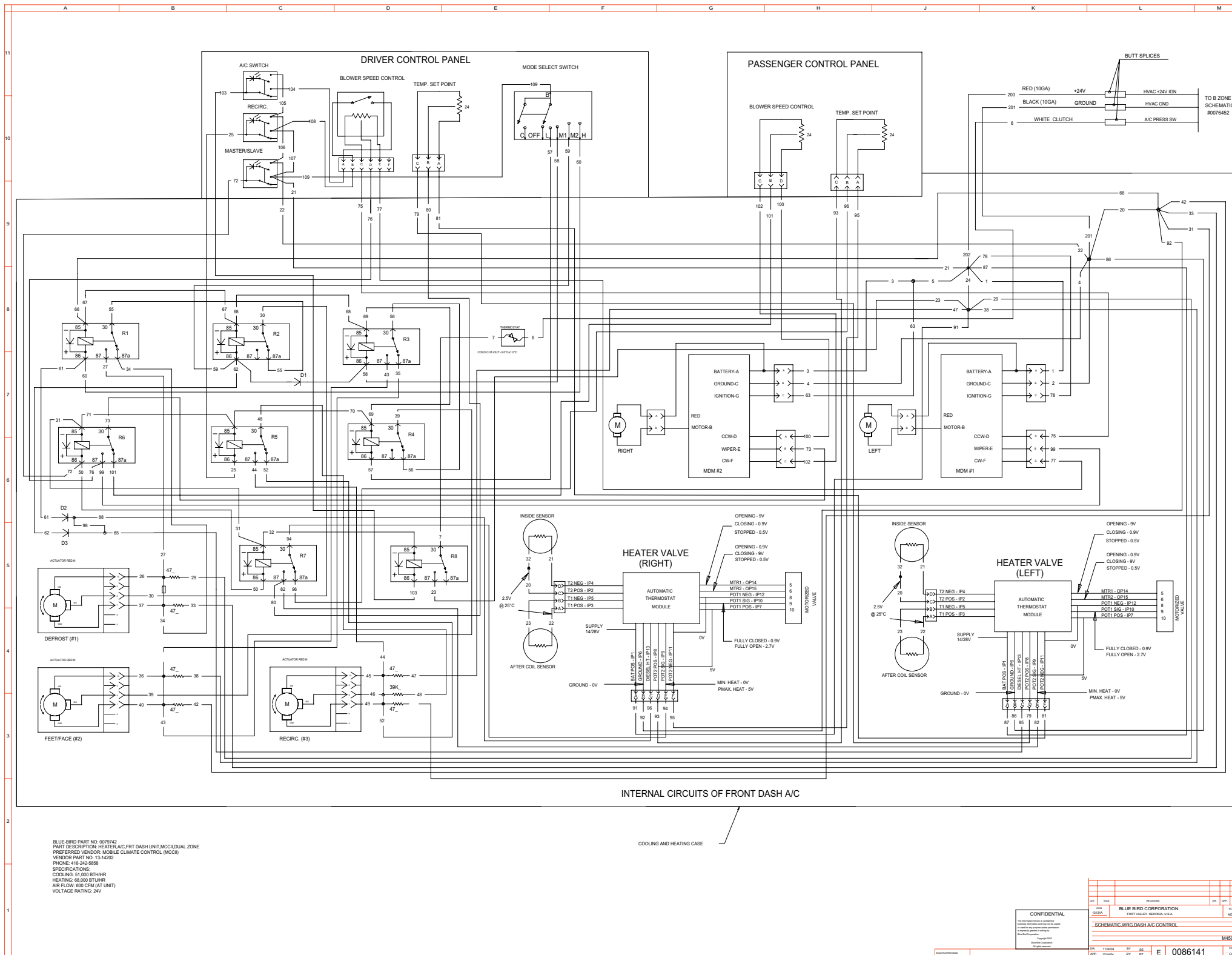

Wiring Schematic 0086141 - Dash/A/C/Controls - Exploded View A

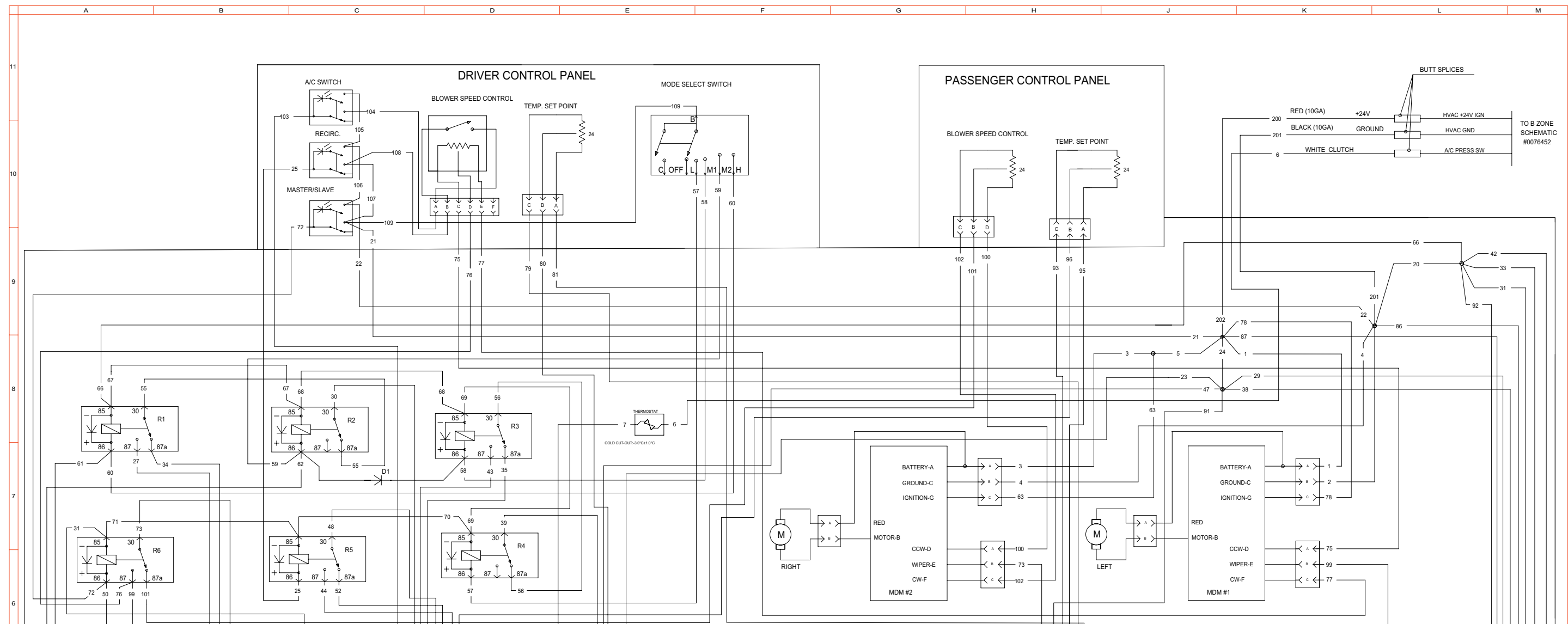

Wiring Schematic 0086141 - Dash / AC Controls

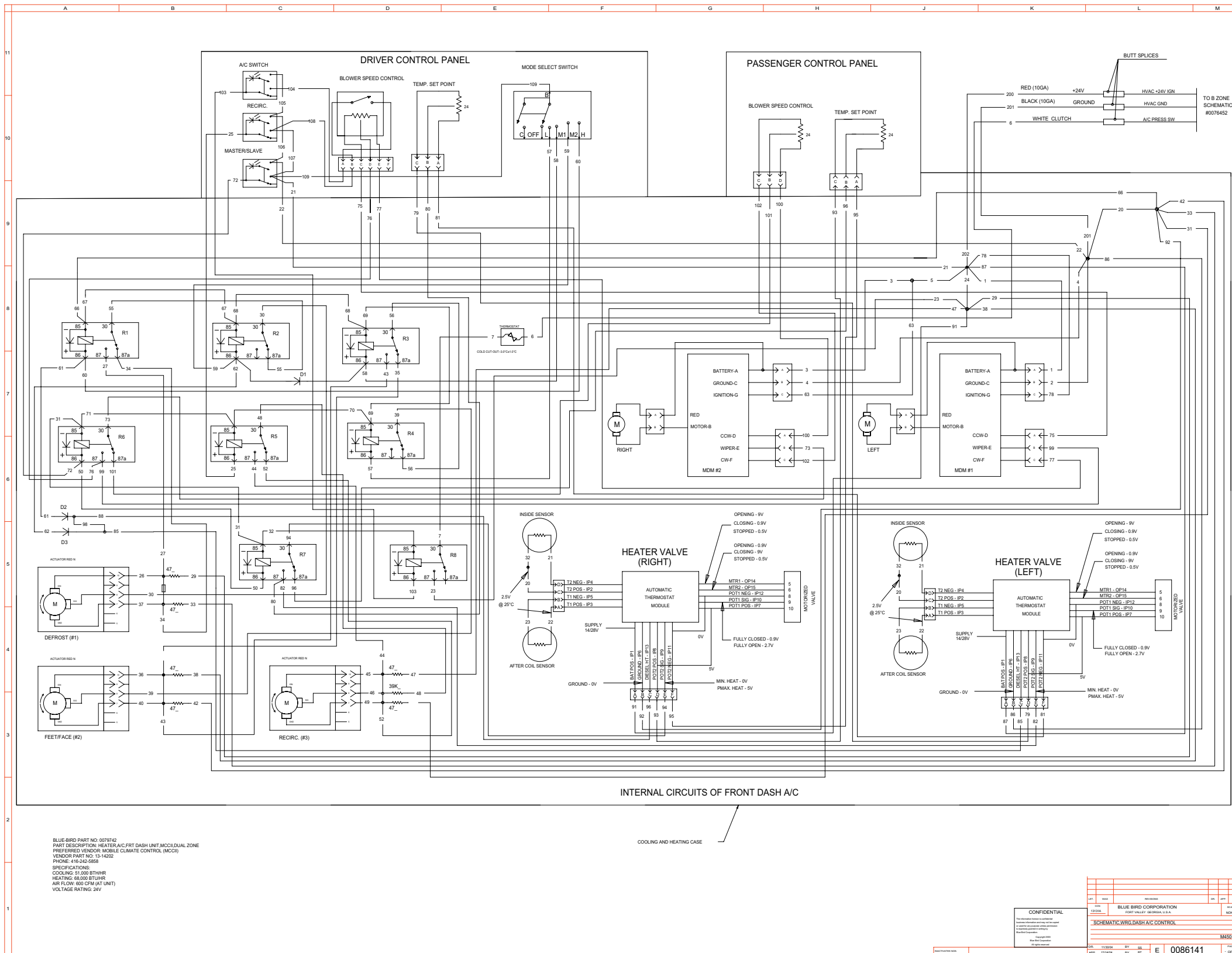

## Wiring Schematic 0078072 - Tail Lights

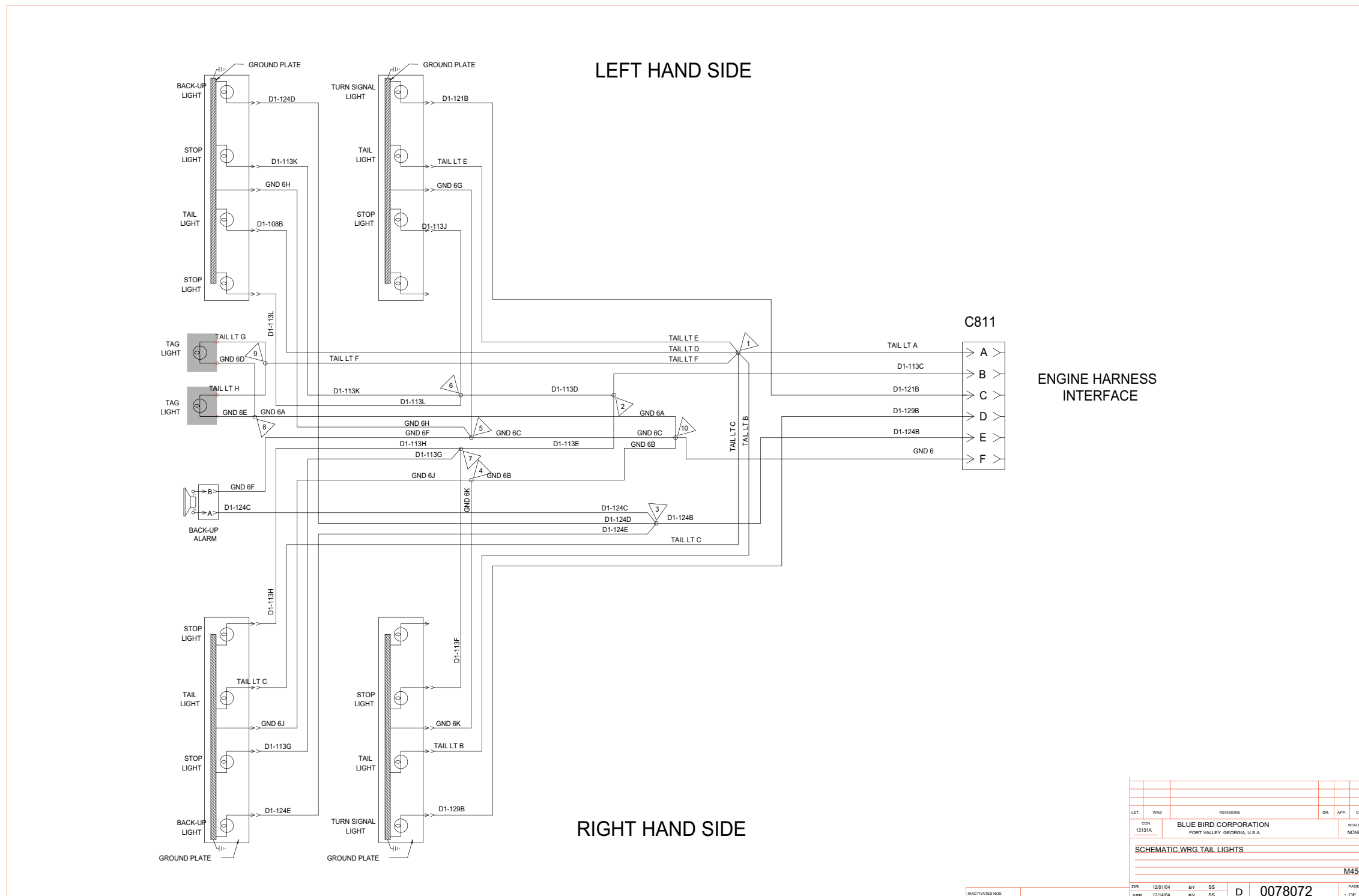

Wiring Schematic 0075992 - Transmission

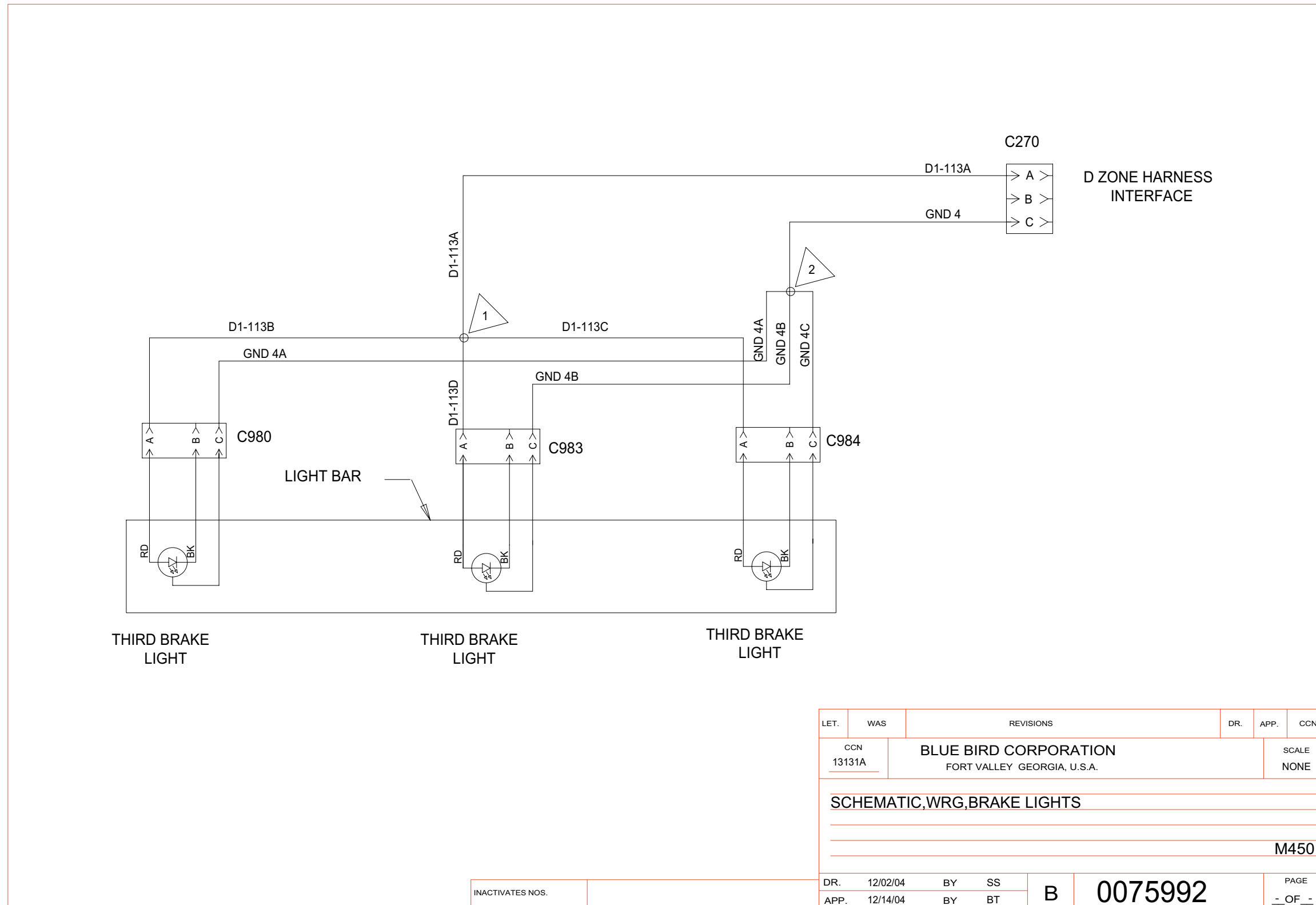

LET.	WAS	REVISIONS	DR.	APP.	CCN
	CCN 13131A	BLUE BIRD CORPORATION FORT VALLEY GEORGIA, U.S.A.			SCALE NONE
SCHEMATIC,WRG,BRAKE LIGHTS					
					M450
DR.	12/02/04	BY	SS	B	0075992
APP.	12/14/04	BY	BT		
INACTIVATES NOS.					PAGE - OF -

## Wiring Schematic 0102063 - Transmission

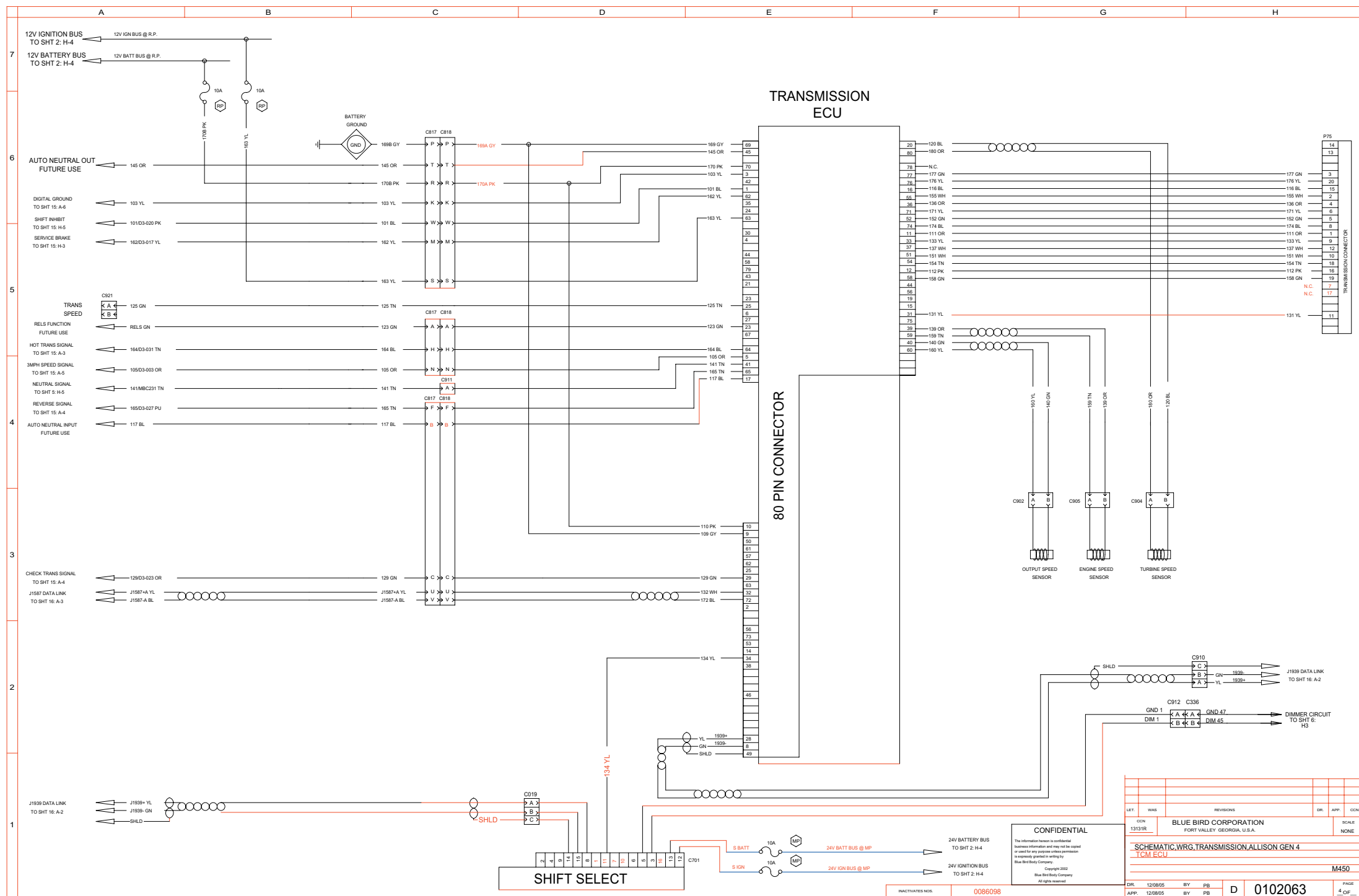



Wiring Schematic 0086078 - Engine Compartment Lights

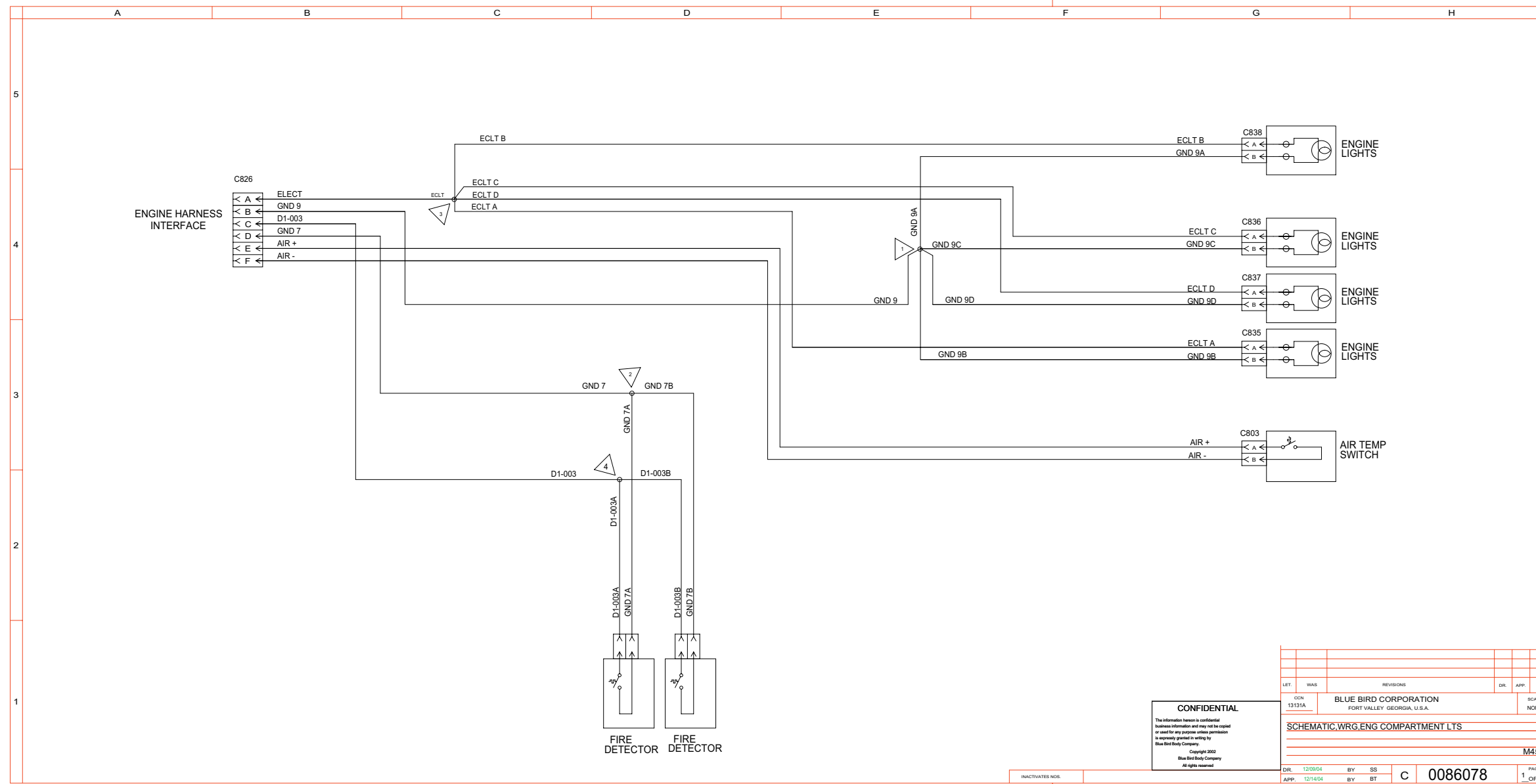

LET.	WAS	REVISIONS	DR.	APP.	CCN
CCN	13131A	BLUE BIRD CORPORATION FORT VALLEY, GEORGIA, U.S.A.			SCALE NONE
SCHEMATIC.WRG.ENG COMPARTMENT LTS					
M450					
DR.	12/28/04	BY	SS	C	0086078
APP.	12/14/04	BY	BT		
					PAGE 1 OF 1

## Wiring Schematic 0086777 - Webasto, Hydronic Control System

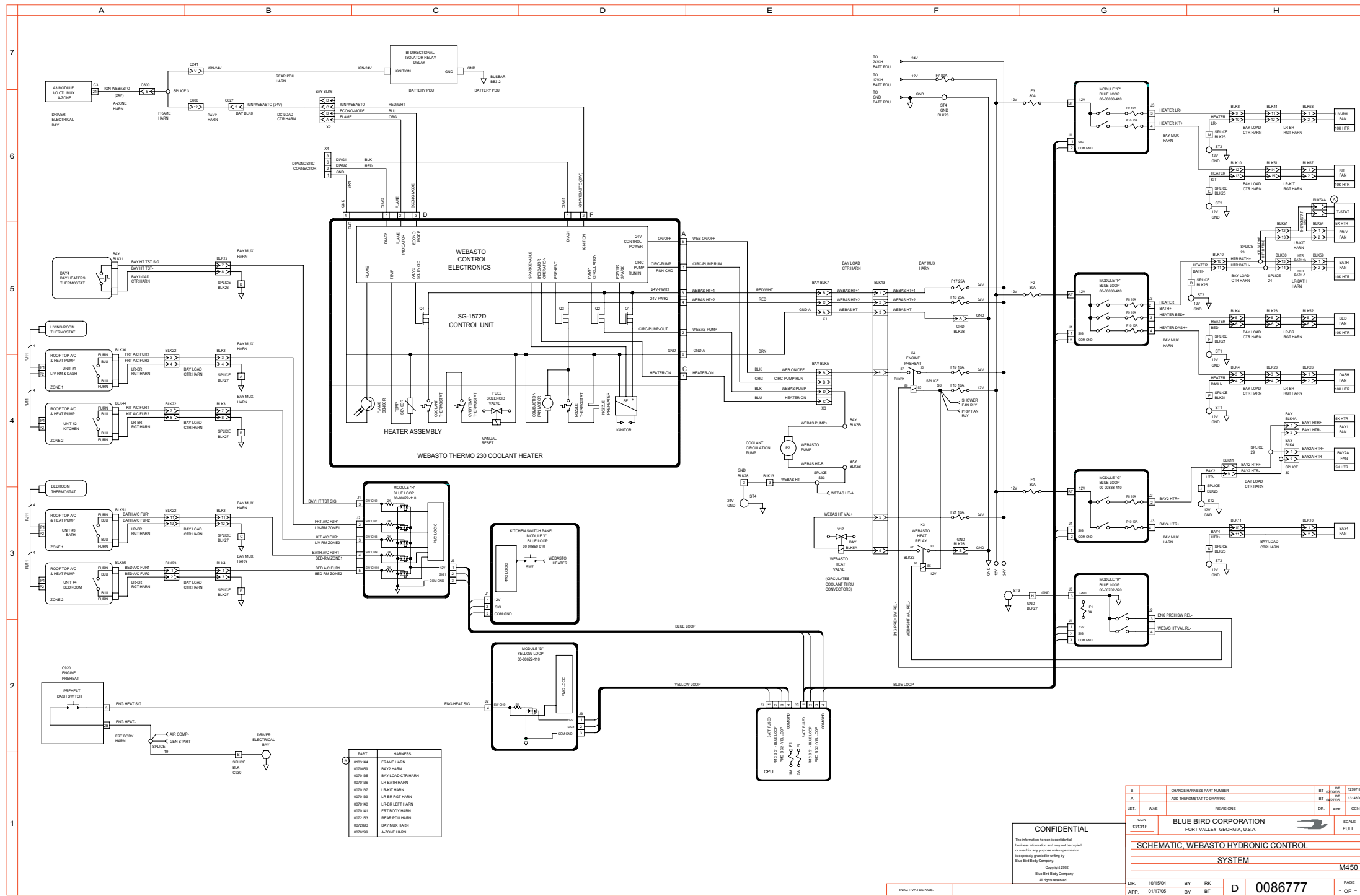



Wiring Schematic 0086777 - Webasto, Hydronic Control System - **Exploded View B**

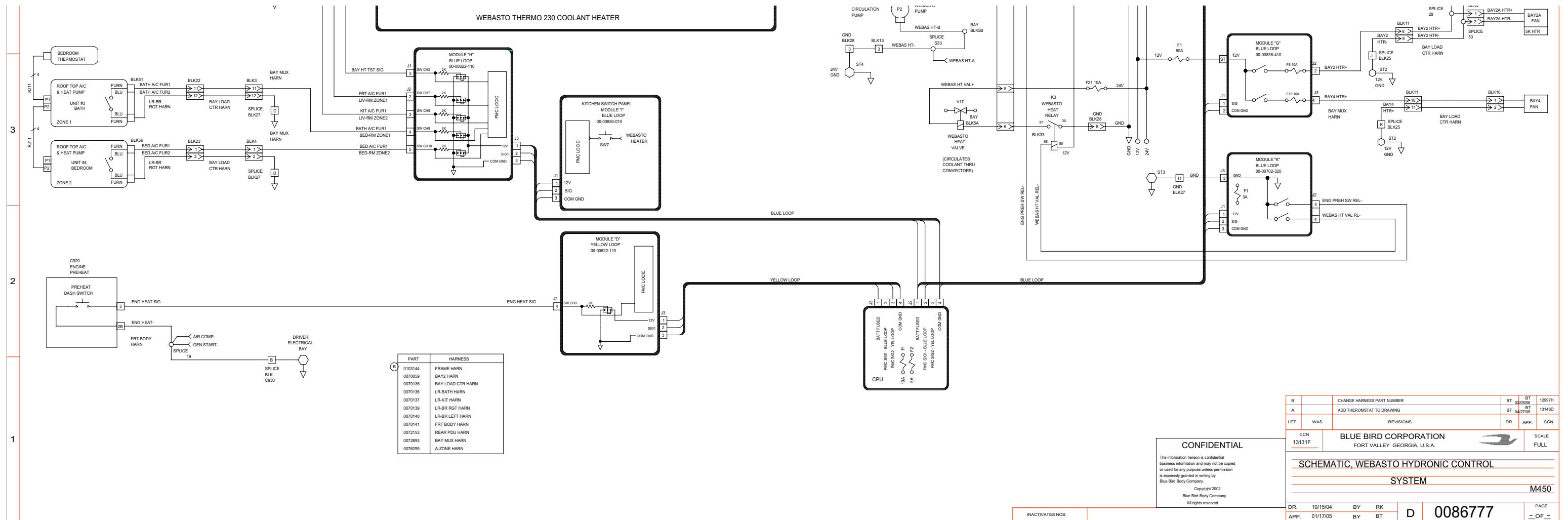

Wiring Schematic 0086778 - Engine, Dash, Webasto Heating System - Page 1 of 2

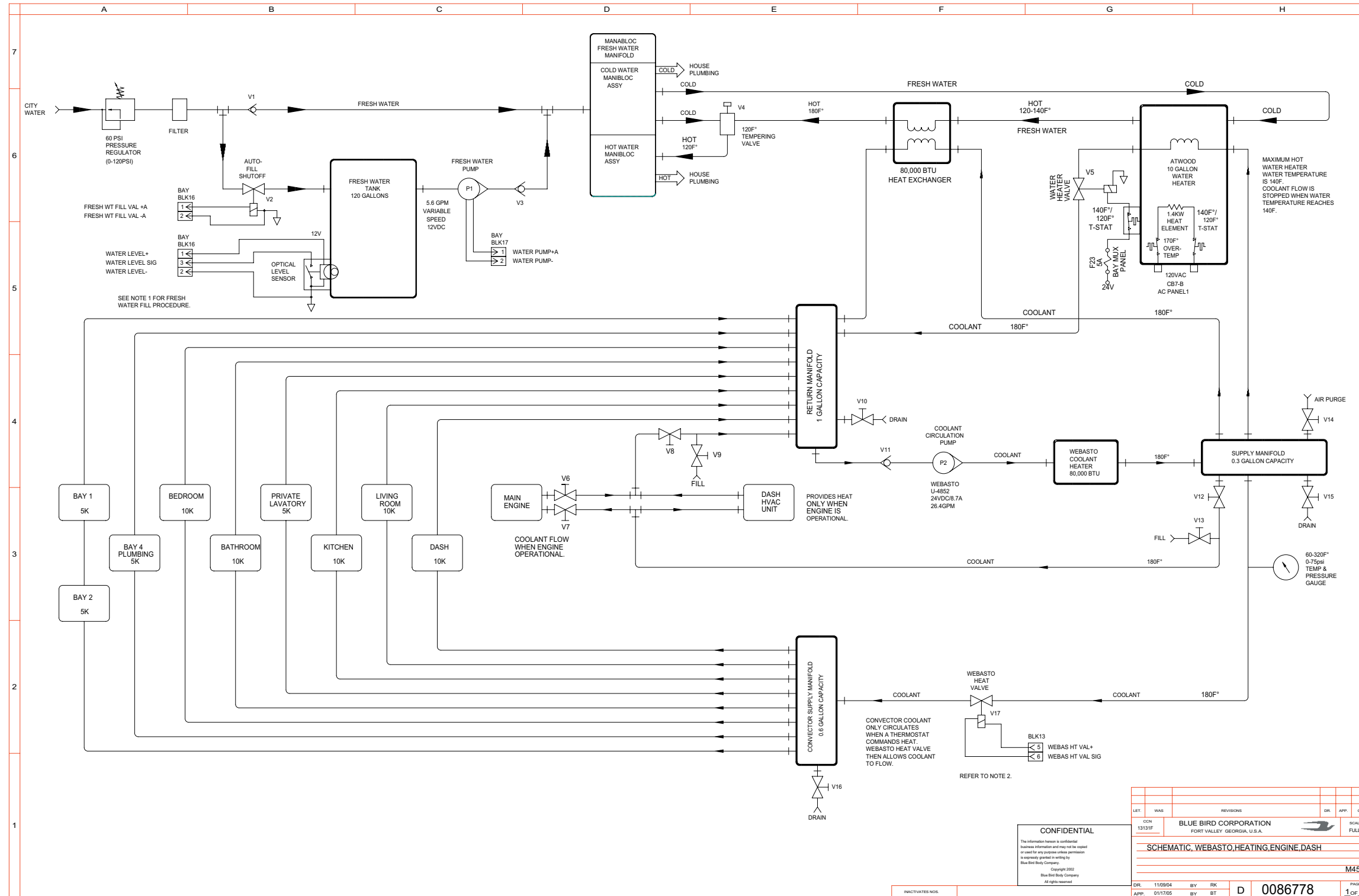

**CONFIDENTIAL**  
 The information herein is confidential business information and may not be copied or used for any purpose unless expressly in writing by Blue Bird Body Company.  
 Copyright 2002  
 Blue Bird Body Company  
 All rights reserved.

LET.	WAS	REVISIONS	DR.	APP.	CCN
CCN	13131F	BLUE BIRD CORPORATION FORT VALLEY, GEORGIA, U.S.A.			SCALE FULL
SCHEMATIC, WEBASTO, HEATING, ENGINE, DASH					M450
DR.	11/09/04	BY RK			PAGE
APP.	01/17/05	BY BT	D	0086778	1 of 2

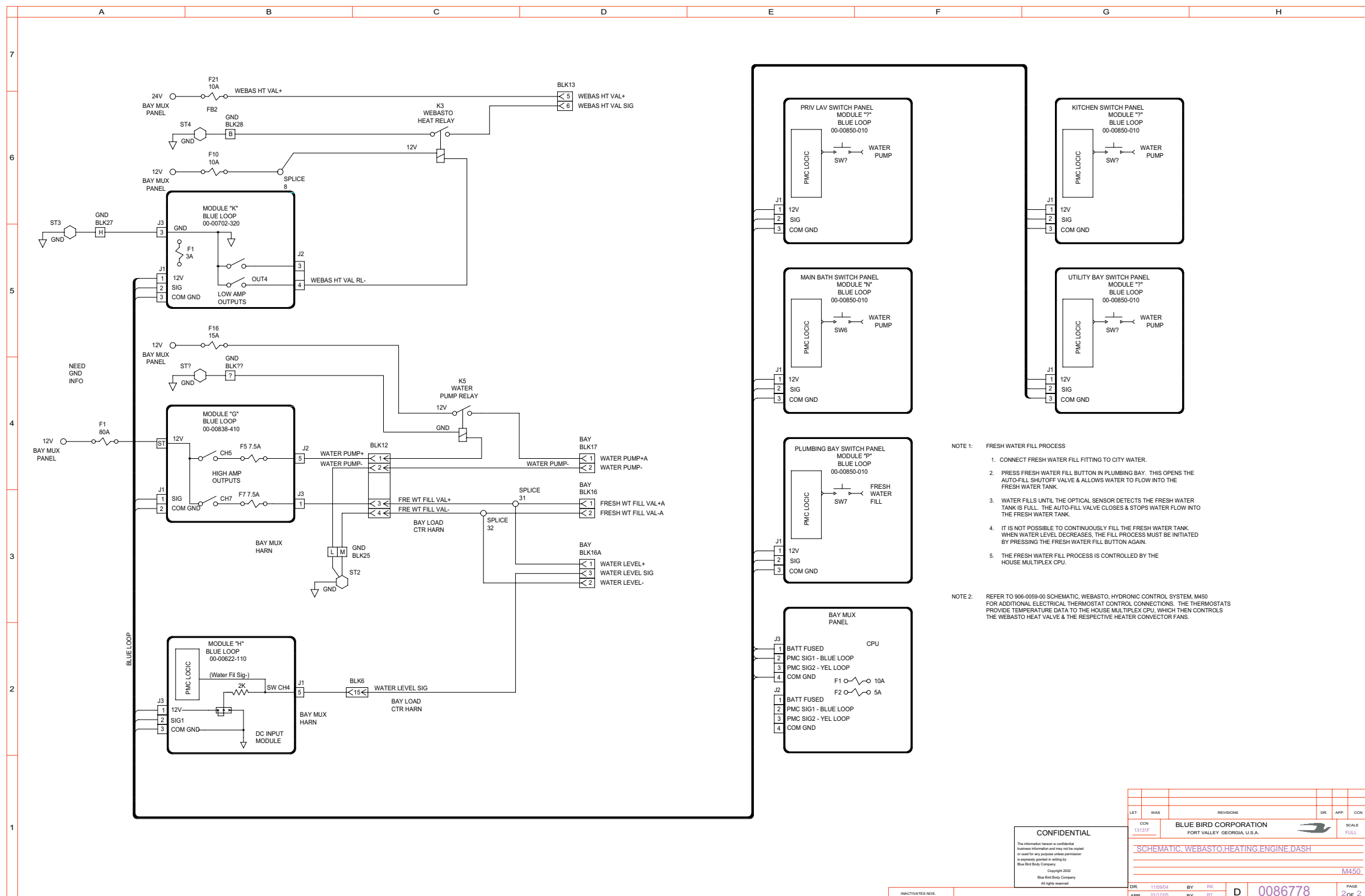



Wiring Schematic 0086762 - Living Room, Kitchen, Slide-Out, Bath, Floorplan A - Exploded View A

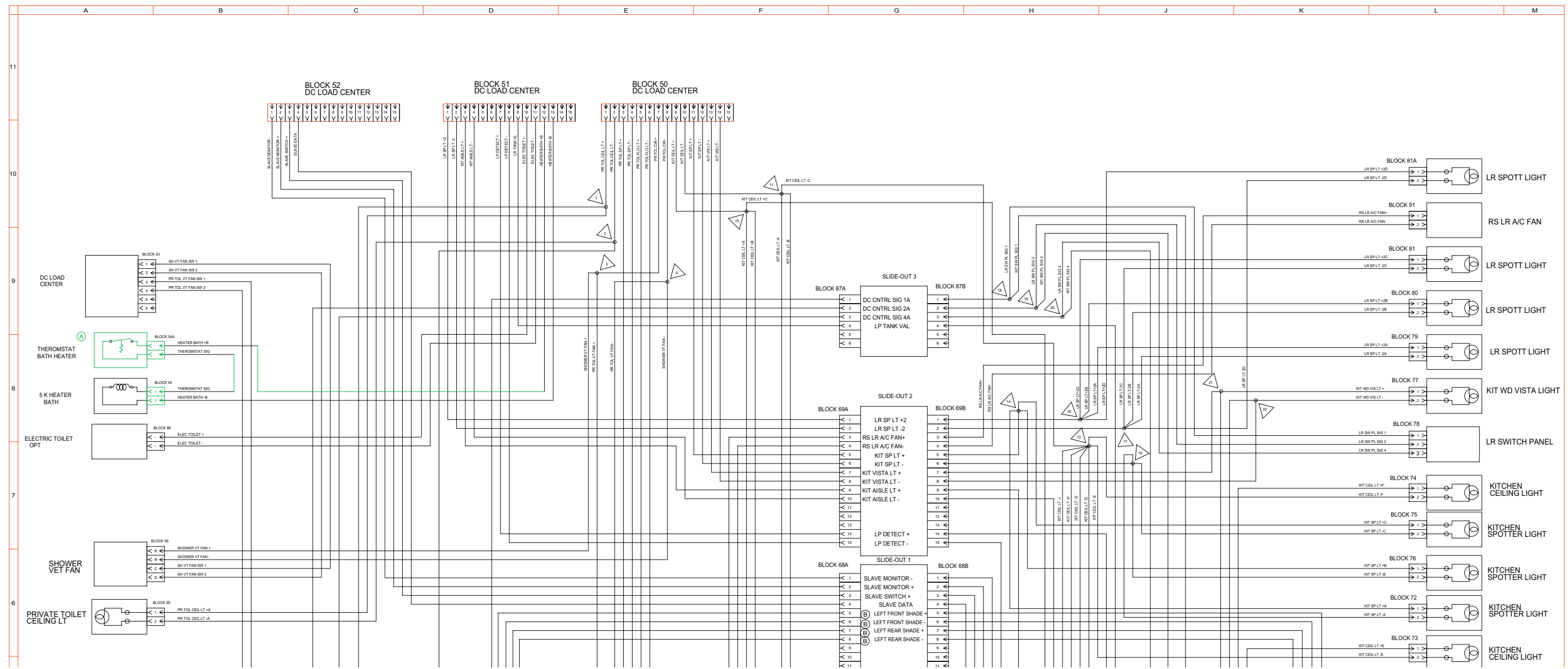



Wiring Schematic 0086762 - Living Room, Kitchen, Slide-Out, Bath, Floorplan A - Exploded View B

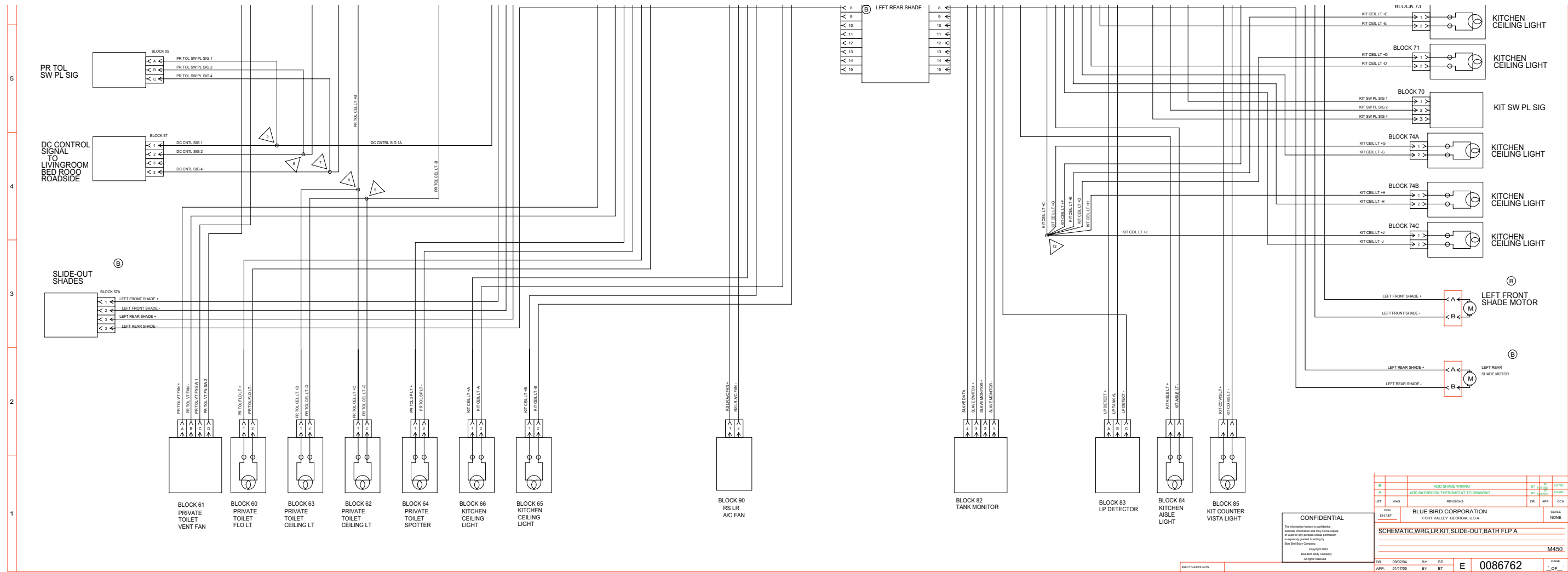

CONFIDENTIAL			
The information herein is confidential business information and may not be copied or used for any purpose other than that expressly granted in writing by Blue Bird Body Company. Copyright 2003 Blue Bird Body Company. All rights reserved.			
REV	DATE	BY	CHKD
B			
A			
13131F		BLUE BIRD CORPORATION FORT VALLEY, GEORGIA, U.S.A.	
SCHEMATIC.WRG LR KIT SLIDE-OUT BATH FLP A			
			M450
DR	09/20/04	BY	SS
APP	01/17/05	BY	BT
E 0086762			PAGE OF

Wiring Schematic 0086763 - Living Room, Kitchen, Slide-Out, Bath, Floorplan B

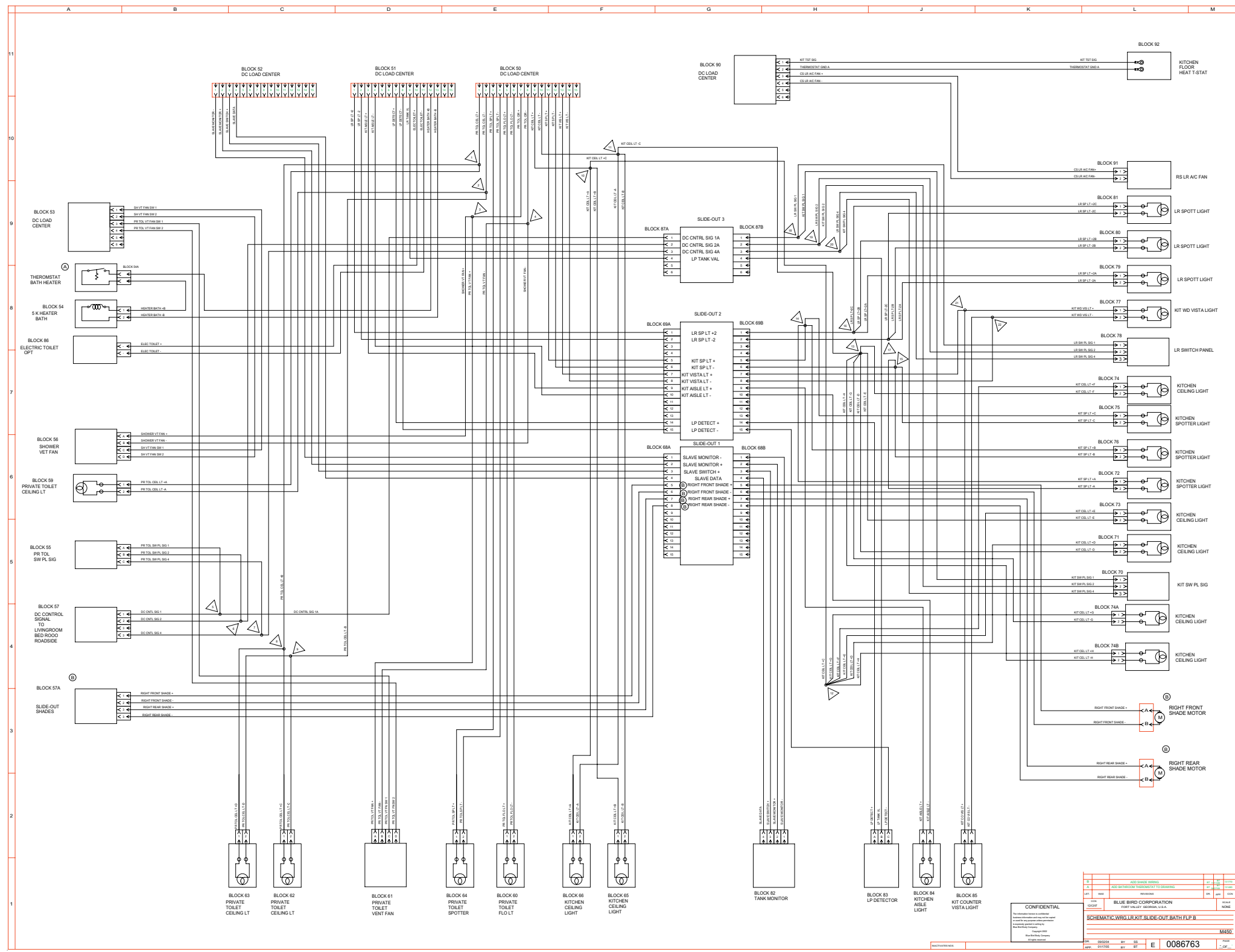

Wiring Schematic 0086763 - Living Room, Kitchen, Slide-Out, Bath, Floorplan B - Exploded View A

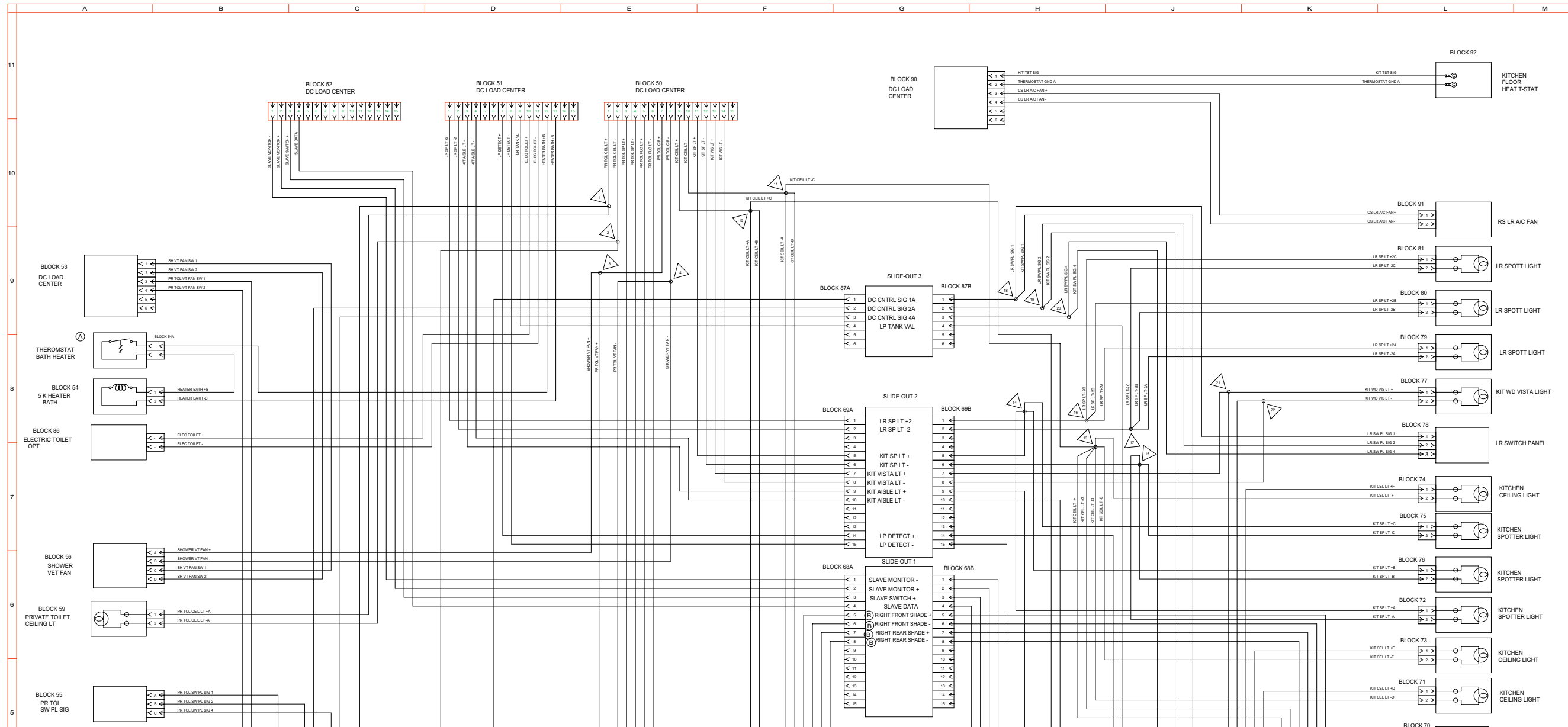

Wiring Schematic 0086763 - Living Room, Kitchen, Slide-Out, Bath, Floorplan B - Exploded View B

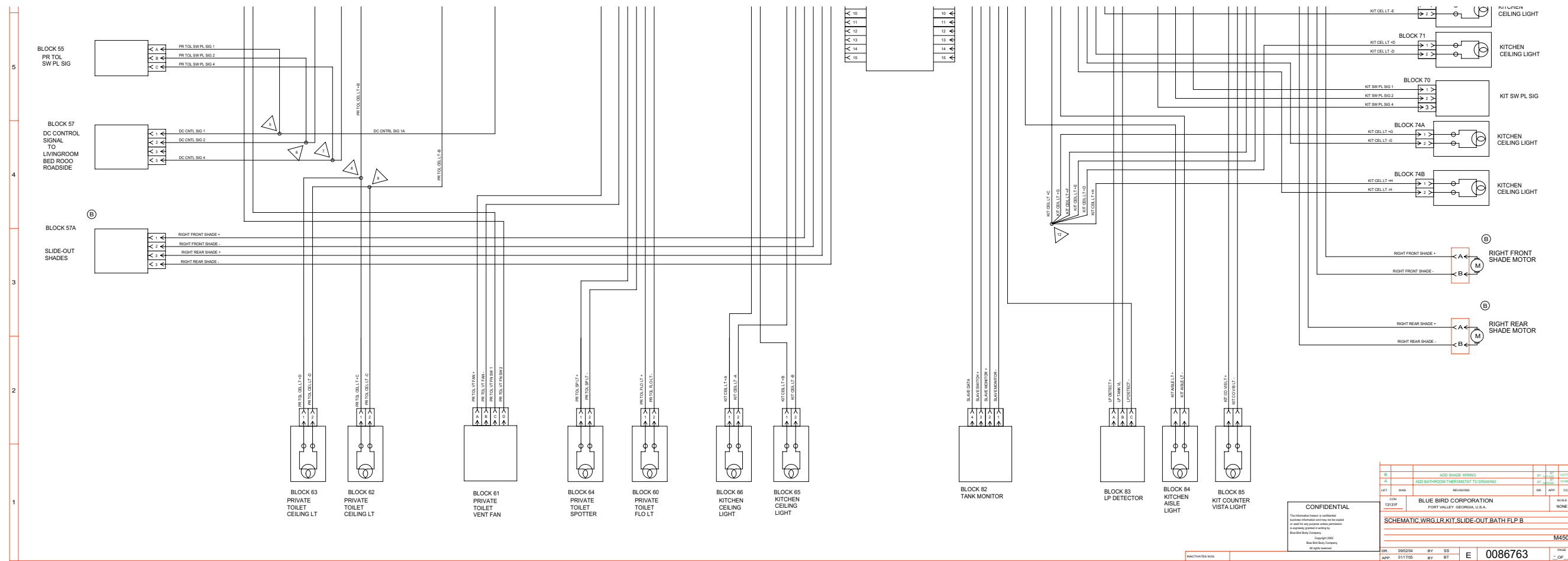

Wiring Schematic 0095819 - 120Vac, Power Distribution/EMS, Floorplan B - Page 1 of 2

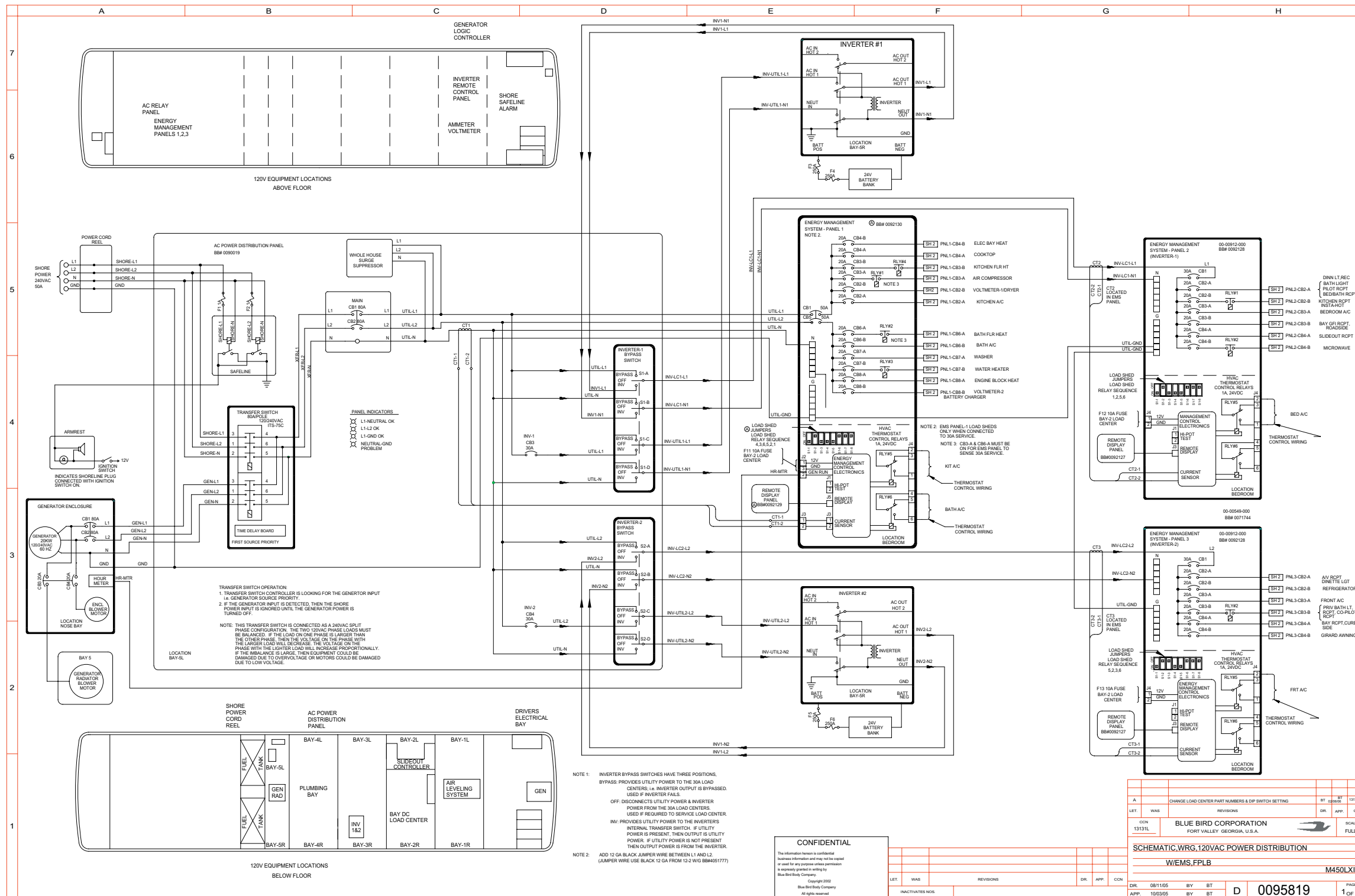

LET.	WAS	REVISIONS	DR.	APP.	CCN
A	CHANGE LOAD CENTER PART NUMBERS & DIP SWITCH SETTING	BT	08/05	13/77	
LET.	WAS	REVISIONS	DR.	APP.	CCN
CCN	13131L	BLUE BIRD CORPORATION			SCALE FULL
FORT VALLEY GEORGIA, U.S.A.					
SCHEMATIC.WRG.120VAC POWER DISTRIBUTION					
W/EMS,FPLB					
M450LXI					
DR.	08/11/05	BY	BT		PAGE
APP.	10/03/05	BY	BT	D	0095819
					1 of 2

Wiring Schematic 0095819 - 120Vac, Power Distribution/EMS, Floorplan B - Page 2 of 2

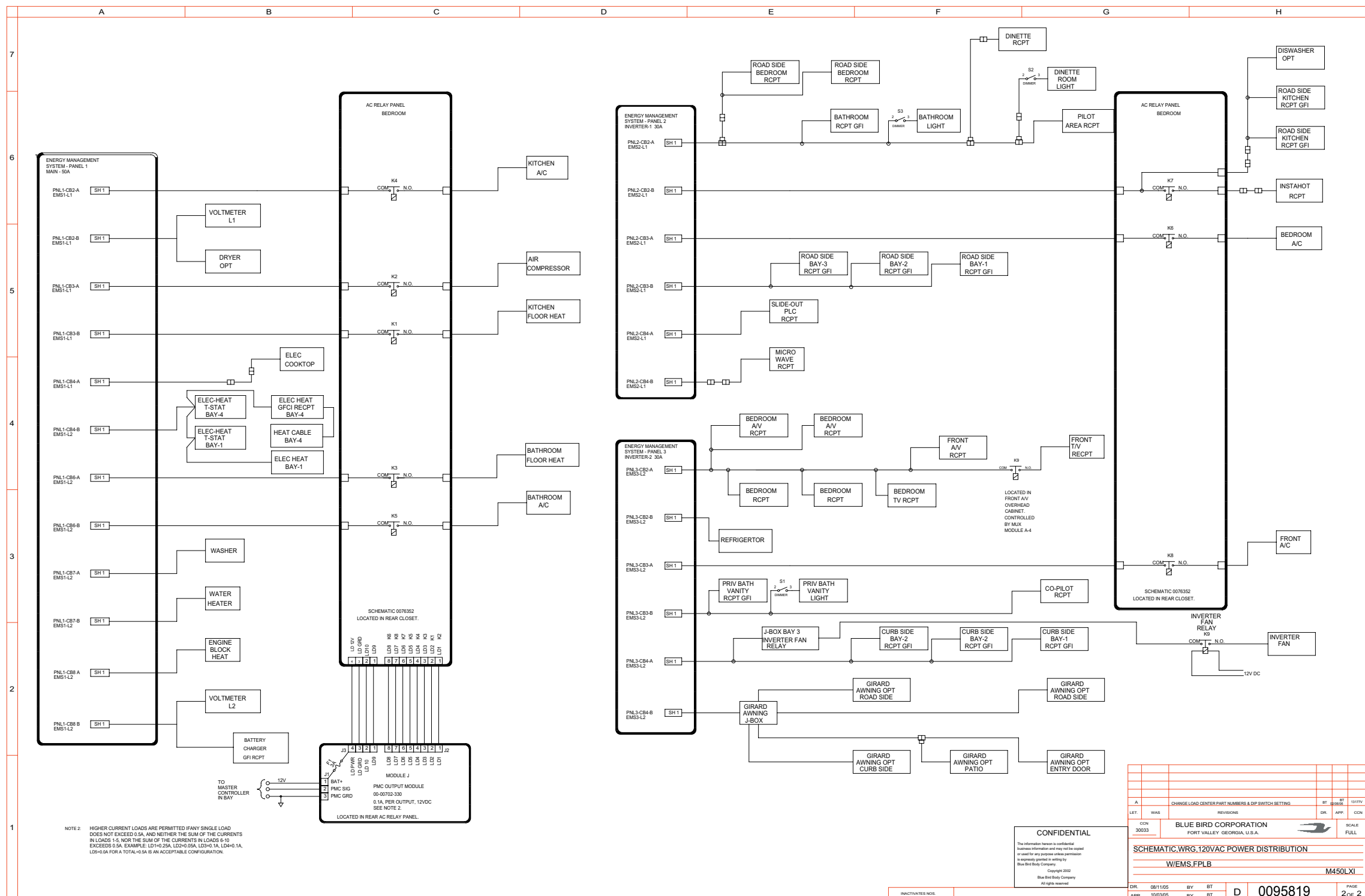

Wiring Schematic 0095819 - 120Vac, Power Distribution/EMS, Floorplan B - Page 2 of 2 - Exploded View A

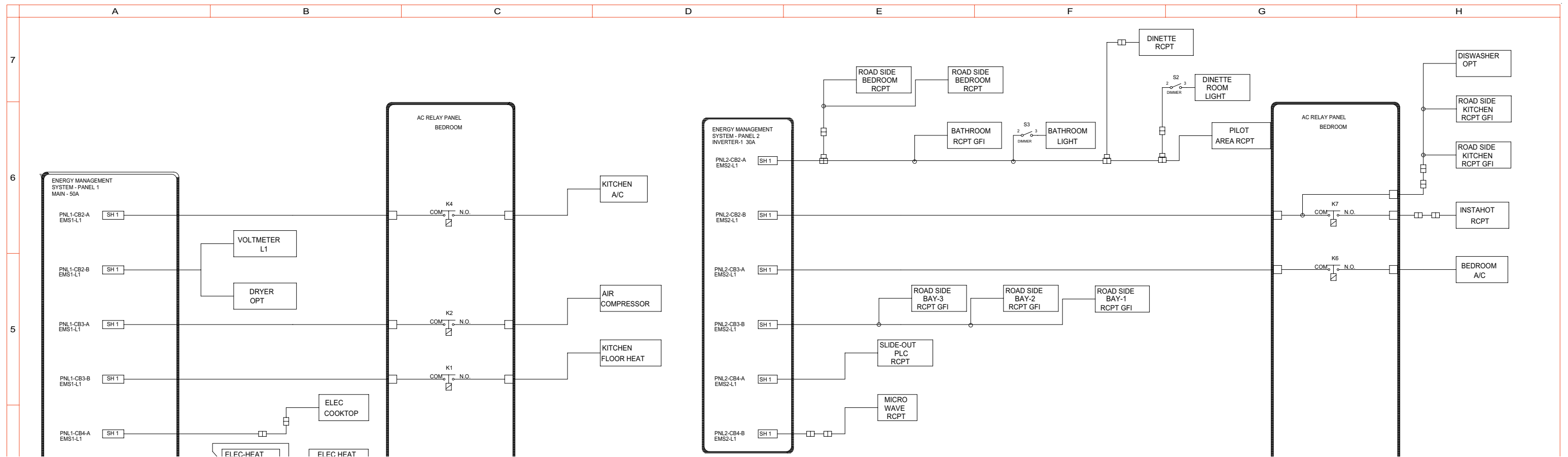

Wiring Schematic 0095819 - 120Vac, Power Distribution/EMS, Floorplan B - Page 2 of 2 - **Exploded View B**

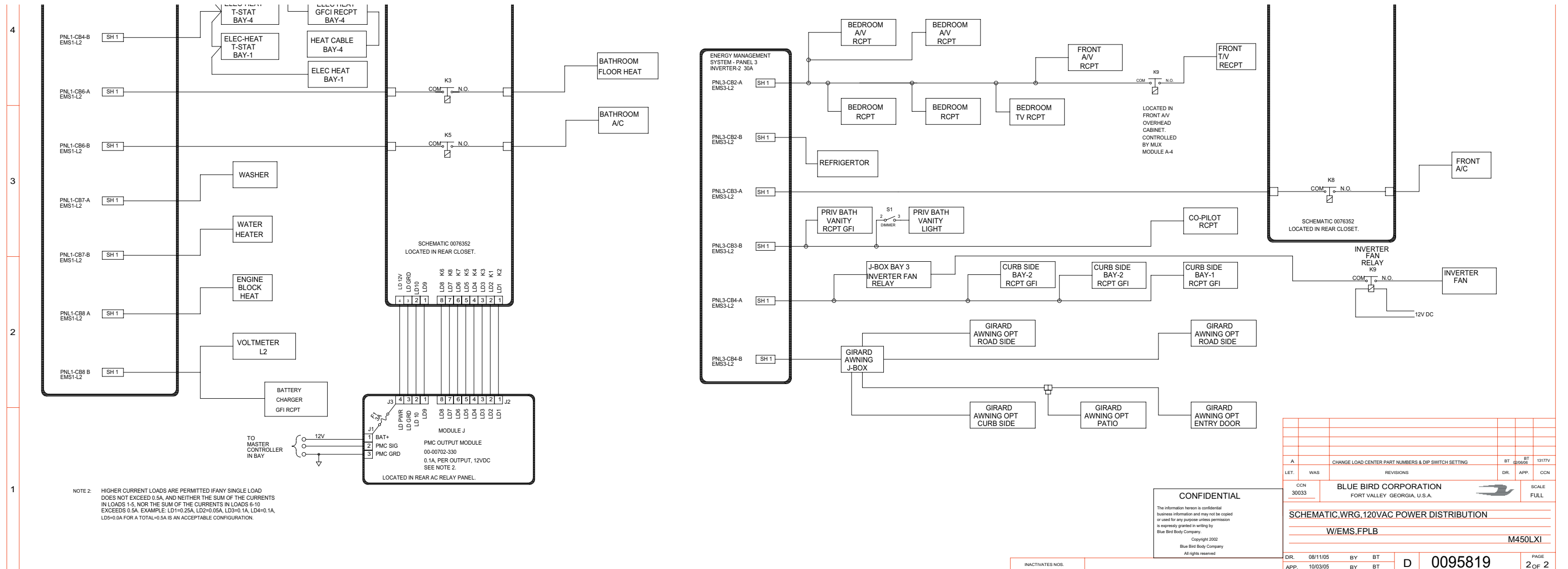



Wiring Schematic 0089285 - Schematic, Wiring, Landing Lights

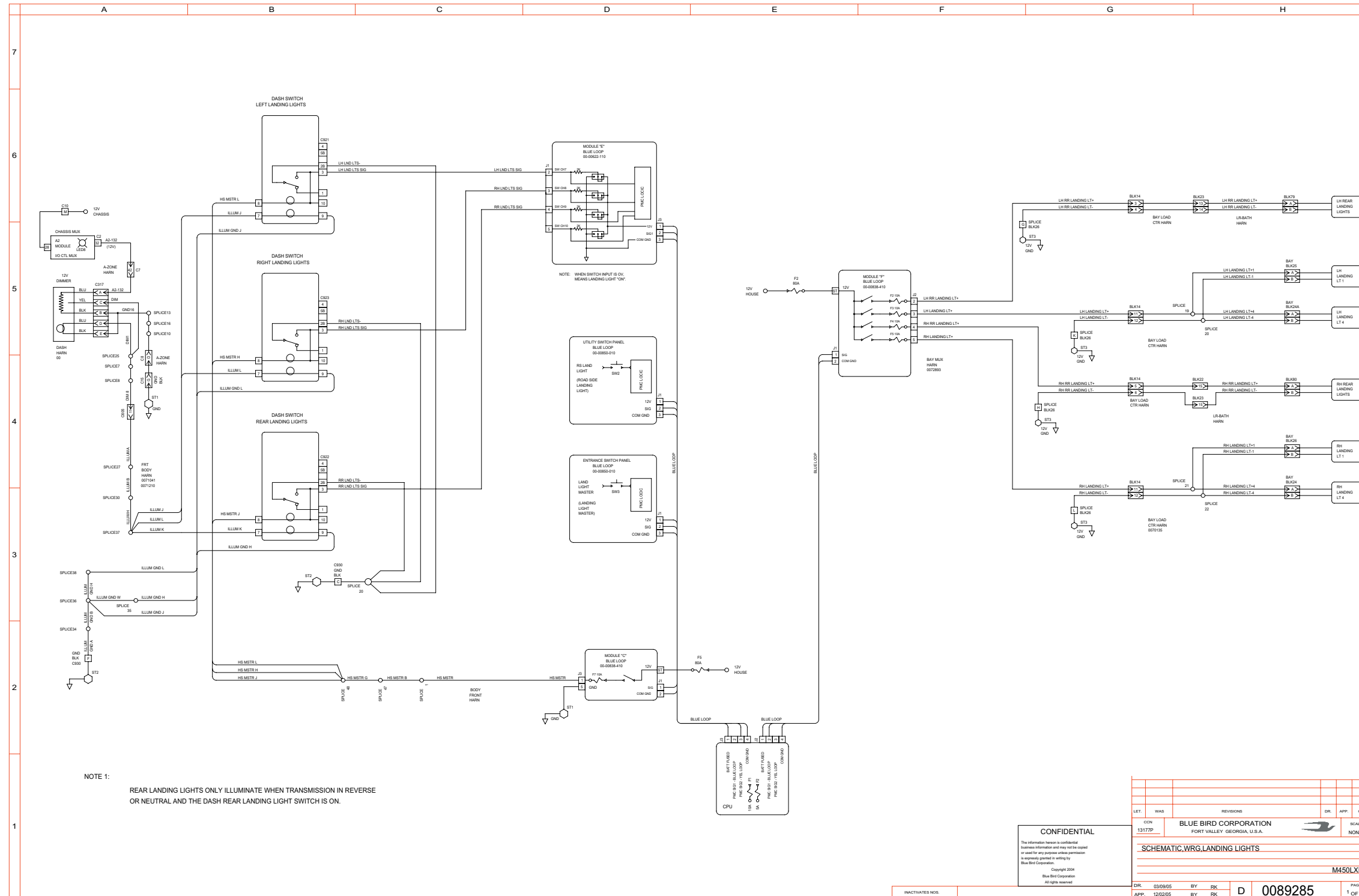



Wiring Schematic 0089321 - Schematic, Wiring, Generator Sys, 120/240Vac - Page 1 of 3 - Exploded View A

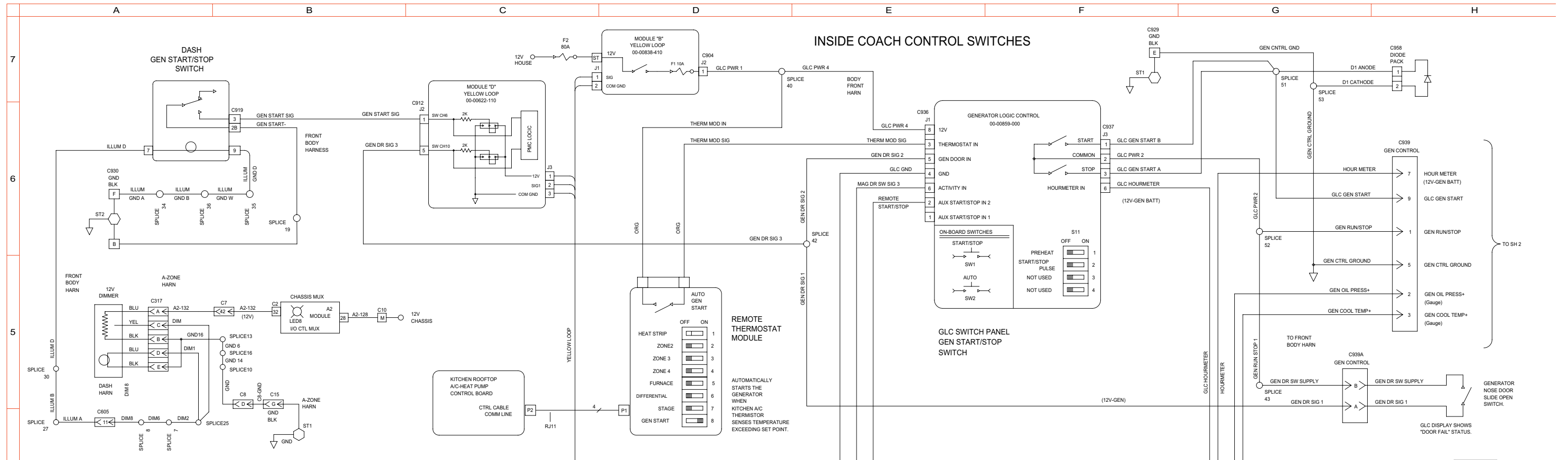

Wiring Schematic 0089321 - Schematic, Wiring, Generator Sys, 120/240Vac - Page 1 of 3 - Exploded View B

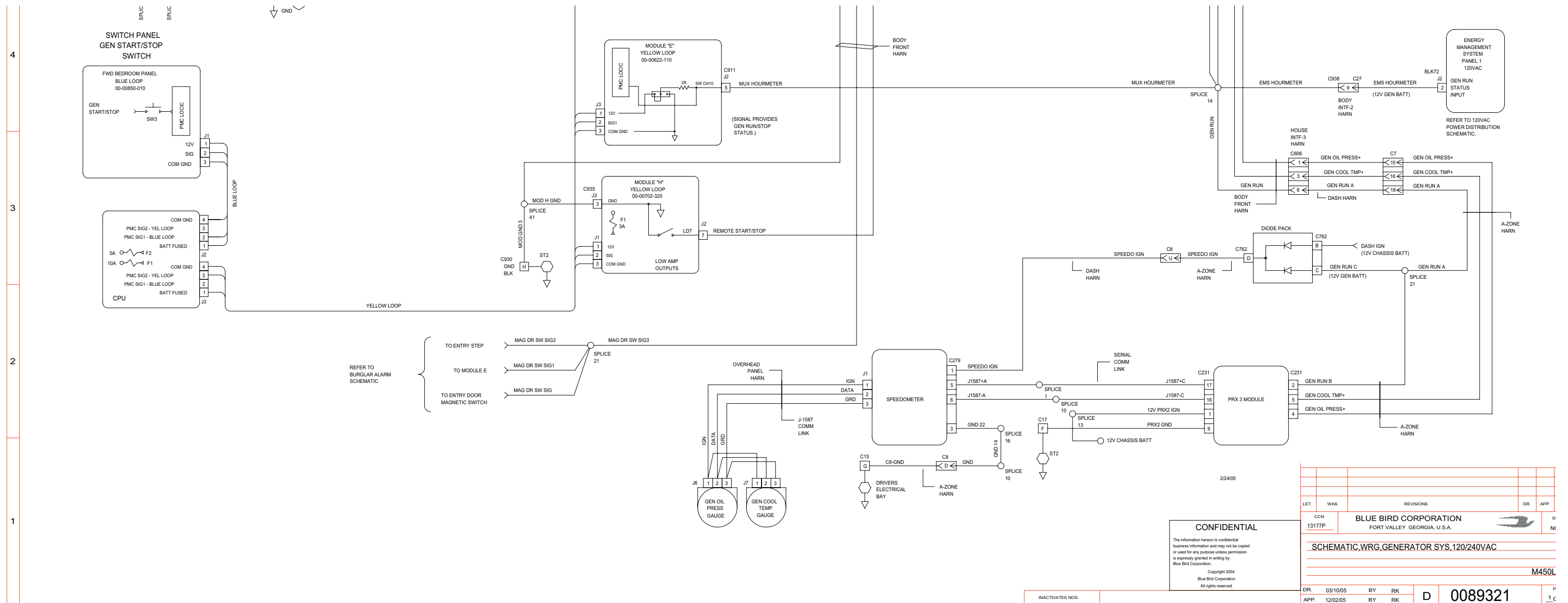

**CONFIDENTIAL**  
 The information herein is confidential business information and may not be copied or used for any purpose unless permission is expressly granted in writing by Blue Bird Corporation.  
 Copyright 2004  
 Blue Bird Corporation  
 All rights reserved.

LET.	WAS	REVISIONS	DR.	APP.
CCN 13177P	BLUE BIRD CORPORATION FORT VALLEY GEORGIA, U.S.A.			
SCHEMATIC.WRG.GENERATOR SYS.120/240VAC				
M450L				
DR.	03/10/05	BY	RK	
APP.	12/02/05	BY	RK	
				D 0089321
				1 c

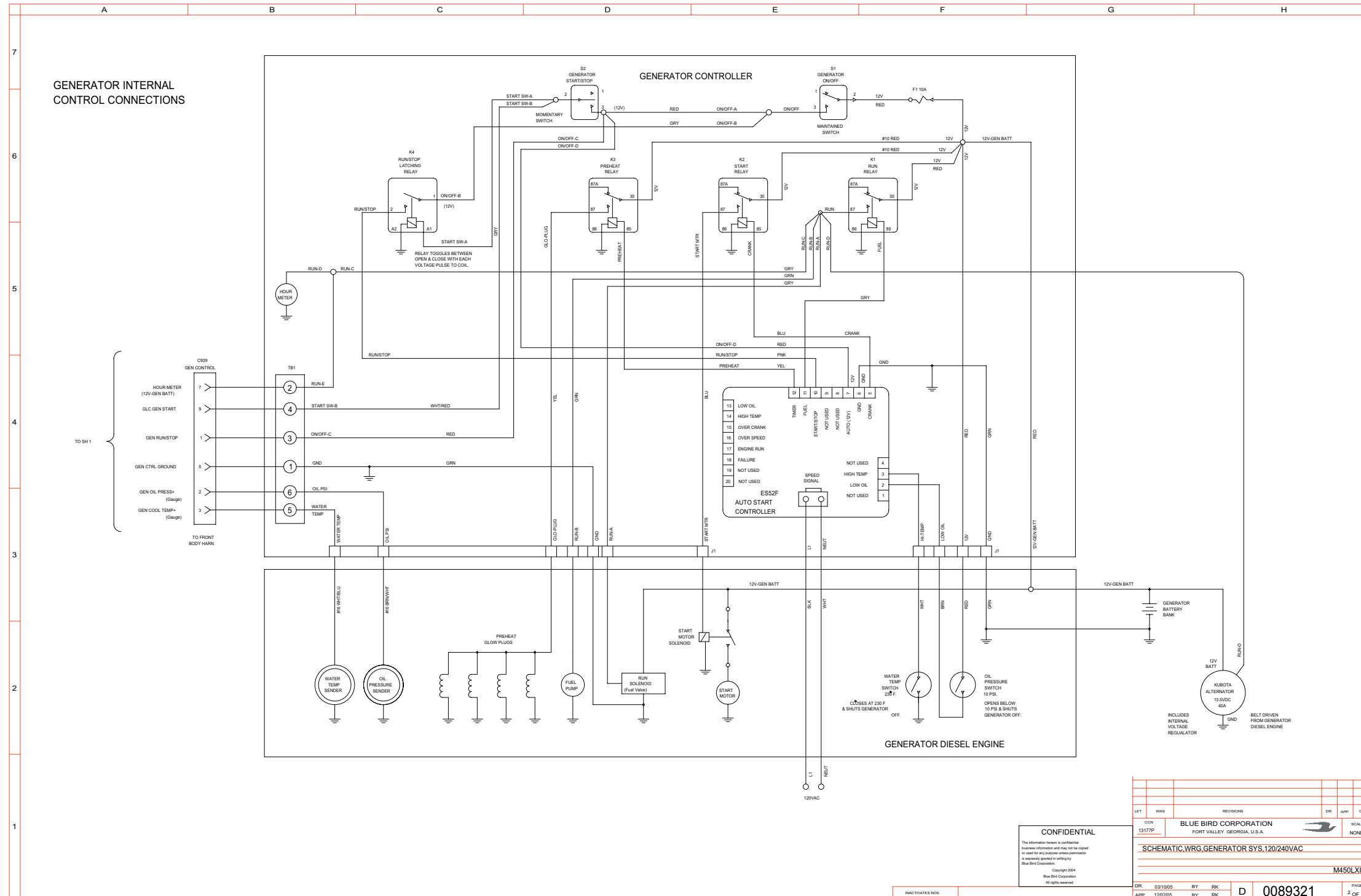

Wiring Schematic 0089321 - Schematic, Wiring, Generator Sys, 120/240Vac - Page 2 of 3 - **Exploded View A**

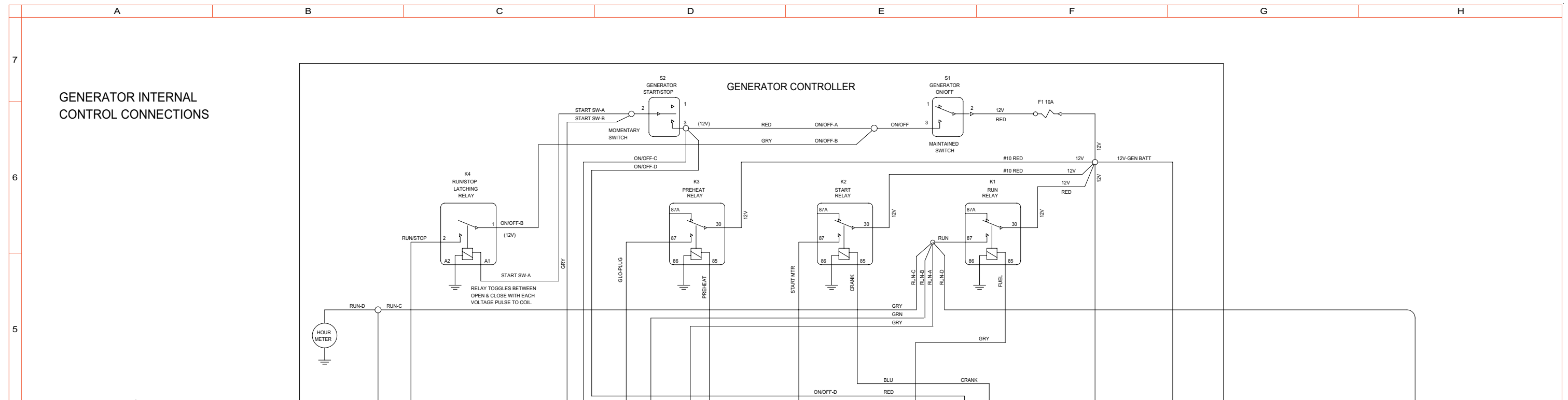

Wiring Schematic 0089321 - Schematic, Wiring, Generator Sys, 120/240Vac - Page 2 of 3 - Exploded View B

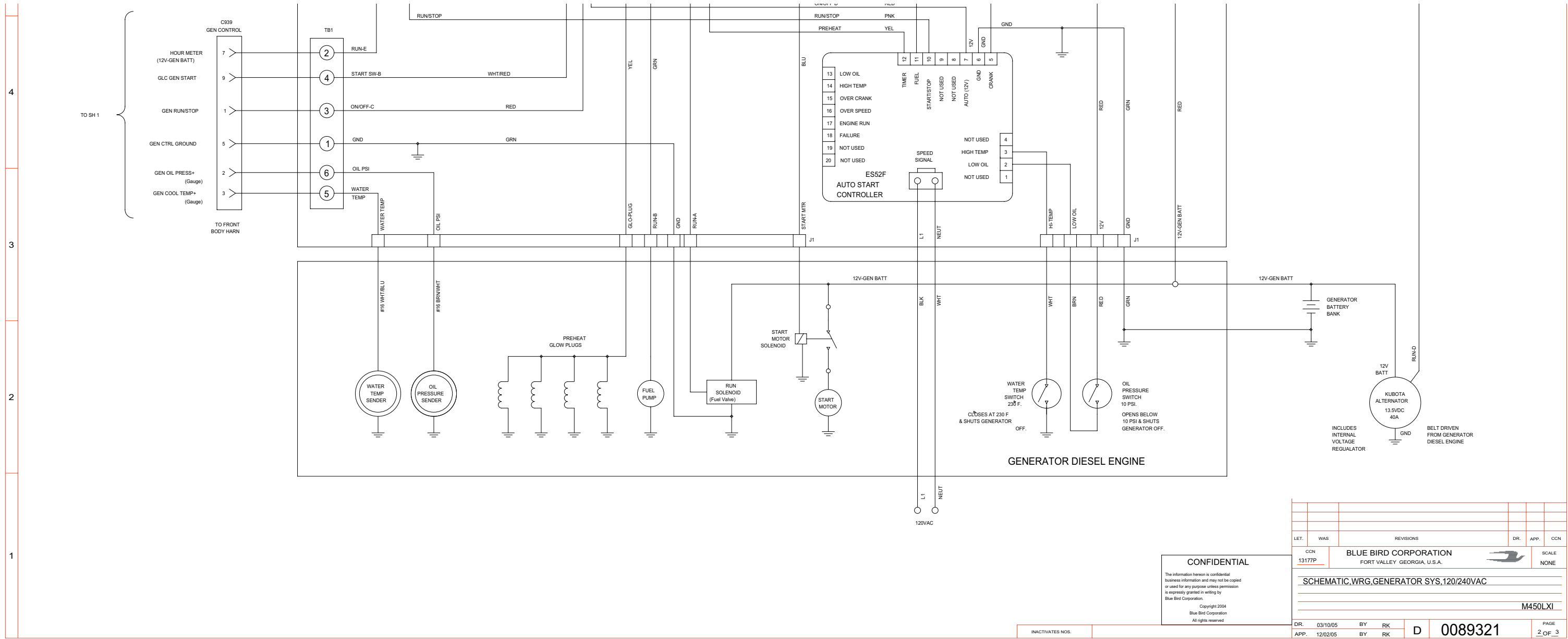

**CONFIDENTIAL**  
 The information herein is confidential business information and may not be copied or used for any purpose unless permission is expressly granted in writing by Blue Bird Corporation.  
 Copyright 2004 Blue Bird Corporation  
 All rights reserved.

LET.	WAS	REVISIONS	DR.	APP.	CCN
CCN	13177P	BLUE BIRD CORPORATION FORT VALLEY, GEORGIA, U.S.A.			SCALE NONE
SCHEMATIC, WRG, GENERATOR SYS, 120/240VAC					
M450LXI					
DR.	03/10/05	BY	RK	D	0089321
APP.	12/02/05	BY	RK		

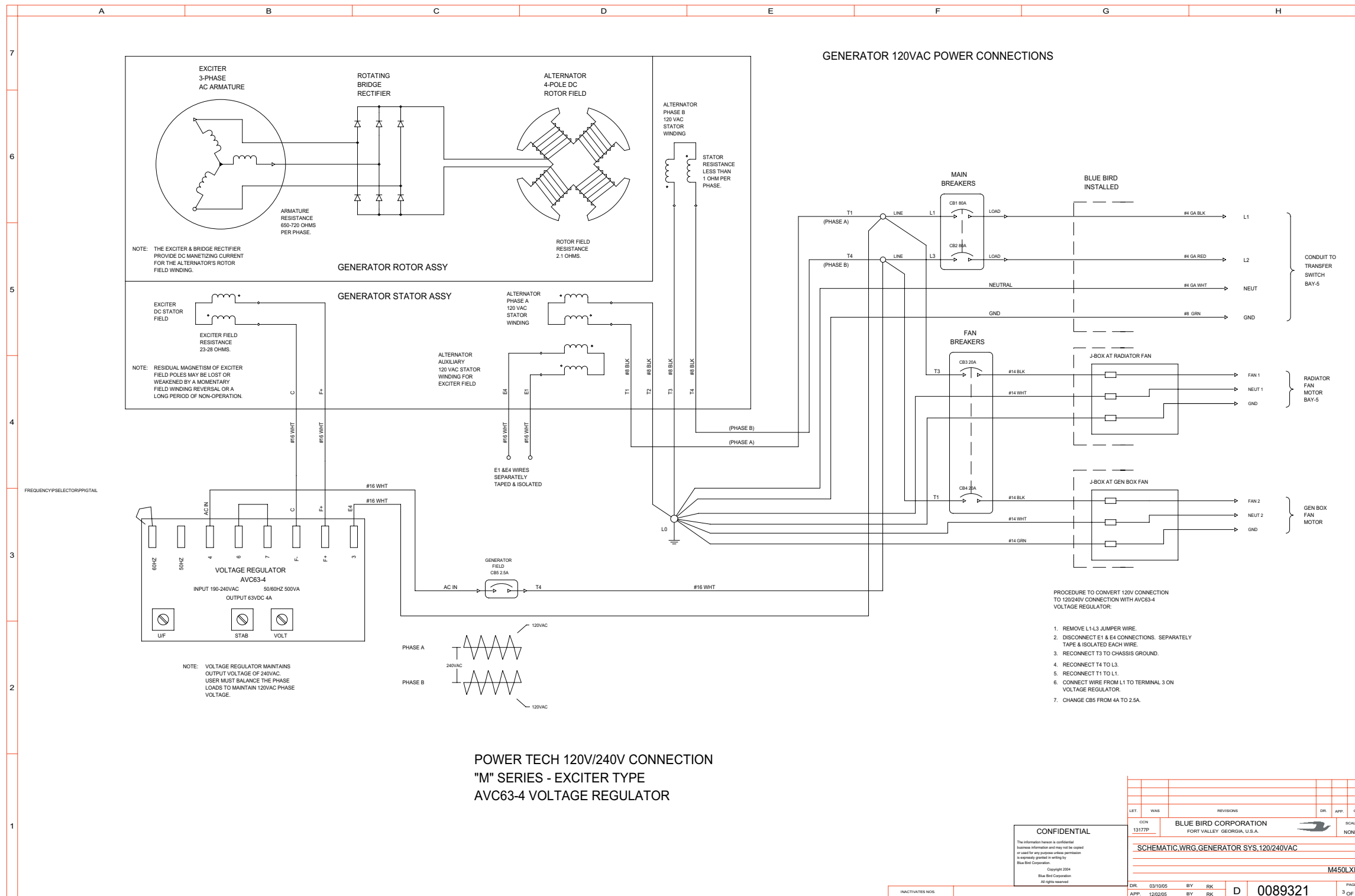



Wiring Schematic 0089321 - Schematic, Wiring, Generator Sys, 120/240Vac - Page 3 of 3 - Exploded View A

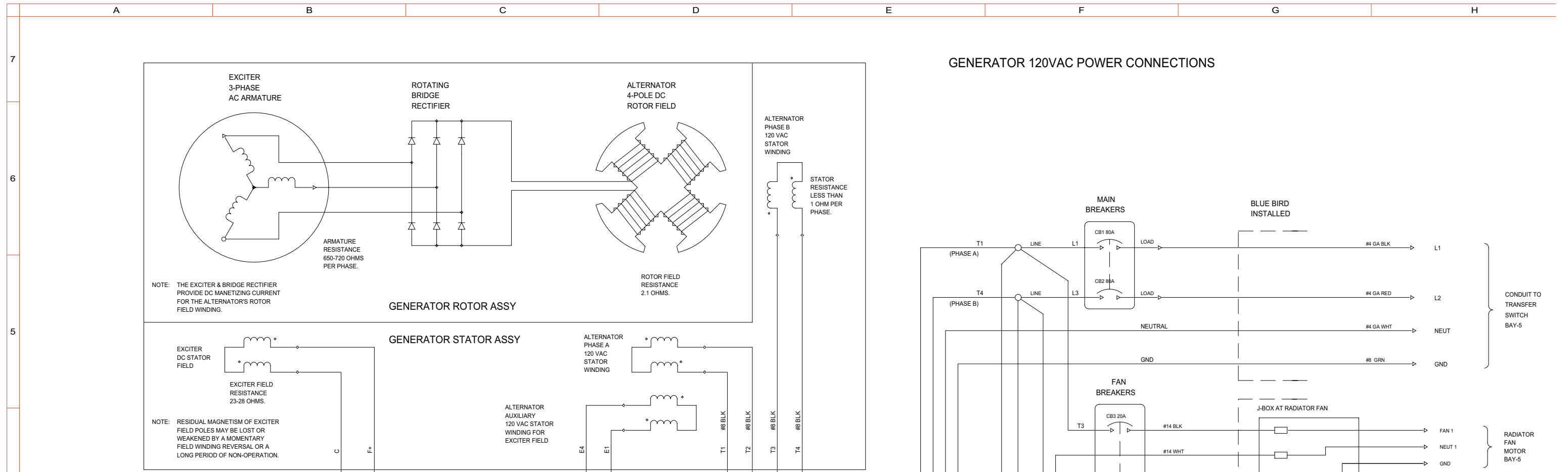

Wiring Schematic 0089321 - Schematic, Wiring, Generator Sys, 120/240Vac - Page 3 of 3 - Exploded View B

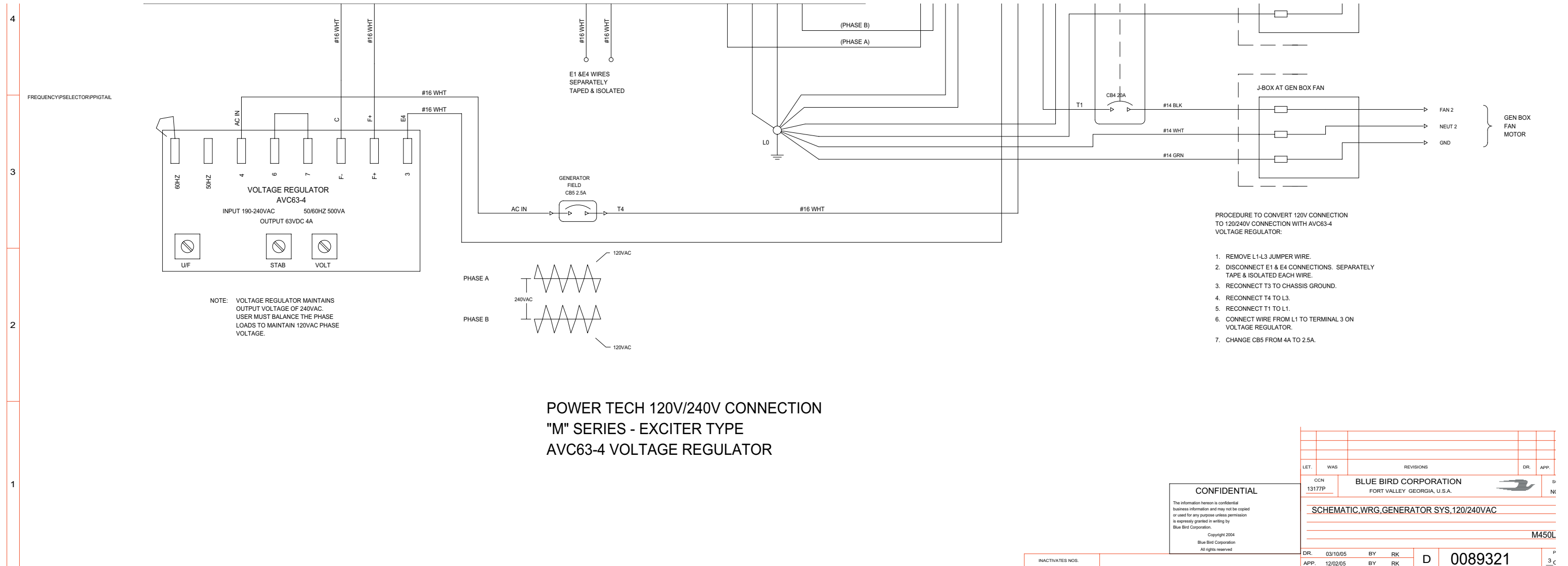

**CONFIDENTIAL**  
 The information herein is confidential business information and may not be copied or used for any purpose unless permission is expressly granted in writing by Blue Bird Corporation.  
 Copyright 2004  
 Blue Bird Corporation  
 All rights reserved

LET.	WAS	REVISIONS	DR.	APP.
CCN	BLUE BIRD CORPORATION			
13177P	FORT VALLEY GEORGIA, U.S.A.			
SCHEMATIC.WRG.GENERATOR SYS.120/240VAC				
M450L				
DR.	03/10/05	BY	RK	
APP.	12/02/05	BY	RK	
D				0089321
				3 c

Wiring Schematic 0089322 - Schematic, Wiring, Eng, Dash, Web, Heating, Sys - Page 1 of 2

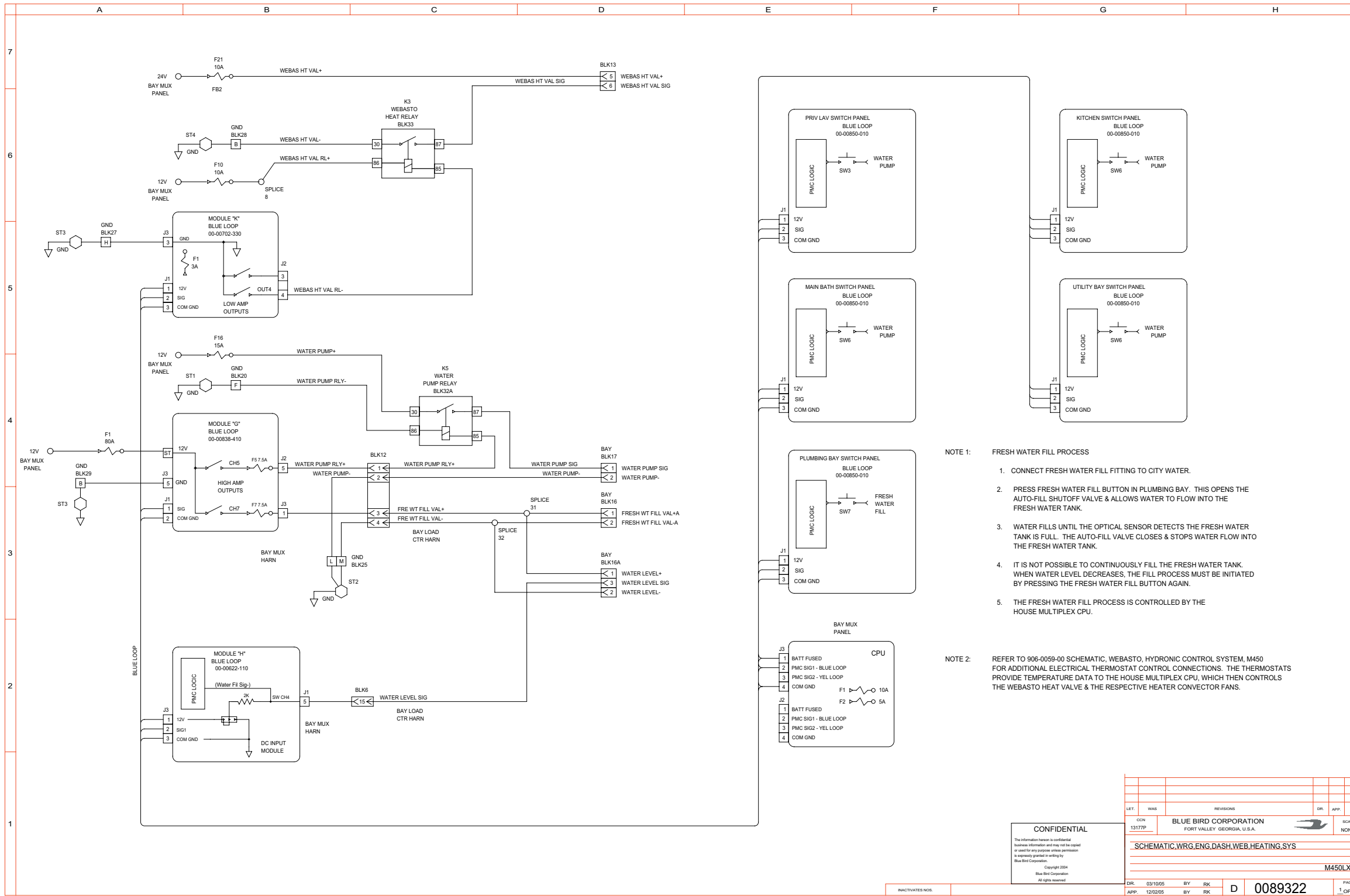

Wiring Schematic 0089322 - Schematic, Wiring, Eng, Dash, Web, Heating, Sys - Page 2 of 2

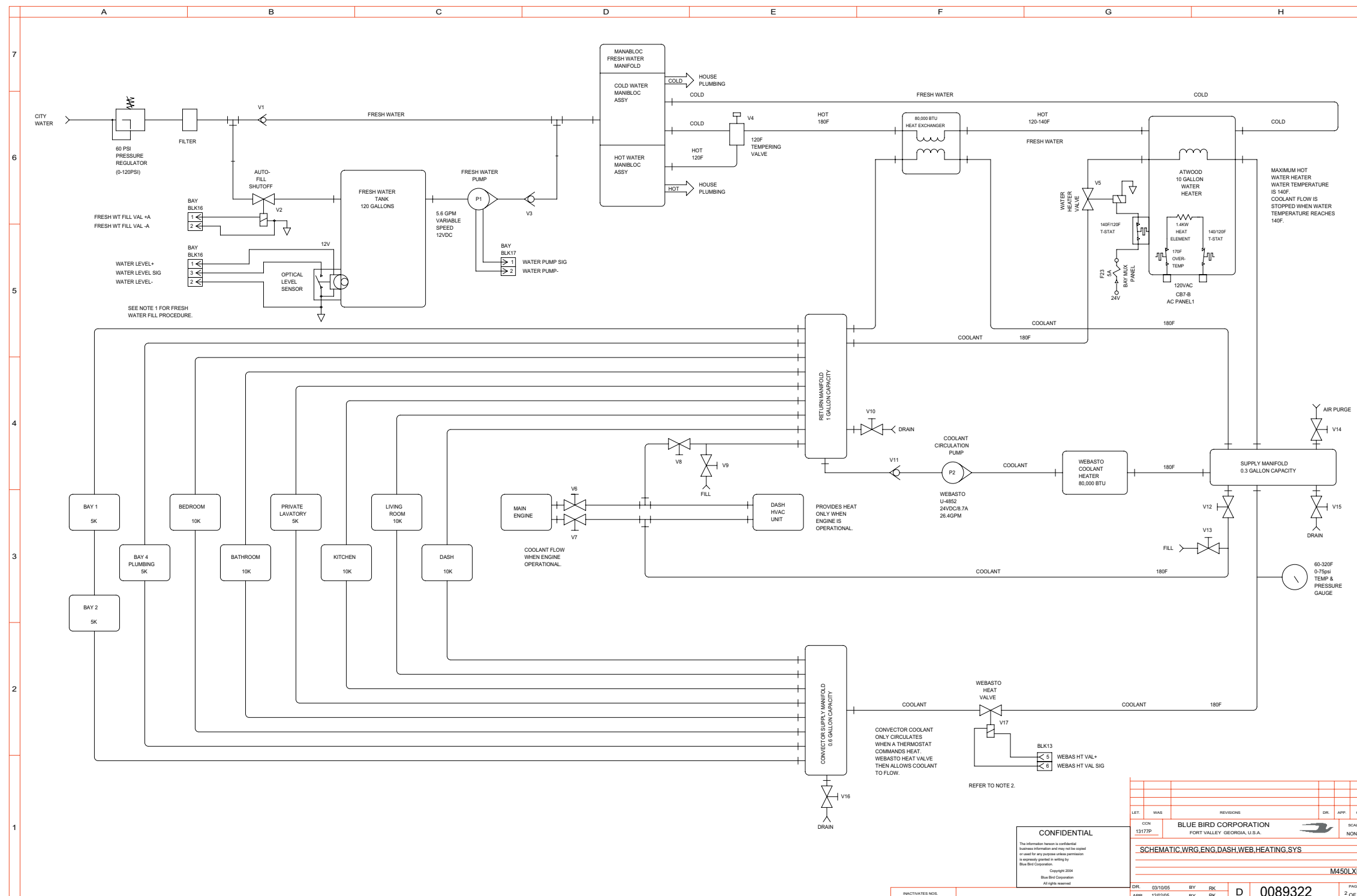

Wiring Schematic 0089536 - Schematic, Wiring, Dual Motors Synchronizer

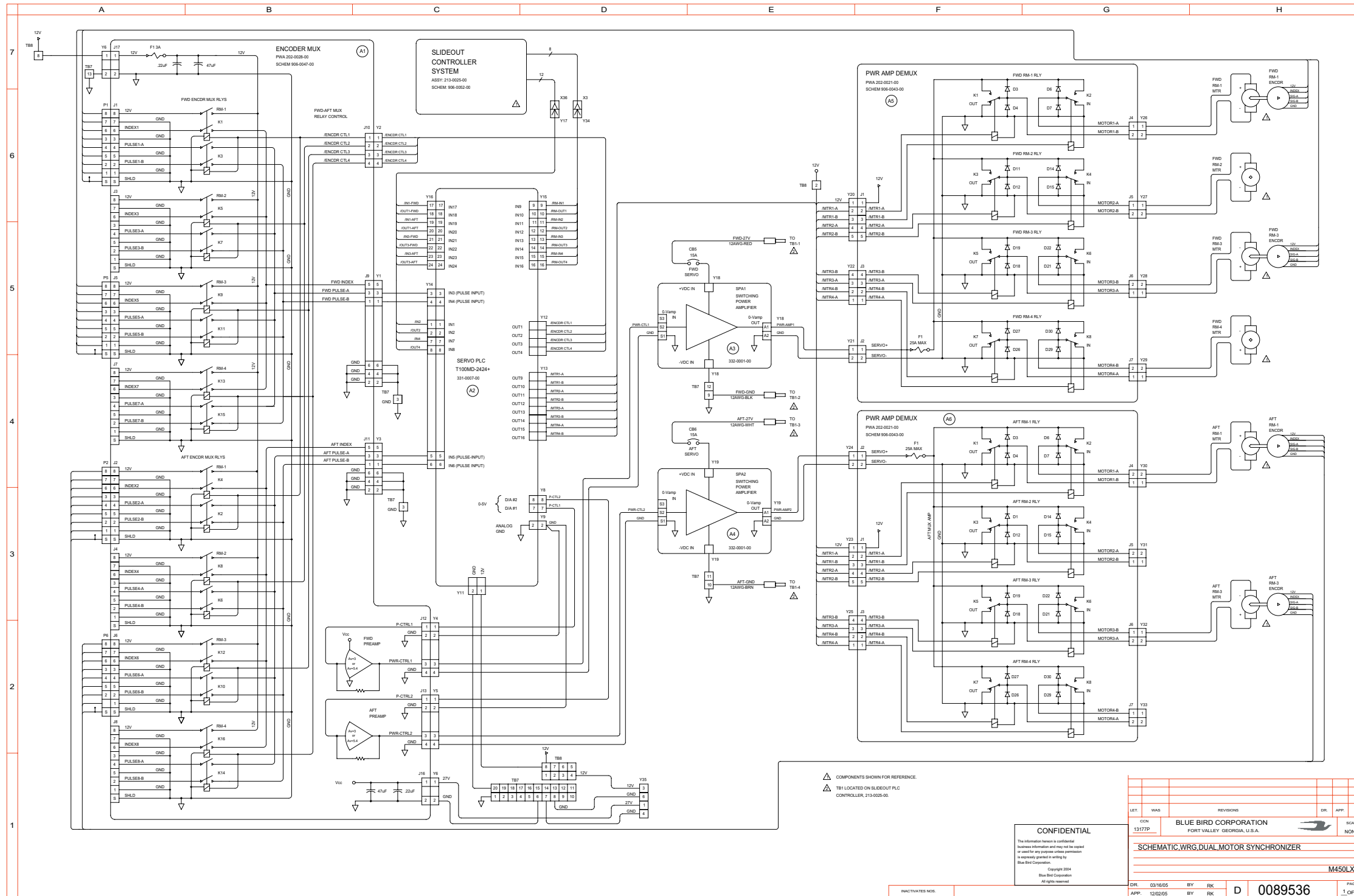

Wiring Schematic 0089536 - Schematic, Wiring, Dual Motors Synchronizer - Exploded View A

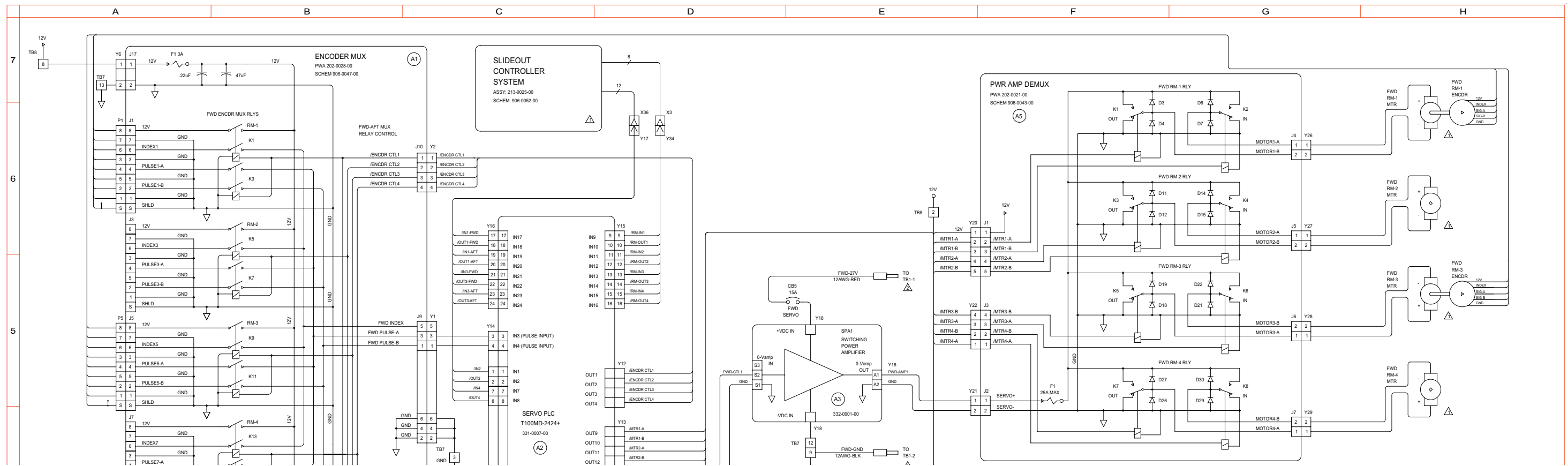

Wiring Schematic 0089536 - Schematic, Wiring, Dual Motors Synchronizer - Exploded View B

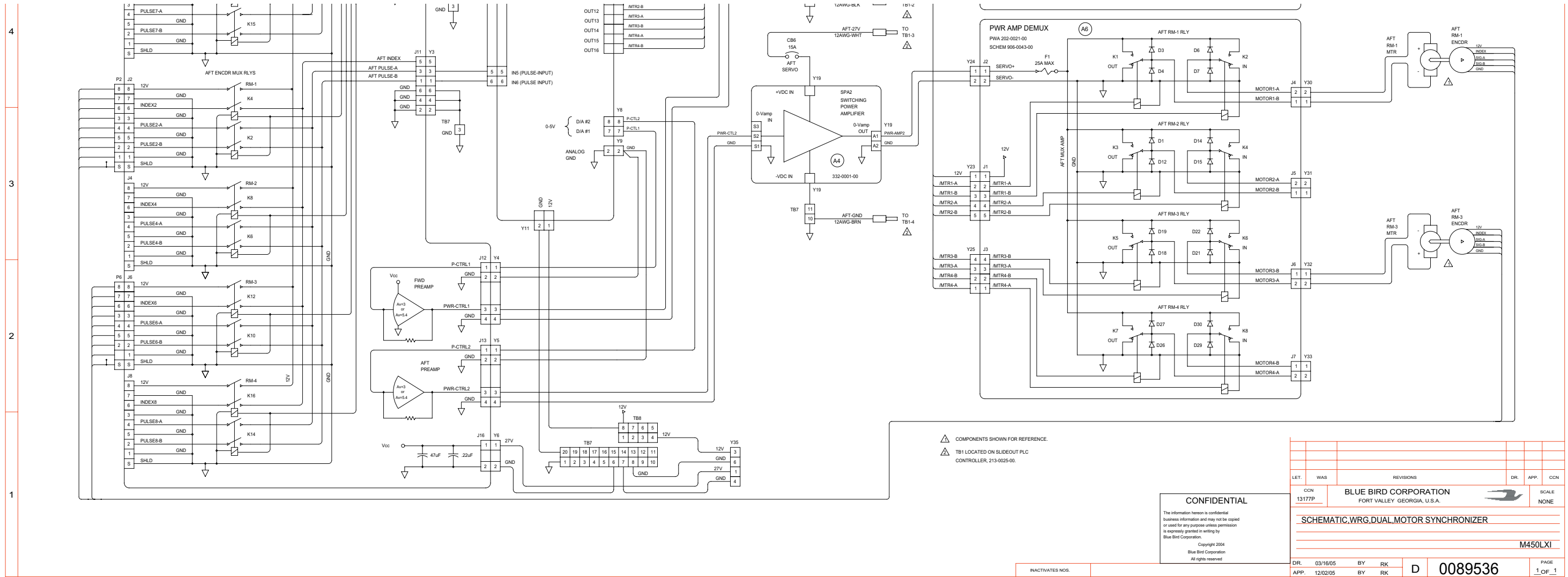

Wiring Schematic 0089537 - Schematic, Wiring, Slideout, PLC Controller, 4-Room - Page 1 of 5

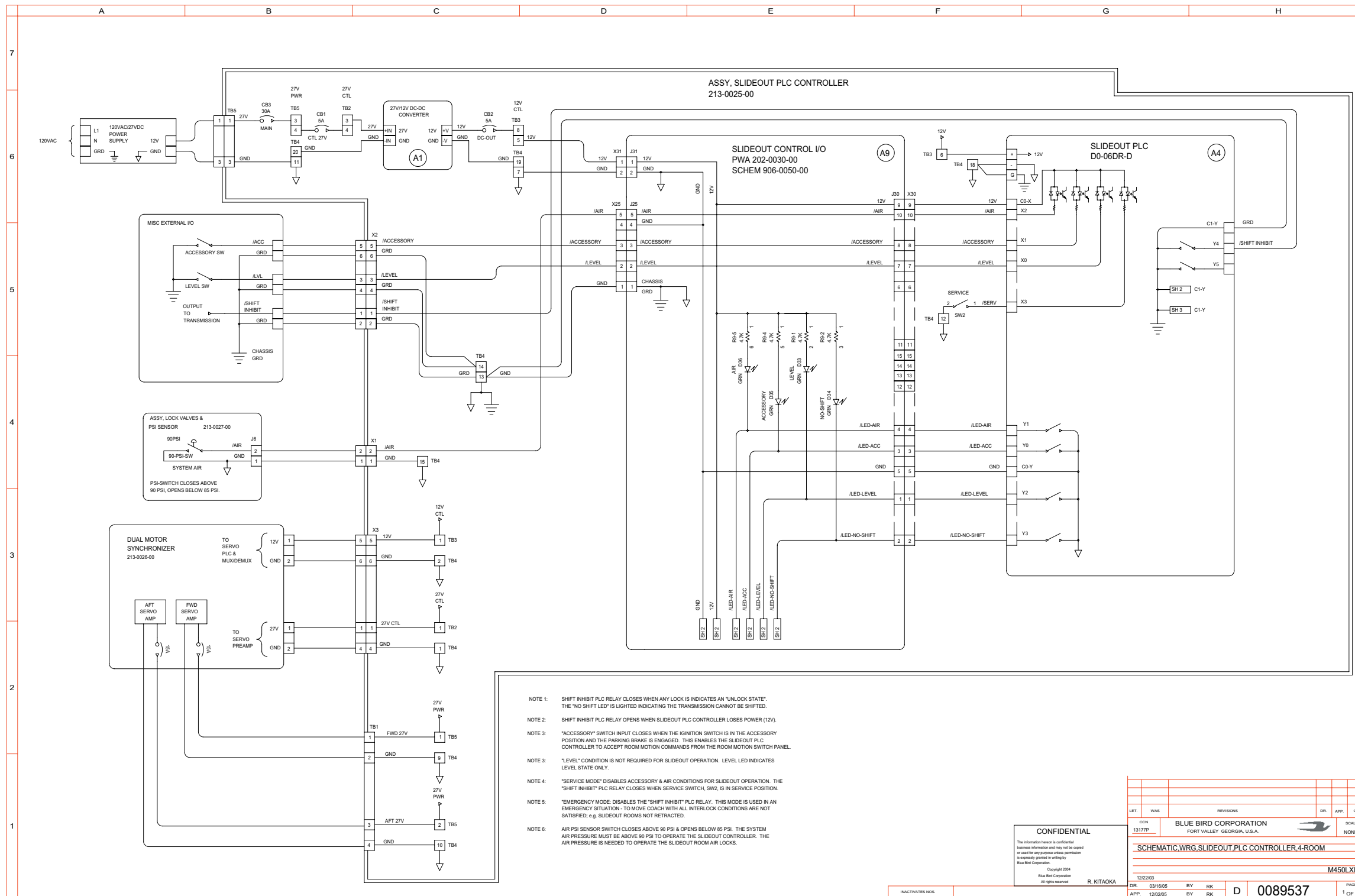



Wiring Schematic 0089537 - Schematic, Wiring, Slideout, PLC Controller, 4-Room - Page 2 of 5

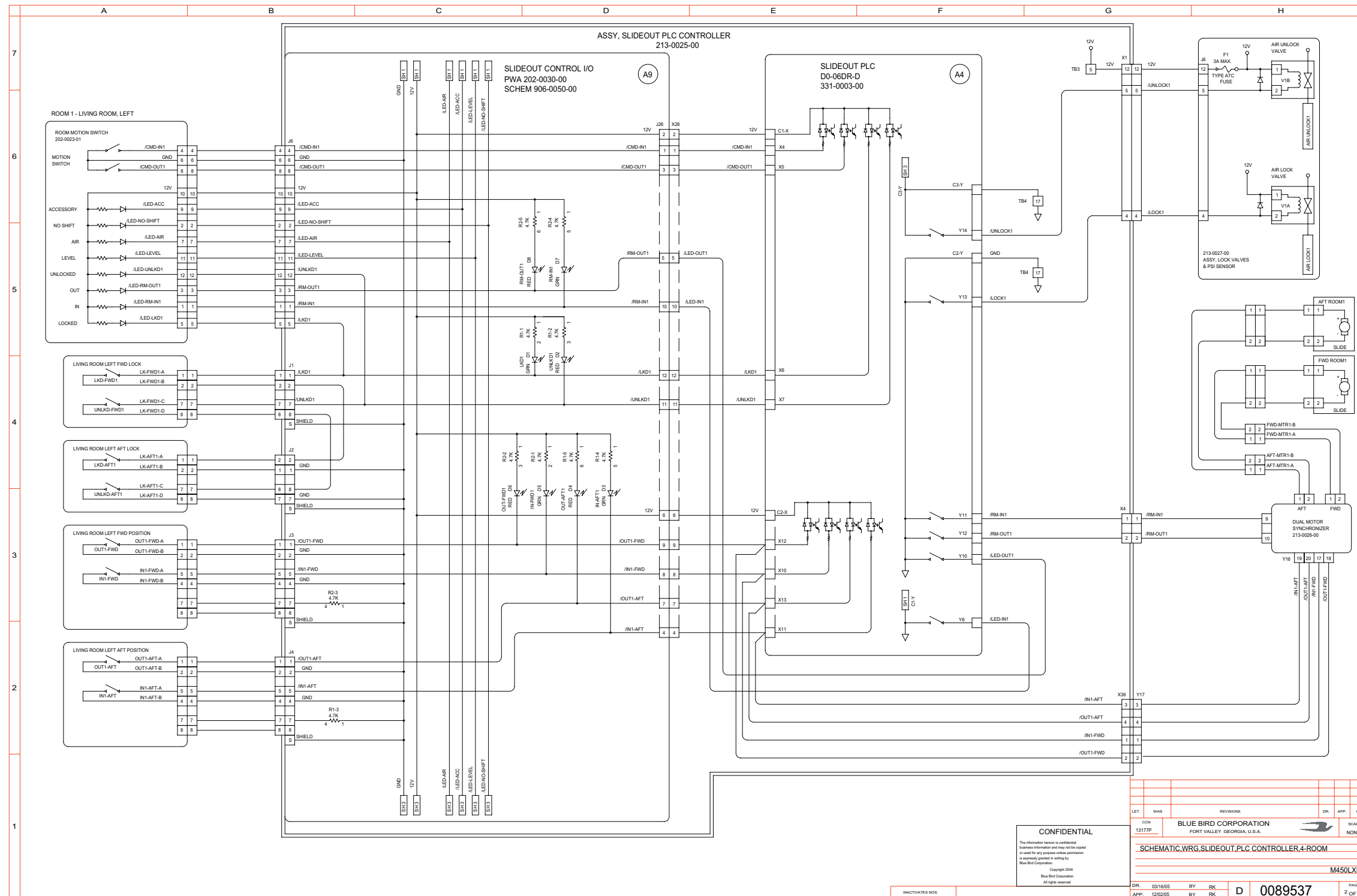

CONFIDENTIAL		BLUE BIRD CORPORATION		DR. APP. CCN	
The information herein is confidential business information and may not be used or sold for any purpose unless permission is expressly granted in writing by Blue Bird Corporation.		FORT VALLEY, GEORGIA, U.S.A.		SCALE NONE	
Copyright 2006 Blue Bird Corporation All rights reserved.		SCHEMATIC.WRG.SLIDEOUT.PLC.CONTROLLER.4-ROOM		M450LXI	
DR. 03/16/05	BY: RK	APP. 12/02/05	BY: RK	D 0089537	PAGE 2 OF 5

Wiring Schematic 0089537 - Schematic, Wiring, Slideout, PLC Controller, 4-Room - Page 2 of 5 - **Exploded View A**

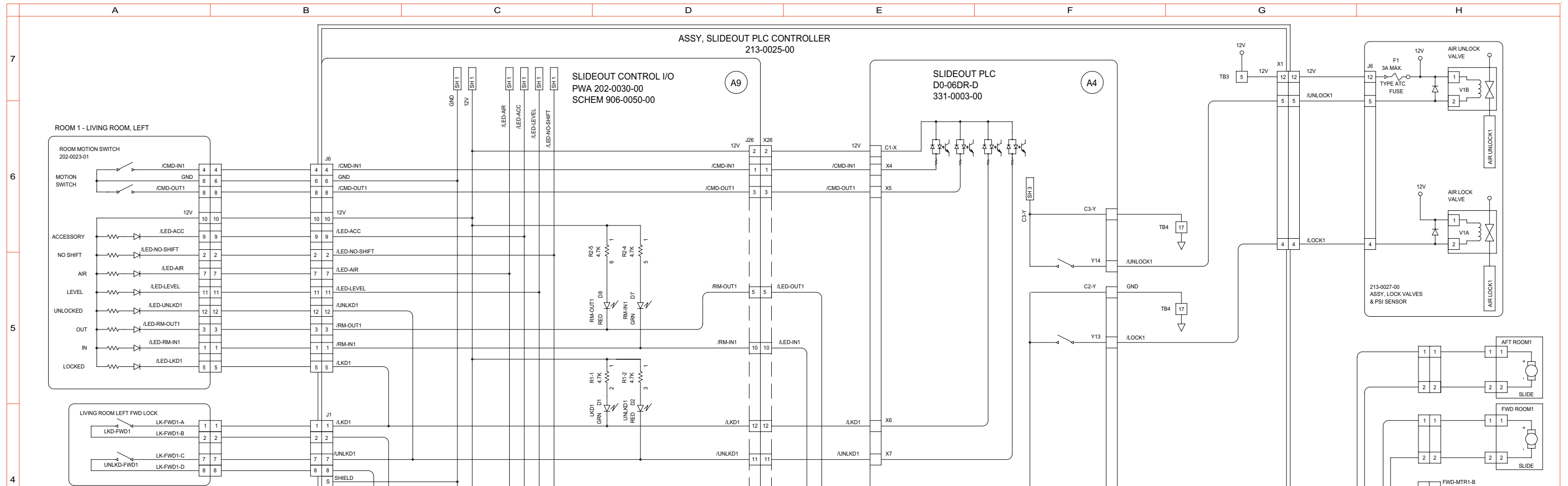

Wiring Schematic 0089537 - Schematic, Wiring, Slideout, PLC Controller, 4-Room - Page 2 of 5 - Exploded View B

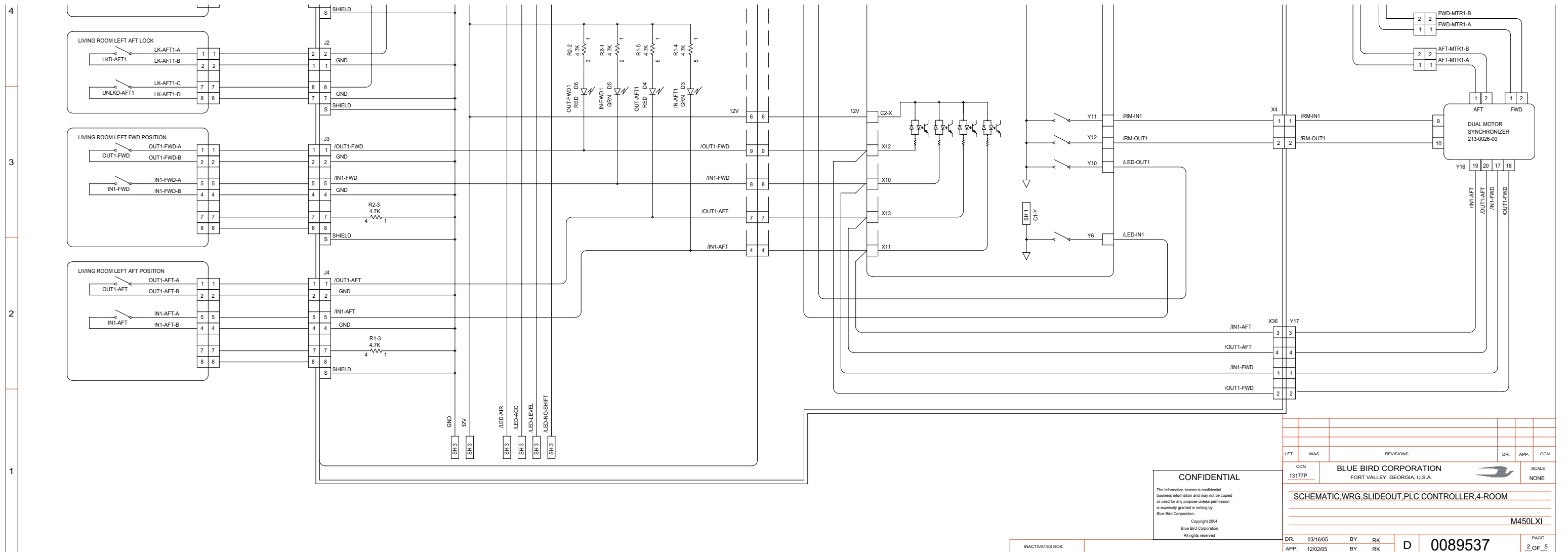

LET.	WAS	REVISIONS	DR.	APP.	CCN
CCN	13177P	BLUE BIRD CORPORATION FORT VALLEY, GEORGIA, U.S.A.			SCALE NONE
SCHEMATIC, WRG, SLIDEOUT, PLC CONTROLLER, 4-ROOM					
M450LXI					
DR.	03/16/05	BY	RK	D	0089537
APP.	12/02/05	BY	RK		PAGE 2 OF 5

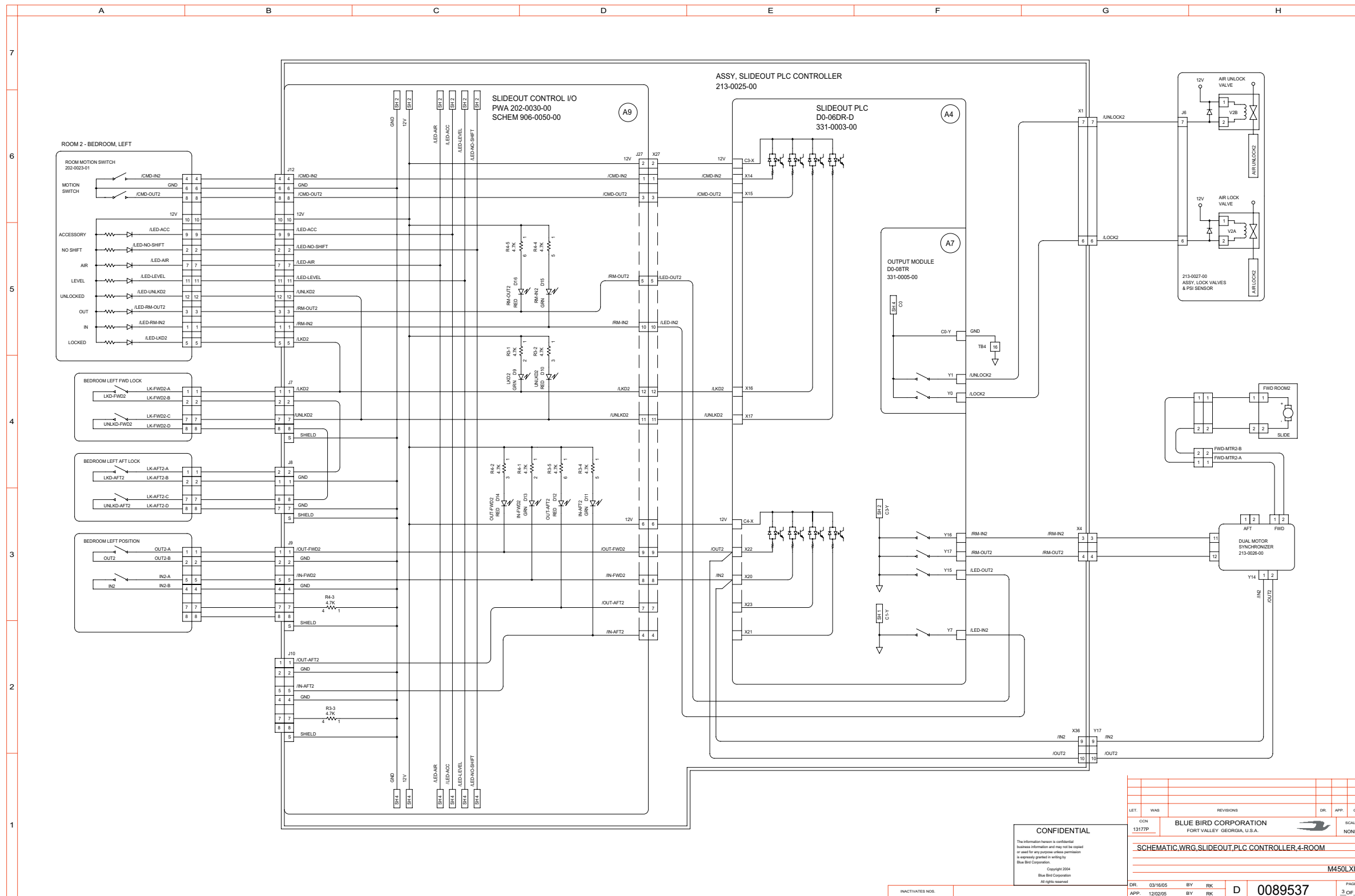

**CONFIDENTIAL**  
The information herein is confidential business information and may not be copied or used for any purpose without permission. It is expressly granted in writing by Blue Bird Corporation.  
Copyright 2004  
Blue Bird Corporation  
All rights reserved.

LET.	WAS	REVISIONS	DR.	APP.	CCN
CCN	13177P				
BLUE BIRD CORPORATION FORT VALLEY, GEORGIA, U.S.A.					
SCHEMATIC.WRG.SLIDEOUT.PLC.CONTROLLER.4-ROOM					
M450LXI					
DR.	03/15/05	BY	RK		
APP.	12/02/05	BY	RK	D	0089537
					PAGE: 3 OF 5

Wiring Schematic 0089537 - Schematic, Wiring, Slideout, PLC Controller, 4-Room - Page 4 of 5

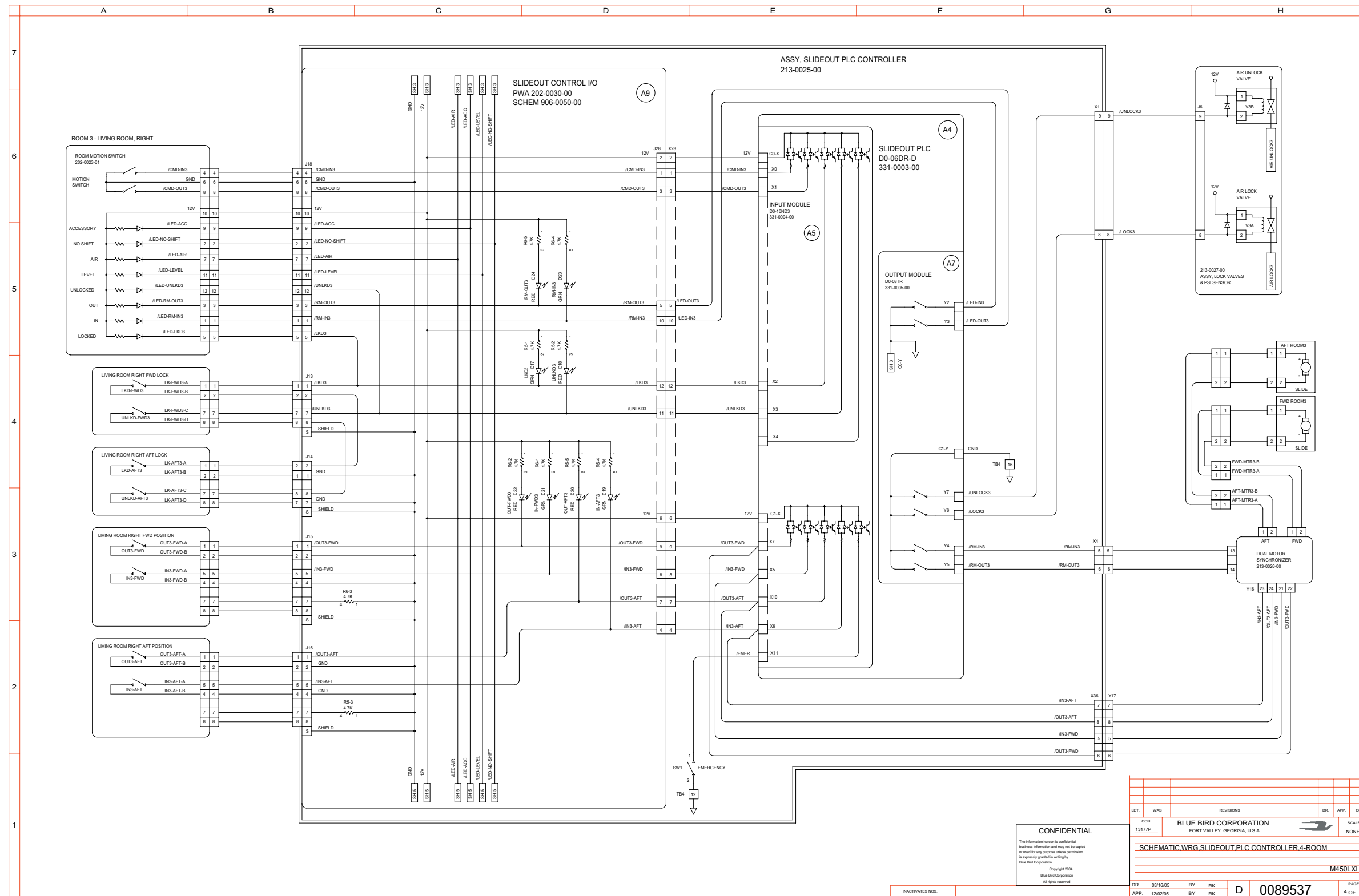

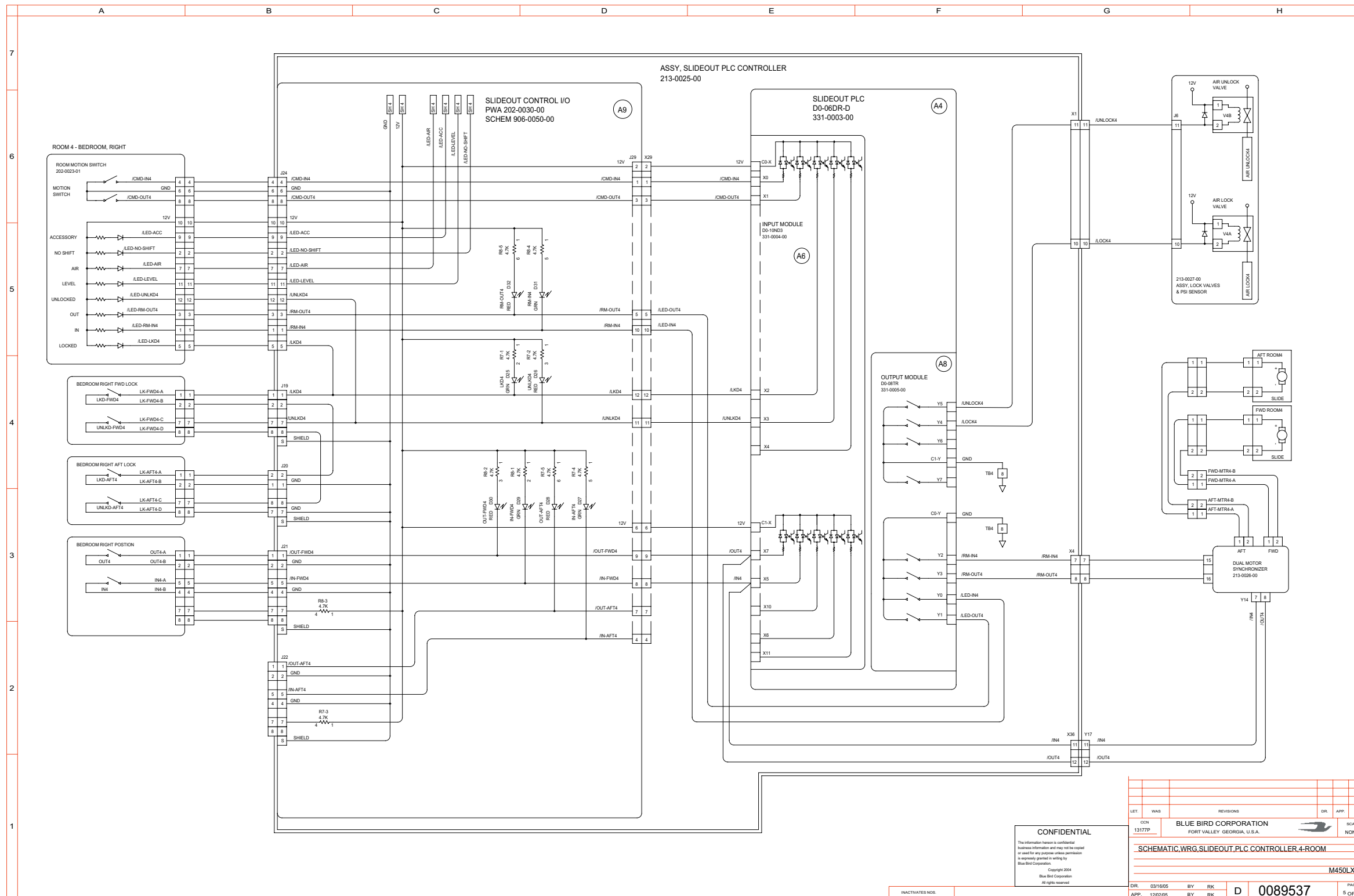

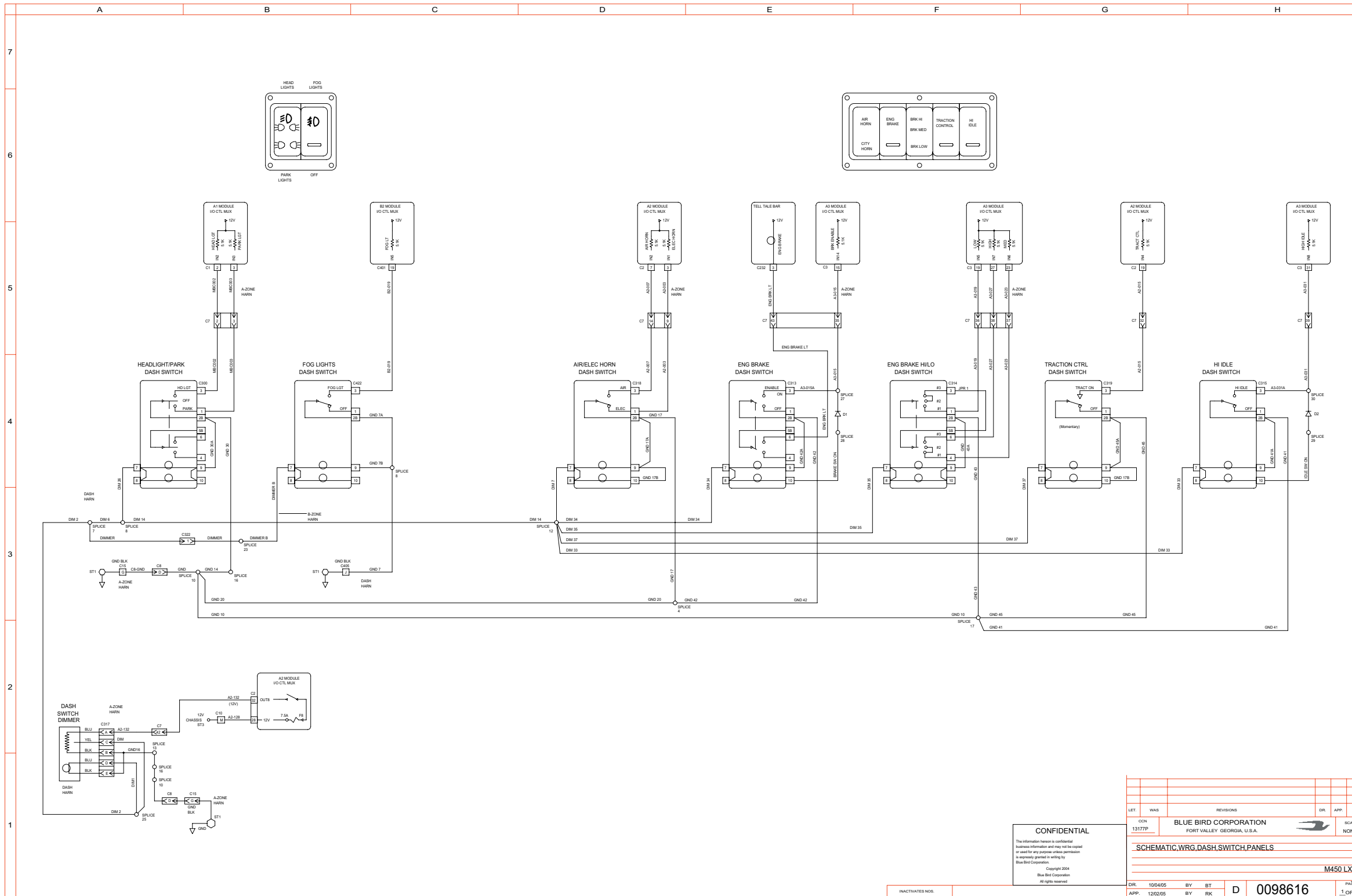

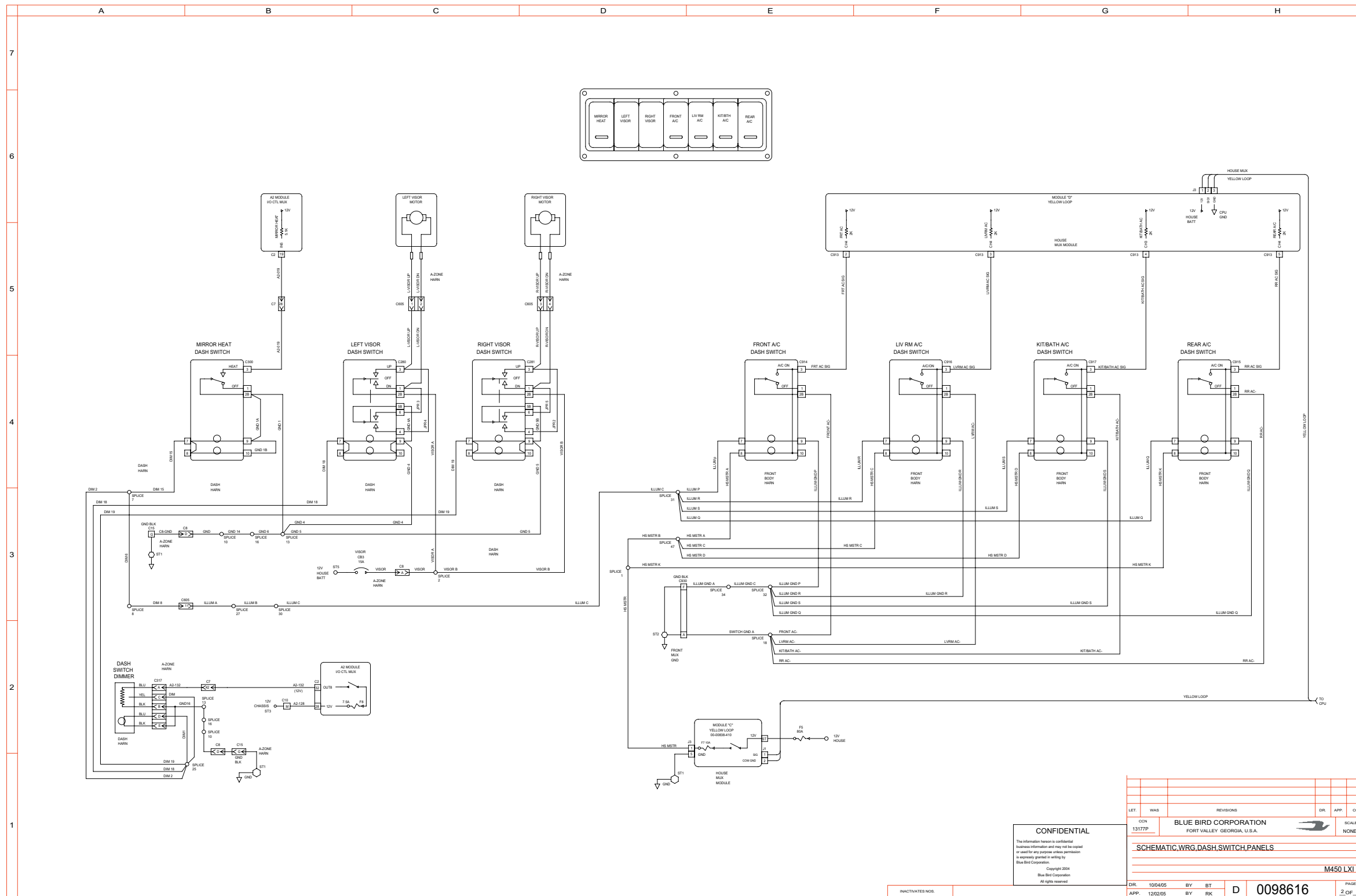

**CONFIDENTIAL**  
 This information is confidential.  
 Business information and may not be copied  
 or used for any purpose without permission.  
 It is hereby granted in writing by  
 Blue Bird Corporation.  
 Copyright 2004  
 Blue Bird Corporation  
 All rights reserved.

LET	WAS	REVISIONS	ENR	APP	CCN
CCN	13177D	BLUE BIRD CORPORATION FORT VALLEY GEORGIA, U.S.A.			SCALE NONE
SCHEMATIC.WRG.DASH.SWITCH.PANELS					
M450 LXi					
DR.	10/04/05	BY	BT	D	0098616
APP.	12/02/05	BY	RK		PAGE 2 OF 7



Wiring Schematic 0098616 - Schematic, Wiring, Dash, Switch Panels - Page 3 of 7

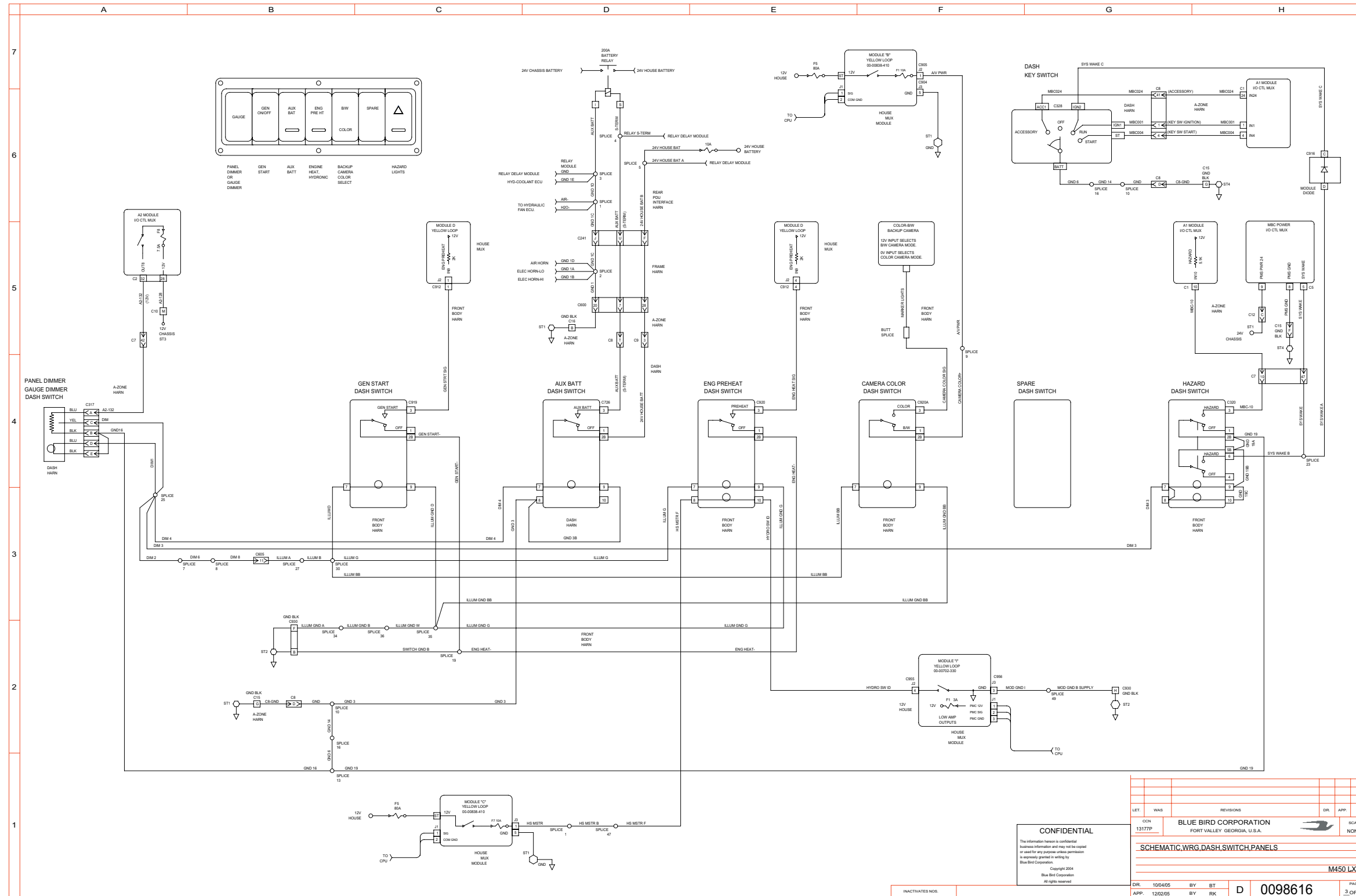

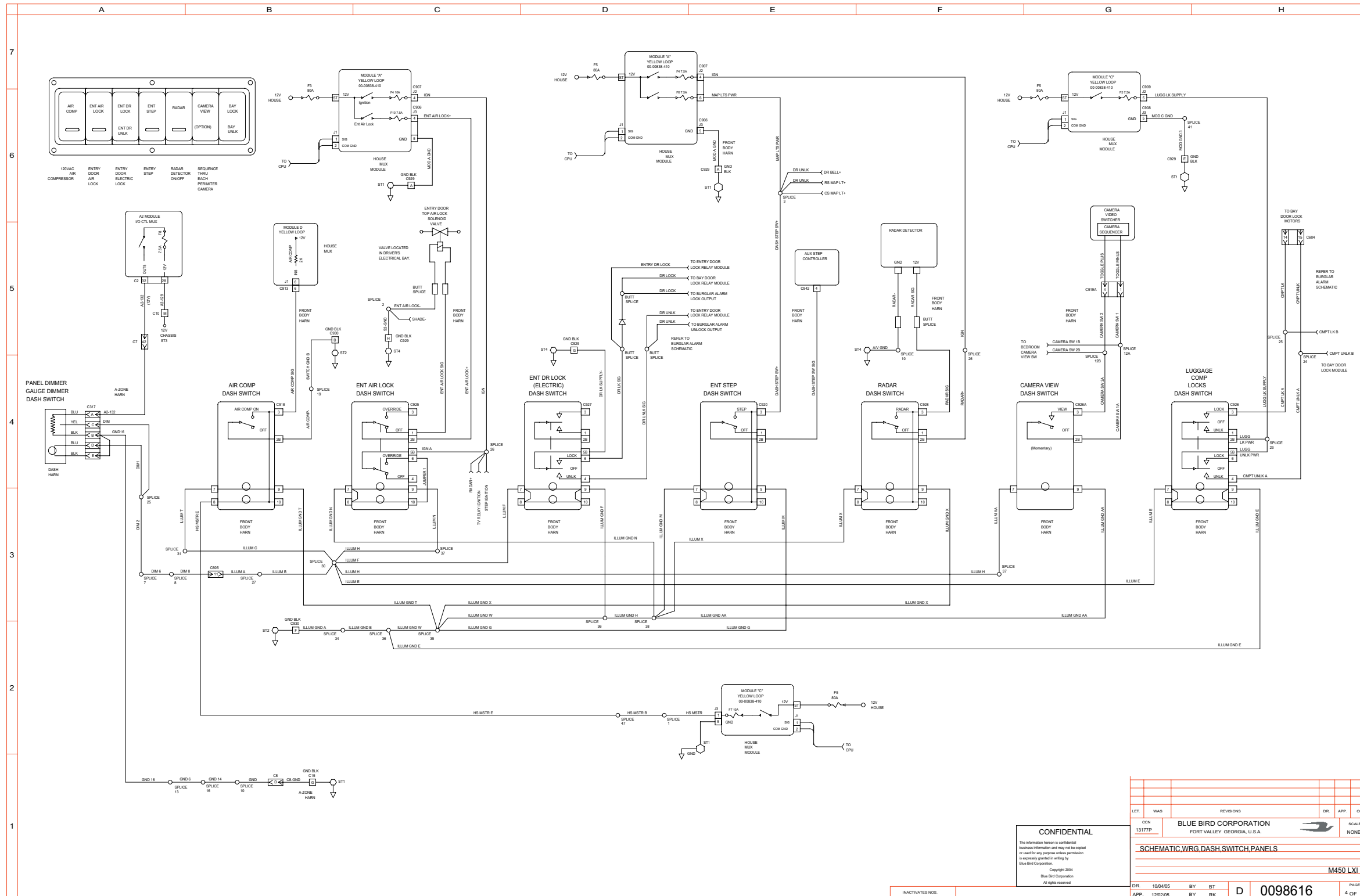

LET	WAS	REVISIONS	ENR	APP	CCN
CCN	13177D	BLUE BIRD CORPORATION FORT VALLEY GEORGIA, U.S.A.			SCALE NONE
SCHEMATIC.WRG.DASH.SWITCH.PANELS					
M450 LXI					
DR	10/04/05	BY	BT	D	0098616
APP	12/02/05	BY	RK		PAGE 4 OF 7

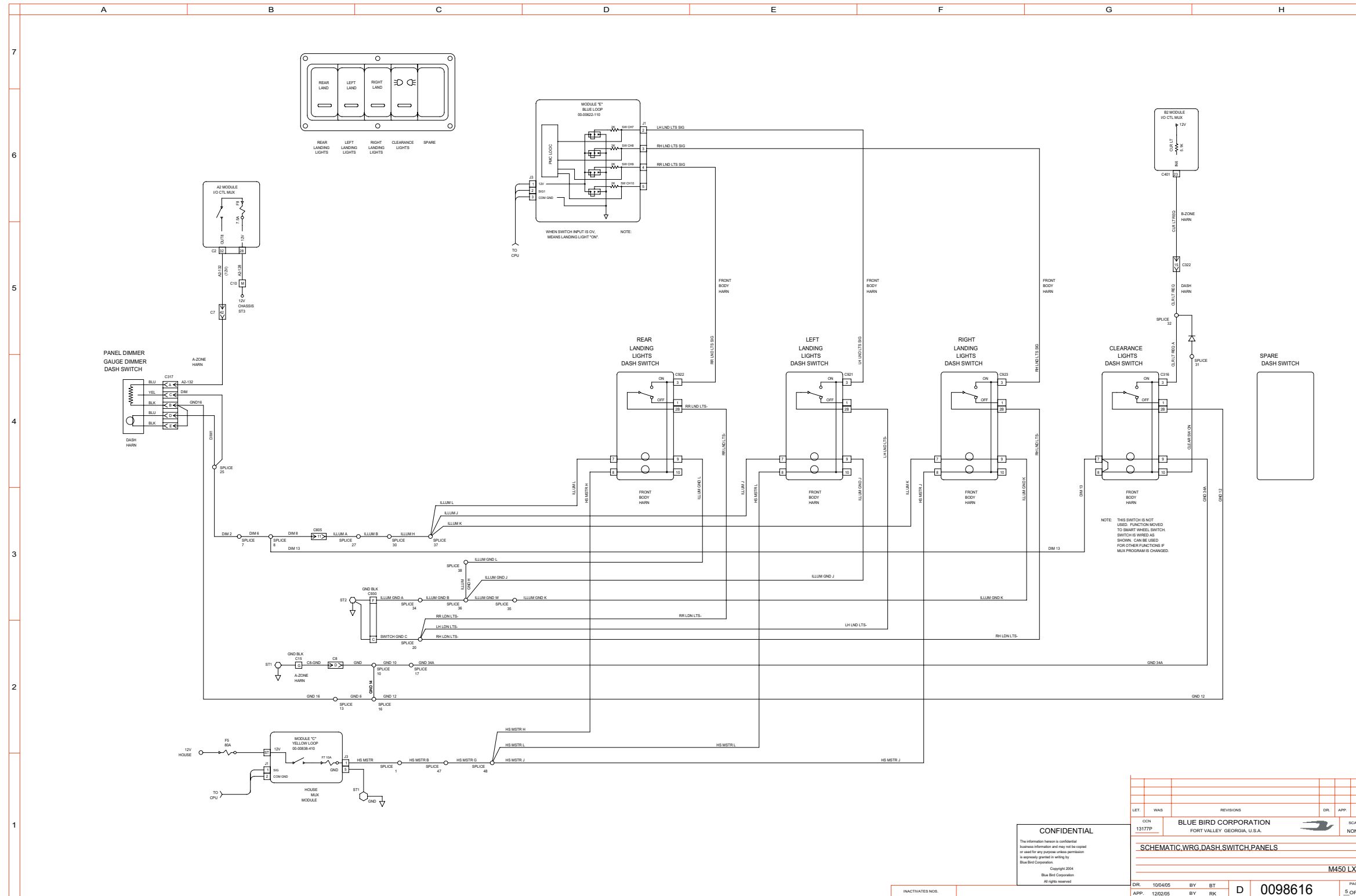

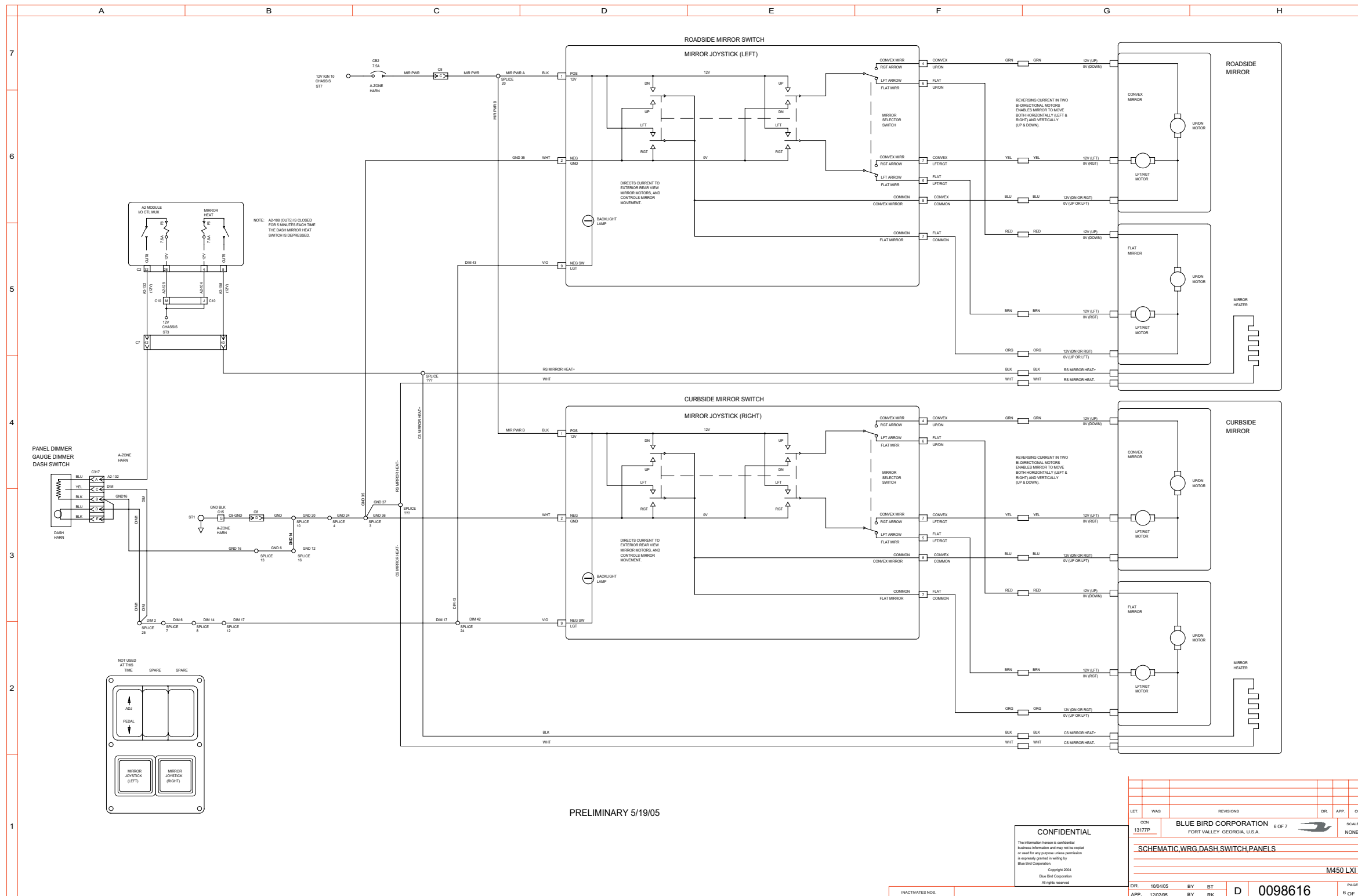

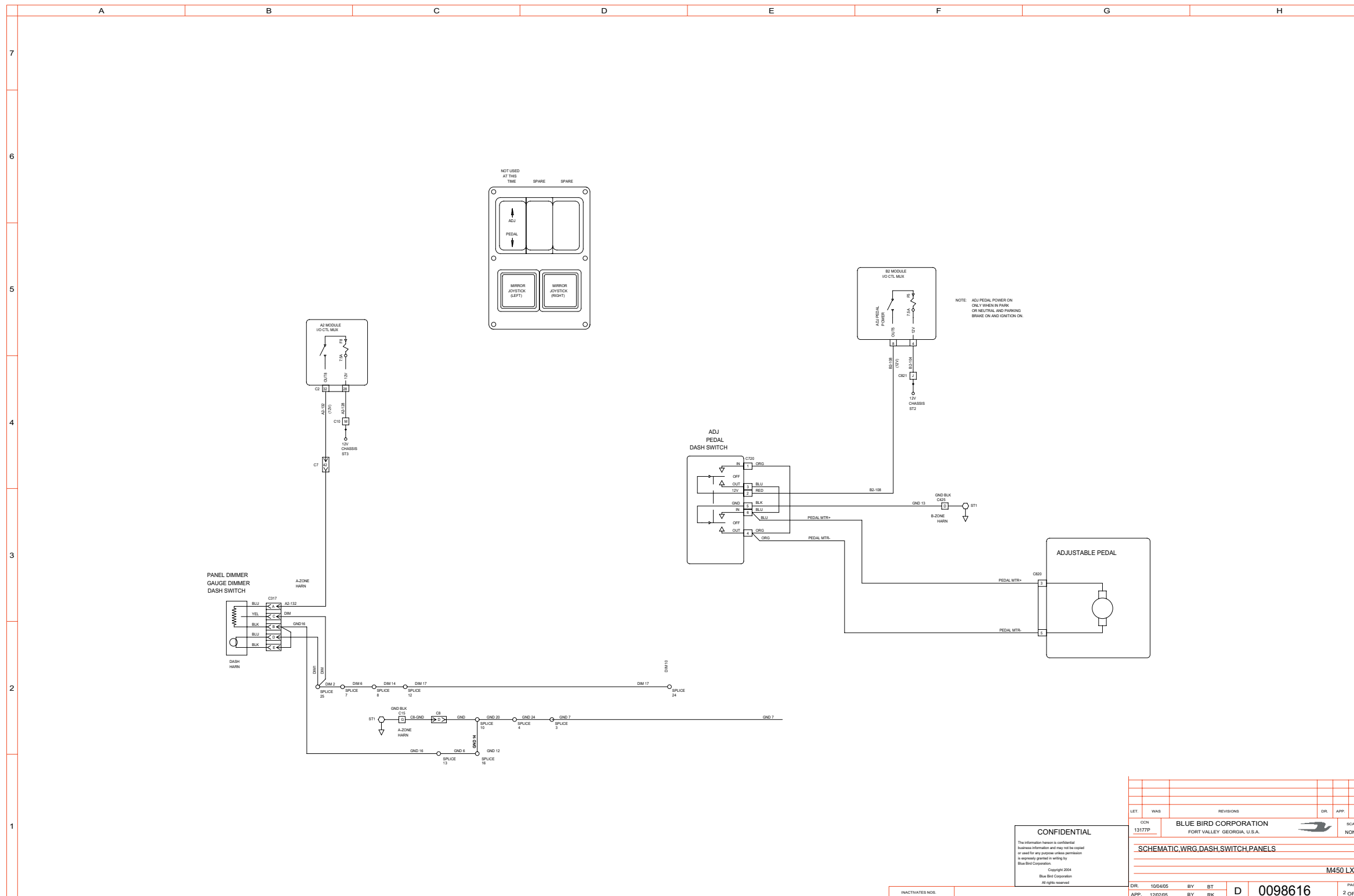

Wiring Schematic 0099998 - Schematic, Pneumatic, Air Lock Valves, PSI Sensor

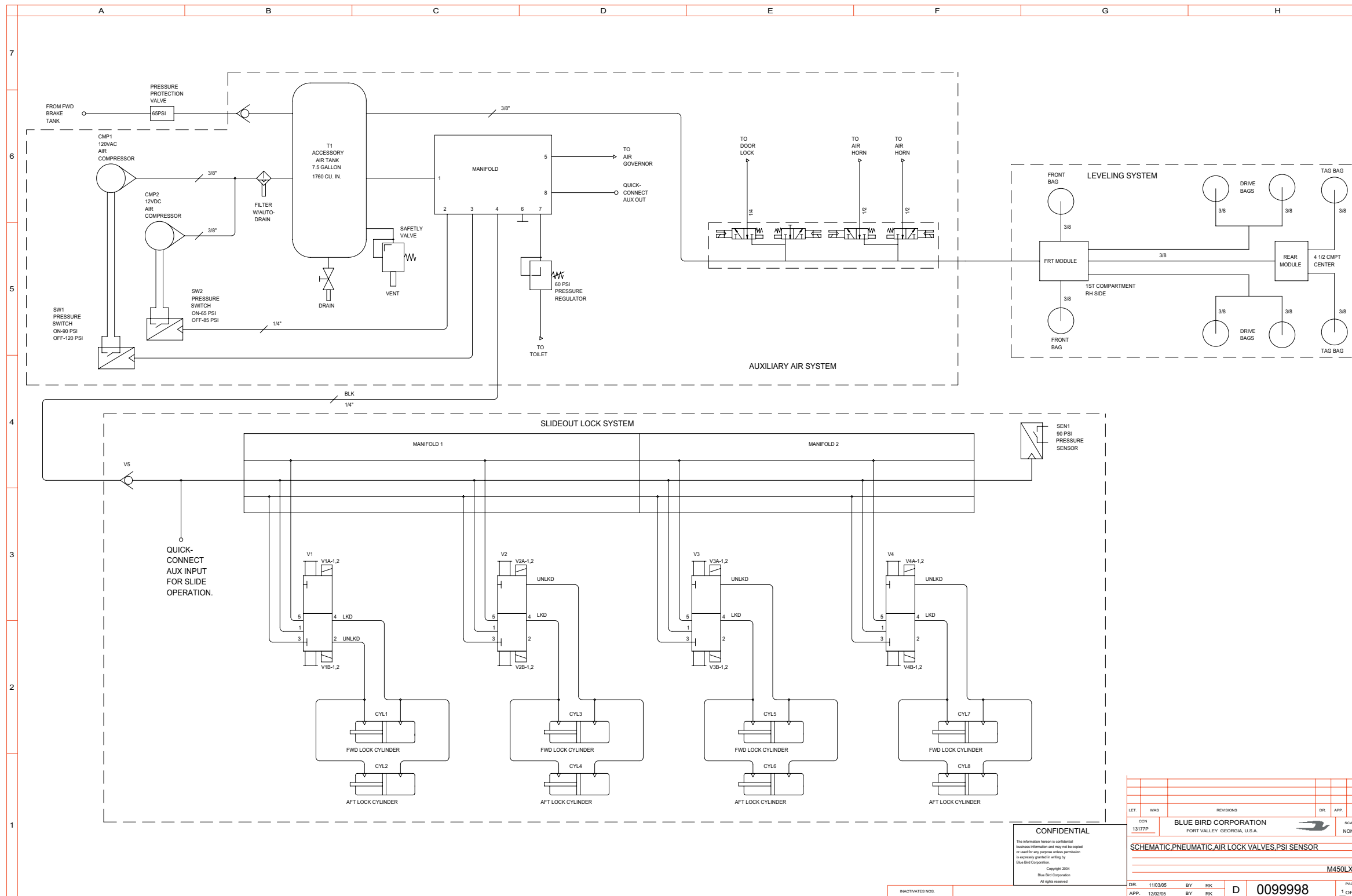

**CONFIDENTIAL**  
 The information herein is confidential  
 business information and may not be copied  
 or used for any purpose without permission  
 in writing from Blue Bird Corporation.  
 Copyright 2004  
 Blue Bird Corporation  
 All rights reserved

LET	WAS	REVISIONS	ENR	APP	CCN
CCN	13177D	BLUE BIRD CORPORATION FORT VALLEY, GEORGIA, U.S.A.			SCALE NONE
SCHEMATIC, PNEUMATIC, AIR LOCK VALVES, PSI SENSOR					
M450LXI					
DR.	11/03/05	BY	RK	D	0099998
APP.	12/02/05	BY	RK		PAGE 1 OF 1

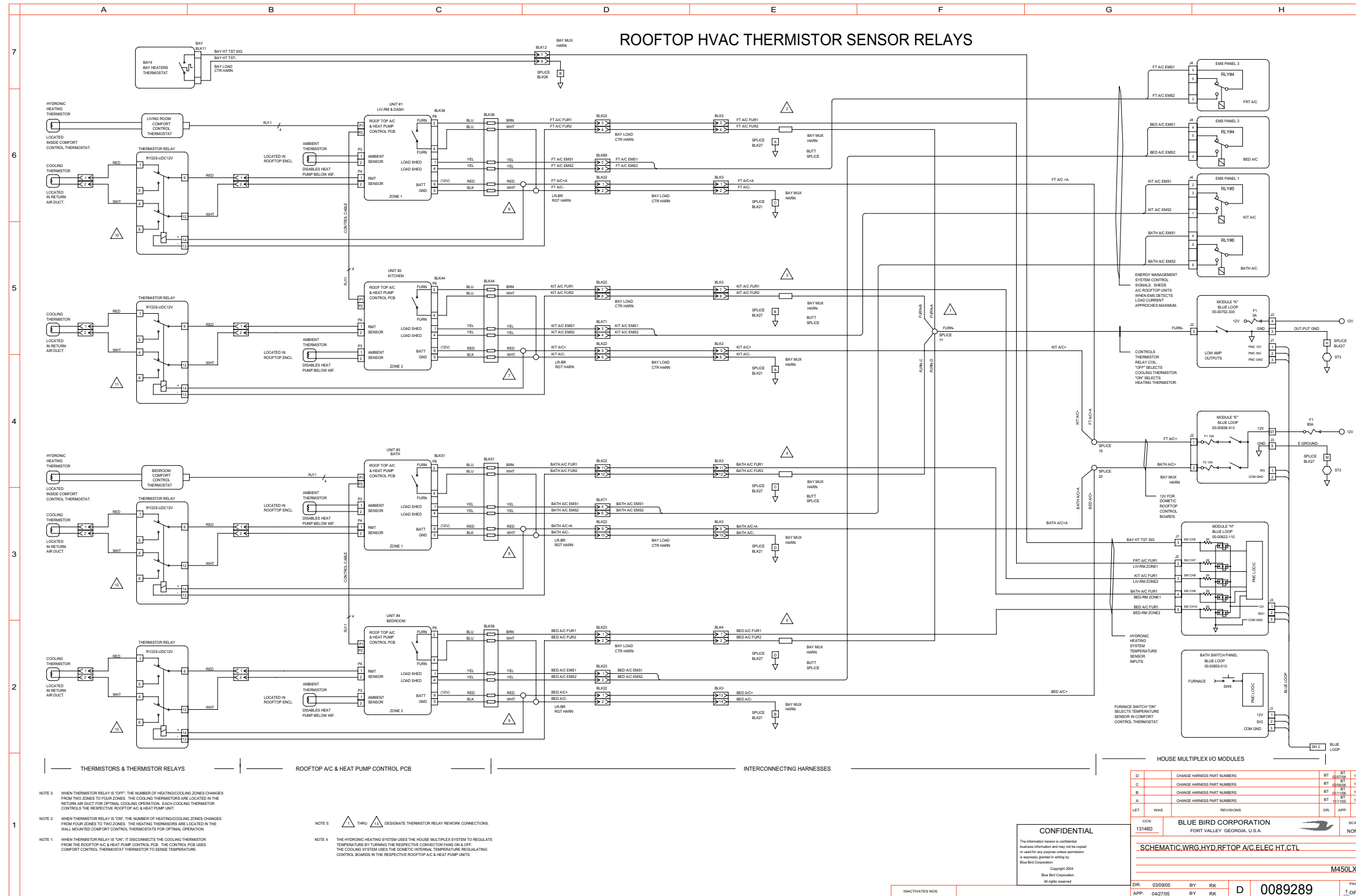

Wiring Schematic 0089289 - Schematic, Wiring, Hyd, Rftop A/C, Elec. Ht, Ctl. - Page 2 of 5

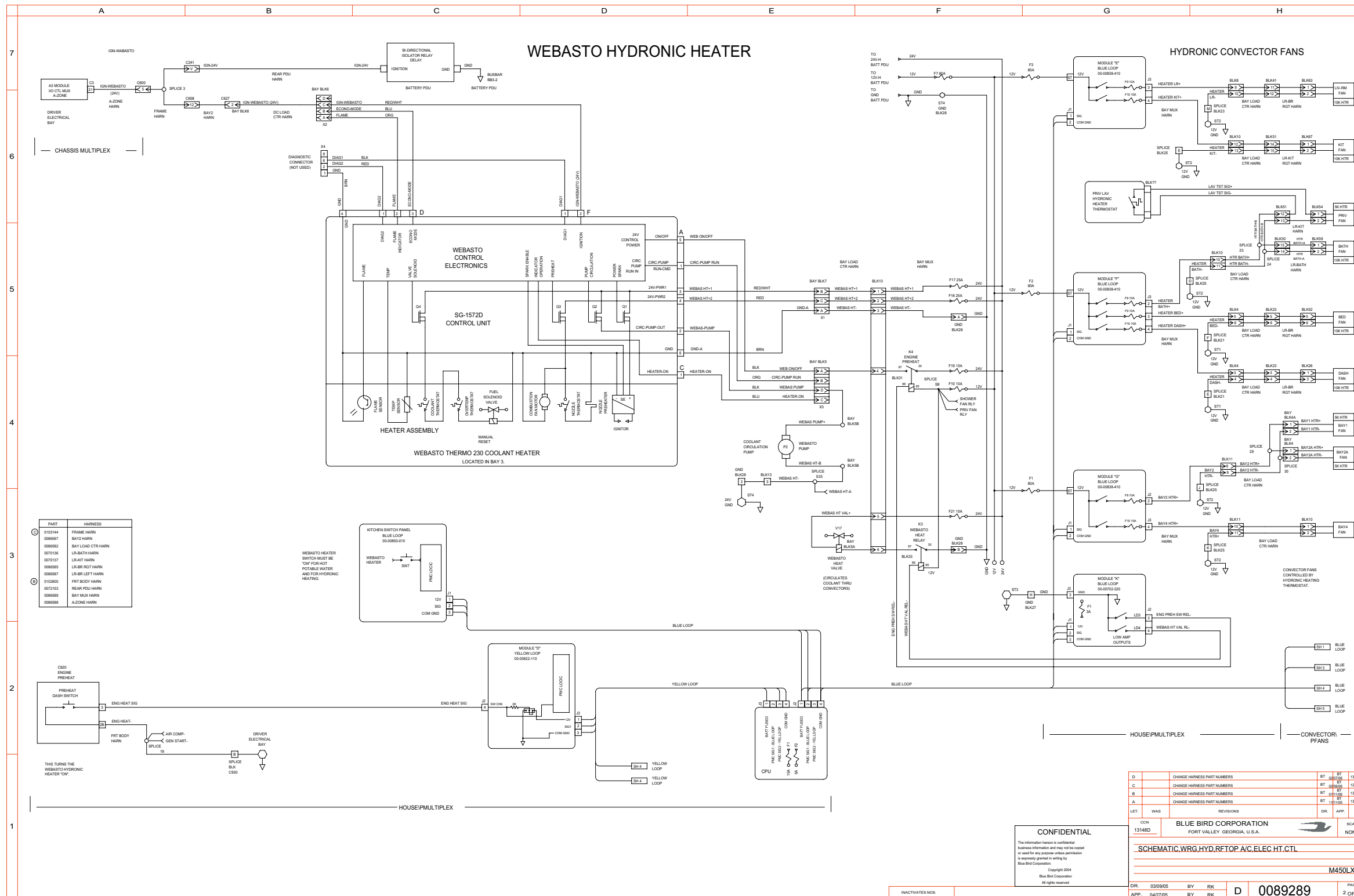



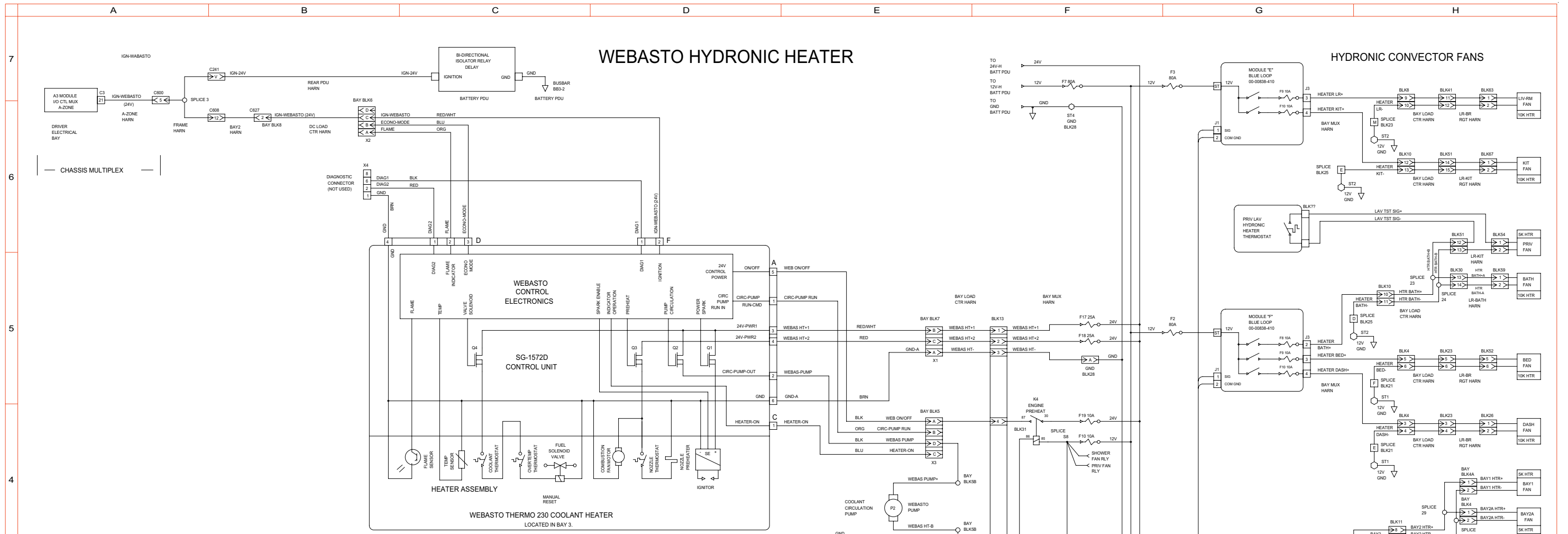

Wiring Schematic 0089289 - Schematic, Wiring, Hyd, Rftop A/C, Elec. Ht, Ctl. - Page 2 of 5 - Exploded View B

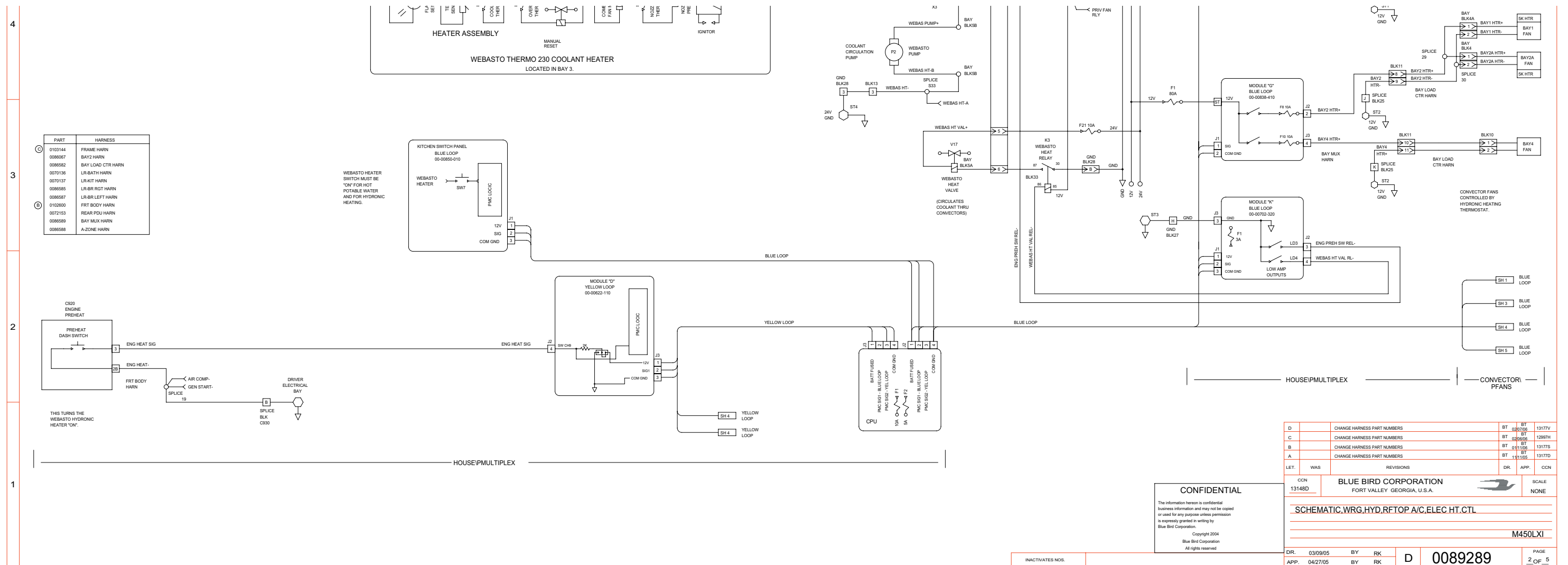

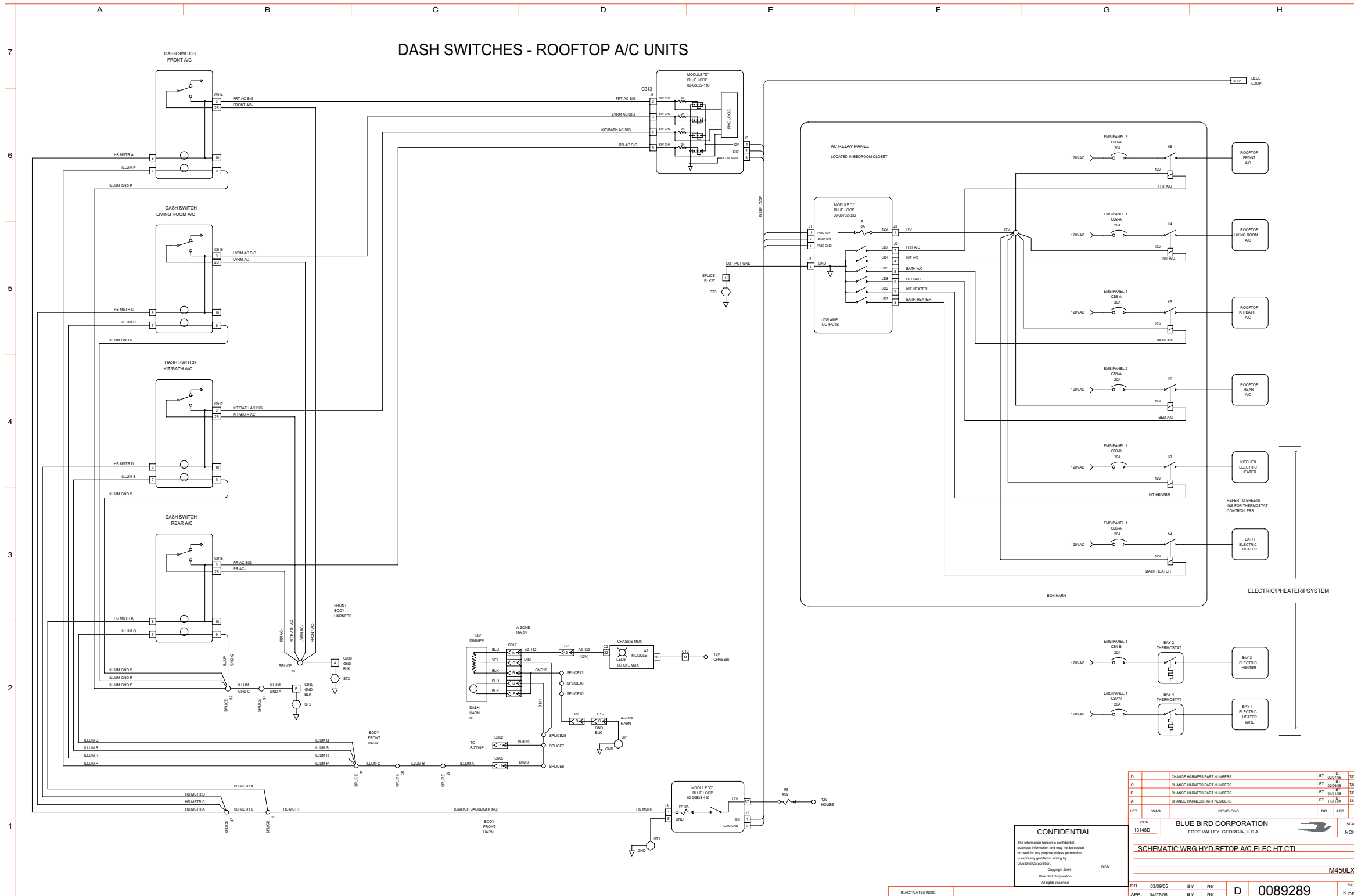

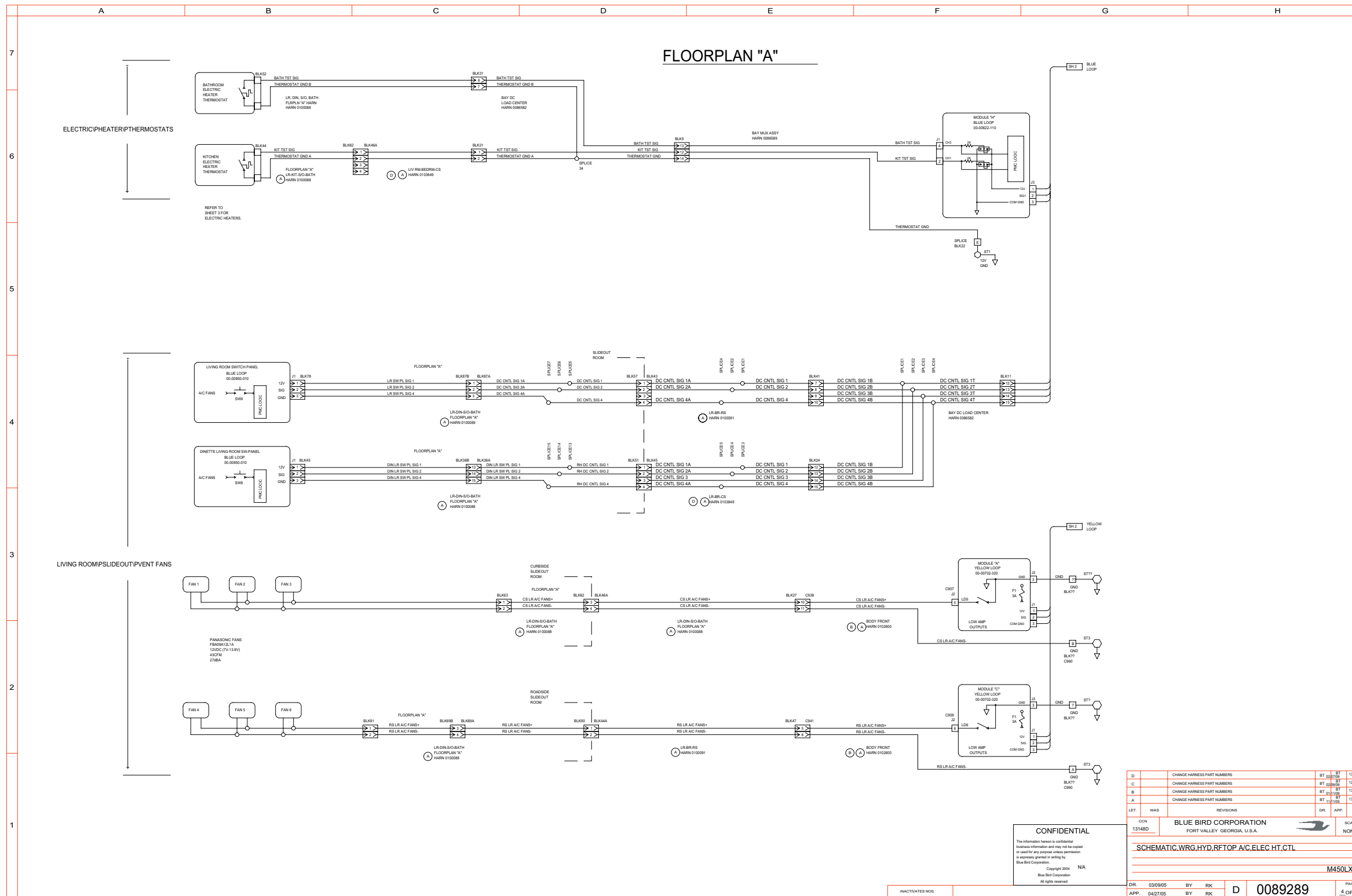

Wiring Schematic 0089289 - Schematic, Wiring, Hyd, Rftop A/C, Elec. Ht, Ctl. - Page 5 of 5

