

EUCLID

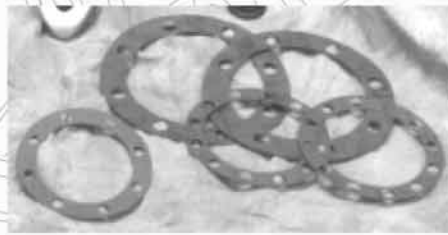



WHEEL ATTACHING PARTS SECTION FOUR

INDEX

Wheel and Hub Parts	Page
Drive Flange Studs.....	4-36
Drive Flange Studs - Metric	4-41
Hub Cap O-Ring.....	4-77
Hub Cap Plugs	4-77
Brake Drum Attaching Screw	4-42
Bus and Heavy Duty Studs	4-13
Disc Wheel Nuts.....	4-3
Drive Flange Nuts	4-41
Drive Flange Wedges.....	4-41
Drum Bolt Assemblies.....	4-42
Gaskets	4-78
Hub Caps	4-76
Inner Cap Nuts	4-1
Rim Clamps.....	4-44
Shoulder Studs.....	4-9
Spindle Hardware - Steer Axle.....	4-62
Spindle Hardware - Trailer Axle	4-57
Spindle Nuts & Washers Assortments	4-75
Spindle Nuts - Drive Axle	4-67
Spoke Trailer Wheels.....	4-56
Spoke Wheel and Rim Bolts	4-44
Spoke Wheel and Rim Studs	4-42
Wheel Hub Application & Stud Selection Chart	4-53
Wheel Nuts.....	4-7
Wheel Service Information.....	4-51
Wheel Studs.....	4-15
Wheel Studs - Metric.....	4-32



INNER CAP NUTS

FOR DUAL MOUNTED STEEL AND STEEL/ALUMINUM WHEELS

	EUCLID NO.	REPLACES	OUTER THREAD SIZE	INNER THREAD SIZE	INNER THREAD MIN. DEPTH	OUTER OVERALL LENGTH	APPLICATION & GENERAL INFORMATION	
<p style="text-align: center;">O.E. STANDARD FOR DUAL STEEL WHEELS</p> 	E-7895-L	Budd 10709, 3203404 Webb 107083, 107091 Meritor 1199K115 Reyco 30007 Std. Forge 303101 Navistar 41420V Trailmobile 50-34B-2 Fruehauf 534767 Alcoa 5549L Motor Wheel 84526 Fruehauf MWCX01829 Nwra X-1829	1-1/8"-16	3/4"-16	1-1/4"	2-7/32"	Through Hardened. Zinc Yellow Dichromate Plating	
	E-7895-R	Budd 10708, 3203403 Webb 107080, 107082 Meritor 1199J114 Reyco 30006 Std. Forge 303100 Navistar 41419V Trailmobile 50-34B-1 Fruehauf 534766 Alcoa 5549R Motor Wheel 84525 Fruehauf MWCX01828 Nwra X-1828						
<p style="text-align: center;">O.E. STANDARD FOR STEEL INNER AND ALUMINUM OUTER WHEELS</p> 	E-7896-L	Budd 3203402, 35337 Alcoa 5735L Fruehauf MWCX01836 Nwra X-1836				2-9/16"	Through Hardened	
	E-7896-R	Budd 3203401, 35336 Alcoa 5735-R Fruehauf MWCX01835 Nwra X-1835						
	E-7897-L	Meritor 1199G969 Navistar 129302R1 Budd 22622, 88014 Trailmobile 38-7897-L Trailmobile 700-7-80 Navistar 898376R1 Wagner 916105 Nwra X-1408				1-7/8"		3-1/16"
	E-7897-R	Meritor 1199F968 Navistar 129303R1 Budd 22621, 88013 Trailmobile 700-7-78 Navistar 898375R1 Nwra X-1407 Nwra X2122						

INNER CAP NUTS

FOR DUAL MOUNTED STEEL AND STEEL/ALUMINUM WHEELS

	EUCLID NO.	REPLACES	OUTER THREAD SIZE	INNER THREAD SIZE	INNER THREAD MIN. DEPTH	OUTER OVERALL LENGTH	APPLICATION & GENERAL INFORMATION
O.E. STANDARD FOR OFF-HIGHWAY APPLICATIONS 	E-7898-L	Meritor 1199W1349 Fruehauf 226604 Budd 3204504 Budd 49415 Trailmobile 50-34B-12 Alcoa 5575L Navistar 698166R1 NWRA X-1412	1-5/16"-12	15/16"-12	1-7/8"	3"	Through Hardened. Zinc Yellow Dichromate Plating
	E-7898-R	Meritor 1199V1348 Fruehauf 226605 Budd 3204503 Budd 49414 Trailmobile 50-34B-11 Alcoa 5575R Midland 67266 Navistar 698165R1 NWRA X-1411					
IMPORT VEHICLES 	E-10253-L	Isuzu 1-42336-005-0 Hino 9004-24101	M30x1.5	M20x1.5	1-3/16"	2-7/16"	
	E-10253-R	Isuzu 1-42335-005-0 Hino 9004-23101					

FOR DUAL MOUNTED ALUMINUM WHEELS

	EUCLID NO.	REPLACES	OUTER THREAD SIZE	INNER THREAD SIZE	INNER THREAD MIN. DEPTH	OUTER OVERALL LENGTH	APPLICATION & GENERAL INFORMATION
O.E. STANDARD WITH FULL INNER THREADS FOR APPLICATIONS REQUIRING MAXIMUM THREAD ENGAGEMENT 	E-5978-L	Alcoa 5956-L Alcoa 5978-L Fruehauf MWCX01874 NWRA X-1874	1-1/8"-16	3/4"-16	1-15/16"	3-1/16"	Through Hardened
	E-5978-R	Alcoa 5956-R Alcoa 5978-R HDA 956LB/956RB Fruehauf MWCX01873 NWRA X-1873					

Zinc Clear Chromate plating unless otherwise stated.

INNER CAP NUTS





FOR DUAL MOUNTED ALUMINUM WHEELS

 <p>O.E. STANDARD FOR DUAL ALUMINUM WHEEL APPLICATION</p>	EUCLID NO.	REPLACES	OUTER THREAD SIZE	INNER THREAD SIZE	INNER THREAD MIN. DEPTH	OUTER OVERALL LENGTH	APPLICATION & GENERAL INFORMATION
	E-5988-L	Webb 105989 Meritor 3280S7871 Trailmobile 50-34B-6 Alcoa 5988-L Budd 70612 Fruehauf MWCX02139 NWRA X-2139	1-1/8"-16	3/4"-16	1-15/16"	3-1/16"	Through Hardened. Zinc Yellow Dichromate Plating
E-5988-R	Webb 105988 Trailmobile 36-105988 Alcoa 5988-R Budd 70611 Fruehauf MWCX02138 NWRA X-2138						

4

DISC WHEEL NUTS



CAP NUTS FOR SINGLE & DUAL MOUNTED WHEELS

	EUCLID NO.	REPLACES	THREAD	HEX	HIGH	APPLICATION & GENERAL INFORMATION
	E-10254-L	Isuzu 1-42334-023-0 Hino 9004-22104	M30x1.5	41mm	1"	For use with E-10253-L Metric inner cap nuts.
	E-10254-R	Isuzu 1-42333-023-0 Hino 9004-21112				
	E-4976-R	Budd 41233 Motor Wheel 81124 NWRA X-1146	9/16"-18	1"	11/16"	
	E-9012-L	Ford C7TZ1121A	9/16"-18	1-1/16"	2-1/32"	
	E-9012-R	Ford C7TZ1120A				
	E-4975-R	Budd 67147 NWRA X-1148	5/8"-18	1"	2-1/32"	
E-4979-R	Budd 47147	5/8"-18	1-1/16"	5/8"		
	E-5652-L	Meritor 1199G111 Autocar 11A366L Webb 178737 Budd 3205102, 37889 Trailmobile 50-34A-2 Motor Wheel 84524 Navistar 84712H Ford BB1121 Fruehauf MWCX01804 NWRA X-1804	3/4"-16	1-1/2"	7/8"	Single Mounting, Front or Rear
	E-5652-R	Meritor 1199H112 Autocar 11A366R Webb 178736 Budd 3205101, 37888 Trailmobile 50-34A-1 Motor Wheel 84523 Navistar 84711H Ford BB1120 Fruehauf MWCX01803 NWRA X-1803				

Zinc Clear Chromate plating unless otherwise stated.

DISC WHEEL NUTS

CAP NUTS FOR SINGLE & DUAL MOUNTED WHEELS

	EUCLID NO.	REPLACES	THREAD	HEX	HIGH	APPLICATION & GENERAL INFORMATION
	E-5554-L	Navistar 129300R1 Budd 3205302 Alcoa 5554-L Budd 70614 Fruehauf MWC-X01808 NWRA X-1808	3/4"-16	1-1/2"	1"	For Single Mounting of Alcoa Forged Aluminum Disc Wheels
	E-5554-R	Navistar 129301R1 Budd 3205301 Trailmobile 38-5554-R Budd 70613 Fruehauf MWC-X01807 NWRA X-1807				
	E-5995-L	Alcoa 5995-L Fruehauf MWC-05995L	3/4"-16	1-1/2"	1-3/8"	For Alcoa Wide Base Aluminum Wheels. "Long Grip" Cap Nut. Larger height provides greater lug wrench contact into wheel.
	E-5995-R	Alcoa 5995-R Fruehauf MWC-05995R				
	E-5977-L	Meritor 1199M117 Webb 178921 Budd 3203802 Trailmobile 50-34C-2 Alcoa 5552-L Navistar 83156H Motor Wheel 84528 Ford BB1135 Fruehauf MWCX01832 NWRA X-1832	1-1/8"-16	1-1/2"	7/8"	Forged Steel - Thru-Hardened. Zinc Yellow Dichromate Plating. Outer Dual or Large Stud Single Mounting. For Severe Service Application use E-5579-L. For Clear Zinc coating use E-5977LC.
	E-5977-R	Meritor 1199N118 Webb 178910 Budd 3203801 Trailmobile 50-34C-1 Alcoa 5552-R Navistar 83155H Motor Wheel 84527 Ford BB1134 Fruehauf MWCX01831 Firestone NTR25 NWRA X-1831				



an **ArvinMeritor**™ brand

DISC WHEEL NUTS

CAP NUTS FOR SINGLE & DUAL MOUNTED WHEELS

	EUCLID NO.	REPLACES	THREAD	HEX	HIGH	APPLICATION & GENERAL INFORMATION
	E-5996-L	Alcoa 5996-L	1-1/8"-16	1-1/2"	1"	For Alcoa Wide Base Aluminum Wheels. "Long Grip" Cap Nut. Larger height provides greater lug wrench contact into wheel.
	E-5996-R	Alcoa 5996-R				

FLANGED CAP NUTS FOR SINGLE & DUAL MOUNTED WHEELS

	EUCLID NO.	REPLACES	THREAD	HEX	HIGH	APPLICATION & GENERAL INFORMATION
	E-5578-L	Trailmobile 50-34C-10 Budd 71737 NWRA X-1419	3/4"-16	1-1/2"	1-3/32"	Single Mounting Front or Rear. Provides Extra Mounting Strength for Vehicles in Severe Service.
	E-5578-R	Trailmobile 50-34C-9 Budd 71736 NWRA X-1418				
	E-5579-L	Meritor 1199Q1811 Autocar 11E48L Budd 3205202 Navistar 425282R1 Trailmobile 50-34C-6 Budd 69913 Trailmobile 700-7-82 NWRA X-1421	1-1/8"-16			Outer Dual or Large Stud Single Mounting. Provides Extra Mounting Strength for Vehicles in Severe Service.
	E-5579-R	Meritor 1199R1812 Autocar 11E48R Budd 3205201 Navistar 425283R1 Trailmobile 50-34C-5 Budd 69912 Trailmobile 700-7-81 NWRA X-1420				

4

FOR HEAVY-DUTY "OFF-HIGHWAY" SERVICE

	EUCLID NO.	REPLACES	THREAD	HEX	HIGH	APPLICATION & GENERAL INFORMATION
	E-6060-L	Meritor 1199C1433 Budd 67012 Navistar 974745R1 NWRA X-1363	1-1/8"-16	1-3/4"	1"	Special nut for adapting heavy-duty off highway wheels to standard 1-1/8" thread studs.
	E-6060-R	Meritor 1199B1432 Budd 67011 Navistar 974746R1 NWRA X-1362				
	E-5576-L	Meritor 1199-Y-1351 Autocar 11CD48L Budd 3204502 Budd 49417 Trailmobile 50-34C-14 Navistar 698168R1 NWRA X-1417	1-5/16"-12	1-3/4"	1-3/8"	Single or Outer Cap Nuts May Be Used With Accuride "Duplex" Wheels.
	E-5576-R	Autocar 11CD48R Budd 3204501 Budd 49416 Trailmobile 50-34C-13 Navistar 698167R1 NWRA X-1416				

DISC WHEEL NUTS

FLANGED CAP NUTS

	EUCLID NO.	REPLACES	THREAD	HEX	HIGH	APPLICATION & GENERAL INFORMATION
	E-10234	Alcoa 389927	9/16"-18	1-1/16"	1-31/32"	2 piece flanged nut.
	E-5892	World Truck 1338003 Trailmobile 38-5892 GMC 3988631 Dana/Spicer 51-1029 Dorman 611-054	9/16"-18	7/8"	5/8"	1 piece flanged nut.
	E-9022-R	World Truck 133-9005R CHRYSLER 3637720 Navistar 437858C1 Budd 95188 Meritor R009022R NWRA X1837	5/8"-18	1-1/8"	1-1/16"	Dodge and Navistar. 2 piece flanged nut.
	E-5734	World Truck 1338002 Trailmobile 21-W182 Std. Forge 303119 GMC 3771410 Trailmobile 38-5734 Gunite 45681 Dana/Spicer 511030 Dorman 611-043 Budd 81269 Gunite K-45681 Firestone NT-30 NWRA X-1110	11/16"-16	1-1/8"	1-1/16"	Use E-5683 Stud on Rear and E-5682 Stud on Front. 1 piece flanged nut.
	E-5704	Budd 84608 Ford C3TZ1120A NWRA X-1342	3/4"-16	1-1/8"	1-1/16"	1 piece flanged nut.
	E-9021		7/8"-14	1-5/16"	7/8"	General Motors Bus. 2 piece flanged nut.
	E-10235	GMC 15642921 Webb 179920 Volvo White GMC 947971-8 Ford E6HZ1120B Ford F0HZ1012A NWRA X-2081	M20x1.5	30mm	1-1/16" 27mm	Teflon Coated. 2 piece flanged nut.
	E-5991	Navistar 1610751C1 Webb 179955 Trailmobile 50-34C-19 Motor Wheel 88881 Fruehauf MWC-X02143 NWRA X-2143	M22x1.5	1-1/2"	1-3/8"	For Motor Wheel WHD-8 (8 Stud) Hub Piloted Wheel System. 2 piece flanged nut.

For additional: Parts Information
Cross Reference
visit our online catalog at: www.XpresswayPlus.com

DISC WHEEL NUTS

FLANGED CAP NUTS

	EUCLID NO.	REPLACES	THREAD	HEX	HIGH	APPLICATION & GENERAL INFORMATION
	E-6000A	Erie 5326RH	M22x1.5	33mm	1-7/32" 31mm	Teflon Coated For Budd Uni-Mount-10 (10 Stud) Hub Piloted Wheel. 2 piece flanged nut.
E-9020	World Truck 133-9008 Navistar 1649492C1 GMC 2071619 Alcoa 39691 Alcoa 39949 Meritor A1227Z1404 Ford E6HZ1120A NWRA X2159	M22x1.5	33mm	1-1/32" 26mm	Alcoa Hub Piloted Wheels. 2 piece flanged nut.	



4

CONE LOCK NUTS (2 Piece Flanged Nut)

	EUCLID NO.	REPLACES	THREAD	HEX	HIGH	APPLICATION & GENERAL INFORMATION
	E-5708	Motor Wheel 06605 Motor Wheel 08434 GMC 2019459 NWRA X-1164	3/4"-16	1-3/16"	1-1/8"	Motor Wheel Cone Lock Nut.
E-5710	Motor Wheel 07652A Meritor 1199B2160 NWRA X-1687	7/8"-14	1-1/2"	15/16"		
E-5711	Motor Wheel 07669 Meritor 1199R616 NWRA X-1818 NWRA X1870	7/8"-14	1-1/2"	1-3/8"		

WHEEL NUTS

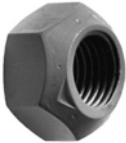
BACK NUTS



	EUCLID NO.	REPLACES	THREAD	HEX	HIGH	APPLICATION & GENERAL INFORMATION
	GRADE C	E-4961A	Dana/Spicer 341551 Budd 41073-7 Budd 47693-7 Webb 75716 Motor Wheel 82700 Fruehauf MWC-X01068 Meritor N1121 Meritor NL1121 NWRA X-1068	3/4"-16	1-1/16"	2-1/32"
	E-1835	Mack 21AX480 GMC 2236581 Freightliner 23-09598-14 Freightliner 2309598014 Hendrickson 29248 Navistar 349510C1 Budd 47693-8 Hendrickson 4842 Fruehauf FSP-004-02-013	7/8"-14	1-1/4"	49/64"	Heat Treated

WHEEL NUTS

BACK NUTS

 GRADE C	EUCLID NO.	REPLACES	THREAD	HEX	HIGH	APPLICATION & GENERAL INFORMATION
	E-1828	Hendrickson 08017000 Freightliner 23-9901-216 GMC 2320989 Ford 3538353 Navistar 422821R1 Budd 44672-9 Volvo White GMC 828325 Fruehauf MNW-934005-02D Fruehauf MNW-934005-02S NWRA X-1445	1"-14	1-1/2"	7/8"	Heat Treated

FLAT WHEEL NUTS

  	EUCLID NO.	REPLACES	THREAD	HEX	HIGH	APPLICATION & GENERAL INFORMATION
	E-5032	Trailmobile 22-T-1704 Motor Wheel 86897 Fruehauf MRM-0T1704 Fruehauf MRM-T1704D Meritor N18 Meritor N181 NWRA X-1122	1/2"-20	3/4"	7/16"	Plain. Grade 5
E-5007	GMC 3726212 NWRA X-1124	1/2"-20	7/8"	1/2"	Slotted	
E-5008	GMC 373912 NWRA X-1429	5/8"-18	15/16"	23/32"	Plain. Grade 8	

SPOKE WHEEL RIM NUTS

	EUCLID NO.	GRADE	DAYTON	ERIE	GUNITE	WEBB	NWRA	THREAD	HEX	APPLICATION & GENERAL INFORMATION
	E-4962	Grade 5	08-005149	5270	WP2	74611	N-26	5/8"-11	1-1/16"	Flat face 2 sides.
	E-4963	Grade 5	08-005716	5260	WP148	74710	N-40	3/4"-10	1-1/4"	
	E-7775	Grade 8	08-005716	5260	WP148	74710	N-40	3/4"-10	1-1/4"	



an **ArvinMeritor™** brand

WHEEL STUDS

ROUND COLLAR SHOULDER STUDS - Stud Body Diameter .781

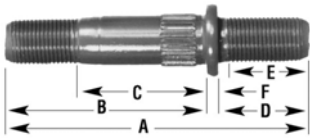
GRADE 8  3/4"-16 THDS. BOTH ENDS	EUCLID NO.	REPLACES	A	B	C	D	E	F	
	E-11722-L	Meritor 09001828		4-11/32"	3"	1-25/32"	1-1/4"	1-3/32"	3/32"
	E-11722-R	Meritor 09001827							
	E-11723-L	Meritor 09002083		4-7/16"	2-57/64"	1-7/16"	1-29/64"	1-1/4"	
	E-11723-R	Meritor 09002082							
	E-11721-L	Meritor 09001401		4-33/64"	3-1/16"	2-25/32"	1-11/32"	1-1/8"	7/64"
	E-11721-R	Meritor 09001400							

4

ROUND COLLAR SHOULDER STUDS - Stud Body Diameter .784

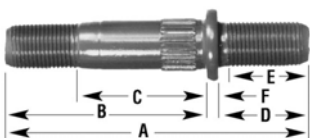
GRADE 8  3/4"-16 THDS. BOTH ENDS	EUCLID NO.	REPLACES	A	B	C	D	E	F	
	E-5713-L	Budd 75932 NWRA X-1607		3-13/32"	2-1/16"	7/8"	1-1/4"	1-1/16"	3/32"
	E-5713-R	Meritor 20X606 Budd 75931 NWRA X-1606							
	E-5714-L	Meritor 20X603 Meritor 20X605 Budd 82582 NWRA X-1609		3-5/8"	2-9/32"	1-1/16"		1-1/8"	
	E-5714-R	Meritor 20X604 Budd 82581 NWRA X-1608							
	E-5715-L	Budd 63386 NWRA X-1613		4-1/32"	2-1/2"	1-9/32"	1-11/32"	1-5/32"	
	E-5715-R	Budd 63385 NWRA X-1612							

S.O.S.

Special Order Service

Can't find it?

Trouble sourcing products?

Need assistance?

Let Euclid's Special Order Service (S.O.S.) help you find your parts.

Euclid's position as the market leader provides you access to a comprehensive array of truck parts products from the industry's leading manufacturers. Through Euclid, these entire product lines are available to you just by placing a phone call to Euclid's S.O.S. Department at 866-238-2543 (option 2) in the U.S. or 800-387-3889 in Canada.

WHEEL STUDS

ROUND COLLAR SHOULDER STUDS - Stud Body Diameter .784

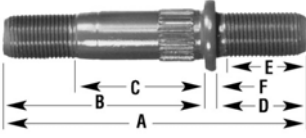
<p>GRADE 8</p>  <p>3/4"-16 THDS. BOTH ENDS</p>	EUCLID NO.	REPLACES	A	B	C	D	E	F
	E-5716-L	Budd 80698 Fruehauf MWC-X01615 NWRA X-1615	4-11/32"	3"	1-15/16"	1-1/4"	1-1/16"	3/32"
	E-5716-R	Budd 80697 Fruehauf MWC-X01614 NWRA X-1614						
	E-5717-L	Budd 69206 NWRA X-2108	4-17/32"			1-11/32"	1-5/32"	
	E-5717-R	Budd 69205 NWRA X-2107						
	E-5589-L	Webb 101301 Meritor 20X601 Fruehauf 582885 Budd 83813 Fruehauf ACD7629PK2 Fruehauf MWC-X01617 Paccar SNNK017L NWRA X-1617	4-5/8"	3-9/32"	2"	1-1/4"	1-1/8"	
	E-5589-R	Webb 101302 Meritor 20X602 Fruehauf 582884 Budd 83812 Fruehauf ACD7629PK1 Fruehauf MWC-X01616 Paccar SNNK017R NWRA X-1616						
	E-8948-L	Budd 101322	4-29/32"	3-17/32"	2-5/32"		31/32"	
	E-8948-R	Budd 101321						

CLIPPED COLLAR SHOULDER STUDS - Stud Body Diameter .784

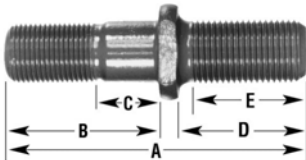
<p>GRADE 8</p>  <p>3/4"-16 THDS. BOTH ENDS</p>	EUCLID NO.	REPLACES	A	B	C	D	E
	E-5558-L	Budd 12248 Meritor 20X1041 Fruehauf 534771 NWRA X-1555	3-1/8"	1-19/32"	5/8"	1-11/32"	1-5/32"
	E-5558-R	Budd 12247 Meritor 20X1040 Dana/Spicer 5011101R Fruehauf 534770 NWRA X-1554					
	E-5556-L	Budd 13097 Meritor 20X55 Trailmobile 50-33A-10 Gunitite K25261 Fruehauf MXC-X01559 NWRA X-1559	3-19/32"	2-1/16"	7/8"		
	E-5556-R	Budd 13096 Meritor 20X54 Trailmobile 50-33A-9 Gunitite K25260 Fruehauf MWC-X01558 NWRA X-1558					

WHEEL STUDS

CLIPPED COLLAR SHOULDER STUDS - Stud Body Diameter .784

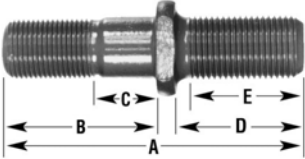
	EUCLID NO.	REPLACES	A	B	C	D	E
<p>GRADE 8</p>  <p>$\frac{3}{4}$"-16 THDS. BOTH ENDS</p>	E-5559-L	Budd 13989 Meritor 20X37 Budd 3025202 Fruehauf 534783 Navistar 698795R1 Fruehauf MWC-X01563 NWRA X-1563	3-23/32"	2-3/16"	1-1/16"	1-11/32"	1-5/32"
	E-5559-R	Budd 13988 Meritor 20X38 Budd 3025201 Fruehauf 534782 Navistar 698794R1 Fruehauf MWC-X01562 NWRA X-1562					
	E-5561-L	Budd 13991 Webb 139913 Meritor 20X53 Fruehauf 534773 NWRA X-1569	3-31/32"	2-7/16"	1-5/32"		
	E-5561-R	Budd 13990 Webb 139902 Meritor 20X52 Meritor 20X53 Fruehauf 534772 NWRA X-1568					
	E-5560-L	Budd 19005 Fruehauf 509360 Fruehauf MWC-X01573 NWRA X-1573	4-1/32"	2-1/2"	1-9/32"		1-5/32"
	E-5560-R	Budd 19004 Fruehauf 508865 Fruehauf MWC-X01572 NWRA X-1572					
	E-5551-L	Budd 17124 Mack 18AX424 Meritor 20X59 Navistar 44669H, 48796H Fruehauf 502786 NWRA X-1575	4-7/32"	2-11/16"	1-7/16"		
	E-5551-R	Budd 17123 Mack 18AX423 Meritor 20X58 Navistar 44668H, 48797H Fruehauf 502787 NWRA X-1574					
	E-5585-L	Meritor 20X71 Budd 22006 Trailmobile 50-33A-38 NWRA X-1579	4-11/32"	2-13/16"	1-25/32"		
	E-5585-R	Meritor 20X70 Budd 22005 Trailmobile 50-33A-37 NWRA X-1578					

WHEEL STUDS

CLIPPED COLLAR SHOULDER STUDS - Stud Body Diameter .784

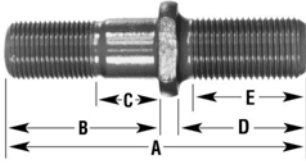
GRADE 8  3/4"-16 THDS. BOTH ENDS	EUCLID NO.	REPLACES	A	B	C	D	E
	E-5553-L	Budd 16272 Meritor 20X67 Trailmobile 50-33A-16 Fruehauf 535921 Navistar 59864H Fruehauf MWC-X01581 NWRA X-1581	4-17/32"	3"	1-29/64"	1-11/32"	1-5/32"
	E-5553-R	Budd 16271 Meritor 20X66 Trailmobile 50-33A-15 Fruehauf 535920 Navistar 59863H Fruehauf MWC-X01580 NWRA X-1580					
	E-10200-L	Conmet 100330 Freightliner 11-9714-006					
	E-10200-R	Conmet 100329 Freightliner 11-9714-007					
	E-6023-L	Conmet 100118 Meritor 20X143 Budd 21943 NWRA X-1587	4-27/32"	3-5/16"	1-21/32"		
	E-6023-R	Conmet 100117 Meritor 20X142 NWRA X-1586					
	E-5557-L	Budd 16004 Mack 18AX990 Meritor 20X41 Fruehauf 534785 Navistar 698797R1 NWRA X-1589	5-1/32"	3-1/2"	2-15/32"		
	E-5557-R	Budd 16003 Mack 18AX989 Meritor 20X42 Fruehauf 534784 Navistar 698796R1 NWRA X-1588					
	E-6024-L	Conmet 100257	5-1/4"	3-5/16"	1-21/32"	1-3/4"	
E-6024-R	Conmet 100256						

CLIPPED COLLAR SHOULDER STUDS - Stud Body Diameter .784 EXTRA LONG CAP NUT END

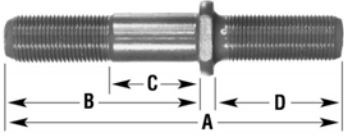
GRADE 8  3/4"-16 THDS. BOTH ENDS	EUCLID NO.	REPLACES	A	B	C	D	CAUTION
	E-5932-L	Freightliner 11-9714-2 Webb 195694 NWRA X-1577	4-1/4"	2-3/8"	1-1/16"	1-5/8"	Caution: Do not use with Steel wheel. Cap nut will bottom out before tightening against wheel.
	E-5932-R	Freightliner 11-9714-3 Webb 195693 NWRA X-1576					
	E-5931-L	Freightliner 11-9714-11 NWRA X-2054	4-1/2"		1-1/32"	1-15/16"	
	E-5931-R	Freightliner 11-9714-12 NWRA X-2053					

WHEEL STUDS

CLIPPED COLLAR SHOULDER STUDS - Stud Body Diameter .784
EXTRA LONG CAP NUT END

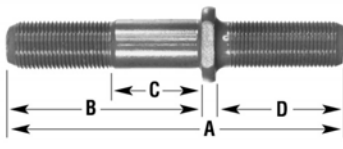
<p>GRADE 8</p>  <p>3/4"-16 THDS. BOTH ENDS</p>	EUCLID NO.	REPLACES	A	B	C	D	<p>CAUTION</p> <p>Caution: Do not use with Steel wheel. Cap nut will bottom out before tightening against wheel.</p>
	E-5989-L	Conmet 100524 Freightliner 11-9714-5 Webb 18301 Webb 183101	4-29/32"	3-3/8"	1-55/64"	1-23/64"	
	E-5989-R	Conmet 100525 Freightliner 11-9714-4 Webb 183102					
	E-5933-L	Freightliner 11-9714-0 Budd 95692 NWRA X-1593 NWRA X-1583	5-1/8"	2-3/4"	1-11/16"	2-1/4"	
	E-5933-R	Freightliner 11-9714-1 Budd 95691 NWRA X-1592					
	E-5929-L	Freightliner 11-9714-15 NWRA X-2056	5-3/16"	3"	1-5/16"	2"	
	E-5929-R	Conmet 100524/5 Freightliner 11-9714-16 NWRA X-2055					
	E-5930-L	Freightliner 11-9714-13 NWRA X-2058	5-9/16"	3-3/8"	1-3/4"		
E-5930-R	Conmet 100526 Freightliner 11-9714-14 NWRA X-2057						

4

BUS AND HEAVY-DUTY STUDS

CLIPPED COLLAR SHOULDER STUDS - Stud Body Diameter 1.012
For Heavy-Duty "Off Highway" Application

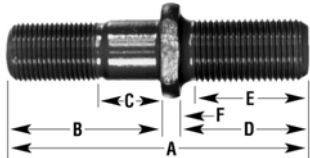
<p>GRADE 8</p>  <p>1"-14 THD. HUB END 1 5/16"-12 THD WHEEL END</p>	EUCLID NO.	REPLACES	A	B	C	D	E	F
	E-5876-L	Budd 63342 Meritor R005876L NWRA X-1637	Budd 63341 Meritor R005876R NWRA X-1636	5-5/8"	3-1/2"	1-7/8"	1-7/8"	1-9/16"
E-5876-R								

DOUBLED-ENDED ROUND COLLAR STUDS - Stud Body Diameter .973

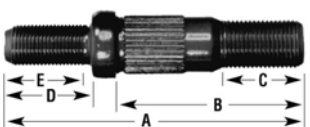
<p>GRADE 8</p>  <p>3/4"-16 THD. WHEEL END 7/8"-14 THD. HUB END</p>	EUCLID NO.	REPLACES	A	B	C	D	E	
	E-5920-L	Meritor 20X1227 NWRA X-1942	Meritor 20X1228 NWRA X-1941	4"	2-3/32"	1-1/4"	1-7/16"	1-3/16"
	E-5920-R							
	E-5918-L	Meritor 20X1233 NWRA X-1946	Meritor 20X1234 NWRA X-1945	4-15/16"	3-3/32"	1-9/32"		
E-5918-R								

BUS AND HEAVY-DUTY STUDS

DOUBLED-ENDED ROUND COLLAR STUDS - Stud Body Diameter .973

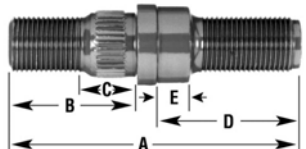
GRADE 8  7/8"-14 THD. BOTH ENDS	EUCLID NO.	REPLACES	A	B	C	D	E
	E-9006	Meritor 20X2128	4-1/4"	1-7/8"	15/16"	2-1/16"	7/16"
	E-9007	Meritor 20X2144	5-5/8"			3-7/16"	1-1/4"

DOUBLE-ENDED STUDS WITH FLATS - Stud Body Diameter .784 - For Steel Wheels

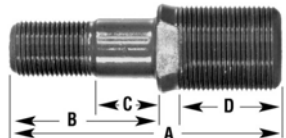
GRADE 8  1 1/8"-16 THD. WHEEL END 3/4"-16 THD. HUB END	EUCLID NO.	REPLACES	A	B	C	D
	E-3723-L	Meritor 20X90 Budd 32310 NWRA X-1513	3-3/16"	1-19/32"	5/8"	1-13/32"
	E-3723-R	Meritor 20X89 Budd 32309 NWRA X-1512				
	E-3728-L	Budd 35090 NWRA X-1525	4-11/32"	2-3/4"	1-13/16"	
	E-3728-R	Budd 35089 NWRA X-1524				

DOUBLE-ENDED STUDS WITH FLATS - Stud Body Diameter .784 - For Aluminum Wheels

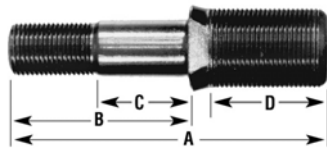
GRADE 8  1 1/8"-16 THD. WHEEL END 3/4"-16 THD. HUB END	EUCLID NO.	REPLACES	A	B	C	D
	E-5935-L	Budd 95712 NWRA X-1517	3-3/4"	1-7/8"	23/32"	1-11/16"
	E-5935-R	Budd 95711 NWRA X-1516				
	E-5936-L	Budd 31704 Budd 95708 NWRA X-1521	3-15/16"	2-1/16"	31/32"	
	E-5936-R	Budd 31703 Budd 95707 NWRA X-1520				
	E-5937-L	Budd 90218 NWRA X-1523	4-1/4"	2-7/16"	1-7/32"	1-5/8"
	E-5937-R	Budd 90217 NWRA X-1522				
	E-5990-L	Freightliner 10-9607-001	4-9/16"	2-3/4"	1-37/64"	1-1/2"
	E-5990-R	Freightliner 10-9607-000				

Stud Body Diameter .784

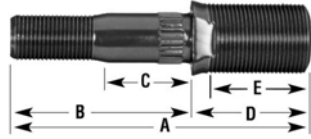
GRADE 8  1 1/8"-16 THD. WHEEL END 3/4"-16 THD. HUB END	EUCLID NO.	REPLACES	A	B	C	D	E
	E-8951-L	Conmet 100343	4-9/16"	2-3/4"	1-17/32"	1-13/16"	1-1/4"
E-8951-R	Conmet 100344						

BUS AND HEAVY-DUTY STUDS

Stud Body Diameter .973

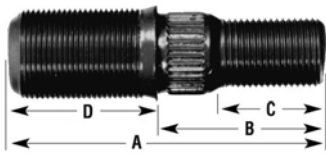
GRADE 8  1 1/8"-16 THD. WHEEL END 7/8"-14 THD. HUB END	EUCLID NO.	REPLACES	A	B	C	D
	E-5922-L	Meritor 20X1241 Meritor 20X1867 Navistar 549807C1 NWRA X-1948	4" 2" 1-3/16" 1-3/4"	E-5922-R	Meritor 20X1242 Meritor 20X1868 NWRA X-1947	

DOUBLE-ENDED STUDS WITHOUT FLATS - Stud Body Diameter 1.220

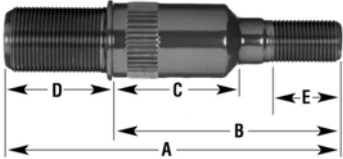
GRADE 8  1 1/8"-16 THD. WHEEL END 3/4"-16 THD. HUB END	EUCLID NO.	REPLACES	A	B	C	D	E
	E-8976-L	Meritor 20X1761 Meritor 20X2233 Gunitite W1060L	5-5/16" 3-5/8" 2-3/32" 1-11/16" 1"	E-8976-R	Meritor 20X1760 Meritor 20X2234 Gunitite W1060R		

WHEEL STUDS

WEDGE HEAD TYPE STUDS - Stud Body Diameter .788

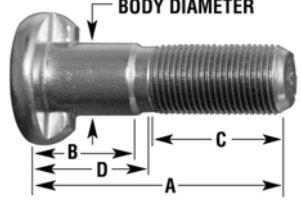
GRADE 8  3/4"-16 THD.	EUCLID NO.	REPLACES	A	B	C	D
	E-9005-L	Meritor 20X2089	2-5/8" 1" 1-1/4" 1-1/4"	E-9005-R	Meritor 20X2088	
	E-9004-L	Meritor 20X1979			3-7/64" 1-13/32" 1-23/64" 1-3/4"	E-9004-R

WEDGE HEAD TYPE STUDS - Stud Body Diameter .792 - For Aluminum Hubs

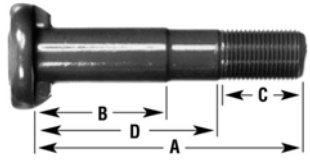
GRADE 8  3/4"-16 THD.	EUCLID NO.	REPLACES	A	B	C	D
	E-5924-L	Meritor 20X1334 Meritor 20X1463 Meritor 20X1978 Mack 8235-20X1463 NWRA X-1914	3-13/32" 1-7/16" 1-5/8" 2-1/4"	E-5924-R	Meritor 20X1335 Meritor 20X1464 Meritor 20X1977 Mack 8235-20X1464 NWRA X-1913	
	E-5916-L	Meritor 20X1311 Meritor 20X1459 NWRA X-1916			3-35/64" 1-13/16" 1-1/16" 2-31/64"	E-5916-R
	E-9002-L	Meritor 20X1471	3-3/4" 1-1/2" 1-3/4" 1-3/4"	E-9002-R		

WHEEL STUDS

WEDGE HEAD TYPE STUDS - Stud Body Diameter .792 - For Aluminum Hubs

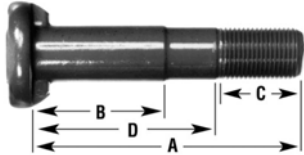
GRADE 8  3/4"-16 THD.	EUCLID NO.	REPLACES	A	B	C	D
	E-5923-L	Meritor 20X1309 Meritor 20X1457 Navistar 469025C1 NWRA X-1918	3-51/64"	1-13/16"	1-1/8"	2-5/8"
	E-5923-R	Meritor 20X1310 Meritor 20X1458 Navistar 469026C1 NWRA X-1917				
	E-9000-L	Meritor 20X1307 Navistar 549809C1 NWRA X2044	3-31/32"	1-5/16"	2"	1-3/4"
	E-9000-R	Meritor 20X1308 Navistar 549810C1 NWRA X2043				

FRONT WHEEL STUDS - Stud Body Diameter 1.216

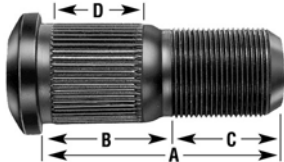
GRADE 8  1 1/8"-16 THD.	EUCLID NO.	REPLACES	A	B	C	D
	E-5897-L	Meritor 20X1563 Meritor 20X1564 Meritor 20X378 Budd 83819 Navistar 894786R1 NWRA X-1724	2-5/8"	7/8"	1-3/4"	7/16"
	E-5897-R	Meritor 20X1563 Meritor 20X1564 Meritor 20X377 Budd 83818 Navistar 894787R1 NWRA X-1723				
	E-5986-L	Webb 188109 Navistar 472008R1 Motor Wheel 89086 NWRA X-1984	2-61/64"	1-3/4"	1-61/64"	9/16"
	E-5986-R	Webb 188108 Navistar 472007R1 Motor Wheel 89085 NWRA X-1983				
	E-11697-L	Meritor 09001926	2-31/32"	1-3/16"	1-25/32"	29/64"
	E-11697-R	Meritor 09001925				
	E-11699-L	Meritor 09002000	3-1/8"		2-1/16"	
	E-11699-R	Meritor 09001999				
	E-11695-L	Meritor 09001218	3-3/16"	1-5/16"	1-19/32"	3/4"
	E-11695-R	Meritor 09001217				
	E-5898-L	Meritor 20X589 Navistar 438061R1 Navistar 581674C1 Gunite W1148L NWRA X-1932	3-3/16"	1-3/8"	1-13/16"	1"
	E-5898-R	Meritor 20X588 Navistar 438062R1 Gunite W1148R NWRA X-1931				
	E-8996-L	Motor Wheel 88292 NWRA X1992	3-1/4"	3/4"	2-1/4"	5/8"
	E-8996-R	Motor Wheel 88291 NWRA X1991				

WHEEL STUDS

FRONT WHEEL STUDS - Stud Body Diameter 1.216

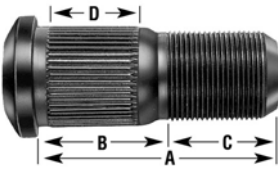
	EUCLID NO.	REPLACES	A	B	C	D
	GRADE 8  <p style="text-align: center;">1 1/8"-16 THD.</p>	E-11696-L	Meritor 09001669	3-13/32"	1-5/16"	1-13/16"
E-11696-R		Meritor 09001668				
E-9001-L		Meritor 20X1357 Meritor 20X1477 Meritor 20X1478 Dana/Spicer 501093L Dana/Spicer 501093R NWRA X2038	3-15/32"	7/8"	1-29/64"	7/16"
E-9001-R		Meritor 20X1356 Meritor 20X1477 Meritor 20X1478 Dana/Spicer 501093L Dana/Spicer 501093R NWRA X2037				
E-8972-L		GMC 15552787 Navistar 292963C1 Navistar 593096C1 Ford E4HZ1108E Ford E8HZ1107B Gunitite W1118L Gunitite W720L Gunitite W788L Gunitite W988L	3-1/2"	1-3/16"	2-1/32"	3/4"
E-8972-R		GMC 15552788 Navistar 292964C1 Navistar 593097C1 Ford E4HZ1107E Ford E8HZ1107A Gunitite W1118R Gunitite W720R Gunitite W788R Gunitite W988R				
E-8995-L		Motor Wheel 87143 NWRA X1767	3-9/16"	1-7/16"	1-3/4"	1"
E-8995-R		Motor Wheel 87142 NWRA X1766				
E-6033-L		Budd 100018 Webb 100181 Eaton 100858006	3-5/8"	1-3/4"	1-7/8"	1/2"
E-6033-R		Budd 100017 Webb 100170 Eaton 100858010				

FRONT WHEEL STUDS - Stud Body Diameter 1.220

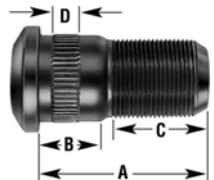
	EUCLID NO.	REPLACES	A	B	C	D
	GRADE 8  <p style="text-align: center;">1 1/8"-16 THD.</p>	E-5748-L	Navistar 110001R1 Meritor 20X369 Budd 82574 NWRA X-1719	2-13/32"	7/8"	1-7/32"
E-5748-R		Navistar 110002R1 Meritor 20X370 Budd 82573 NWRA X-1718				

WHEEL STUDS

FRONT WHEEL STUDS - Stud Body Diameter 1.220

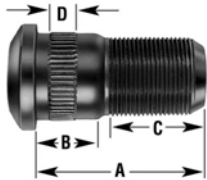
	EUCLID NO.	REPLACES	A	B	C	D
<p>GRADE 8</p>  <p>1 1/8"-16 THD.</p>	E-5749-L	Meritor 20X371 Meritor 20X379 Navistar 224957R1 Budd 82576 Paccar PAC5L NWRA X-1726	2-13/16"	7/8"	1-7/32"	7/16"
	E-5749-R	Meritor 20X372 Meritor 20X380 Navistar 224958R1 Budd 82575 Paccar PAC5R NWRA X-1725				
	E-5750-L	Meritor 20X585 Navistar 447556R1 Budd 83854 NWRA X-1728	3"	1-3/8"	1-5/8"	1"
	E-5750-R	Meritor 20X584 Navistar 447557R1 Budd 82853 NWRA X-1727				
	E-5899-L	Meritor 20X747 NWRA X-1928	3-1/8"	1-19/32"	1-17/32"	3/8"
	E-5899-R	Meritor 20X746 Navistar 753613C1 NWRA X-1927				
	E-8966-L	GMC 15543998 Mack 18AX1159 GMC 2075453 Meritor 20X1755 Ford D5HZ1108A Gunite W1104L, W932L Gunite W826L, W890L	3-9/16"	1-9/16"	1-23/32"	1/2"
	E-8966-R	GMC 15514399 Mack 18AX1158 GMC 2075454 Meritor 20X1754 Ford D5HZ1107A Gunite W1104R, W932R Gunite W826R, W890R				
	E-5868-L	Webb 133609 Navistar 469610C1 Navistar 469610C7 Navistar 773434C1 Budd 85382, 99617 Eaton F18479 NWRA X-1732	3-5/8"	1-13/16"	1-13/16"	3/4"
	E-5868-R	Webb 133610 Navistar 469609C1 Navistar 469609C7 Navistar 773433C1 Budd 85381, 99616 Eaton F184710 NWRA X-1731				

WHEEL STUDS

FRONT WHEEL STUDS - Stud Body Diameter 1.220

GRADE 8  1 1/8"-16 THD.	EUCLID NO.	REPLACES	A	B	C	D
	E-8985-L	Gunite W1203L	3-13/16"	1-3/16"	2-1/2"	3/4"
	E-8985-R	Gunite W1203R				
	E-8990-L	Kenworth K233C372L NWRA X2172	4"	1-5/16"	1-13/16"	
	E-8990-R	Kenworth K233C372L NWRA X2171				

FRONT WHEEL STUDS - Stud Body Diameter 1.220 - For Aluminum Disc Wheels

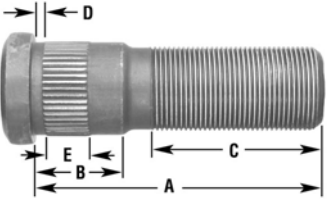
GRADE 8  1 1/8"-16 THD.	EUCLID NO.	REPLACES	A	B	C	D	E
	E-10224-L	Meritor 20X469 Meritor 20X583 NWRA X2034	2-29/32"	1-3/8"	1-7/32"	1/4"	1"
	E-10224-R	Meritor 20X460 Meritor 20X582 NWRA X2033					
	E-5982-L	Peterbilt 02-00771 Kenworth K233B359L NWRA X-2134	3-3/4"	1-7/32"	2-1/4"	1/8"	9/16"
	E-5982-R	Peterbilt 02-00772 Kenworth K233B359R NWRA X-2133					
	E-10249-L	Meritor 20X1475 NWRA X-2112	3-25/32"	1-3/8"	2-1/2"	5/8"	1/2"
	E-10249-R	Meritor 20X1476 NWRA X-2111					
	E-5985-L	Meritor 20X587 NWRA X-2114	3-25/32"	1-7/16"	7/32"	1"	
	E-5985-R	Meritor 20X586 NWRA X-2113					

FRONT WHEEL STUDS - Stud Body Diameter 1.220 - For Aluminum Disc Wheels

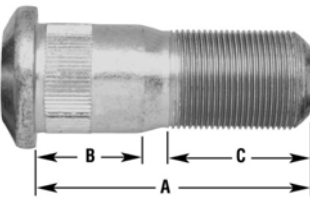
GRADE 8  1 1/8"-16 THD.	EUCLID NO.	REPLACES	A	B	C
	E-10227-L	Conmet 103189	3-3/32"	1-5/32"	1-15/32"
	E-10227-R	Conmet 103190			
	E-10226-L	Conmet 102084	3-13/32"	1-17/32"	
	E-10226-R	Conmet 102085			
	E-10228-L	Conmet 103191	3-9/16"	1-5/32"	1-15/16"
	E-10228-R	Conmet 103192			
	E-10225-L	Conmet 101873	3-7/8"	1-17/32"	1-29/32"
	E-10225-R	Conmet 101874			

WHEEL STUDS

SERRATED WHEEL STUDS - Stud Body Diameter .630

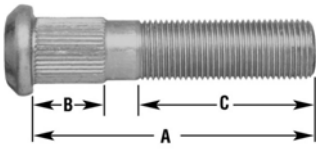
GRADE 8  5/8"-18 THD.	EUCLID NO.	REPLACES	A	B	C
	E-10229	GMC 2202033 GMC 3694508 Gunitite K-34460	2-15/16"	3/4"	1-1/4"
E-10230	GMC 3697043 Gunitite K-43939	3-3/16"	1"	1-1/2"	

SERRATED WHEEL STUDS - Stud Body Diameter .784

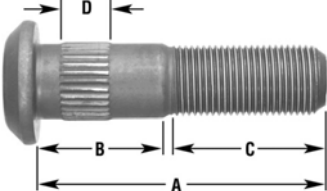
GRADE 8  3/4"-16 THD.	EUCLID NO.	REPLACES	A	B	C	D
	E-10202-L	GMC 15514381 Gunitite W-1091L	2-1/2"	3/4"	1-1/2"	1/2"
E-10202-R	GMC 15514382 Gunitite W-1091R					
E-10203-L	Ford C8TX1107B Ford C8TZ1107H Gunitite WP-466L	2-5/8"	1-11/32"	1"		
E-10203-R	Ford C8TZ1107A Ford C8TZ1107J Gunitite WP-466R					
E-8983-L	Gunitite W1170L	2-11/16"	31/32"	1-13/32"		
E-8983-R	Gunitite W1170R					
E-8969-L	GMC 15580833 Gunitite W-112 Gunitite W981L	2-15/16"	1-5/16"			
E-8969-R	GMC 15580830 Gunitite W-1121R Gunitite W981R					
E-10206-L	Navistar 1659065C1 Gunitite W-1064L	3"	1-21/32"	1-1/4"		
E-10206-R	Navistar 1659066C1 Gunitite W-1064R					
E-8982-L	World Truck 168-1008L Gunitite W1166L	3-1/8"	1-11/32"	1-19/32"		
E-8982-R	World Truck 168-1008R Gunitite W1166R					
E-10209-L	Conmet 102277 Motor Wheel 91156	3-5/32"	1-7/16"	1-1/2"		
E-10209-R	Conmet 102278 Motor Wheel 91155					
E-8968-L	World Truck 168-1009L Gunitite W980L	3-3/16"	1-13/32"	1-5/8"		
E-8968-R	World Truck 168-1009R Gunitite W980R					
E-10201-L	GMC 2095341 Navistar 584071C1 Gunitite W-1006L	3-1/4"	1-3/4"	1-3/8"		
E-10201-R	GMC 2095342 Navistar 584072C1 Gunitite W-1006R					
E-8979-L	Navistar 597991C1 Gunitite W1133L Gunitite W992L	3-11/32"	1-9/32"	1-27/32"		
E-8979-R	Navistar 597992C1 Gunitite W1133R Gunitite W992R					

WHEEL STUDS

SERRATED WHEEL STUDS - Stud Body Diameter .784

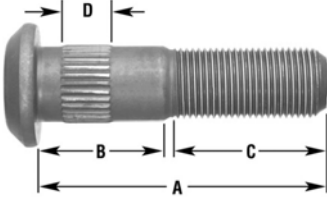
GRADE 8  3/4"-16 THD.	EUCLID NO.	REPLACES	A	B	C	D
	E-10208-L	Conmet 102279	3-13/32"	1-7/16"	1-5/8"	1/2"
	E-10208-R	Conmet 102280				
	E-10210-L	Conmet 102281	3-25/32"	2"		
	E-10210-R	Conmet 102282				

4

SERRATED WHEEL STUDS - Stud Body Diameter .974

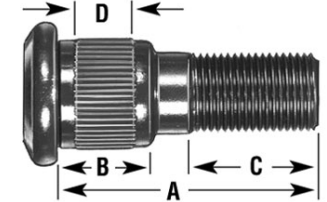
GRADE 8  3/4"-16 THD.	EUCLID NO.	REPLACES	A	B	C	D
	E-5718-L	Meritor 20X209 Navistar 212254R1 Budd 63626-2 Ford 7EQ1119 NWRA X-1834	2-3/8"	3/4"	1-5/32"	1/2"
	E-5718-R	Meritor 20X208 Navistar 212255R1 Budd 63625-2 Ford 7EQ1118 NWRA X-1833				
	E-5719-L	Meritor 20X211 Fruehauf 298484 Budd 63626-3 NWRA X-1392	2-9/16"	1-3/8"		
	E-5719-R	Meritor 20X210 Fruehauf 298485 Budd 63625-3 NWRA X-1391				
	E-5900-L	Meritor 20X831 NWRA X-1906	2-23/32"	1-19/32"		
	E-5900-R	Meritor 20X832 NWRA X-1905				
	E-5987-L	GMC 717005 Motor Wheel 86798 NWRA X1763	2-29/32"	1-3/16"	1-1/4"	1"
	E-5987-R	GMC 717004 Motor Wheel 86797 NWRA X1762				
	E-5871-L	Meritor 20X481 Navistar 791042C1 Paccar K233344L Paccar PAC-4 Paccar PAC4L NWRA X-1862	3-3/32"	1-3/8"		
	E-5871-R	World Truck 1541404R Meritor 20X482 Navistar 791043C1 Paccar K233344R Paccar PAC-3 Paccar PAC3R NWRA X-1861				

WHEEL STUDS

SERRATED WHEEL STUDS - Stud Body Diameter .974

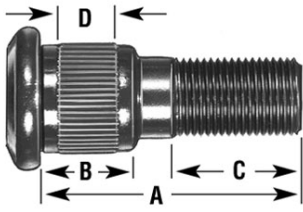
GRADE 8  3/4"-16 THD.	EUCLID NO.	REPLACES	A	B	C	D
	E-5720-L	Meritor 20X207 Navistar 277773C1 Budd 63626-1 Budd 63626E1 Navistar 89764R1 NWRA X-1394	3-5/32"	2-3/4"	1-15/32"	17/32"
	E-5720-R	Meritor 20X206 Navistar 277774C1 Budd 63625-1 Budd 63625E1 Navistar 89765R1 NWRA X-1393				
	E-6057-L	Motor Wheel 90802	3-3/16"	1-3/16"	1-5/32"	1"
	E-6057-R	Motor Wheel 90801				
	E-5896-L	Kenworth K233-287L NWRA X-1936	3-3/8"	1-3/8"	1-1/4"	
	E-5896-R	Kenworth K233-287R NWRA X-1935				

SERRATED WHEEL STUDS - Stud Body Diameter .745

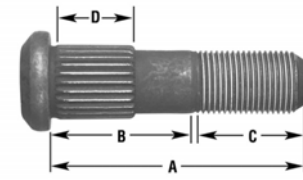
GRADE 8  3/4"-16 THD.	EUCLID NO.	REPLACES	A	B	C	D	
	E-8994-L	Motor Wheel 82018 NWRA X1746	Motor Wheel 82017 NWRA X1745	2-1/2"	1-5/32"	1-1/4"	29/32"
	E-8994-R						
	E-8992-L	Motor Wheel 82096 NWRA X1752	Motor Wheel 82095 NWRA X1751	2-31/32"	1-19/32"	1-3/16"	15/16"
	E-8992-R						
	E-8993-L	GMC 02210240 Motor Wheel 82843 NWRA X1754	GMC 02210239 Motor Wheel 82842 NWRA X1753	3-1/4"	1-7/8"	1-5/32"	1-1/8"
E-8993-R							

DRIVE AXLE STUD - Stud Body Diameter .975 - For Aluminum Disc Wheels

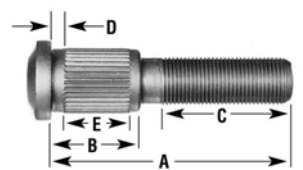
GRADE 8  3/4"-16 THD.	EUCLID NO.	REPLACES	A	B	C	D	E
	E-5983-L	Peterbilt 03-02853 NWRA X-2132	Peterbilt 03-02852 NWRA X-2131	3-3/4"	1-3/8"	2-1/4"	1/4"
E-5983-R							

WHEEL STUDS

SERRATED WHEEL STUDS

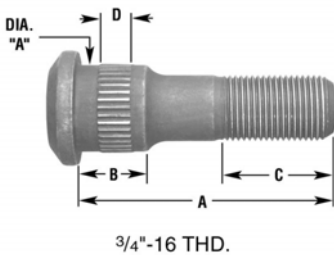
	EUCLID NO.	REPLACES	BODY DIA.	A	B	C	D
			"A"				
<p>GRADE 8</p>  <p style="text-align: center;">3/4\"-16 THD.</p>	E-8958-L	Dayton-Walthers 09-861902	.772	2-7/8"	1-1/2"	1-3/16"	1/2"
	E-8958-R	Dayton-Walthers 09-861901					
	E-8955-L	Navistar 576711C1	.778	3-3/8"	1-9/32"	1-15/16"	
	E-8955-R	Navistar 576712C1					
	E-8957-L	Ford E4HZ1108B		3-1/2"	1-25/32"	1-9/32"	
	E-8957-R	Ford E4HZ1107B					
	E-8954-L	Fruehauf MDS001327		3-27/32"	2-11/32"		
	E-8954-R	Fruehauf MDS001326					
	E-11680-L	Meritor 09869702	.780	2-3/8"	1"	1-1/16"	
	E-11680-R	Meritor 09869701					
	E-11673-L	Meritor 09001966		2-21/32"	7/8"	1-11/32"	
	E-11673-R	Meritor 09001965					
	E-11664-L	Meritor 09001540		3-1/8"	1-21/32"	1-5/16"	
	E-11664-R	Meritor 09001539					
	E-11667-L	Meritor 09001651	.782	2-3/4"	1-3/8"	1-13/64"	
	E-11667-R	Meritor 09001650					
	E-11668-L	Meritor 09001653		2-7/8"	1"	1-3/4"	
	E-11668-R	Meritor 09001652					
	E-11666-L	Meritor 09001615		2-15/16"	1-1/16"		
	E-11666-R	Meritor 09001614					
	E-9011-L	Webb 159191	.784	2-3/8"	7/8"	1-1/16"	
	E-9011-R	Webb 159190					
	E-8978-L	Meritor 20X1746 Mack 3398W883L Gunite W1073L		3-13/32"	1-29/32"	1-7/32"	
	E-8978-R	Meritor 20X1747 Mack 3398W883R Gunite W1073R					
	E-8977-L	Fruehauf MMGW1061L		3-7/8"	2-1/16"	1-11/16"	
	E-8977-R	Fruehauf MMGW1061R					
	E-11658-L	Meritor 09001255	.790	2-9/16"	1-5/64"	1-1/4"	
	E-11658-R	Meritor 09001254					
	E-11660-L	Meritor 09002048	.890	2-1/8"	11/16"		
	E-11660-R	Meritor 09002047					
	E-11681-L	Meritor 09002211		2-27/64"	1"	1-15/64"	
	E-11681-R	Meritor 09002210					
E-11682-L	Meritor 09002205		2-11/16"	1-1/8"	1-3/8"	3/8"	
E-11682-R	Meritor 09002204						
E-5911-L	Navistar 131281R1 Meritor 20X403 NWRA X-1885	.974	2-9/16"	15/16"	1-1/4"	7/16"	
E-5911-R	Navistar 131282R1 Meritor 20X402 NWRA X-1884						
E-5721-L	Meritor 20X121 Meritor 20X405 Navistar 443660C1 Budd 82579 Navistar 98726R1 NWRA X-1844		2-13/16"	1-3/16"	1-3/16"	3/8"	
E-5721-R	Meritor 20X404 Navistar 443661C1 Navistar 98727R1 NWRA X-1843						

WHEEL STUDS

SERRATED WHEEL STUDS

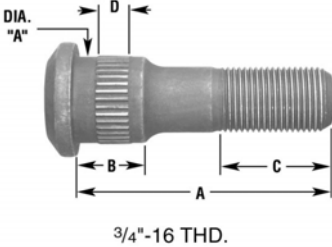
GRADE 8 	EUCLID NO.	REPLACES	BODY DIA. "A"	A	B	C	D					
		E-9010-L	Webb 101173	.974	2-27/32"	13/16"	1-1/8"	1/2"				
	E-9010-R	Webb 101172	3-1/8"		1-5/16"		7/16"					
	E-5910-L	Meritor 20X345 NWRA X-1889	3-3/16"		25/32"	1-19/32"	1/2"					
	E-5910-R	Meritor 20X344 NWRA X-1888	3-11/32"			25/32"						
	E-9524-L	Webb 101175	1-27/32"		1-1/16"							
	E-9524-R	Webb 101174										
	E-9525-L	Webb 101179	4"		2-7/16"	1-3/16"	1-5/8"					
	E-9525-R	Webb 101178										
	E-5909-L	Meritor 20X853 Navistar 351138C1 NWRA X-1894	.974"		2-19/32"	13/16"	1-1/8"	1/4"				
	E-5909-R	Meritor 20X852 Navistar 351139C1 NWRA X-1893										
	E-5722-L	Meritor 20X478 Budd 83852 NWRA X-1379										
	E-5722-R	Meritor 20X1283 Meritor 20X477 Budd 83851 NWRA X-1378										
	E-9523-L	Webb 101171										
	E-9523-R	Webb 101170										
	E-11669-L	Meritor 09001764		1.00					3-27/32"	1-13/64"	1-5/16"	9/16"
	E-11669-R	Meritor 09001763										

WHEEL STUDS

SERRATED WHEEL STUDS - Stud Body Diameter .784

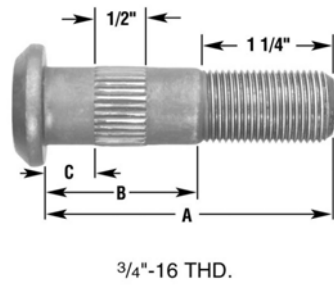
	EUCLID NO.	REPLACES	A	B	C	NOTES
<p>GRADE 8</p>  <p style="text-align: center;">3/4"-16 THD.</p>	E-4964-L	Budd 59365 Nwra X-1859	2-1/8"	3/4"	1/4"	Used on TK, TKL, RL, TL (also Eaton). With some cast drums on TK, TKL, use E-4968-R/L. Used on RN, RQ, TKN.
	E-4964-R	Budd 59364 Nwra X-1858				
	E-4965-L	Meritor 20X1805 Navistar 22423V Trailmobile 50-33A-28 Budd 59192 Navistar 878211R1 Gunite K36708 Nwra X-1081	2-3/8"	1"		
	E-4965-R	Meritor 20X1806 Navistar 22422V Trailmobile 50-33A-27 Budd 59191 Navistar 878210R1 Gunite K36707 Nwra X-1080				
	E-4966-L	Dayton-Walther 09-853602 Navistar 184197R1 Meritor 20X431 Trailmobile 50-33A-30 Budd 59264 Navistar 983878R1 Fruehauf MWC-X01713 Nwra X-1713	2-5/8"	1-1/4"	5/16"	
	E-4966-R	Dayton-Walther 09-853601 Navistar 184198R1 Meritor 20X430 Trailmobile 50-33A-29 Budd 59263 Navistar 793879R1 Fruehauf MWC-X01712 Nwra X-1712				
	E-4967-L	Meritor 20X1575, 20X1811 GMC 3723967 Budd 61969 Nwra X-1824	2-7/8"	1-1/2"	1/4"	
	E-4967-R	Meritor 20X1576, 20X1812 GMC 3723968 Budd 61968 Nwra X-1823				
	E-4968-L	Webb 198521 Meritor 20X1571, 20X997 Budd 49852 Trailmobile 50-33A-26 Volvo 6043826 Fruehauf MWC-X01385 Nwra X-1385, X-2042			1/2"	
	E-4968-R	Webb 198510 Meritor 20X1572, 20X996 Meritor 20X1816 Budd 49851 Trailmobile 50-33A-25 Volvo 6043825 Fruehauf MWC-X01384 Nwra X-1384				

WHEEL STUDS

SERRATED WHEEL STUDS - Stud Body Diameter .784

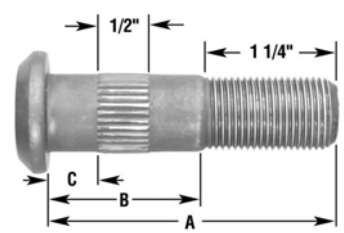
GRADE 8  3/4"-16 THD.	EUCLID NO.	REPLACES	A	B	C	NOTES Used on TK, TKL, RL, TL (also Eaton). With some cast drums on TK, TKL, use E-4968-R/L. Used on RN, RQ, TKN.
	E-4969-L	Meritor 20X1469 Budd 59184 Trailmobile 700-7-79 Fruehauf MWC-X01387 Nwra X-1387	3-1/8"	1-3/4"	9/16"	
	E-4969-R	Meritor 20X1470 Budd 59183 Trailmobile 700-7-77 Fruehauf MWC-X01386 Nwra X-1386				
	E-5869-L	Budd 59372 Nwra X-1711	4-1/8"	2-3/4"		
	E-5869-R	Budd 59371 Nwra X-1710				

SERRATED WHEEL STUDS

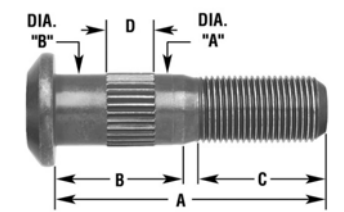
GRADE 8  3/4"-16 THD.	EUCLID NO.	REPLACES	STUD BODY DIA.		A	B	C	D		
			"A"	"B"						
	E-8947-L	Budd 100146 Webb 159183 Erie 5309LH Nwra X1715	.777	.784	2-31/32"	1-13/32"	1-1/16"	1/2"		
	E-8947-R	Budd 100145 Webb 159184 Trailmobile 36-159184 Erie 5308RH Nwra X1714								
	E-9003-L	Meritor 20X1467 Meritor 20X1811	.779	.779	2-29/32"	1-1/16"	1-19/32"	5/16"		
	E-9003-R	Meritor 20X1468 Meritor 20X1812								
	E-11662-L	Meritor 09001526	.784	.790	2-35/64"	1-9/64"	1-1/8"	1/2"		
	E-11662-R	Meritor 09001525								
	E-9008-L	Webb 100163	.786	.786	3-3/8"	1-13/32"	1-21/32"			
	E-9008-R	Webb 100164								
	E-11665-L	Meritor 09001556	.875	.975	2-3/8"	1-3/32"	1-5/32"	7/16"		
	E-11665-R	Meritor 09001555								
	E-11659-L	Meritor 09001998	.890	.939			5/764"	1-1/4"	1/2"	
	E-11659-R	Meritor 09001997								
	E-11661-L	Meritor 09002050							1-1/8"	
	E-11661-R	Meritor 09002049								
	E-11674-L	Meritor 09001983					1"	1-1/4"	3/4"	
	E-11674-R	Meritor 09001982								
	E-11676-L	Meritor 09001992				2-5/8"	5/764"	1-3/8"	1/2"	
	E-11676-R	Meritor 09001991								
	E-11672-L	Meritor 09001911 Paccar SVVN610 Paccar SVVN611					1-1/64"			
	E-11672-R	Meritor 09001910 Paccar SVVN609								

WHEEL STUDS

SERRATED WHEEL STUDS

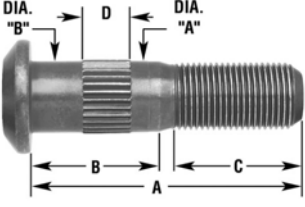
GRADE 8 	EUCID NO.	REPLACES	STUD BODY DIA.		A	B	C	D
			"A"	"B"				
	E-11678-L	Meritor 09002086	.890	.939	2-49/64"	7/8"	1-39/64"	1/2"
	E-11678-R	Meritor 09002085						
	E-11675-L	Meritor 09001985			2-53/64"	1"	1-11/16"	3/4"
	E-11675-R	Meritor 09001984						
	E-11677-L	Meritor 09001996 Paccar SVVN615			3-3/64"	57/64"	1-51/64"	1/2"
	E-11677-R	Meritor 09001995 Paccar SVVN614						

4

SERRATED WHEEL STUDS - Stud Body Diameter .784

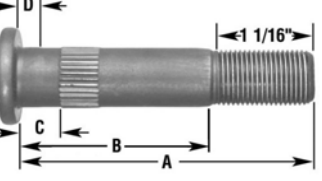
GRADE 8 	EUCID NO.	REPLACES	A	B	C	D
	E-5764-L	Navistar 332528C1 Budd 90554 NWRA X-1689	2-3/8"	1"	3/8"	3/16"
	E-5764-R	Navistar 332529C1 Budd 90553 NWRA X-1688				
	E-5870-L	Meritor 20X1809 Budd 90514 NWRA X-1693	2-5/8"	1-1/4"	7/16"	
	E-5870-R	Meritor 20X1810 Budd 90513 NWRA X-1692				
	E-5775	World Truck 15418003 World Truck 168-1015R Dana/Spicer 50-1126 Budd 85108 Ford C3TZ1118A NWRA X-2100	2-3/4"	1-3/8"	1/2"	1/4"
	E-5776	Budd 85141 NWRA X-1700				
	E-5756-L	Budd 59067 Trailmobile 8-9-37 Fruehauf MWC-X01705 NWRA X-1705	3-3/8"	2"	9/16"	
	E-5756-R	Budd 59066 Trailmobile 8-9-36 Fruehauf MWC-X01704 NWRA X-1704				
	E-5765-L	Budd 84098 Fruehauf MWC-X01703 NWRA X-1703	3-5/8"	2-1/4"	9/16"	5/16"
	E-5765-R	Budd 84097 Fruehauf MWC-X01702 NWRA X-1702				
	E-5757-L	Budd 59376 Fruehauf MWC-X01707 NWRA X-1707	3-5/8"	2-1/4"	9/16"	5/16"
	E-5757-R	Budd 59375 Fruehauf MWC-X01706 NWRA X-1706				

WHEEL STUDS

SERRATED WHEEL STUDS - Stud Body Diameter .784

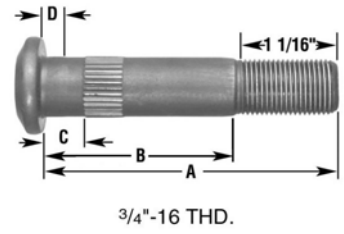
GRADE 8 	EUCID NO.	REPLACES	A	B	C	D
		E-5766-L	Budd 59374 Fruehauf MWC-X01709 Nwra X-1709	3-7/8"	2-1/2"	9/16"
	E-5766-R	Budd 59373 Fruehauf MWC-X01708 Nwra X-1708				

SERRATED WHEEL STUDS - Stud Body Diameter .594

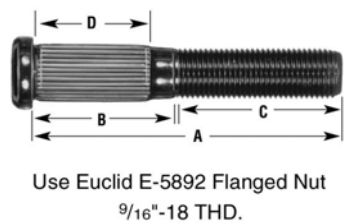
GRADE 8 	EUCLID NO.	REPLACES	A	B	C	D
		E-5724	Budd 31439 Meritor 4X199	3-1/4"	1-5/8"	1-5/8"

SERRATED WHEEL STUDS - Stud Body Diameter .606

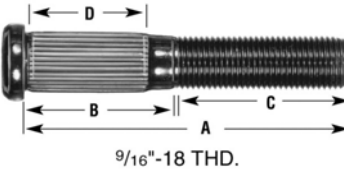
GRADE 8 	EUCLID NO.	REPLACES	A	B	C	D
	E-8963	GMC 3988538 Nwra X1473	3"	1-1/16"	1-1/4"	7/8"
	E-8964	GMC 334386	3-1/2"	1-1/16"	1-5/8"	7/8"
	E-8965	GMC 355815 Nwra X1424	3-19/32"	1-9/32"	2"	7/8"

SERRATED WHEEL STUDS

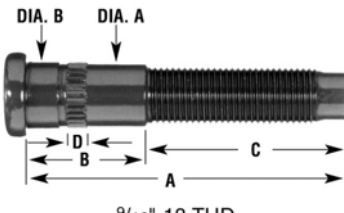
GRADE 8 	EUCLID NO.	REPLACES	STUD BODY DIA.		A	B	C	D
			"A"	"B"				
	E-8959-L	Ford 388381 Ford DOTZ1119A	.600"	.641"	2-13/16"	1-1/8"	1-5/8"	5/16"
	E-8959-R	Ford 388380 Ford DOTZ1107A						



an **ArvinMeritor**™ brand

WHEEL STUDS

SERRATED WHEEL STUDS

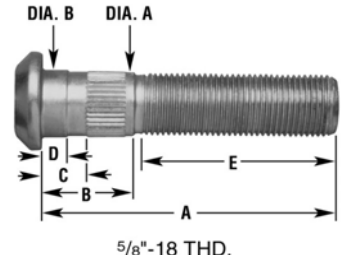
 <p>GRADE 8</p> <p>DIA. B DIA. A</p> <p>D C E</p> <p>B A</p> <p>5/8"-18 THD.</p>	EUCID NO.	REPLACES	STUD BODY DIA.		A	B	C	D	E
			"A"	"B"					
			E-8946-L	Budd 98349 NWRA X1842					
E-8946-R	Budd 98348 NWRA X1841								

4

SERRATED WHEEL STUDS - Stud Body Diameter .730

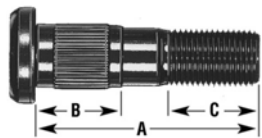
 <p>GRADE 8</p> <p>B A C</p> <p>1 1/16"-16 THD.</p>	EUCLID NO.	REPLACES	A	B	C		
			E-5682	GMC 3763619 Budd 82525 Gunite K46009 NWRA X-1108	2-5/8"	1"	1-1/8"
			E-5683	GMC 3765876 Gunite 46009 Budd 82526 NWRA X-1109	3-1/4"	1"	1-1/2"
E-5816	Gunite 46010 Budd 83172	3-1/4"	1-21/64"	1-23/64"			

SERRATED WHEEL STUDS

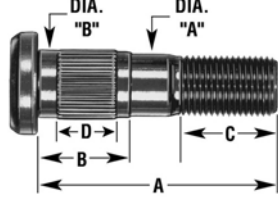
 <p>GRADE 8</p> <p>DIA. "B" DIA. "A"</p> <p>D C</p> <p>B A</p> <p>1 1/16"-16 THD.</p>	EUCLID NO.	REPLACES	STUD BODY DIA.		A	B	C	D
			"A"	"B"				
			E-8962	GMC 3874369				
E-8961	GMC 704173	.757	.757	3-5/8"	1-5/16"	1-31/32"	1/2"	

SERRATED WHEEL STUDS

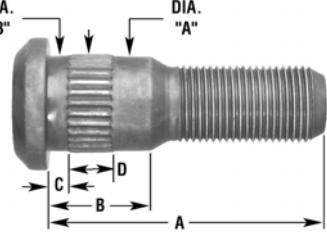
 <p>GRADE 8</p> <p>DIA. "B" DIA. "A"</p> <p>C D</p> <p>B A</p> <p>3/4"-16 THD.</p>	EUCLID NO.	REPLACES	STUD BODY DIA.		A	B	C	D
			"A"	"B"				
			E-5632	Motor Wheel 83028				
E-8949-L	Budd 106202 Budd 3008402	.902	.910	2-19/32"	31/32"	7/32"	13/32"	
E-8949-R	Budd 106201 Budd 3008401 Ford E9HZ1151A							

WHEEL STUDS

"D" HEAD STUDS - Stud Body Diameter .888 - For Dura-Light Hubs

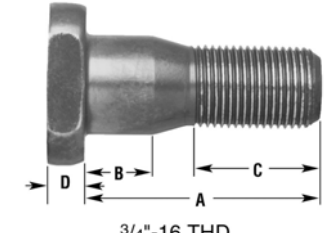
 <p>3/4"-16 THD.</p>	EUCLID NO.	REPLACES	A	B	C	D	
	E-10258-L			2-1/16"	5/8"	1-1/8"	5/16"
	E-10258-R						
	E-10259-L			2-11/32"	1-3/8"		
	E-10259-R						

"D" HEAD STUDS - Stud Body Diameter .874

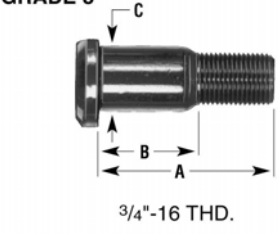
 <p>3/4"-16 THD.</p>	EUCLID NO.	REPLACES	A	B	C	
	E-5587-L	Budd 35787 Nwra X-1396		2"	25/32"	31/32"
	E-5587-R	Budd 35786 Nwra X-1395				
	E-4988-L	Gunite 20049 Meritor 20X655 Budd 40337 Budd 43802 Ford 511108 Fruehauf 536365 Navistar 69327R2 Nwra X-1051		2-1/4"	1-1/32"	1-21/64"
	E-4988-R	Gunite 20048 Meritor 20X656 Budd 40336 Budd 43801 Ford 511107 Navistar 69328R2 Nwra X-1050				
	E-5588-L	Budd 40339 Ford 81T1119 Nwra X-1398		2-3/8"	1-3/16"	1-15/32"
	E-5588-R	Budd 40338 Ford 81T1118 Nwra X-1397				
	E-5618-L	Meritor 20X121 Budd 59537 Navistar 59790R1 Nwra X-1667		2-39/64"	1-5/16"	
	E-5618-R	Meritor 20X120 Budd 59536 Navistar 59791R1 Nwra X-1666				

For additional: Parts Information
 Cross Reference
 visit our online catalog at: www.XpresswayPlus.com

WHEEL STUDS

CLIPPED HEAD STUDS - Stud Body Diameter .907 - Plain Body

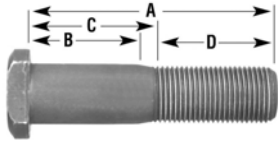
GRADE 8  3/4"-16 THD.	EUCLID NO.	REPLACES	A	B	C	D
	E-11685-L	Meritor 09002024	2-3/32"	7/16"	23/32"	1-25/64"
	E-11685-R	Meritor 09002023				
	E-11684-L	Meritor 09002022	2-3/8"	7/16"	23/32"	1-21/32"
	E-11684-R	Meritor 09002021				
	E-11686-L	Meritor 09002026	2-25/64"	7/16"	23/32"	1-43/64"
	E-11686-R	Meritor 09002025				
	E-11687-L	Meritor 09002028	2-43/64"	7/16"	23/32"	1-61/64"
	E-11687-R	Meritor 09002027				

4

CLIPPED HEAD STUDS - Stud Body Diameter .910

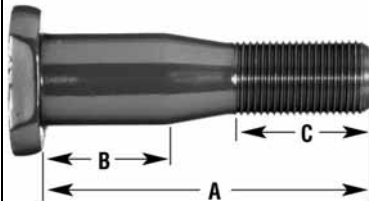
GRADE 8  3/4"-16 THD.	EUCLID NO.	REPLACES	A	B	C
	E-8952-L	Conmet 101773 Motor Wheel 90442	3-5/32"	1-3/16"	1-1/4"
E-8952-R	Conmet 101774 Motor Wheel 90441				

CLIPPED HEAD STUDS - Stud Body Diameter .785 - Plain Body For Aluminum Hubs

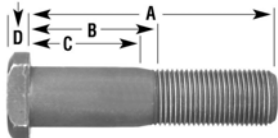
GRADE 8  3/4"-16 THD.	EUCLID NO.	REPLACES	A	B	C	D
	E-10213-L	Paccar K03	3-5/16"	1-1/8"	15/16"	5/16"
	E-10213-R	Paccar K04				
	E-6026-L	Conmet 100012 Fruehauf MWC-101150 NWRA X2199	3-5/32"	1-23/32"	1-13/32"	1/4"
	E-6026-R	Conmet 100013 Fruehauf MWC-101150 NWRA X2198				
	E-6058-L	Conmet 100368 Freightliner 11108390 NWRA X2203	3-1/4"	1-7/8"	1-17/32"	1/4"
	E-6058-R	Conmet 100369 Freightliner 11108391 NWRA X2202				
	E-10214-L	Paccar K05	3-5/16"	1-3/4"	15/16"	5/16"
	E-10214-R	Paccar K06				
	E-6027-L	Conmet 100255 Fruehauf MWC-101150 NWRA X2209	3-13/32"	1-3/4"	1-13/32"	1/4"
	E-6027-R	Conmet 100254 Fruehauf MWC-101150 NWRA X2208				
	E-6059-L	Conmet 100370 Freightliner 11108392 NWRA X2205	3-17/32"	1-29/32"	1-9/16"	1/4"
	E-6059-R	Conmet 100371 Freightliner 11108393 NWRA X2204				
	E-6028-L	Conmet 100372,100226 NWRA X2200	3-25/32"	1-3/4"	1-13/32"	1/4"
	E-6028-R	Conmet 100373,100225 NWRA X2201				

WHEEL STUDS

CLIPPED HEAD STUDS - Stud Body Diameter 1.224 - Plain Body

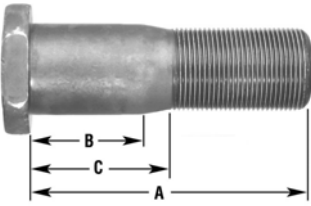
GRADE 8  1 1/8"-16 THD.	EUCLID NO.	REPLACES	A	B	C
	E-8950-L	Conmet 100149 Conmet 100264 Nwra X2207	3-23/32"	1-1/2"	1-3/4"
E-8950-R	Conmet 100148 Conmet 100265 Nwra X2206				

CLIPPED HEAD STUDS - Stud Body Diameter .624

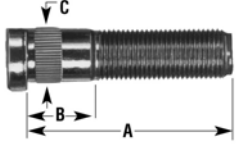
GRADE 8  5/8"-18 THD.	EUCLID NO.	REPLACES	A	B	C
	E-5610-L	Budd 67144 Budd 67459 Budd 67559 Budd 74726 Gunitite K36734 Nwra X1287	2-1/8"	13/16"	21/32"
	E-5610-R	Budd 67143 Budd 67458 Budd 67558 Budd 74725 Gunitite K36733 Nwra X1286 Nwra X2033			
	E-5612-L	Budd 67462 Nwra X-1251	2-7/16"		
	E-5612-R	Budd 3006201 Budd 67461 Nwra X-1250			

WHEEL STUDS - METRIC

METRIC ROUND COLLAR SHOULDER STUDS - Stud Body Diameter .781

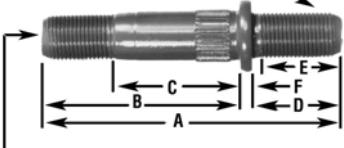
GRADE 8 M22 x 1.5 - 6g (RH) THDS.  3/4"-16 (RH) THDS.	EUCLID NO.	REPLACES	A	B	C	D	E	F
	E-11724	Meritor 09002073		5-35/64"	2-57/64"	1-41/64"	2-9/16"	2-1/4"
E-11725	Meritor 09002140		6-13/32"	2-57/64"	1-7/16"	3-7/16"	3-7/64"	3/32"



an **ArvinMeritor**™ brand

WHEEL STUDS - METRIC

METRIC CLIPPED HEAD STUDS - Stud Body Diameter .907 - Plain Body

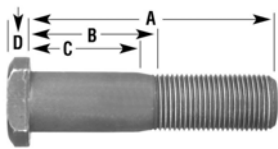
GRADE 10.9*	EUCLID NO.	REPLACES	A	B	C	D
			 <p style="text-align: center;">M22X1.5</p>	E-11693	Meritor 09001962 Paccar SVVN611	3-1/2"
	E-11692	Meritor 09001914	4-3/8"	61/64"	29/64"	5/16"

METRIC SERRATED STUDS - Stud Body Diameter .791

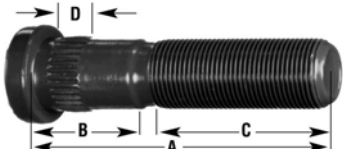
GRADE 10.9*	EUCLID NO.	REPLACES	A	B	C	D
			 <p style="text-align: center;">M20X1.5 THD.</p>	E-11706	Meritor 09001853	2-3/4"
	E-11712	Meritor 09001990	2-59/64"	3/4"	2-11/64"	3/8"
	E-11703	Meritor 09001811	3-11/16"	1-17/64"	2-27/64"	3/8"
	E-11707	Meritor 09001855	3-7/8"	1-1/4"	2-5/8"	3/8"
	E-11709	Meritor 09001964	4-11/64"	1-1/4"	2-59/64"	3/8"

METRIC CLIPPED HEAD STUDS - Stud Body Diameter .981

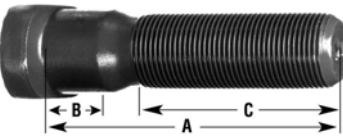
GRADE 10.9*	EUCLID NO.	REPLACES	A	B	C
			 <p style="text-align: center;">M22X1.5 THD. E-5992A is "D" Head</p>	E-5994	Motor Wheel 88808 Fruehauf MWC-X02141 NWRA X-2141
	E-5992A	Meritor R005992 Meritor R005992A	3-9/16"	23/32"	2-15/32"
	E-5993	Motor Wheel 88799 NWRA X-2140	4-1/8"	23/32"	3-1/16"
	E-8997	Motor Wheel 89620	4-23/32"	5/8"	3-3/4"

Stud Body Diameter .910 METRIC "D" HEAD STUDS - Stud Body Diameter .910

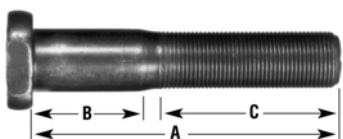
GRADE 10.9*	EUCLID NO.	REPLACES	A	B	C
			 <p style="text-align: center;">M22X1.5 THD.</p>	E-6029A	Conmet 101151 Motor Wheel 89983 Fruehauf MWC-101151
	E-6001A	Conmet 101171 Motor Wheel 89774 Fruehauf MWC-089774	4-31/32"	1-19/64"	3-1/4"
	E-6030A	Conmet 101150 Fruehauf MWC-101150	5-1/4"	1-19/64"	3-11/32"

For additional: Parts Information
Cross Reference

visit our online catalog at: www.XpresswayPlus.com

WHEEL STUDS - METRIC

METRIC SERRATED STUDS

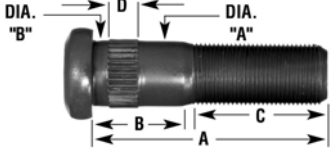
GRADE 10.9*  M22X1.5 THD.	EUCLID NO.	REPLACES	STUD BODY DIA.		A	B	C	D
			"A"	"B"				
		E-8960	Ford E6HZ1107A	.982	1.001	3-7/16"	2"	1"
	E-8991	Mack 5000438684	.983	1.002	3-15/32"	1-13/16"	1-3/32"	11/32"

METRIC SERRATED STUDS - Stud Body Diameter .901

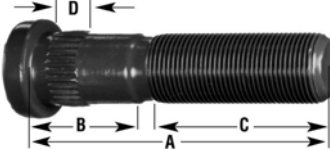
GRADE 10.9*  M22X1.5 THD.	EUCLID NO.	REPLACES	A	B	C	D
				E-5998	Budd 106377 Budd 3018502 Fruehauf MWC-X02157 NWRA X-2157	3-3/16"
	E-5997	Budd 106216 Budd 3018503 Fruehauf MWC-X02155 NWRA X-2155	3-21/32"	7/8"	2-29/64"	13/32"
	E-5999	Budd 106397 Budd 3018501 NWRA X-2158	4-9/16"	7/8"	3-13/32"	13/32"

METRIC SERRATED STUDS - Stud Body Diameter .890

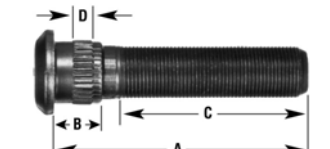
GRADE 10.9*  M22X1.5 THD.	EUCLID NO.	REPLACES	A	B	C	D
				E-11708	Meritor 09001958	2-49/64"
	E-11718	Meritor 09002013	2-13/16"	7/8"	1-11/16"	3/8"
	E-11710	Meritor 09001988 Paccar SVVN612	3-11/32"	7/8"	2-15/64"	3/8"
	E-11714	Paccar SVVN617 Meritor 09002002	3-39/64"	7/8"	2-43/64"	3/8"
	E-11713	Meritor 09002001 Paccar SVVN616	3-27/32"	7/8"	2-11/16"	3/8"
	E-11717	Meritor 09002005	3-27/32"	1-1/8"	2-5/8"	3/8"
	E-11701	Meritor 09001727	3-7/8"	7/8"	2-3/4"	3/8"
	E-11716	Meritor 09002004 Paccar SVVN619	4-11/64"	7/8"	3-1/64"	3/8"
	E-11702	Meritor 09001728	4-5/16"	7/8"	3-3/16"	3/8"
	E-11715	Meritor 09002003 Paccar SVVN618	4-25/32"	7/8"	3-27/32"	3/8"

METRIC SERRATED STUDS - Stud Body Diameter .791

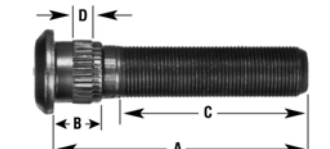
GRADE 10.9*  M20X1.5 THD.	EUCLID NO.	REPLACES	A	B	C	D
				E-11704	Meritor 09001825	2-35/64"
	E-11705	Meritor 09001826	3-7/64"	63/64"	2-1/8"	3/8"

WHEEL STUDS - METRIC

METRIC SERRATED STUDS - Stud Body Diameter .901

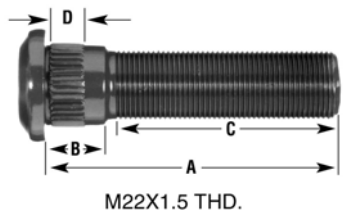
GRADE 10.9*  M22X1.5 THD.	EUCLID NO.	REPLACES	A	B	C	D
		E-11719	Meritor 09002184	2-15/16"	7/8"	1-49/64"

METRIC SERRATED STUDS - Stud Body Diameter .910

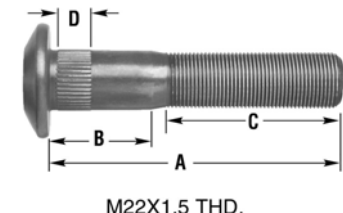
GRADE 10.9*  M22X1.5 THD.	EUCLID NO.	REPLACES	A	B	C	D
		E-10222	Conmet 103193	3-21/32"	1-7/32"	2-3/32"
	E-10218	Conmet 102033	3-31/32"	1-9/16"	2-1/16"	1/2"
	E-10215	Conmet 102188 Motor Wheel 91161	4-3/32"	1-1/16"	2-11/32"	1/2"
	E-10223	Conmet 103431	4-5/32"	1-7/32"	2-3/32"	1/2"
	E-10219	Conmet 102290 Motor Wheel 91165	4-15/32"	1-9/16"	2-9/16"	1/2"
	E-10216	Conmet 102189 Motor Wheel 91159	4-19/32"	1-1/16"	2-27/32"	1/2"
	E-10217	Conmet 102190	4-31/32"	1-1/16"	3-7/32"	1/2"
	E-10220	Conmet 102291 Motor Wheel 91163	4-31/32"	1-9/16"	3-1/16"	1/2"
	E-10221	Conmet 102292	5-11/32"	1-9/16"	3-7/16"	1/2"

METRIC SERRATED STUDS - Stud Body Diameter .975

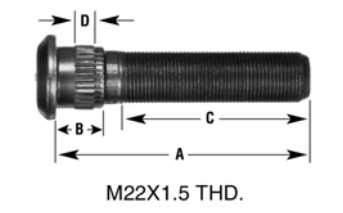
GRADE 10.9*  M22X1.5 THD.	EUCLID NO.	REPLACES	A	B	C	D
		E-9009	Navistar 1660579C1 World Truck 168-1047	2-9/16"	23/32"	1-11/16"
	E-10242	Webb 101191	2-29/32"	23/32"	1-21/32"	3/8"
	E-10675	Gunite W1234 Gunite W1324	3-1/2"	11/16"	2-1/2"	1/2"
	E-6036	Webb 101164	3-1/2"	23/32"	2-1/4"	3/8"
	E-8988	Gunite W1246	3-11/16"	7/8"	2-11/32"	1/2"
	E-6035	Webb 101162 Webb 36-101162 Erie 5324RH	3-15/16"	23/32"	2-11/16"	3/8"
	E-8981	Gunite W1164	4"	7/8"	2-29/32"	1/2"
	E-10676	Gunite W-1249 Gunite W1196 Gunite W1327 Gunite W1403	4-1/4"	7/16"	3-1/4"	1/2"
	E-9526	Webb 101161	4-5/16"	23/32"	3-1/16"	3/8"
	E-6034	Webb 101160 Webb 36-101160 Erie 5322RH	4-25/32"	23/32"	3-17/32"	3/8"
	E-8980	Gunite W1160	5-3/32"	7/8"	3-3/4"	1/2"
	E-8987	Navistar 1652875C1 Gunite W1211	5-3/16"	1-1/16"	3-23/32"	1/2"

WHEEL STUDS - METRIC

METRIC SERRATED STUDS - Stud Body Diameter 1.22

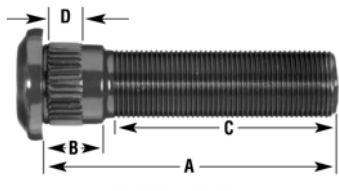
GRADE 10.9*	EUCLID NO.	REPLACES	A	B	C	D
	 <p>M22X1.5 THD.</p>	E-8986	Gunite W1205	4-13/32"	1-3/16"	2-7/8"

METRIC SERRATED STUDS - Stud Body Diameter .888

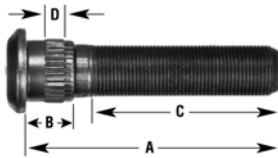
GRADE 10.9*	EUCLID NO.	REPLACES	A	B	C	D
	 <p>M22X1.5 THD.</p>	E-9837	Dayton-Walther 09-001740 Dayton-Walther 09-001989 Navistar 1658475C1 Volvo White GMC 3133400 Paccar SVVN613	3-23/32"	7/8"	2-9/16"

METRIC CLIPPED "D" HEAD STUDS - Stud Body Diameter .888 - For Dura-Light Hubs

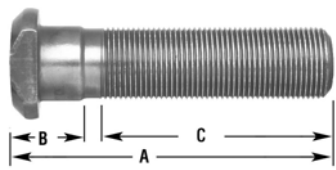
GRADE 10.9*	EUCLID NO.	REPLACES	A	B	C
	 <p>M22X1.5 THD.</p>	E-10256		3-3/8"	1/2"
E-10257			4-3/16"	1/2"	3-5/16"

DRIVE FLANGE STUDS

BUDD, DAYTON, GUNITE, MERITOR

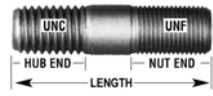
GRADE 8	EUCLID NO.	REPLACES	BODY DIA.	LENGTH	HUB END		NUT END	
					THREAD	THREAD LENGTH	THREAD	THREAD LENGTH
	E-5796	Dayton-Walther 08-007358 Dayton-Walther 08-201758 Webb 142022 Budd 42793 Navistar 467018C1 Navistar 72169R1 Meritor SC718 Meritor SC7181 Gunite WP-28 NWRA X-1787	7/16"	2-5/32"	7/16"-14	9/16"	7/16"-20	15/16"
	E-5798	Navistar 111428H Budd 37181 Budd 44577 Navistar 60793R2 Meritor SC819 Meritor SC8191 NWRA X-1790	1/2"	2-3/8"	1/2"-13	13/16"	1/2"-20	7/8"

* Grade 10.9 is the metric equivalent of Grade 8.

DRIVE FLANGE STUDS

BUDD, DAYTON, GUNITE, MERITOR

	EUCLID NO.	REPLACES	BODY DIA.	LENGTH	HUB END		NUT END	
					THREAD	THREAD LENGTH	THREAD	THREAD LENGTH
	E-5799	Dayton-Walther 08-004350 Webb 152026 Budd 19937 Gunitite WP-81 NWRA X-1777	1/2"	2-1/2"	1/2"-13	3/4"	1/2"-20	13/16"
	E-11649	Meritor 08205435		2-7/8"		53/64"		63/64"
	E-11648	Meritor 08205373		3"		1"	1/2"-13	1"
	E-11652	Meritor 08205741		3-1/32"				
	E-5944	Meritor 4X1612 Gunitite WP-693	9/16"	2-1/2"	9/16"-12	13/16"	9/16"-18	7/8"
	E-11647	Meritor 08205435				1"		29/32"
	E-11650	Meritor 08205575		2-59/64"		1-1/4"		1"
	E-11646	Meritor 08007591		2-7/8"	5/8"-11	1-5/32"	5/8"-18	1-1/8"
	E-11651	Meritor 08205740	5/8"	2-15/16"		27/32"	5/8"-11	1-3/8"
	E-11654	Meritor 08205833		3-1/32"		61/64"	5/8"-18	1-23/64"
	E-5946	Meritor SC1020		2-1/2"		15/16"		1"
	E-5800	Dayton-Walther 08-007775 Navistar 119345H Budd 63606 Meritor SC1022 Meritor SC10221 Paccar SVVN605 Gunitite WP-174 NWRA X-1792		2-3/4"		1"		
	E-5947	Navistar 684368R1 Meritor SC1023 Meritor SC10231		2-7/8"		15/16"		
	E-5954	Dayton-Walther 08-008551				1"		1-1/16"
	E-5801	Budd 48966 NWRA X-1793		3-1/16"		1-1/8"		
	E-5949	Meritor SC1026 Meritor SC10261		3-1/4"		15/16"		1"
	E-5872	Conmet 100383 World Truck 1511011 Trailmobile 38-5872 Meritor 4X1027 Dana/Spicer 54-1621 Navistar 60421R1 Motor Wheel 86478 Kenworth K233B305		3-11/16"		1-17/32"		1-1/8"
	E-5955	Dayton-Walther 08-007471 Navistar 611428 Navistar 61142H	3/4"	3-1/4"	3/4"-10	1-1/8"	3/4"-16	1-1/4"
	E-11655	Meritor 08205879		3-5/16"		1-3/64"		1-17/32"
	E-4960	Budd 37173 Budd 37179 Budd 3927302 Budd 49328 Meritor 4X1207 Navistar 55585H Budd 99357 Gunitite WP-39		3-3/4"		1-1/8"		1-5/8"

GRADE 8



S.O.S.

Special Order Service

Can't find it?

Trouble sourcing products?

Need assistance?

Let Euclid's Special Order Service (S.O.S.) help you find your parts.

Euclid's position as the market leader provides you access to a comprehensive array of truck parts products from the industry's leading manufacturers. Through Euclid, these entire product lines are available to you just by placing a phone call to Euclid's S.O.S. Department at 866-238-2543 (option 2) in the U.S. or 800-387-3889 in Canada.



an **ArvinMeritor™** brand

DRIVE FLANGE STUDS

DRIVE FLANGE & GENERAL PURPOSE STUDS

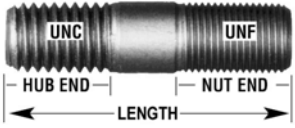
GRADE 8	EUCLID NO.	BODY DIA.	LENGTH	HUB END		NUT END			
				THREAD	THREAD LENGTH	THREAD	THREAD LENGTH		
	E-4942	1/2"	2"	1/2"-13	11/16"	1/2"-20	1-1/16"		
	E-4944		2-1/2"		13/16"		1-3/16"		
	E-4945		2-3/4"		15/16"		1-7/16"		
	E-4946		3"		1-3/4"				
	E-4947		3-1/2"		2-1/4"				
	E-4948	9/16"	2-1/2"	1/2"-13	7/8"	1/2"-20	1-1/4"		
	E-4949		2-3/4"	9/16"-12	15/16"		9/16"-18	1-1/2"	
	E-4950		3-1/4"					1-15/16"	
	E-4951	5/8"	2-5/8"	5/8"-11			5/8"-18	1-1/4"	
	E-5702							1-1/16"	1-1/16"
	E-4952							3"	1-13/16"
	E-4953							3-1/2"	2-1/4"

4

METRIC

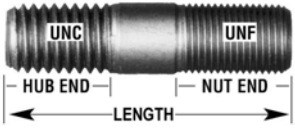
GRADE 10.9	EUCLID NO.	BODY DIA.	LENGTH	HUB END		NUT END	
				THREAD	THREAD LENGTH	THREAD	THREAD LENGTH
	E-11657	5/8"	2-23/32"	5/8"-11	27/32"	M16 x 1.5-6g	31/32"

If you detect any **errors** in this Catalog, please let us know.

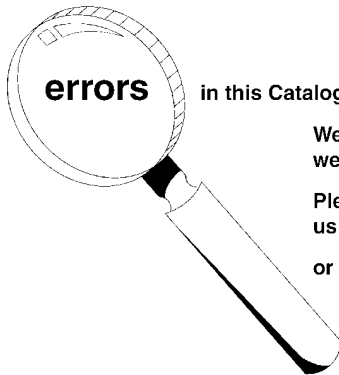

We want the information to be as accurate as possible; we appreciate your help in making it so.

Please e-mail any comments/suggestions/corrections to us at: catalogfeedback@arvinmeritor.com

or mail to: Euclid Industries, LLC
Attn: Catalog Dept.
7975 Dixie Highway
Florence, KY 41042-2754

XpresswayPlus.com



Don't forget about using *XpresswayPlus.com* for:

- Ordering parts online
- Order status
- Price and availability
- Visual search for new users
- Online e-mail or phone numbers for Customer Service, Information Services, Marketing, Catalog, and eSupport
- Reference Library
- The Company Store
- Easy to use navigating instructions
- Dealer/Distributor locator

XpresswayPlus is easy to find, can reduce phone calls, and save you valuable time.

WHAT YOU NEED:	WHERE TO LOOK:
ACCOUNT CHANGE	CUSTOMER SERVICE
AFTERMARKET & PRODUCTION ASSEMBLIES	CATALOG
APPLICATION INFORMATION	CATALOG
BILL-OF-LADING NUMBER	ORDER STATUS
BILL-OF-MATERIAL	CATALOG
BULLETINS	REFERENCE LIBRARY
CONTACT NAMES & NUMBERS	CUSTOMER SERVICE
FIELD SUPPORT REPRESENTATIVES	CUSTOMER SERVICE
INVOICE (VIEW & PRINT)	ORDER STATUS
NEWSLETTER	REFERENCE LIBRARY
ORDER DETAILS	ORDER STATUS
ORDER HISTORY FILE	ORDER STATUS
ORDER MERCHANDISE	COMPANY STORE
ORDER SUBMIT	CREATE NEW ORDER
ORDER SUBMIT - STOCK UPLOAD (MULTIPLE LINES)	CREATE NEW ORDER
PART DETAILS	CATALOG
PART IMAGES	CATALOG
PART NUMBER COMPARISON	CATALOG
PARTS BOOKS	REFERENCE LIBRARY
PASSWORD CHANGE	CUSTOMER SERVICE
PRICE (LIST)	CATALOG
PRICE (NET) & AVAILABILITY	PRICE & AVAILABILITY
PRODUCT BROCHURES	REFERENCE LIBRARY
PRODUCT UPDATES	REFERENCE LIBRARY
PROOF-OF-DELIVERY	ORDER STATUS
REQUEST-FOR-QUOTATION (FOR MERITOR BRAND)	PRICE REQUEST
SALES LITERATURE	REFERENCE LIBRARY
SEND QUESTIONS, COMMENTS, ISSUES	CONTACT US
SHIPPER NUMBER	ORDER STATUS
TECH TIPS	REFERENCE LIBRARY
TRACKING NUMBER	ORDER STATUS
WARRANTY INFORMATION	REFERENCE LIBRARY
WHERE-USED INFORMATION	CATALOG

DRIVE FLANGE WEDGES

DRIVE FLANGE WEDGE (Plated)

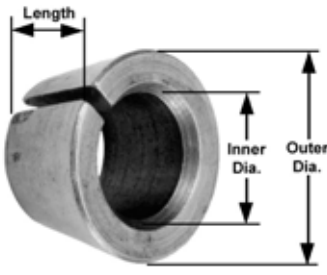
	EUCLID NO.	REPLACES	INNER DIA.	OUTER DIA.	LENGTH
		E-5952	Mack 11EHT31 Meritor 1246Z234 Volvo 467837 Mack 63SP29 Navistar 72342R1	7/16"	11/16"
E-5736		Ford BB1142A	7/16"	3/4"	5/16"
E-5737		Meritor 1246X232 Meritor 1246Z1170 GMC 2124231 Volvo 304981 Mack 35AX600 Navistar 974272R1 Ford BB1142B	7/16"	3/4"	13/32"
E-5738		Ford 3651372	7/16"	13/16"	11/32"
E-5739		Spicer 54-1633	1/2"	13/16"	5/16"
E-5740 ¹		Meritor 1246A1171 Meritor 1246T306 White Truck 466885 Ford 7EQ1142 Navistar 972423R1	1/2"	13/16"	13/32"
E-5957		Mack 11BMT148 Meritor 1246B28 Navistar 132896H1 GMC 652328 Ford C3TZ4A106A	1/2"	7/8"	15/32"
E-5742		Spicer 54-1636	9/16"	7/8"	3/8"
E-5743		Meritor 1246Y233 Navistar 141316H GMC 2019573 Mack 35AX606	5/8"	1"	15/32"
E-5960 ¹		Meritor 1246D290 Meritor 1246V1166 GMC 2231319 Navistar 54700R1 Mack 63SP23 Ford B8QH1142A	5/8"	1"	9/16"
E-10236		Meritor 1246L350	3/4"	1-1/8"	1/2"

4

DRIVE FLANGE NUTS

	EUCLID NO.	REPLACES	THREAD	HEX	HEIGHT
		E-5961	Meritor N17-1 Meritor N47	7/16"-20	11/16"
E-5962		Meritor N48-1 Meritor N48P	1/2"-20	3/4"	9/16"
E-5963		Meritor N19-1	9/16"-18	7/8"	31/64"
E-2002		Mack 20AX7 Meritor N110-1	5/8"-18	15/16"	17/32"
E-5964		Meritor N112-1	3/4"-16	1-1/16"	2-1/32"

¹ Solid wedge - no split.

DRIVE FLANGE NUTS

	EUCLID NO.	REPLACES	THREAD	HEX	HEIGHT
	E-5032	Trailmobile 22-T-1704 Motor Wheel 86897 Fruehauf MRM-OT1704 Fruehauf MRM-T1704D Meritor N18 Meritor N181 NWRA X-1122	1/2"-20	3/4"	7/16"

DRUM BOLT ASSEMBLIES

GRADE 8 	EUCLID NO.	THREAD SIZE	LENGTH
	E-5970	5/8"-18	2"
	E-9261	5/8"-18	2-1/4"
	E-5971	3/4"-10	2"
	E-9262	3/4"-10	2-1/4"
	E-5972	3/4"-16	2"

BRAKE DRUM ATTACHING SCREW

For Outboard Mounting

	EUCLID NO.	REPLACES	THREAD	LENGTH
	E-5018	Ford 35581657 Budd 59891 Motor Wheel 87133 Meritor S788S	1/2" - 13	1"

SPOKE WHEEL & RIM STUDS

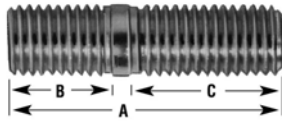

GRADE 8 	EUCLID NO.	REPLACES	A	THREAD	THREAD LENGTH	
					B	C
	E-4955	Dayton-Walther 08-005148 Trailmobile 8-9-5 NWRA B-600 Dana/Spicer H504400 Goodyear ST-69	2-3/8"	5/8" - 11	7/8"	1-7/32"
E-4958	Dayton-Walther 08-006654 Webb 161127 Navistar 260578C1 Ford 35867158B Meritor 4X1424 Trailmobile 8-9-7 Navistar 91872H NWRA B-601 Fruehauf MWC-B00601 Goodyear ST-68 Gunite WP177	2-3/4"	5/8" - 11	7/8"	1-11/16"	

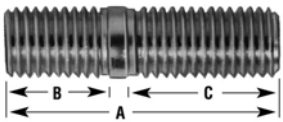
SPOKE WHEEL & RIM STUDS

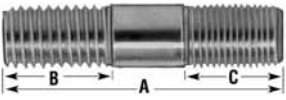
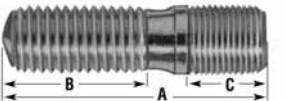
	EUCLID NO.	REPLACES	A	THREAD	THREAD LENGTH	
					B	C
					<p>GRADE 8</p> 	<p>E-4956A</p> <p>Dayton-Walther 08-008411 Dayton-Walther 08-205349 Webb 171027 Erie 5259 Navistar 54494R1 Trailmobile 8-9-8 NWRA B-602 Meritor R004956APL Goodyear ST-29 Gunite W855 Gunite WP147 Gunite WP855</p>
<p>E-5706</p> <p>Dayton-Walther 08-204734 Dayton-Walther 08-205349 NWRA B-612 NWRA B614 Paccar SVVN606 Gunite WP-202 Gunite WP202</p>	<p>3-1/8"</p>	<p>3/4" - 10</p>	<p>1-1/16"</p>	<p>1-7/8"</p>		
<p>E-5726</p> <p>Goodyear ST-178 NWRA X2105</p>	<p>3-1/4"</p>	<p>5/8" - 11</p>	<p>7/8"</p>	<p>1-7/8"</p>		
<p>E-5727</p> <p>Goodyear ST-1298 NWRA X1729</p>	<p>3-1/2"</p>	<p>5/8" - 11</p>	<p>7/8"</p>	<p>1-7/8"</p>		
<p>E-4957</p> <p>Dayton-Walther 08-034396 Dayton-Walther 08-203580 Trailmobile 8-9-18 NWRA B-605</p>	<p>3-9/16"</p>	<p>3/4" - 10</p>	<p>1-5/8"</p>	<p>1-5/8"</p>		
<p>E-5728</p> <p>Goodyear ST-770 NWRA X1730</p>	<p>3-5/8"</p>	<p>3/4" - 10</p>	<p>1-1/16"</p>	<p>2-3/8"</p>		
<p>E-5729</p> <p>Goodyear ST-570 NWRA X2106</p>	<p>4"</p>	<p>3/4" - 10</p>	<p>1-1/16"</p>	<p>2-3/4"</p>		

	EUCLID NO.	REPLACES	A	B		C	
				THREAD	LENGTH	THREAD	LENGTH
				<p>GRADE 8</p> 	<p>E-5887</p> <p>Mack 18AX340 Gunite WP83</p>	<p>2-1/2"</p>	<p>9/16"-12</p>
<p>GRADE 8</p> 	<p>E-4987A</p> <p>Mack 18AX405 NWRA B-606 Gunite WP477</p>	<p>2-7/8"</p>	<p>3/4"-10</p>	<p>1-5/8"</p>	<p>3/4"-16</p>	<p>7/8"</p>	



SPOKE WHEEL & RIM BOLTS

	EUCLID NO.	REPLACES	THREAD	LENGTH	APPLICATION & GENERAL INFORMATION
	E-4989	Erie 5095 Erie 5095R Navistar 68333H Mack 6AX460 Trailmobile 8-9-2 NWRA B610	5/8"-11	2"	Use with E-4962 Nut. Grade 8.
 <p style="text-align: center;">CLIPPED HEAD ROUND BODY</p>	E-5012	Navistar 75887H NWRA N3324	5/8"-11	2"	Clipped head, round body. Use with E-4962 Nut. Grade 8.
	E-5712	Navistar 68333H NWRA B-467	5/8"-11	2-1/16"	Use with E-4962 Nut. Grade 8.
	E-5761	Erie 5247 Erie 5247R NWRA B-607	3/4"-10	2-3/16"	Use with E-4963 Nut. Grade 8.
	E-4990A	Mack 3AX1261 Mack 3AX1901 Meritor R004990	5/8"-11	2-1/4"	Use with E-4962 Nut. Grade 8.

RIM CLAMPS

	EUCLID NO.	REPLACES	A	B	C	D
	E-5036	Navistar 239406R1 Volvo White GMC 852957 Ford 8EQ1042 NWRA C-181 Gunite WP-80	5/8"	2"	2-3/8"	5/8"
	E-5927	Dayton-Walther 09-007587 Dayton-Walther 09-839910 Navistar 215664R1 Navistar 215664R2 Volvo White GMC 499716 NWRA W-83 NWRA W-84	1/2"	2"	2"	5/8"
	E-5926	Dayton-Walther 09-885310 NWRA W-85	1/2"	2"	2"	3/4"

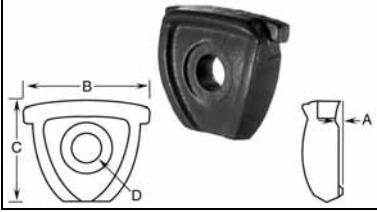
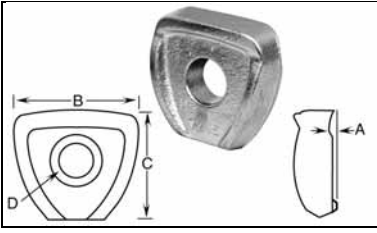
RIM CLAMPS

	EUCLID NO.	REPLACES	A	B	C	D	
	E-5746	Dayton-Walther 09-008422 Mack 12AK2189 Navistar 189446R1 Fruehauf 507305 NWRA W-86	1/4"	3-1/8"	2-5/8"	5/8"	
	EUCLID NO.	REPLACES	A	B	C	D	
	E-5838	Dayton-Walther 09-007295 Mack 15QJ210 Erie E-4	3/16"	2-1/2"	2-5/8"	3/4"	
	EUCLID NO.	REPLACES	A	B	C	D	SPACER WIDTH
	E-5570	Dayton-Walther 09-541417 Webb 15414 GMC 2398446 Trailmobile 8-8-3 Navistar 92134H Volvo White GMC A33768X Erie E4 NWRA W-90	1"	2-7/8"	2-1/2"	5/8"	4"
	E-5571A	Dayton-Walther 09-612317 Mack 15QJ154A Webb 16123 Meritor 3280K7863 Volvo White GMC 426957 Navistar 54493R2 GMC 5667139 Trailmobile 8-8-6 Navistar 973230R1 Erie B Ford D8HT1043AA Erie E1 Erie E19 Erie E20 NWRA XW96	1-1/8"	2-7/8"	2-1/2"	3/4"	4"
	E-5784A	Dayton-Walther 09-870817 Dayton-Walther 09-890817 Webb 16126 Navistar 988339R1 Erie E12 Erie E22 NWRA XW103	1-3/8"	2-7/8"	2-1/2"	3/4"	4"
	E-5045	Dayton-Walther 09-658417 Mack 15QJ118P3 Volvo White GMC 466121A GMC 5767139 Navistar 92135H Erie E5 NWRA W-93	1-7/16"	2-13/16"	2-15/32"	5/8"	3-5/8"

RIM CLAMPS

	EUCLID NO.	REPLACES	A	B	C	D	SPACER WIDTH
		E-5040A	Dayton-Walther 09-699317 Webb 16124 Webb 16129 Volvo White GMC 451061A GMC 576140 GMC 5767140 Trailmobile 8-8-20 Erie E21 Erie E3 NWRA W-98	1-1/2"	2-7/8"	2-1/2"	3/4"
E-5044		Dayton-Walther 09-604017 Mack 15QJ118P2 GMC 2398447 Fruehauf 535406 Trailmobile 8-8-8 Erie E9 NWRA W-91	1-5/8"	2-3/4"	2-1/2"	5/8"	3-3/8"
E-5055		Mack 15QJ223AP	1-3/4"	2-5/8"	2-15/32"	3/4"	3-5/8"
E-5572A		Dayton-Walther 09-623517 GMC 2393267 Volvo White GMC 448888A Fruehauf 535414 Trailmobile 8-8-17 Erie E2 NWRA W-97	1-3/4"	2-7/8"	2-1/2"	3/4"	3-3/8"
E-5785A		Dayton-Walther 09-705317 Dayton-Walther 09-870917 NWRA W-99	1-7/8"	2-7/8"	2-13/32"	3/4"	3-3/8"
E-5839		Dayton-Walther 09-604317	2"	2-7/8"	2-13/32"	5/8"	3"

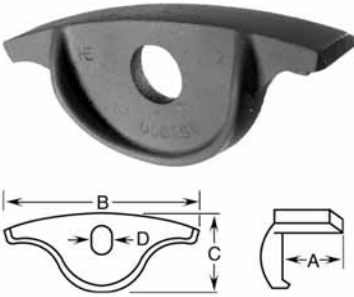
	EUCLID NO.	REPLACES	A	B	C	D	SPACER WIDTH
		E-5827	Dayton-Walther 09-006256 Mack 15QJ16 NWRA W-112	1-1/8"	6"	2-7/16"	3/4"
E-5883		Mack 15QJ16P3	1-5/16"	6"	2-1/2"	3/4"	
E-5829		Dayton-Walther 09-006302 NWRA W-114	1-7/16"	6-5/8"	2-7/16"	3/4"	4"
E-5828		Dayton-Walther 09-006257 Mack 15QJ17P1 Mack 15QJ17P3 NWRA W-113	1-13/16"	6"	2-7/16"	3/4"	3-3/8"

	EUCLID NO.	REPLACES	A	B	C	D	SPACER WIDTH
		E-5573	Mack 15QJ121 Mack 15QJ21 Erie K NWRA XW55K	1-1/8"	3-1/2"	2-1/4"	5/8"
E-5035		Navistar 66091R1 Erie E8 NWRA W-164 NWRA XW164	1-5/16"	2-1/2"	2.56"	5/8"	4-1/4"

RIM CLAMPS

	EUCLID NO.	REPLACES	A	B	C	D
	E-5747	GMC 3778640 Erie E7 NWRA W-227 Gunitite WP-267 NWRA XW227	1-1/16"	2-3/8"	1-3/4"	3/4"
	E-5755	Navistar 868368R1 Navistar 86836R1 NWRA W-228 Gunitite WP368 NWRA XW228	1-5/16"	2-1/4"	1-13/16"	3/4"
	E-5753	GMC 2377906 Gunitite WP-344 NWRA XW191	1-7/16"	2-3/8"	1-13/16"	3/4"
	E-5837	Navistar 578997C1 NWRA W-240 Gunitite WP-398	1-13/16"	2-1/4"	1-13/16"	3/4"

4

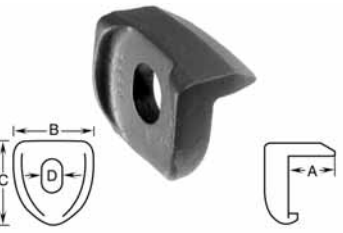
	EUCLID NO.	REPLACES	A	B	C	D
	E-5882	Mack 15QJ223BP1	7/8"	2-1/2"	2-7/16"	3/4"
	E-5823	Mack 15QJ223BP4 NWRA W-189	1-1/8"	2-1/2"	2-7/16"	3/4"
	E-5885	Goodyear CL-1008	1-3/16"	2-1/2"	2-13/32"	3/4"
	E-5822	Mack 15QJ223BP5 Mack 15QJ223CP5 NWRA W-252	1-1/2"	2-1/2"	2-7/16"	3/4"
	E-5820	Mack 15QJ112BP2 Mack 15QJ223BP2	1-5/8"	2-1/2"	2-7/16"	3/4"
	E-5781	Mack 15QJ223BP8 Mack 15QJ223CP8 NWRA W-121	1-7/8"	2-1/2"	2-7/16"	3/4"
	E-5821	Mack 15QJ223BP3 Mack 15QJ223CP3 NWRA W-249	2-1/8"	2-1/2"	2-7/16"	3/4"
	E-5783	Mack 15QJ223BP6 Mack 15QJ223CP6 NWRA W-120	2-3/8"	2-1/2"	2-7/16"	3/4"

	EUCLID NO.	REPLACES	A	B	C	D
	E-5841	GMC 644158		17/32"	1-7/8"	2"

	EUCLID NO.	REPLACES	A	B	C	D	RIM WIDTH
	E-5902	Dayton-Walther 09-001275 Meritor 2257Y1013 Navistar 472277C1 NWRA W-243 Gunitite WP-722		1/2"	2-1/2"	3-5/8"	3/4"

RIM CLAMPS

	EUCLID NO.	REPLACES	A	B	C	D	
	E-9023	Gunite WP725 NWRA XW244	5/8"	2-1/2"	3-5/8"	3/4"	
	EUCLID NO.	REPLACES	A	B	C	D	
	E-5890	Mack 15QJ239 Navistar 386789C1 NWRA C-233 Gunite WP544	1/2"	2"	2-1/8"	3/4"	
	E-5889	NWRA C-232 Gunite WP515	1/2"	2"	2-5/32"	3/4"	
	E-5891	Navistar 512633C1 NWRA C-234 Gunite WP545	3/4"	2"	2-5/32"	3/4"	
	EUCLID NO.	REPLACES	A	B	C	D	
	E-9024	Webb 16177	11/32"	2-5/8"	2-3/4"	3/4"	
	EUCLID NO.	REPLACES	A	B	C	D	TYPE
	E-5754	Navistar 283832C1 GMC 577227 NWRA C-230 Gunite WP-259 Gunite WP455	21/32"	2"	2-9/32"	5/8"	Type 1 Front Wheel
	E-5974	NWRA W-118 Gunite WP682	1-7/16"	2-5/16"	2-11/32"	3/4"	Type 2 Rear Wheel
	EUCLID NO.	REPLACES	A	B	C	D	SPACER WIDTH
	E-5905A ¹	Navistar 403961C1 Ford D8HZ1403B Gunite W-1110 NWRA W-241 Gunite W-858	1-3/16"	2-7/8"	2-3/8"	3/4"	4"
	E-5904A ¹	Gunite W-1138 NWRA W-242 Gunite W-846 NWRA XW255	1-3/8"	2-7/8"	2-3/8"	3/4"	4"
	E-5906	NWRA W-239 Gunite W-866 NWRA XW239	1-5/8"	2-1/4"	2-1/4"	3/4"	3-5/8"

1 Casting

RIM CLAMPS

	EUCLID NO.	REPLACES	A	B	C	D	SPACER WIDTH
	E-5778	NWRA W-194 Gunite WP383	1-5/16"	2-5/8"	2-3/16"	3/4"	4"
	E-5782	NWRA W-195 Gunite WP384	1-3/4"	2-5/8"	2-3/16"	3/4"	3-5/8"
	EUCLID NO.	REPLACES	A	B	C	D	SPACER WIDTH
	E-5041	Ford B7Q1043A NWRA W-185 Gunite WP166	1-9/16"	2-29/32"	2-7/16"	5/8"	3-5/8"
	EUCLID NO.	REPLACES	A	B	C	D	E
	E-6053	Mack 15QJ251	1"	5/16"	2-5/8"	2-1/2"	13/16"
	EUCLID NO.	REPLACES	A	B	C	D	
	E-5780 ¹	Mack 15QJ121B Mack 15QJ121C NWRA W-122	9/16"	1-3/4"	1-13/16"	5/8"	
	EUCLID NO.	REPLACES	A	B	C	D	E
	E-6054	Navistar 452010C1	1/2"	1-1/4"	3-7/16"	2-1/16"	13/16"
	EUCLID NO.	REPLACES	A	B	C	D	SPACER WIDTH
	E-5840	Trailmobile 8-8-18 Navistar 973230R1	1-1/16"	2-13/16"	2-7/16"	3/4"	
	E-5047	Dayton-Walther 09-717510 Navistar 171194R5 Trailmobile 8-8-12 Erie E10 NWRA XW94	1-1/16"	3"	2-13/32"	5/8"	4"

RIM CLAMPS

	EUCLID NO.	REPLACES	A	B	C	D	SPACER WIDTH
		E-5046	Dayton-Walther 09-717110 Trailmobile 8-8-18 Erie E6 NWRA W-100 NWRA XW100	1-1/16"	3"	2-13/32"	3/4"

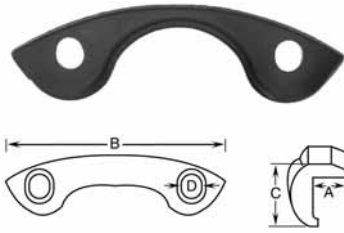
	EUCLID NO.	REPLACES	A	B	C	D	WHEEL SIZE
	E-5825	Webb 3322 NWRA W-74 NWRA XW74	1-1/16"	12-5/16"	2-5/16"	3/4"	22"
	E-5824	Webb 3320 NWRA W-72 NWRA XW72	1-1/8"	10-5/8"	2-1/2"	3/4"	20"
	E-5953	Webb 3314 NWRA W-68 NWRA XW68	1-1/4"	7-3/4"	1-13/16"	3/4"	15"
E-5973	World Truck 1109005 NWRA W-69	1-15/16"	7-11/16"	1-55/64"	3/4"	15"	

	EUCLID NO.	REPLACES	A	B	C	STUD D
		E-5976 ²	Dayton-Walther 09-007564 Webb 3350	5-3/4"	3-1/4"	2-3/8"

S.O.S.

Special Order Service

Can't find it?

Trouble sourcing products?

Need assistance?

Let Euclid's Special Order Service (S.O.S.) help you find your parts.

Euclid's position as the market leader provides you access to a comprehensive array of truck parts products from the industry's leading manufacturers. Through Euclid, these entire product lines are available to you just by placing a phone call to Euclid's S.O.S.

Department at 866-238-2543 (option 2) in the U.S. or 800-387-3889 in Canada.

² For mounting Single Wheel duplex rim in place of Dual Wheels.
Not recommended for Severe Service off-highway applications.

SPOKE WHEEL SERVICE INFORMATION

HEEL-LESS CLAMP

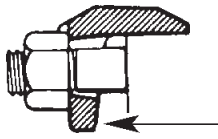

Heel-less clamps do not depend on a fulcrum at the bottom of the clamp to produce the force to wedge the rims.

Heel of clamp does not touch wheel here.

HEEL TYPE CLAMP

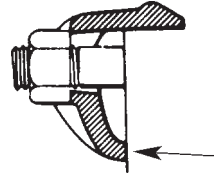

Gap permissible but not required — if gap exceeds 1/4" or if clamp bottoms out before reaching 80% of recommended torque, check to insure that proper clamps and spacer are being used.

MOUNTING INSTRUCTIONS

1. Position all Rim Clamps in place, then install the Rim Clamp Nuts finger tight. If Ball Faced Nuts are required by clamp design, be sure they are placed with the ball side to the Clamp.
2. Lightly tighten Nuts in the sequence shown to 50 foot-pounds.
3. Tighten Nuts to Wheel Manufacturer's Specifications in the Sequence shown. Tighten Nuts a quarter turn at a time.

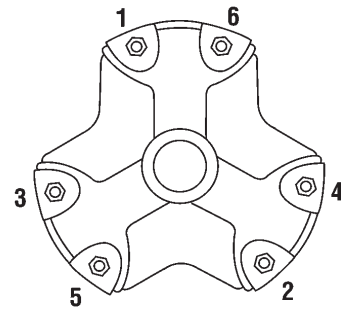
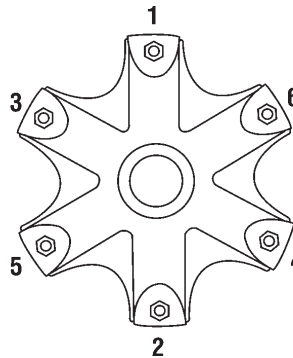
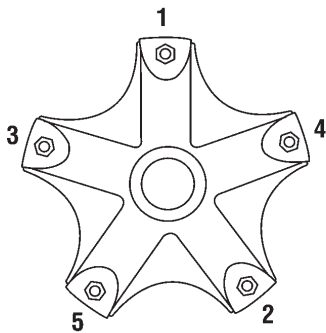

TORQUE CHART

NUT THREAD	TORQUE LEVEL
5/8" - 11	160-200 ft. lbs.(dry)
3/4" - 10	200-260 ft. lbs. (dry)

Information courtesy of TMC (The Maintenance Council of The American Trucking Association). For complete wheel service guidelines see TMC RP-222, "User's Guide to Wheels and Rims".

DISC WHEEL SERVICE INFORMATION

INSTALLATION TIPS

1. Never mix hub-piloted and stud-piloted wheels, hubs and nuts. The result could be loss of torque, a cracked wheel or possible wheel loss.
2. For nuts used on hub-piloted wheels, apply two drops of oil to a point between the nuts and flanges and two drops to the last 2 or 3 threads at the end of each stud. Also, lightly lubricate the pilots on the hub to ease wheel installation and removal. Do not get lubricant on the mounting face of the drum or wheel.
3. For nuts used on stud-piloted wheels, do not use lubrication. Never lubricate wheel or nut ball seats or mounting faces. If lubrication is used, consult the wheel manufacturer for torque recommendations.
4. Install nuts using proper installation sequence as shown below. Snug up nuts to about 50 ft.lbs. torque. Do not tighten fully until all have been seated; then torque to specs as shown below using the same installation sequence.
5. After a wheel assembly has been installed, recheck the torque level between 50 and 100 miles of operation and retighten if necessary to the recommended torque using the proper sequence.
 - a. To check and retorque an inner cap nut, it is necessary to loosen the outer cap nut first; then tighten the inner cap nut. Outer cap nuts then must be retightened to the proper level.
 - b. It is recommended that a torque check be made as part of a vehicle's scheduled maintenance program or at 10,000 mile intervals, whichever comes first.

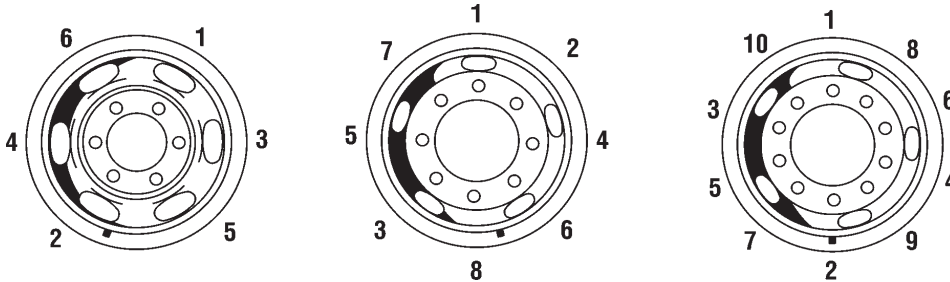

TORQUE CHART

MOUNTING TYPE	NUT THREAD	TORQUE LEVEL
Hub-piloted with flange nut	1 1/16" - 16 M20 x 1.5 M22 x 1.5	300-400 ft. lbs. (oiled)* 280-330 ft. lbs. (oiled)* 450-500 ft. lbs. (oiled)*
Stud-piloted, double cap nut - standard type (7/8" ball seat radius)	3/4" - 16 1 1/8" - 16	450-500 ft. lbs. (dry) 450-500 ft. lbs. (dry)
Stud-piloted, double cap nut - heavy-duty type (1 3/16" ball seat radius)	15/16" - 12 1 1/8" - 16 1 5/16" - 12	750-900 ft. lbs. (dry) 750-900 ft. lbs. (dry) 750-900 ft. lbs. (dry)
*See Installation Tip #2 (above)		

Information courtesy of TMC (The Maintenance Council of The American Trucking Association). For complete wheel service guidelines see TMC RP-222, "User's Guide to Wheels and Rims".

WHEEL HUB APPLICATION & STUD SELECTION CHART

EUCLID HUB NO.	O.E.M HUB NO.	AXLE APPLICATION	DISC WHEEL TYPE	DRUM MOUNT	DRUM TYPE	STUD TYPE	STUD STAND OUT	EUCLID STUD R.H.	EUCLID STUD L.H.	EUCLID INNER CAPNUT R.H.	EUCLID INNER CAPNUT L.H.	EUCLID OUTER CAPNUT R.H.	EUCLID OUTER CAPNUT L.H.
HUBS FOR STUD PILOTED WHEELS													
E-2358*	1256	Trailer	Dual Steel	Inboard	Cast	Shoulder	1.33	E-5561-R	E-5561-L	E-7895-R	E-7895-L	E-5977-R	E-5977-L
			Single Steel	Inboard	Cast	Shoulder	1.64	E-5932-R	E-5932-L	---	---	E-5652-R	E-5652-L
E-2359*	1221	Trailer	Dual Aluminum	Inboard	Cast or Fused	Shoulder	1.33	E-5561-R	E-5561-L	E-5988-R	E-5988-L	E-5977-R	E-5977-L
			Dual Steel	Inboard	Cast or Fused	Shoulder	1.33	E-5561-R	E-5561-L	E-7895-R	E-7895-L	E-5977-R	E-5977-L
			Single Steel	Inboard	Cast or Fused	Shoulder	1.64	E-5932-R	E-5932-L	---	---	E-5652-R	E-5652-L
			or Aluminum	Inboard	Cast or Fused	Shoulder	1.68	---	---	---	---	E-5977-R	E-5977-L
E-2360*	1001	Trailer	Dual Aluminum	Inboard	Cast or Fused	Shoulder	1.33	E-5561-R	E-5561-L	E-5988-R	E-5988-L	E-5977-R	E-5977-L
			Dual Steel	Inboard	Cast or Fused	Shoulder	1.33	E-5561-R	E-5561-L	E-7895-R	E-7895-L	E-5977-R	E-5977-L
			Single Steel	Inboard	Cast or Fused	Shoulder	1.68	---	---	---	---	E-5977-R	E-5977-L
			or Aluminum	Inboard	Cast or Fused	Shoulder	1.64	E-5932-R	E-5932-L	---	---	E-5652-R	E-5652-L
E-2453A*	1331	Trailer	Dual Aluminum	Inboard	Cast or Fused	Shoulder	1.34	E-5989-R	E-5989-L	E-5988-R	E-5988-L	E-5977-R	E-5977-L
			Dual Steel	Inboard	Cast or Fused	Shoulder	1.34	E-5989-R	E-5989-L	E-7895-R	E-7895-L	E-5977-R	E-5977-L
E-2665*	1051	Trailer	Dual Steel	Inboard	Cast	Shoulder	1.33	E-5561-R	E-5561-L	E-7895-R	E-7895-L	E-5977-R	E-5977-L
			Single Steel	Inboard	Cast	Shoulder	1.64	E-5932-R	E-5932-L	---	---	E-5652-R	E-5652-L
E-5107*	1020	Trailer	Dual Aluminum	Outboard	Cast	Serrated	1.36	E-8947-R	E-8947-L	E-5988-R	E-5988-L	E-5977-R	E-5977-L
				Outboard	Fused	Serrated	1.37	E-4968-R	E-4968-L	E-5988-R	E-5988-L	E-5977-R	E-5977-L
				Outboard	Fused	Serrated	1.61	E-8947-R	E-8947-L	E-5988-R	E-5988-L	E-5977-R	E-5977-L
				Outboard	Cast	Serrated	1.84	E-9008-R	E-9008-L	E-5988-R	E-5988-L	E-5977-R	E-5977-L
			Dual Steel	Outboard	Cast	Serrated	1.36	E-8947-R	E-8947-L	E-7895-R	E-7895-L	E-5977-R	E-5977-L
				Outboard	Fused	Serrated	1.37	E-4968-R	E-4968-L	E-7895-R	E-7895-L	E-5977-R	E-5977-L
			Single Steel	---	Less Drum	Serrated	1.62	E-4968-R	E-4968-L	---	---	E-5652-R	E-5652-L
			Single Steel or Aluminum	Outboard	Cast	Serrated	1.61	E-8947-R	E-8947-L	---	---	E-5652-R	E-5652-L
				Outboard	Fused	Serrated	1.84	E-9008-R	E-9008-L	---	---	E-5652-R	E-5652-L
			"Super" Single Aluminum	Outboard	Fused	Serrated	2.09	E-9008-R	E-9008-L	---	---	E-5995-R	E-5995-L
E-5108*	1056	Trailer	Dual Steel	Inboard	Cast	Shoulder	1.33	E-5561-R	E-5561-L	E-7895-R	E-7895-L	E-5977-R	E-5977-L
			Single Steel	Inboard	Cast	Shoulder	1.64	E-5932-R	E-5932-L	---	---	E-5652-R	E-5652-L
E-5115*	1521	Steering	Single Steel	Outboard	Cast	Serrated	1.36	E-5986-R	E-5986-L	---	---	E-5977-R	E-5977-L
			Single Steel or Aluminum	Outboard	Cast	Serrated	1.88	E-6033-R	E-6033-L	---	---	E-5977-R	E-5977-L
E-5116*	1530	Steering	Single Steel or Aluminum	Outboard	Cast	Serrated	1.88	E-6033-R	E-6033-L	---	---	E-5977-R	E-5977-L
E-5141*	1540	Trailer or Steering	Single Steel or Aluminum	Outboard	Cast	Serrated	1.75	E-6033-R	E-6033-L	---	---	E-5977-R	E-5977-L
E-5144*	1622	Drive	Dual Aluminum	Outboard	Cast	Serrated	1.36	E-8947-R	E-8947-L	E-5988-R	E-5988-L	E-5977-R	E-5977-L
				Outboard	Cast	Serrated	1.84	E-9008-R	E-9008-L	E-5988-R	E-5988-L	E-5977-R	E-5977-L
			Dual Steel	Outboard	Cast	Serrated	1.36	E-8947-R	E-8947-L	E-7895-R	E-7895-L	E-5977-R	E-5977-L
				Outboard	Cast	Serrated	1.84	E-9008-R	E-9008-L	---	---	E-5652-R	E-5652-L
HUBS FOR HUB PILOTED WHEELS													
04-15541	2028	Trailer	Dual 1 Steel/ 1 Aluminum	Outboard	Cast	Serrated	3.53	E-11715	---	---	---	E-6000A	---
				Outboard	X30/ CentriFuse	Serrated	2.73	E-9837	---	---	---	E-6000A	---
			Dual Aluminum	Outboard	Cast	Serrated	3.53	E-11715	---	---	---	E-6000A	---
				Outboard	X30/ CentriFuse	Serrated	3.11	E-11705	---	---	---	E-6000A	---
			Dual Steel	Outboard	X30/ CentriFuse	Serrated	2.34	E-11710	---	---	---	E-6000A	---
				Outboard	Cast	Serrated	2.48	E-9837	---	---	---	E-6000A	---
			Single Aluminum	Outboard	Cast	Serrated	2.48	E-9837	---	---	---	E-6000A	---
Single Steel	Outboard	Cast	Serrated	2.09	E-11710	---	---	---	E-6000A	---			
E-5119*	2328	Trailer	Dual 1 Steel/ 1 Aluminum	Outboard	Cast	Serrated	3.50	E-6034	---	---	---	E-5991	---
				Outboard	Fused	Serrated	2.90	E-6035	---	---	---	E-5991	---
			Dual Aluminum	Outboard	Cast	Serrated	3.50	E-6034	---	---	---	E-5991	---
				Outboard	Fused	Serrated	3.28	---	---	---	---	E-5991	---
			Dual Steel	Outboard	Fused	Serrated	2.90	E-6035	---	---	---	E-5991	---
				Outboard	Cast	Serrated	2.65	E-6035	---	---	---	E-5991	---
			Single Aluminum	Outboard	Cast	Serrated	2.65	E-6035	---	---	---	E-5991	---
Single Steel	Outboard	Cast	Serrated	2.21	E-6036	---	---	---	E-5991	---			
Single Steel or Aluminum	Outboard	Fused	Serrated	2.46	E-6036	---	---	---	E-5991	---			

* Hub No Longer Available

(continued on next page)

4

WHEEL HUB APPLICATION & STUD SELECTION CHART

EUCLID HUB NO.	O.E.M HUB NO.	AXLE APPLICATION	DISC WHEEL TYPE	DRUM MOUNT	DRUM TYPE	STUD TYPE	STUD STAND OUT	EUCLID STUD R.H.	EUCLID STUD L.H.	EUCLID INNER CAP NUT R.H.	EUCLID INNER CAP NUT L.H.	EUCLID OUTER CAP NUT R.H.	EUCLID OUTER CAP NUT L.H.
UNIVERSAL HUBS FOR STUD PILOTTED WHEELS													
04-15501 04-15984		Trailer	Dual Steel	Outboard	Cast	Serrated	1.38	E-11672-R	E-11672-L	E-7895-R	E-7895-L	E-5977-R	E-5977-L
			Dual Aluminum	Outboard	Cast	Serrated	1.80	E-11677-R	E-11677-L	E-5988-R	E-5988-L	E-5977-R	E-5977-L
			Dual Steel	Outboard	X-30 / CentriFuse	Serrated	1.38	E-11661-R	E-11661-L	E-7895-R	E-7895-L	E-5977-R	E-5977-L
			Dual Aluminum	Outboard	X-30 / CentriFuse	Serrated	1.63	E-11676-R	E-11676-L	E-5988-R	E-5988-L	E-5977-R	E-5977-L
			Single Steel	Outboard	Cast	Serrated	1.80	E-11677-R	E-11677-L	—	—	E-5652-R	E-5652-L
			Single Aluminum	Outboard	Cast	Serrated	1.80	E-11677-R	E-11677-L	—	—	E-5652-R	E-5652-L
			Single Steel	Outboard	X-30 / CentriFuse	Serrated	1.63	E-11676-R	E-11676-L	—	—	E-5652-R	E-5652-L
			Single Aluminum	Outboard	X-30 / CentriFuse	Serrated	1.63	E-11676-R	E-11676-L	—	—	E-5652-R	E-5652-L
Super Single Al.	Outboard	X-30 / CentriFuse	Serrated	2.05	E-11677-R	E-11677-L	—	—	E-5652-R	E-5652-L			
04-15502 04-15675		Trailer	Dual Steel	Outboard	Cast	Serrated	1.38	E-11672-R	E-11672-L	E-7895-R	E-7895-L	E-5977-R	E-5977-L
			Dual Aluminum	Outboard	Cast	Serrated	1.80	E-11677-R	E-11677-L	E-5988-R	E-5988-L	E-5977-R	E-5977-L
			Dual Steel	Outboard	X-30 / CentriFuse	Serrated	1.38	E-11661-R	E-11661-L	E-7895-R	E-7895-L	E-5977-R	E-5977-L
			Dual Aluminum	Outboard	X-30 / CentriFuse	Serrated	1.63	E-11676-R	E-11676-L	E-5988-R	E-5988-L	E-5977-R	E-5977-L
			Single Steel	Outboard	Cast	Serrated	1.80	E-11677-R	E-11677-L	—	—	E-5652-R	E-5652-L
			Single Aluminum	Outboard	Cast	Serrated	1.80	E-11677-R	E-11677-L	—	—	E-5652-R	E-5652-L
			Single Steel	Outboard	X-30 / CentriFuse	Serrated	1.63	E-11676-R	E-11676-L	—	—	E-5652-R	E-5652-L
			Single Aluminum	Outboard	X-30 / CentriFuse	Serrated	1.63	E-11676-R	E-11676-L	—	—	E-5652-R	E-5652-L
Super Single Al.	Outboard	X-30 / CentriFuse	Serrated	2.05	E-11677-R	E-11677-L	—	—	E-5652-R	E-5652-L			
E-9347*	2623	Drive	Dual Steel	Outboard	Cast	Serrated	1.38	E-9010-R	E-9010-L	E-7895-R	E-7895-L	E-5977-R	E-5977-L
			Dual Aluminum	Outboard	Cast	Serrated	1.38	E-9010-R	E-9010-L	E-5988-R	E-5988-L	E-5977-R	E-5977-L
				Outboard	Cast	Serrated	1.74	E-9524-R	E-9524-L	E-5988-R	E-5988-L	E-5977-R	E-5977-L
			Dual Steel	Outboard	Fused	Serrated	1.38	E-9523-R	E-9523-L	E-7895-R	E-7895-L	E-5977-R	E-5977-L
			Dual Aluminum	Outboard	Fused	Serrated	1.38	E-9523-R	E-9523-L	E-5988-R	E-5988-L	E-5977-R	E-5977-L
				Outboard	Fused	Serrated	1.63	E-9010-R	E-9010-L	E-5988-R	E-5988-L	E-5977-R	E-5977-L
			Single Steel	Outboard	Cast	Serrated	1.74	E-9524-R	E-9524-L	—	—	E-5652-R	E-5652-L
			Single Aluminum	Outboard	Cast	Serrated	1.74	E-9524-R	E-9524-L	—	—	E-5652-R	E-5652-L
			Single Steel	Outboard	Fused	Serrated	1.63	E-9010-R	E-9010-L	—	—	E-5652-R	E-5652-L
			Single Aluminum	Outboard	Fused	Serrated	1.63	E-9010-R	E-9010-L	—	—	E-5652-R	E-5652-L
Super Single Al.	Outboard	Fused	Serrated	1.99	E-9524-R	E-9524-L	—	—	E-5652-R	E-5652-L			
E-9348*	2023	Trailer	Dual Steel	Outboard	Cast	Serrated	1.38	E-9010-R	E-9010-L	E-7895-R	E-7895-L	E-5977-R	E-5977-L
			Dual Aluminum	Outboard	Cast	Serrated	1.38	E-9010-R	E-9010-L	E-5988-R	E-5988-L	E-5977-R	E-5977-L
				Outboard	Cast	Serrated	1.74	E-9524-R	E-9524-L	E-5988-R	E-5988-L	E-5977-R	E-5977-L
			Dual Steel	Outboard	Fused	Serrated	1.38	E-9523-R	E-9523-L	E-7895-R	E-7895-L	E-5977-R	E-5977-L
			Dual Aluminum	Outboard	Fused	Serrated	1.38	E-9523-R	E-9523-L	E-5988-R	E-5988-L	E-5977-R	E-5977-L
				Outboard	Fused	Serrated	1.63	E-9010-R	E-9010-L	E-5988-R	E-5988-L	E-5977-R	E-5977-L
			Single Steel	Outboard	Cast	Serrated	1.74	E-9524-R	E-9524-L	—	—	E-5652-R	E-5652-L
			Single Aluminum	Outboard	Cast	Serrated	1.74	E-9524-R	E-9524-L	—	—	E-5652-R	E-5652-L
			Single Steel	Outboard	Fused	Serrated	1.63	E-9010-R	E-9010-L	—	—	E-5652-R	E-5652-L
			Single Aluminum	Outboard	Fused	Serrated	1.63	E-9010-R	E-9010-L	—	—	E-5652-R	E-5652-L
Super Single Al.	Outboard	Fused	Serrated	1.99	E-9524-R	E-9524-L	—	—	E-5652-R	E-5652-L			
E-9349*	2323	Trailer	Dual Steel	Outboard	Cast	Serrated	1.38	E-9010-R	E-9010-L	E-7895-R	E-7895-L	E-5977-R	E-5977-L
			Dual Aluminum	Outboard	Cast	Serrated	1.38	E-9010-R	E-9010-L	E-5988-R	E-5988-L	E-5977-R	E-5977-L
				Outboard	Cast	Serrated	1.74	E-9524-R	E-9524-L	E-5988-R	E-5988-L	E-5977-R	E-5977-L
			Dual Steel	Outboard	Fused	Serrated	1.38	E-9523-R	E-9523-L	E-7895-R	E-7895-L	E-5977-R	E-5977-L
			Dual Aluminum	Outboard	Fused	Serrated	1.38	E-9523-R	E-9523-L	E-5988-R	E-5988-L	E-5977-R	E-5977-L
				Outboard	Fused	Serrated	1.63	E-9010-R	E-9010-L	E-5988-R	E-5988-L	E-5977-R	E-5977-L
			Single Steel	Outboard	Cast	Serrated	1.74	E-9524-R	E-9524-L	—	—	E-5652-R	E-5652-L
			Single Aluminum	Outboard	Cast	Serrated	1.74	E-9524-R	E-9524-L	—	—	E-5652-R	E-5652-L
			Single Steel	Outboard	Fused	Serrated	1.63	E-9010-R	E-9010-L	—	—	E-5652-R	E-5652-L
			Single Aluminum	Outboard	Fused	Serrated	1.63	E-9010-R	E-9010-L	—	—	E-5652-R	E-5652-L
Super Single Al.	Outboard	Fused	Serrated	1.99	E-9524-R	E-9524-L	—	—	E-5652-R	E-5652-L			

* Hub No Longer Available

WHEEL HUB APPLICATION & STUD SELECTION CHART

EUCLID HUB NO.	O.E.M HUB NO.	AXLE APPLICATION	DISC WHEEL TYPE	DRUM MOUNT	DRUM TYPE	STUD TYPE	STUD STAND OUT	EUCLID STUD R.H.	EUCLID STUD L.H.	EUCLID INNER CAP NUT R.H.	EUCLID INNER CAP NUT L.H.	EUCLID OUTER CAP NUT R.H.	EUCLID OUTER CAP NUT L.H.	
UNIVERSAL HUBS FOR HUB PILOTTED WHEELS														
04-15501 04-15984		Trailer	Dual Steel	Outboard	Cast	Serrated	2.48	E-9837	—	—	—	—	E-6000A	—
			Dual Aluminum	Outboard	Cast	Serrated	3.53	E-11715	—	—	—	—	E-6000A	—
			Dual Steel/Alum.	Outboard	Cast	Serrated	3.53	E-11715	—	—	—	—	E-6000A	—
			Dual Steel	Outboard	X-30 / CentriFuse	Serrated	2.34	E-11710	—	—	—	—	E-6000A	—
			Dual Aluminum	Outboard	X-30 / CentriFuse	Serrated	3.11	E-11705	—	—	—	—	E-10235	—
			Dual Steel/Alum.	Outboard	X-30 / CentriFuse	Serrated	2.73	E-9837	—	—	—	—	E-6000A	—
			Single Steel	Outboard	Cast	Serrated	2.09	E-11710	—	—	—	—	E-6000A	—
			Single Aluminum	Outboard	Cast	Serrated	2.48	E-9837	—	—	—	—	E-6000A	—
			Single Steel	Outboard	X-30 / CentriFuse	Serrated	2.34	E-11710	—	—	—	—	E-6000A	—
			Single Aluminum	Outboard	X-30 / CentriFuse	Serrated	2.34	E-11710	—	—	—	—	E-6000A	—
Super Single Al.	Outboard	X-30 / CentriFuse	Serrated	2.73	E-9837	—	—	—	—	E-6000A	—			
04-15502 04-15675		Trailer	Dual Steel	Outboard	Cast	Serrated	2.48	E-9837	—	—	—	—	E-6000A	—
			Dual Aluminum	Outboard	Cast	Serrated	3.53	E-11715	—	—	—	—	E-6000A	—
			Dual Steel/Alum.	Outboard	Cast	Serrated	3.53	E-11715	—	—	—	—	E-6000A	—
			Dual Steel	Outboard	X-30 / CentriFuse	Serrated	2.28	E-11710	—	—	—	—	E-6000A	—
			Dual Aluminum	Outboard	X-30 / CentriFuse	Serrated	3.11	E-11705	—	—	—	—	E-10235	—
			Dual Steel/Alum.	Outboard	X-30 / CentriFuse	Serrated	2.73	E-9837	—	—	—	—	E-6000A	—
			Single Steel	Outboard	Cast	Serrated	2.09	E-11710	—	—	—	—	E-6000A	—
			Single Aluminum	Outboard	Cast	Serrated	2.48	E-9837	—	—	—	—	E-6000A	—
			Single Steel	Outboard	X-30 / CentriFuse	Serrated	2.34	E-11710	—	—	—	—	E-6000A	—
			Single Aluminum	Outboard	X-30 / CentriFuse	Serrated	2.34	E-11710	—	—	—	—	E-6000A	—
Super Single Al.	Outboard	X-30 / CentriFuse	Serrated	2.73	E-9837	—	—	—	—	E-6000A	—			
E-9348*	2023	Trailer	Dual Steel	Outboard	Cast	Serrated	2.47	E-6035	—	—	—	—	E-6000A	—
			Dual Aluminum	Outboard	Cast	Serrated	3.32	E-6034	—	—	—	—	E-6000A	—
			Dual Steel/Alum.	Outboard	Cast	Serrated	3.32	E-6034	—	—	—	—	E-6000A	—
			Dual Steel	Outboard	Fused	Serrated	2.28	E-6036	—	—	—	—	E-6000A	—
			Dual Aluminum	Outboard	Fused	Serrated	3.10	E-9526	—	—	—	—	E-6000A	—
			Dual Steel/Alum.	Outboard	Fused	Serrated	2.72	E-6035	—	—	—	—	E-6000A	—
			Single Steel	Outboard	Cast	Serrated	2.03	E-6036	—	—	—	—	E-6000A	—
			Single Aluminum	Outboard	Cast	Serrated	2.47	E-6035	—	—	—	—	E-6000A	—
			Single Steel	Outboard	Fused	Serrated	2.28	E-6036	—	—	—	—	E-6000A	—
			Single Aluminum	Outboard	Fused	Serrated	2.28	E-6036	—	—	—	—	E-6000A	—
Super Single Al.	Outboard	Fused	Serrated	2.72	E-6035	—	—	—	—	E-6000A	—			
E-9349*	2323	Trailer	Dual Steel	Outboard	Cast	Serrated	2.47	E-6035	—	—	—	—	E-6000A	—
			Dual Aluminum	Outboard	Cast	Serrated	3.32	E-6034	—	—	—	—	E-6000A	—
			Dual Steel/Alum.	Outboard	Cast	Serrated	3.32	E-6034	—	—	—	—	E-6000A	—
			Dual Steel	Outboard	Fused	Serrated	2.28	E-6036	—	—	—	—	E-6000A	—
			Dual Aluminum	Outboard	Fused	Serrated	3.10	E-9526	—	—	—	—	E-6000A	—
			Dual Steel/Alum.	Outboard	Fused	Serrated	2.72	E-6035	—	—	—	—	E-6000A	—
			Single Steel	Outboard	Cast	Serrated	2.03	E-6036	—	—	—	—	E-6000A	—
			Single Aluminum	Outboard	Cast	Serrated	2.47	E-6035	—	—	—	—	E-6000A	—
			Single Steel	Outboard	Fused	Serrated	2.28	E-6036	—	—	—	—	E-6000A	—
			Single Aluminum	Outboard	Fused	Serrated	2.28	E-6036	—	—	—	—	E-6000A	—
Super Single Al.	Outboard	Fused	Serrated	2.72	E-6035	—	—	—	—	E-6000A	—			

4

* Hub No Longer Available

SPOKE TRAILER WHEELS

FOR AXLE MODELS

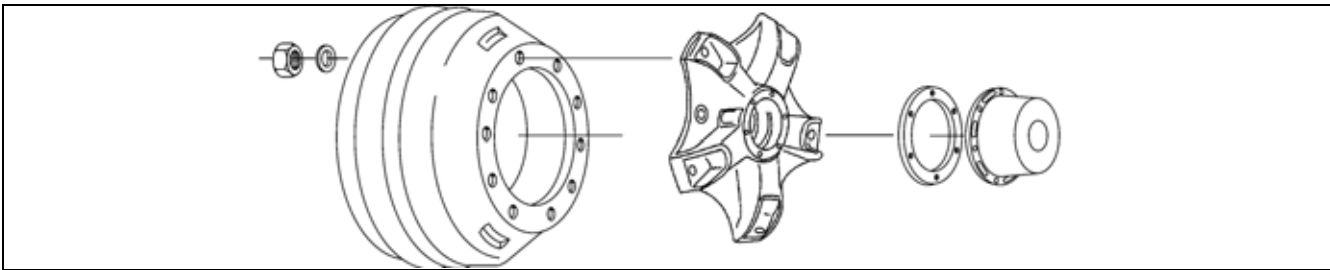

DANA P-22
 EATON 225P, 230P
 FRUEHAUF PRO-PAR
 INGERSOLL A24S, A24H, F24
 MERITOR TP



	EUCLID NO.	REPLACES	TYPE	INNER BEARING		OUTER BEARING	
				CUP	CONE	CUP	CONE
	47-09715-002	Paccar 47-09715 Strick 47-09715-002 Erie 9080 Erie 9080-20 Trailmobile DW-47-09715-002 Gunite TA454K Gunite TX802K	5 Spoke 20"	HM518410	HM518445	HM518410	HM518445



FOR AXLE MODELS

DANA D-22, K-22
 DEXTER D200K, D225K
 EATON 225D, 225J, 23L, 23R, 25R, HJ, HJE, HR25, J, JE, JH
 INGERSOLL A22H, A22S, A22T, DC22H, F22, K-B, KBW-KBS
 MERITOR RN, RQ, TKN, TN, TQ, TOC, TOD
 STANDARD FORGE A22H, A22S, A22T
 WESTPORT F3W-1600, F3W-1800, F6W-1600

	EUCLID NO.	REPLACES	TYPE	INNER BEARING		OUTER BEARING	
				CUP	CONE	CUP	CONE
	47-14018-007	Paccar 47-14018-007 Webb 7520 Erie 904 Erie 904-20 Trailmobile DW-47-14018-007 Gunite TX877K	5 Spoke 20"	HM218210	HM218248	HM212011	HM212049
	47-14068-007	Volvo 3099692 Paccar 4714068007 Erie 920 Erie 920-20 Trailmobile DW-47-14068-007 Freightliner TDA-4714068007 Gunite TY746K	5 Spoke 22"	HM218210	HM218248	HM212011	HM212049

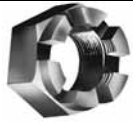

TRAILER AXLE SPINDLE HARDWARE

EATON & FRUEHAUF AXLES



	EUCLID NO.	DESCRIPTION	REPLACES	ACROSS FLATS	THREAD SIZE	THICK	WASHERS		PIN	
							O.D.	I.D.	DIA.	LENGTH
	E-2306	Cotter Pin	Fruehauf 103426 Dana/Spicer 12-406						1/4"	3"
	E-620	Axle Spindle Washer	Fruehauf 530085			1/4"	3"	1-1/2" x 1-3/8" "D" Hole		
	E-576	Axle Spindle Nut	Fruehauf 530088 Eaton X-115	2-3/16"	1-1/2"-12	1-1/2"				

4

EATON, MERITOR, SPICER & STD. FORGE 13,000 & 14,000 LB. AXLES





	EUCLID NO.	DESCRIPTION	REPLACES	ACROSS FLATS	THREAD SIZE	THICKNESS	WASHERS	
							O.D.	I.D.
	E-617	Axle Spindle Lock Washer	Meritor 1229G709 Trailmobile 6-5-1 Dana/Spicer M10HN105			1/16"	3"	1-3/4" x 1-5/8" "D" Hole
	E-619	Axle Thrust Washer	Meritor 1229F708 Trailmobile 6-6-6 Dana/Spicer M10HN104			1/8"	3"	1-3/4" x 1-5/8" "D" Hole
	E-618	Axle Spindle Nut	Meritor 1227H34 Trailmobile 37775 Trailmobile 6-3-3 Dana/Spicer M10HN107	2-1/2"	1-3/4"-12	3/8"		

FRUEHAUF "PRO-PAR" AXLE AND MERITOR EARLY MODEL TP AXLE



	EUCLID NO.	DESCRIPTION	REPLACES	ACROSS FLATS	THREAD SIZE	THICK	WASHERS		PIN	
							O.D.	I.D.	DIA.	LENGTH
	E-1559	Cotter Pin	Eaton 4-2204 Eaton 42204 Trailmobile 700-7-215 Holland Hitch A-XA0409-1 Fruehauf AXA-000409-001 Fruehauf AXA-04091						1/4"	1"
	E-1561	Axle Spindle Washer	Eaton 4-2203 Eaton 42203 Trailmobile 700-7-15 Holland Hitch A-XA0408-1 Fruehauf AXA-000408-001 Fruehauf AXA-04081			7/32"	5-1/16"	3-1/2"		
	E-2550	Axle Spindle Nut	Eaton 4-2202 Eaton 42202 Trailmobile 700-7-14 Holland Hitch A-CE8510-1 Fruehauf ACE-008510-001 Fruehauf ACE-85101	4-3/4"	3-1/2"-12	1-1/8"				

TRAILER AXLE SPINDLE HARDWARE

MERITOR RL, RN, RQ, TK, TKL, TKN AXLES - "POSITIVE" ADJUSTMENT

	EUCLID NO.	DESCRIPTION	REPLACES	ACROSS FLATS	THREAD SIZE	THICKNESS	WASHERS	
							O.D.	I.D.
	E-3010	Axle Spindle Lock Washer				1/16"	4"	2-13/32"
	E-1252	Axle Spindle Lock Washer	Meritor 1229T1996 Eaton 4-2199 Eaton 42199 Trailmobile 700-7-18			3/8"	3-13/16"	2-13/32"
	E-1251	Outer Axle Spindle Nut	Meritor 1227Z676 Eaton 4-2198 Eaton 42198 Trailmobile 700-7-16	3-1/4"	2-3/8"16	3/8"		
	E-1253	Inner Axle Spindle Nut	Meritor 1227B678 Eaton 4-2201 Eaton 42201	3-13/16"	2-3/8"16	1/2"		
	E-2128 ¹	Replacement Service Nut	Meritor 1227S877 Dana/Spicer 12399 Eaton 4-2200 Eaton 42200 Trailmobile 700-7-17 Meritor A1227S877	3-13/16"	2-3/8"16	1/2"		

MERITOR TN, TQ AXLES - "MANUAL" ADJUSTMENT





	EUCLID NO.	DESCRIPTION	REPLACES	ACROSS FLATS	THREAD SIZE	THICKNESS	WASHERS	
							O.D.	I.D.
	E-3008 ²	Lock Washer	Meritor A1229W2545			1/4"	3-7/8"	2-41/64"
	E-572	Outer Axle Spindle Nut	Dana/Spicer 10286 Dana/Spicer 10408 Meritor 1227B756 Eaton 4-2194 Eaton 42194 Trailmobile 700-7-13 Eaton 820395 Dana/Spicer M10HN102	3-1/4"	2-5/8"-16	3/8"		
	E-540	Inner Axle Spindle Nut	Dana/Spicer 10284 Meritor 1227C549 GMC 2408341 Eaton 4-2196 Eaton 42196 Trailmobile 700-7-11 Eaton 820394 Navistar 870813R1 Dana/Spicer M10HN101	3-13/16"	2-5/8"-16	3/8"		

¹ Used in place of E-1253 to convert to "manual" adjustment.

² Includes E-10793 set screw.



TRAILER AXLE SPINDLE HARDWARE

MERITOR TN, TQ AXLES - "POSITIVE" ADJUSTMENT

	EUCLID NO.	DESCRIPTION	REPLACES	ACROSS FLATS	THREAD SIZE	THICKNESS	WASHERS	
							O.D.	I.D.
	E-7663	Axle Spindle Lock Washer	Meritor A1229X2546			15/64"	3-7/8"	2-25/64"
	E-1251	Outer Axle Spindle Nut	Meritor 1227Z676 Eaton 4-2198 Eaton 42198 Trailmobile 700-7-16	3-1/4"	2-3/8"-16	3/8"		
	E-1253	Inner Axle Spindle Nut	Meritor 1227B678 Eaton 4-2201 Eaton 42201	3-13/16"	2-3/8"-16	1/2"		
	E-2128 ¹	Replacement Service Nut	Meritor 1227S877 Dana/Spicer 12399 Eaton 4-2200 Eaton 42200 Trailmobile 700-7-17 Meritor A1227S877	3-13/16"	2-3/8"-16	1/2"		

4

MERITOR TP AXLE - "MANUAL" ADJUSTMENT

	EUCLID NO.	DESCRIPTION	REPLACES	ACROSS FLATS	THREAD SIZE	THICKNESS	WASHERS	
							O.D.	I.D.
	E-7665 ²	Axle Spindle Lock Washer	Meritor 1229H4584			7/32"	5-1/16"	3-1/2"
	E-7666	Outer Axle Spindle Nut	Meritor 1227B1484	4-3/8"	3-1/2"-12	3/8"		
	E-7664	Inner Axle Spindle Nut	Meritor 1227K1389	4-27/32"	3-1/2"-12	3/8"		









an **ArvinMeritor**™ brand

¹ Used in place of E-1253 to convert to "manual" adjustment.
⁵ Use in place of E-7659 to convert to manual adjustment.



² Includes E-10793 set screw.

TRAILER AXLE SPINDLE HARDWARE

MERITOR TP AXLE - "POSITIVE" ADJUSTMENT

	EUCLID NO.	DESCRIPTION	REPLACES	ACROSS FLATS	THREAD SIZE	THICKNESS	O.D.	I.D.
		E-7660 ²	Axle Spindle Lock Washer	Meritor 1229S4179			15/64"	4-3/4"
	E-7659	Axle Spindle Lock Washer	Meritor 1229Y3119			9/32"	5"	3-9/32"
	E-7662 ⁵	Axle Spindle Lock Washer	Meritor 1229B3122			9/32"	5"	3-9/32"
	E-2303	Inner Axle Spindle Nut	Eaton 119883 Meritor 1227W517 Mack 25QJ-35 Eaton 4-2222 Eaton 42222 Meritor A1227S331	4"	3-1/4"-12	3/8"		
	E-2305	Outer Axle Spindle Nut	Eaton 119881 Meritor 1227R330 Mack 25QJ-36 Eaton 4-2223 Eaton 42223	4"	3-1/4"-12	3/8"		
	E-7658 ⁴	Inner Axle Spindle Nut	Meritor 1227R1240	4"	3-1/4"-12	3/8"		





MERITOR TR AXLE

	EUCLID NO.	DESCRIPTION	REPLACES	ACROSS FLATS	THREAD SIZE	THICKNESS	WASHERS	
							O.D.	I.D.
	E-7660 ²	Axle Spindle Lock Washer	Meritor 1229S4179			15/64"	4-3/4"	3-5/16"
	E-2303	Inner Axle Spindle Nut	Eaton 119883 Meritor 1227W517 Mack 25QJ-35 Eaton 4-2222 Eaton 42222 Meritor A1227S331	4"	3-1/4"-12	3/8"		
	E-2305	Outer Axle Spindle Nut	Eaton 119881 Meritor 1227R330 Mack 25QJ-36 Eaton 4-2223 Eaton 42223	4"	3-1/4"-12	3/8"		

² Includes E-10793 set screw.



TRAILER AXLE SPINDLE HARDWARE

MERITOR, EATON, KERSHAW & STD. FORGE 17,000 & 18,000 LB. TRADE AXLES

	EUCLID NO.	DESCRIPTION	REPLACES	ACROSS FLATS	THREAD SIZE	THICK	WASHERS		TAB LENGTH
							O.D.	I.D.	
	E-3009	Axle Spindle Lock Washer				1/16"	4-1/32"	2-41/64"	3/32"
	E-2237	Axle Spindle Lock Washer	Eaton 4-2197 Eaton 42197 Dana/Spicer M10HN151			1/16"	4-1/32"	2-41/64"	5/32"
	E-573 ³	Axle Spindle Lock Washer	Dana/Spicer 10287 Meritor 1229V1660 Meritor 1229W2545 Eaton 4-2195 Trailmobile 700-7-12 Ford 7EQ1124 Ford 7EQ1124A Eaton 820396 Hendrickson Turner A-1987 Meritor A1229W2545 Dana/Spicer M10HN100			1/4"	3-15/16"	2-41/64"	
	E-572	Outer Axle Spindle Nut	Dana/Spicer 10286 Dana/Spicer 10408 Meritor 1227B756 Eaton 4-2194 Trailmobile 700-7-13 Eaton 820395 Dana/Spicer M10HN102	3-1/4"	2-5/8"-16	3/8"			
	E-540	Inner Axle Spindle Nut	Dana/Spicer 10284 Meritor 1227C549 GMC 2408341 Eaton 4-2196 Trailmobile 700-7-11 Eaton 820394 Navistar 870813R1 Dana/Spicer M10HN101	3-13/16"	2-5/8"-16	3/8"			

4





MERITOR, SPICER & STD. FORGE 11,000 LB. AXLES

	EUCLID NO.	DESCRIPTION	REPLACES	ACROSS FLATS	THREAD SIZE	THICKNESS	WASHERS	
							O.D.	I.D.
	E-1000	Axle Spindle Lock Washer	Meritor 1229T462 Trailmobile 6-5-9 Dana/Spicer M10HN130			1/16"	2-7/8"	1-1/2" x 1-3/8" "D" Hole
	E-1001	Axle Thrust Washer	Meritor 1229J712 Trailmobile 6-6-2 Dana/Spicer M10HN129			1/8"	2-1/4"	1-1/2" x 1-3/8" "D" Hole
	E-1087	Spindle Nut	Dana/Spicer 12-458 Meritor 1227X102 Trailmobile 38506 Trailmobile 6-3-5 Dana/Spicer M10HN128	2-1/4"	1-1/2"-12	9/32"		

³ Used with all Standard Depth Axle Keyway (long hub).

TRAILER AXLE SPINDLE HARDWARE



SPICER D21 & D22 AND STD. FORGE A25 & A26 AXLES

	EUCLID NO.	DESCRIPTION	REPLACES	ACROSS FLATS	THREAD SIZE	THICK	WASHERS	
							O.D.	I.D.
	E-2237	Axle Spindle Lock Washer	Eaton 4-2197 Eaton 42197 Dana/Spicer M10HN151			1/16"	4-1/32"	2-41/64"
	E-573 ³	Axle Spindle Lock Washer	Dana/Spicer 10287 Meritor 1229V1660 Meritor 1229W2545 Eaton 4-2195 Trailmobile 700-7-12 Ford 7EQ1124 Ford 7EQ1124A Eaton 820396 Hendrickson Turner A-1987 Meritor A1229W2545 Dana/Spicer M10HN100			1/4"	3-15/16"	2-41/64"
	E-572	Outer Axle Spindle Nut	Dana/Spicer 10286 Dana/Spicer 10408 Meritor 1227B756 Eaton 4-2194 Trailmobile 700-7-13 Eaton 820395 Dana/Spicer M10HN102	3-1/4"	2-5/8"-16	3/8"		
	E-540	Inner Axle Spindle Nut	Dana/Spicer 10284 Meritor 1227C549 GMC 2408341 Eaton 4-2196 Trailmobile 700-7-11 Eaton 820394 Navistar 870813R1 Dana/Spicer M10HN101	3-13/16"	2-5/8"-16	3/8"		

STEERING AXLE SPINDLE HARDWARE

For Light, Medium, and Heavy-Duty Trucks

CHEVROLET & GMC F050, F055

	EUCLID NO.	DESCRIPTION	REPLACES	ACROSS FLATS	THREAD SIZE	THICKNESS	WASHERS	
							O.D.	I.D.
	E-4874	Thrust Washer	GMC 3702236			9/64"	2-1/2"	7/8"
	E-4849	Axle Spindle Nut	GMC 379656	1-1/4"	7/8"-20	13/16"		

³ Used with all Standard Depth Axle Keyway (long hub).



STEERING AXLE SPINDLE HARDWARE

For Light, Medium, and Heavy-Duty Trucks

CHEVROLET & GMC F070

	EUCLID NO.	DESCRIPTION	REPLACES	ACROSS FLATS	THREAD SIZE	THICKNESS	WASHERS	
							O.D.	I.D.
	E-4854	Axle Spindle Nut	GMC 3762598	1-5/8"	1-1/8"-16	3/4"		



CHEVROLET & GMC G30, P30, G3500

	EUCLID NO.	DESCRIPTION	REPLACES	ACROSS FLATS	THREAD SIZE	THICKNESS	WASHERS	
							O.D.	I.D.
	E-4879	Thrust Washer	GMC 3936464			1/8"	2-1/4"	7/8"
	E-4865	Axle Spindle Nut	GMC 3953436	1-1/4"	27/32"-20	9/16"		



FORD 5,000 LB. FRONT AXLE

	EUCLID NO.	DESCRIPTION	REPLACES	ACROSS FLATS	THREAD SIZE	THICKNESS	WASHERS	
							O.D.	I.D.
	E-4859	Axle Spindle Nut	Ford 351163S	1-7/16"	1"-14	5/8"		

FORD 6,000 LB. FRONT AXLE

	EUCLID NO.	DESCRIPTION	REPLACES	ACROSS FLATS	THREAD SIZE	THICKNESS	WASHERS	
							O.D.	I.D.
	E-4869	Thrust Washer	Ford D5HZ1195C			3/16"	3"	1-1/2"
	E-4861	Axle Spindle Nut	Ford D5HZ3104A	2-1/4"	1-1/2"-18	7/8"		



MACK FRONT AXLES

	EUCLID NO.	DESCRIPTION	REPLACES	ACROSS FLATS	THREAD SIZE	THICKNESS	WASHERS	
							O.D.	I.D.
	E-3502	Axle Thrust Washer	Mack 35AX1415			1/8"	3"	
	E-3501	Axle Spindle Nut	Mack 21AX790	2-5/8"	1-5/8"-12	3/8"		



STEERING AXLE SPINDLE HARDWARE

For Light, Medium, and Heavy-Duty Trucks



NAVISTAR 02109 (DANA FA109) 9,000 LBS.
 NAVISTAR 02139 (DANA FA139) 12,000 LBS.
 NAVISTAR 02309 (DANA I-90) 9,000 LBS.
 NAVISTAR 02329 (DANA I-108) 10,800 LBS.

	EUCLID NO.	DESCRIPTION	REPLACES	ACROSS FLATS	THREAD SIZE	THICKNESS	WASHERS	
							O.D.	I.D.
	E-4871	Lock Washer	Trailmobile 38-4871 Navistar 470421-C1			3/32"	3-7/16"	2-3/32"
	E-6138	Thrust Washer	Navistar 451941C1			1/4"	3-3/4"	2-3/32"
	E-4855	Axle Spindle Nut	Navistar 50325-R1	2-7/8"	2-1/16"-16	3/8"		

NAVISTAR 02109 (DANA FA109) 9,000 LBS.
 NAVISTAR 02139 (DANA FA139) 12,000 LBS.
 NAVISTAR 02309 (DANA I-90) 9,000 LBS.
 NAVISTAR 02329 (DANA I-108) 10,800 LBS.

	EUCLID NO.	DESCRIPTION	RELACES	ACROSS FLATS	THREAD SIZE	THICKNESS	WASHERS	
							O.D.	I.D.
	E-4871	Lock Washer	Trailmobile 38-4871 Navistar 470421-C1			3/32"	3-7/16"	2-3/32"
	E-6139	Thrust Washer	Navistar 484188-C1			1/4"	4-1/8"	2-3/32"
	E-4855	Axle Spindle Nut	Navistar 50325-R1	2-7/8"	2-1/16"-16	3/8"		

NAVISTAR FA48

	EUCLID NO.	DESCRIPTION	REPLACES	ACROSS FLATS	THREAD SIZE	THICKNESS	WASHERS	
							O.D.	I.D.
	E-4875	Thrust Washer	Navistar 97788-H			13/64"	2-1/8"	1"
	E-4850	Axle Spindle Nut	Navistar 427646	1-1/4"	7/8"-14	3/4"		



STEERING AXLE SPINDLE HARDWARE

For Light, Medium, and Heavy-Duty Trucks



NAVISTAR FA68, FA72

	EUCLID NO.	DESCRIPTION	REPLACES	ACROSS FLATS	THREAD SIZE	THICKNESS	WASHERS	
							O.D.	I.D.
	E-4851	Axle Spindle Nut	Navistar 27197-H	1-1/2"	1"-14	7/8"		





NAVISTAR FA70, FA89, FA91, FA98

	EUCLID NO.	DESCRIPTION	REPLACES	ACROSS FLATS	THREAD SIZE	THICKNESS	WASHERS	
							O.D.	I.D.
	E-4868	Thrust Washer	Navistar 50764-V			5/32"	2-5/8"	1-1/8"
	E-4853	Axle Spindle Nut	Navistar 51207-V	1-5/8"	1-1/8"-12	3/4"		

NAVISTAR FA71, FA73, FA101

	EUCLID NO.	DESCRIPTION	REPLACES	ACROSS FLATS	THREAD SIZE	THICKNESS	WASHERS	
							O.D.	I.D.
	E-4870	Lock Washer	Navistar 441255-C1			3/4"	2-1/32"	1-1/8"
	E-4852	Axle Spindle Nut	Navistar 441256-C1	1-5/8"	1-1/8"-12	1/2"		



MERITOR FD-900, FD-901, FE-900, FF-901, FF931 AXLES

	EUCLID NO.	DESCRIPTION	REPLACES	ACROSS FLATS	THREAD SIZE	THICKNESS	WASHERS	
							O.D.	I.D.
	E-2298	Washer	Eaton 42208			1/32"	2-3/4"	1-17/32"
	E-2297	Axle Spindle Lock Washer	Meritor 1229G475 Eaton 4-2207 Ford 8EB3293			3/16"	2-3/4"	1-17/32"
	E-2296	Outer Axle Spindle Nut	Meritor 1227B106 Navistar 141132H Eaton 4-2206	2-1/4"	1-1/2"-12	7/16"		
	E-2299	Inner Axle Spindle Nut	Meritor 1227L194 Meritor 1227U541 Eaton 4-2205 Meritor A1227A105 Ford C9HZ3295A	2-5/8"	1-1/2"-12	3/8"		





STEERING AXLE SPINDLE HARDWARE

For Light, Medium, and Heavy-Duty Trucks



MERITOR FE-970 AND "E" SERIES DRIVE AXLES

	EUCLID NO.	DESCRIPTION	REPLACES	ACROSS FLATS	THREAD SIZE	THICKNESS	WASHERS	
							O.D.	I.D.
	E-2301	Axle Spindle Lock Washer	Meritor 1229S721 Trailmobile 21-L1336 Eaton 4-2210			1/16"	3-5/16"	2-1/4"
	E-2302	Thrust Washer	Meritor 1229H1568 Eaton 4-2211			1/4"	4-5/16"	2-1/4"
	E-2300	Axle Spindle Nut	Meritor 1227F162 Eaton 4-2209	2-7/8"	2-1/4"-16	5/16"		

MERITOR FG-900 AXLE

	EUCLID NO.	DESCRIPTION	REPLACES	ACROSS FLATS	THREAD SIZE	THICKNESS	WASHERS	
							O.D.	I.D.
	E-2659	Axle Spindle Washer	Meritor 1229J478			1/32"	3-1/4"	1-25/32"
	E-2660	Lock Washer	Meritor 1229H476			7/32"	3-1/4"	1-25/32"
	E-3510	Inner Nut	Meritor A1227C107		1-3/4"-12	1/2"	3-5/16"	
	E-2658	Outer Axle Spindle Nut	Meritor 1227D108	2-1/2"	1-3/4"-12	11/16"		



MERITOR 16,000 LB. AXLE

	EUCLID NO.	DESCRIPTION	REPLACES	ACROSS FLATS	THREAD SIZE	THICKNESS	WASHERS	
							O.D.	I.D.
	E-2659	Axle Spindle Washer	Meritor 1229J478			1/32"	3-1/4"	1-25/32"
	E-2660	Lock Washer	Meritor 1229H476			7/32"	3-1/4"	1-25/32"

STEERING AXLE SPINDLE HARDWARE



For Light, Medium, and Heavy-Duty Trucks

MERITOR 16,000 LB. AXLE (Continued)

	EUCLID NO.	DESCRIPTION	REPLACES	ACROSS FLATS	THREAD SIZE	THICKNESS	WASHERS	
							O.D.	I.D.
	E-2661	Inner Nut	Meritor A1227A391		1-3/4"-12	1/2"	4-3/16"	
	E-2658	Outer Axle Spindle Nut	Meritor 1227D108	2-1/2"	1-3/4"-12	11/16"		

4



MERITOR FH-901, FL-901, FL-931 AXLES

	EUCLID NO.	DESCRIPTION	REPLACES	ACROSS FLATS	THREAD SIZE	THICKNESS	WASHERS	
							O.D.	I.D.
	E-2663	Axle Thrust Washer	Meritor 1229C1693			1/4"	4-1/8"	1-25/32"
	E-2662	Axle Spindle Nut	Meritor 1227Y571 Meritor KIT1416	2-5/8"	1-3/4"-12	1-3/8"		



DRIVE AXLE SPINDLE HARDWARE

For Light, Medium, and Heavy-Duty Trucks

CHEVROLET & GMC H150

	EUCLID NO.	DESCRIPTION	REPLACES	ACROSS FLATS	THREAD SIZE	THICKNESS	WASHERS	
							O.D.	I.D.
	E-4873	Lock Washer	GMC 473629			1/16"	3-1/8"	2-1/8"
	E-4856	Axle Spindle Nut	GMC 473636	2-7/8"	2-1/8"-16	3/8"		



CHEVROLET & GMC T150 & T170

	EUCLID NO.	DESCRIPTION	REPLACES	ACROSS FLATS	THREAD SIZE	THICKNESS	WASHERS	
							O.D.	I.D.
	E-4876	Lock Washer	GMC 3874371			5/64"	3-7/8"	2-1/2"
	E-4858	Axle Spindle Nut	GMC 3703711	3-5/8"	2-1/2"-16	3/8"		



DRIVE AXLE SPINDLE HARDWARE

For Light, Medium, and Heavy-Duty Trucks



EATON 32M-MR, -34M, -MF, 34D-DT-RT, 17800-17801 SERIES AXLES

	EUCLID NO.	DESCRIPTION	REPLACES	ACROSS FLATS	THREAD SIZE	THICKNESS	WASHERS	
							O.D.	I.D.
	E-2461	Lock Washer	Trailmobile 21-L1360 Eaton 30714 Eaton 4-2228 Ford EQH1124			1/8"	4"	2-5/8"
	E-2460	Drive Axle Spindle Nut	Eaton 34090 Eaton 4-2229 Navistar 67675R92	3-3/8"	2-5/8"-12	1"		
	E-2462	Inner Axle Spindle Nut	Meritor 1227E1045 Meritor 1227M715 Eaton 19186 Eaton 4-2227 Eaton 42226 Navistar 67678-R1 Ford D74Z4245A Ford D7HZ4245A	3-7/16"	2-5/8"-12	15/32"		

EATON 38R3, RP-RT, 42R3-RP-RT, 18800, 18801-02-03 SERIES AXLES

	EUCLID NO.	DESCRIPTION	REPLACES	ACROSS FLATS	THREAD SIZE	THICKNESS	WASHERS	
							O.D.	I.D.
	E-2464	Axle Spindle Lock Washer	Eaton 4-2231 Eaton 90180			1/8"	4-1/2"	3"
	E-2465	Inner Axle Spindle Nut	Navistar 17903HA Eaton 4-2230 Eaton 90229	3-13/16"	3"-12	3/8"		
	E-2463	Outer Axle Spindle Nut	Eaton 31926 Eaton 4-2232	3-13/16"	3"-12	1"		



EATON 32M-MR, -34M, -MF, 34D-DT-RT, 17800-17801 SERIES AXLES

	EUCLID NO.	DESCRIPTION	REPLACES	ACROSS FLATS	THREAD SIZE	THICKNESS	WASHERS	
							O.D.	I.D.
	E-2467	Axle Spindle Lock Washer	Eaton 11245 Eaton 4-2234			1/8"	4-3/4"	3-1/4"
	E-2468	Inner Axle Spindle Nut	Eaton 011249 Eaton 4-2233	4-1/8"	3-1/4"-12	1/2"		

DRIVE AXLE SPINDLE HARDWARE

For Light, Medium, and Heavy-Duty Trucks

FORD 15,000 LB. REAR AXLE





	EUCLID NO.	DESCRIPTION	REPLACES	ACROSS FLATS	THREAD SIZE	THICKNESS	WASHERS	
							O.D.	I.D.
	E-4878	Lock Washer	Ford B6Y1124A			1/16"	3"	2"
	E-4862	Axle Spindle Nut	Ford B6Y4252	2-9/16"	2"-16	5/16"		
	E-4863	Axle Spindle Nut	Ford D5UZ4255A	2-9/16"	2"-16	2-1/32"		

4

FORD 17,500 LB. REAR AXLE

	EUCLID NO.	DESCRIPTION	REPLACES	ACROSS FLATS	THREAD SIZE	THICKNESS	WASHERS	
							O.D.	I.D.
	E-4864	Axle Spindle Nut	Ford B4TZ4255A	3-1/2"	2-1/2"-16	3/8"		



FORD 18,000 LB. REAR AXLE

	EUCLID NO.	DESCRIPTION	REPLACES	ACROSS FLATS	THREAD SIZE	THICKNESS	WASHERS	
							O.D.	I.D.
	E-2461	Lock Washer	Trailmobile 21-L1360 Eaton 30714 Eaton 4-2228 Ford EQH1124			1/8"	4"	2-5/8"
	E-573 ³	Axle Spindle Lock Washer	Dana/Spicer 10287 Meritor 1229V1660 Meritor 1229W2545 Eaton 4-2195 Trailmobile 700-7-12 Ford 7EQ1124 Ford 7EQ1124A Eaton 820396 Hendrickson Turner A-1987 Meritor A1229W2545 Dana/Spicer M10HN100			1/4"	3-15/16"	2-41/64"
	E-2462	Inner Axle Spindle Nut	Meritor 1227E1045 Meritor 1227M715 Eaton 19186 Eaton 4-2227 Eaton 42226 Navistar 67678-R1 Ford D74Z4245A Ford D7HZ4245A	3-7/16"	2-5/8"-12	15/32"		
	E-6142	Axle Spindle Nut	Meritor 1227Z1040 Eaton 42225 Ford D7HZ4255A	3-1/2"	2-5/8"-12	3/8"		

DRIVE AXLE SPINDLE HARDWARE





For Light, Medium, and Heavy-Duty Trucks

MACK 50,000 LB.

	EUCLID NO.	DESCRIPTION	REPLACES	ACROSS FLATS	THREAD SIZE	THICKNESS	WASHERS	
							O.D.	I.D.
	E-2304	Axle Spindle Lock Washer	Eaton 119882 Meritor 1229U1009 Mack 23QJ-201 Eaton 4-2224			3/16"	4-3/8"	3-1/4"
	E-2305	Outer Axle Spindle Nut	Eaton 119881 Meritor 1227R330 Mack 25QJ-36 Eaton 4-2223	4"	3-1/4"-12	3/8"		
	E-2303	Inner Axle Spindle Nut	Eaton 119883 Meritor 1227W517 Mack 25QJ-35 Eaton 4-2222 Meritor A1227S331	4"	3-1/4"-12	3/8"		

MACK 55,000, 58,000, 65,000 LB.

SW-50C, SW-55C, SW-58C, SW-65C, S-50C, S-55C, S-58C, S-65C

	EUCLID NO.	DESCRIPTION	REPLACES	ACROSS FLATS	THREAD SIZE	THICKNESS	WASHERS	
							O.D.	I.D.
	E-6146	Lock Washer	Mack 23QJ117B			1/4"	5-1/4"	3-9/16"
	E-6148	Thrust Washer	Mack 35AX338			1/4"	6-3/8"	4"
	E-6145	Axle Spindle Nut	Mack 25QJ225	5-1/4"	3-9/16"-12	1/2"		
	E-6147	Axle Spindle Nut	Mack 21AX863	5-1/4"	3-9/16"-12	1/2"		

If you detect any

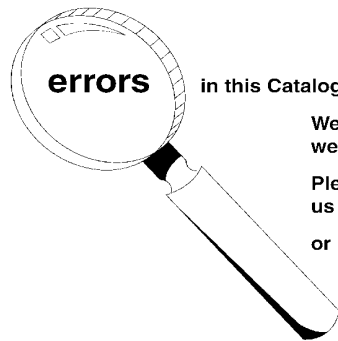

errors

in this Catalog, please let us know.

We want the information to be as accurate as possible; we appreciate your help in making it so.

Please e-mail any comments/suggestions/corrections to us at: catalogfeedback@arvinmeritor.com





or mail to:

Euclid Industries, LLC
Attn: Catalog Dept.
7975 Dixie Highway
Florence, KY 41042-2754

DRIVE AXLE SPINDLE HARDWARE



For Light, Medium, and Heavy-Duty Trucks

MACK SW-56C SERIES AXLE



	EUCLID NO.	DESCRIPTION	REPLACES	ACROSS FLATS	THREAD SIZE	THICKNESS	WASHERS	
							O.D.	I.D.
	E-3505	Axle Spindle Lock Washer	Mack 23QJ129 Mack 25QJ125			5/32"	4-7/16"	2-57/64"
	E-6144	Washer	Mack 35AX1411			1/4"	4-1/8"	3-1/4"
	E-3504	Inner Axle Spindle Nut	Mack 25QJ168	4-1/8"	2-7/8"-12	3/8"		
	E-3506	Outer Axle Spindle Nut	Mack 21AX626	4-1/8"	2-7/8"-12	3/8"		

4

MACK SW-57C SERIES AXLES

	EUCLID NO.	DESCRIPTION	REPLACES	ACROSS FLATS	THREAD SIZE	THICKNESS	WASHERS	
							O.D.	I.D.
	E-3508	Axle Spindle Lock Washer	Mack 23QJ12B			1/4"	4-7/16"	2-61/64"
	E-3509	Outer Axle Spindle Nut	Mack 21AX335	4-1/8"	2-15/16"-12	3/8"		
	E-3507	Inner Axle Spindle Nut	Mack 25QJ13	4-1/8"	2-15/16"-12	3/8"		



NAVISTAR 14039 (INTERNATIONAL/DANA F170S) 17,000 LBS.
 NAVISTAR 14042 (INTERNATIONAL/DANA J175S) 17,500 LBS.
 NAVISTAR 14199 (EATON 16244) 17,500 LBS.
 NAVISTAR 14341 (INTERNATIONAL/DANA RA341) 30,000 LBS.

	EUCLID NO.	DESCRIPTION	REPLACES	ACROSS FLATS	THREAD SIZE	THICKNESS	WASHERS	
							O.D.	I.D.
	E-4881	Lock Washer	Navistar 36416-HB			1/8"	3-3/4"	2-17/32"
	E-4857	Axle Spindle Nut	Meritor 1227G709 Navistar 36415-HB	3-1/4"	2-1/2"-12	11/32"		



DRIVE AXLE SPINDLE HARDWARE

For Light, Medium, and Heavy-Duty Trucks

NAVISTAR 14044 (INTERNATIONAL/DANA J190S) 19,000 LBS.
 NAVISTAR 14186 (EATON 17202/22) 19,000 LBS.
 NAVISTAR 14351 (INTERNATIONAL/DANA G340S) 34,000 LBS.

	EUCLID NO.	DESCRIPTION	REPLACES	ACROSS FLATS	THREAD SIZE	THICKNESS	WASHERS	
							O.D.	I.D.
	E-4877	Lock Washer	Navistar 470422-C1			1/8"	4-1/16"	2-5/8"
	E-2462	Inner Axle Spindle Nut	Meritor 1227E1045 Meritor 1227M715 Eaton 19186 Eaton 4-2227 Eaton 42226 Navistar 67678-R1 Ford D74Z4245A Ford D7HZ4245A	3-7/16"	2-5/8"-12	15/32"		

NAVISTAR 14308 (EATON DS402P) 40,000 LBS.
 NAVISTAR 14309 (EATON RT402) 40,000 LBS.
 NAVISTAR 14342, 14464 (EATON DT401P) 40,000 LBS.
 NAVISTAR 14311 (EATON RS460/461) 46,000 LBS.
 NAVISTAR 14364 (EATON RS401) 40,000 LBS.
 NAVISTAR 14493 (EATON RS341) 34,000 LBS.
 NAVISTAR 14494 (EATON RS381/402) 38,000 LBS.
 NAVISTAR 14277 (MERITOR U240) 29,000 LBS.
 NAVISTAR 14348 (MERITOR SQHD) 38,000 LBS.
 NAVISTAR 14338, 14336 (MERITOR SRDD) 44,000 LBS.
 NAVISTAR 14368 (MERITOR STDD) 50,000 LBS.

	EUCLID NO.	DESCRIPTION	REPLACES	ACROSS FLATS	THREAD SIZE	THICKNESS	WASHERS	
							O.D.	I.D.
	E-6141	Lock Washer	Navistar 581694-C1			1/8"	4-3/4"	3-1/4"
	E-6140	Axle Spindle Nut	Meritor 1227V464 Navistar 157501-R1	4-1/8"	3-1/4"-12	3/8"		





an **ArvinMeritor™** brand

DRIVE AXLE SPINDLE HARDWARE



For Light, Medium, and Heavy-Duty Trucks

MERITOR "F" SERIES AXLES

	EUCLID NO.	DESCRIPTION	REPLACES	ACROSS FLATS	THREAD SIZE	THICKNESS	WASHERS	
							O.D.	I.D.
	E-2418	Axle Spindle Lock Washer	Meritor 1229C1459			5/32"	3-3/4"	2-1/2"
	E-2419	Outer Axle Spindle Nut	Meritor 1227D446	3-1/2"	2-1/2"-16	5/16"		
	E-2417	Inner Axle Spindle Nut	Meritor 1227U515	3-1/2"	2-1/2"-16	5/16"		



4

MERITOR "H" SERIES AXLES

	EUCLID NO.	DESCRIPTION	REPLACES	ACROSS FLATS	THREAD SIZE	THICKNESS	WASHERS	
							O.D.	I.D.
	E-2421	Axle Spindle Lock Washer	Meritor 1229G1021 Eaton 4-2218			3/16"	3-3/4"	2-5/8"
	E-2422	Outer Axle Spindle Nut	Meritor 1227T228 Eaton 4-2217	3-1/2"	2-5/8"-16	5/16"		
	E-2420	Inner Axle Spindle Nut	Meritor 1227T540 Eaton 4-2216 Meritor A1227T540	3-1/2"	2-5/8"-16	5/16"		

MERITOR SPECIAL "H" SERIES AXLES



H-145, H-162, H-172, H-240, H-262, H-362, H-350

	EUCLID NO.	DESCRIPTION	REPLACES	ACROSS FLATS	THREAD SIZE	THICKNESS	WASHERS	
							O.D.	I.D.
	E-2421	Axle Spindle Lock Washer	Meritor 1229G1021 Eaton 4-2218			3/16"	3-3/4"	2-5/8"
	E-2462	Inner Axle Spindle Nut	Meritor 1227E1045 Meritor 1227M715 Eaton 19186 Eaton 4-2227 Eaton 42226 Navistar 67678-R1 Ford D74Z4245A Ford D7HZ4245A	3-7/16"	2-5/8"-12	15/32"		
	E-6142	Axle Spindle Nut	Meritor 1227Z1040 Eaton 42225 Ford D7HZ4255A	3-1/2"	2-5/8"-12	3/8"		



DRIVE AXLE SPINDLE HARDWARE

For Light, Medium, and Heavy-Duty Trucks

MERITOR "L" SERIES AXLES

	EUCLID NO.	DESCRIPTION	REPLACES	ACROSS FLATS	THREAD SIZE	THICKNESS	WASHERS	
							O.D.	I.D.
	E-2424	Axle Spindle Lock Washer	Meritor 1229R1058 Eaton 4-2221			3/16"	4-1/4"	3"
	E-2425	Outer Axle Spindle Nut	Meritor 1227H346 Eaton 4-2220	4"	3"-12	3/8"		
	E-2423	Inner Axle Spindle Nut	Meritor 1227V516 Eaton 4-2219 Meritor A1227V516	4"	3"-12	3/8"		

MERITOR "Q" & "R" SERIES AXLES FOR SQHD & R170 DRIVE AXLES

	EUCLID NO.	DESCRIPTION	REPLACES	ACROSS FLATS	THREAD SIZE	THICKNESS	WASHERS	
							O.D.	I.D.
	E-2304	Axle Spindle Lock Washer	Eaton 119882 Meritor 1229U1009 Mack 23QJ-201 Eaton 4-2224			3/16"	4-3/8"	3-1/4"
	E-2305	Outer Axle Spindle Nut	Eaton 119881 Meritor 1227R330 Mack 25QJ-36 Eaton 4-2223	4"	3-1/4"-12	3/8"		
	E-2303	Inner Axle Spindle Nut	Eaton 119883 Meritor 1227W517 Mack 25QJ-35 Eaton 4-2222 Meritor A1227S331	4"	3-1/4"-12	3/8"		

If you detect any **errors** in this Catalog, please let us know.

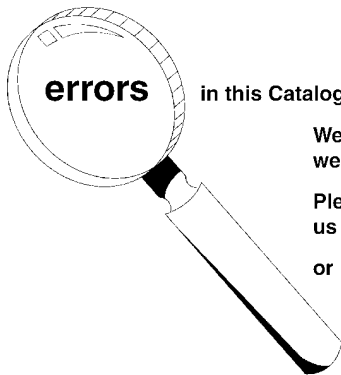

We want the information to be as accurate as possible; we appreciate your help in making it so.

Please e-mail any comments/suggestions/corrections to us at: catalogfeedback@arvinmeritor.com

or mail to: **Euclid Industries, LLC**
Attn: Catalog Dept.
7975 Dixie Highway
Florence, KY 41042-2754

ASSORTMENTS & DISPLAY BOARDS



Board Size: 24" Wide x 28 1/2" High

SPINDLE NUT ASSORTMENT

EUCLID E-7647

SPINDLE NUTS
WITH **FREE** DISPLAY BOARD

Features Euclid's most popular Spindle Nuts for medium and heavy-duty trucks

Included with Display Board are two each of:

EUCLID NO.	DESC.	EUCLID NO.	DESC.	EUCLID NO.	DESC.
E-540	Inner Nut	E-2303	Inner Nut	E-2462	Outer Nut
E-572	Outer Nut	E-2305	Outer Nut	E-2465	Outer Nut
E-618	Nut	E-2417	Inner Nut	E-2468	Outer Nut
E-1087	Nut	E-2419	Outer Nut	E-2550	Nut
E-1251	Outer Nut	E-2420	Inner Nut	E-3504	Inner Nut
E-2128	Service Nut	E-2422	Outer Nut	E-3506	Outer Nut
E-2296	Outer Nut	E-2423	Inner Nut		
E-2299	Inner Nut	E-2425	Outer Nut		

Display Board Only E-7648

SPINDLE WASHER ASSORTMENT

EUCLID E-7649

SPINDLE WASHERS
WITH **FREE** DISPLAY BOARD

Features Euclid's most popular Spindle Washers for medium and heavy-duty trucks

Included with Display Board:

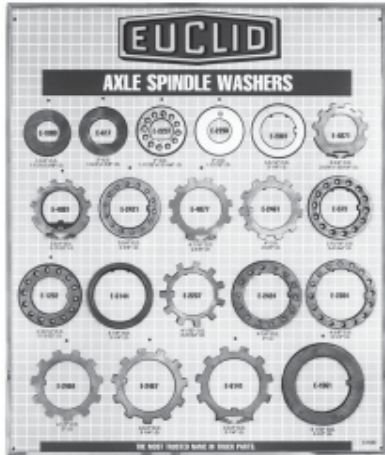

Board Size: 24" Wide x 28 1/2" High

QTY.	EUCLID NO.	DESCRIPTION	QTY.	EUCLID NO.	DESCRIPTION
2	E-573	Lock Washer	2	E-2421	Lock Washer
12	E-617	Lock Washer	2	E-2424	Lock Washer
12	E-1000	Lock Washer	6	E-2461	Lock Washer
2	E-1252	Lock Washer	6	E-2464	Lock Washer
2	E-1561	Spindle Washer	6	E-2467	Lock Washer
12	E-2237	Lock Washer	2	E-4871	Lock Washer
2	E-2297	Lock Washer	2	E-4877	Lock Washer
2	E-2298	Spindle Washer	2	E-4881	Lock Washer
2	E-2301	Lock Washer	2	E-6141	Lock Washer
2	E-2304	Lock Washer	2	E-6144	Tab Washer

Display Board Only E-7650

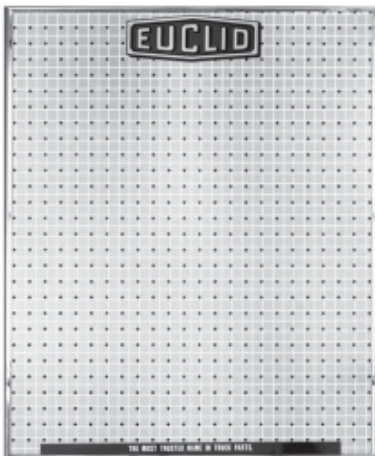

Board Size: 24" Wide x 28 1/2" High

UNIVERSAL DISPLAY BOARD

EUCLID E-7657

This Euclid Display Board provides the flexibility to feature specific promotional products, monthly specials, or new products. An assortment of hangers and hooks and two plan-o-grams are included to illustrate how the Board may be used.

WHEEL HUB CAPS



GREASE HUB CAP

	EUCLID NO.	REPLACES	BOLT CIRCLE DIA.	O.D.	I.D.	BOLT HOLE DIA.	NO. OF BOLT HOLES	COMMENTS
	E-975	Trailmobile 19143 Meritor 3262S45 Meritor 3262W1245	5-1/2"	6-1/8"	4-1/2"	5/16"	6	Use with E-03009 Gasket

HUB CAP GASKET

	EUCLID NO.	BOLT CIRCLE DIA.	O.D.	I.D.	BOLT HOLE DIA.	NO. OF BOLT HOLES
	E-03009	5-1/2"	6-3/8"	4-27/64"	5/16", 3/8"	3, 5, 6

HUB CAP FOR FRUEHAUF "PRO-PAR" AXLE

	EUCLID NO.	DESCRIPTION	COMMENTS/REPLACES	THREAD SIZE
	E-04075V	Vented Hub Cap	For use with non-Fruehauf/Pro-Par axles.	6-1/4"-8
	E-04075	Hub Cap	Fruehauf ACC-007538-900	6-1/4"-8
	E-04075H	Hub Cap	Hub Cap includes O-Ring and Filler Plug. For use with Hubodometers.	6-1/4"-8
	E-04075AH	Hub Cap	Hub Cap includes O-Ring and Filler Plug. For use with Hubodometers. Aluminum Cover.	6-1/4"-8

S.O.S.

Special Order Service

Can't find it?

Trouble sourcing products?

Need assistance?

Let Euclid's Special Order Service (S.O.S.) help you find your parts.

Euclid's position as the market leader provides you access to a comprehensive array of truck parts products from the industry's leading manufacturers. Through Euclid, these entire product lines are available to you just by placing a phone call to Euclid's S.O.S.

Department at 866-238-2543 (option 2) in the U.S. or 800-387-3889 in Canada.

WHEEL HUB CAPS

HUB CAP O-RING

	EUCLID NO.	DESCRIPTION	REPLACES	O.D.	I.D.
	E-05500	O-Ring	Fruehauf AXA-0484-1	6"	5-1/2"

HUB CAP PLUGS

EUCLID NO.	DESCRIPTION	COMMENTS/REPLACES
E-04000	Hub Cap Filler Plug	Fruehauf AXA-1005-1
E-04000V	Vented Hub Cap Filler Plug	For use with non-Fruehauf/Pro-Par axles.

4

FLEET VEHICLE MAINTENANCE COMPONENTS

The Euclid Brand offers "All-Makes" Aftermarket Maintenance Components for these Vehicle Systems:

BRAKE PRODUCTS

- Euclid New Lined Brake Shoes
- Euclid Relined Brake Shoes
- Euclid Friction Materials
- Camshafts
- Air Drum Brake Components & Kits
- Air Disc Pads & Components
- Hydraulic Disc Pads
- Hydraulic Drum & Disc Brake Components
- Automatic & Manual Slack Adjusters
- Brake & Camshaft Repair Kits

WHEEL END PRODUCTS

- Cast Brake Drums
- X-30 Steelite Brake Drums
- Hubs & Spoke Wheels
- Rotors - Hydraulic Disc
- Wheel Attaching Components
- Seals & Bearings

DRIVELINE PRODUCTS

- Universal Joints - US only
- Center Bearings - US only
- Miscellaneous Hardware - US only

TRAILER PRODUCTS

- Axle Tubes
- "Dressed" Axles

FRONT AXLE PRODUCTS

- King Pin Kits
- Tie Rod & Drag Link Ends
- Drag Links

SUSPENSION PRODUCTS

- Air Springs
- Equalizers, Hangers, Beams
- Bushings & Hardware
- Speciality Polyurethane Components
- Torque Rods
- U-Bolts
- Gabriel®** Shock Absorbers

AIR SYSTEM PRODUCTS

- Air Dryers & Cartridges
- Air Valves - New & Reman
- Reman Air Compressors
- Air Brake Hose & Fittings

OTHER PRODUCTS

- Ankra Cargo Restraint Systems
- Chrome and Stainless Steel Accessories

EUCLID DRIVE AXLE GASKET ASSORTMENT

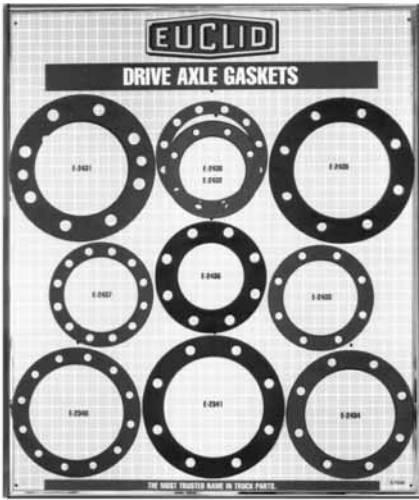

EUCLID E-7655

DRIVE AXLE GASKETS
WITH *FREE* DISPLAY BOARD

Included with Display Board are 25 each of:

E-2340 E-2434
E-2341 E-2435
E-2431 E-2436
E-2432 E-2437
E-2433 E-2438

Display Board only E-7656

DRIVE AXLE FLANGE GASKETS



TYPE 1

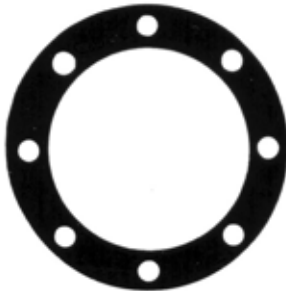

TYPE 2



TYPE 3



TYPE 4

EUCLID GASKET NO.	TYPE	O.D.	I.D.	BOLT CIRCLE DIA.	BOLT SIZE	NO. OF BOLT HOLES
E-2432	2	5-9/16"	4"	4-3/4"	7/16"	8
E-10237	2	6"	4-5/16"	5-1/8"	1/2"	8
E-2437	3	6-1/16"	4-1/2"	5-1/4"	9/16"	12
E-2433	2	6-1/8"	4-1/2"	5-9/32"	1/2"	8
E-2436	2	6-7/16"	4"	5-1/2"	5/8"	8
E-2438	3	6-1/2"	5"	5-11/16"	7/16"	12
E-2434	2	7-3/8"	5-3/8"	6-3/8"	9/16"	8
E-2340	3	7-7/16"	5-11/16"	6-9/16"	1/2"	12
E-2341	2	8-1/4"	6"	7"	5/8"	8
E-2435	2	8-3/8"	5-3/4"	7"	5/8"	8
E-2431	1	8-1/2"	5-5/8"	7"	3/4"	8
E-10238	4	8-1/2"	6-7/16"	7-7/16"	11/16"	6