



SERVICE MANUAL

HWH® TOUCH PANEL-CONTROLLED 625 SERIES HYDRAULIC LEVELING SYSTEM

FEATURING:

Touch Panel Leveling Control
BI-AXIS® Hydraulic Leveling
(Without Dump)
(With Dump)
(With Pilot Dump)

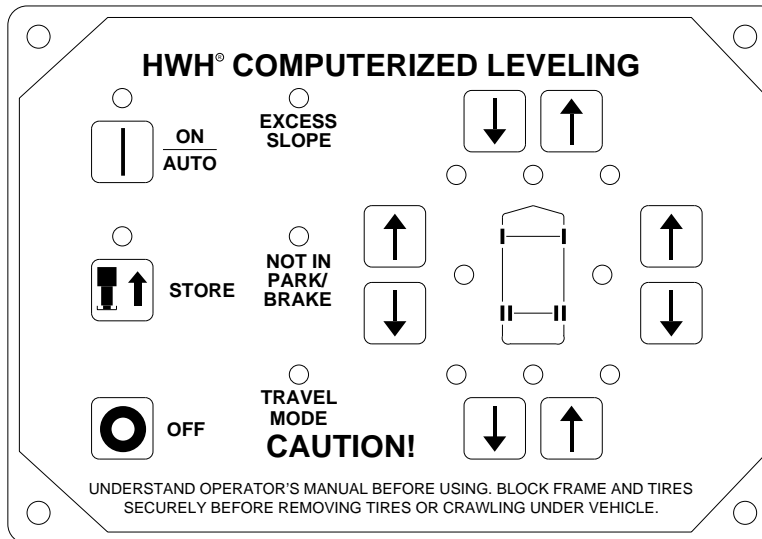

HWH CORPORATION

(On I-80, Exit 267 South)

2096 Moscow Road | Moscow, Iowa 52760

Ph: 800/321-3494 (or) 563/724-3396 | Fax: 563/724-3408

www.hwh.com

SECTION 1

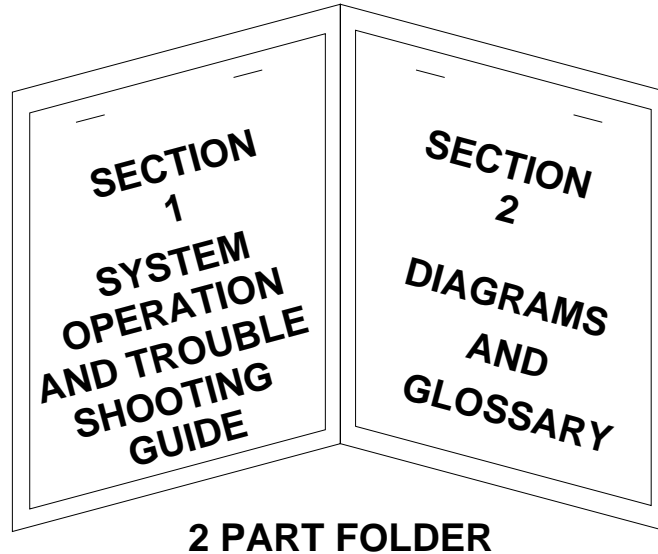

HOW TO USE MANUAL

This manual is written in two sections. Section 1 is System Operation and Trouble Shooting Steps. Section 2 is the Diagrams and Parts Glossary. Begin diagnosis of the system with Section 1. This will give the correct operation and function of the system. The Trouble Shooting Steps are written in order of operation. The Trouble Shooting Steps should be followed in order to avoid improper diagnosis of the system. Section 2 contains diagrams and a parts glossary. Refer to diagrams as directed in the Trouble Shooting Steps. The parts glossary explains the function of individual parts.

Before beginning your repair, it is **IMPORTANT** to read the **CAUTIONS** and **NOTES AND CHECKS** in the first section, **TROUBLE SHOOTING GUIDE**. In many cases this will save time and mistakes when trouble shooting a system.

This Repair Manual is offered as a guide only. It is impossible to anticipate every problem or combination of problems. For any problems encountered that are not addressed in this manual, contact HWH Corporation for assistance. (800-321-3494)

PROCEED WITH SYSTEM OPERATION



TROUBLE SHOOTING

WARNING!

BLOCK FRAME AND TIRES SECURELY BEFORE CRAWLING UNDER VEHICLE. DO NOT USE THE LEVELING JACKS OR AIR SUSPENSION TO SUPPORT VEHICLE WHILE UNDER VEHICLE OR CHANGING TIRES. VEHICLE MAY DROP AND OR MOVE FORWARD OR BACKWARD WITHOUT WARNING CAUSING INJURY OR DEATH.

WHEN ROUTING OR REROUTING HYDRAULIC HOSES AND WIRES, BE SURE THEY ARE NOT EXPOSED TO ENGINE EXHAUST OR ANY HIGH TEMPERATURE COMPONENTS OF THE VEHICLE.

NEVER PLACE HAND OR OTHER PARTS OF THE BODY NEAR HYDRAULIC LEAKS. OIL MAY CUT AND PENETRATE THE SKIN CAUSING INJURY OR DEATH.

SAFETY GLASSES ARE TO BE WORN TO PROTECT EYES FROM DIRT, METAL CHIPS, OIL LEAKS, ECT. FOLLOW ALL OTHER SHOP SAFETY PRACTICES.

NOTES AND CHECKS

Read and check before proceeding with Trouble Shooting Steps.

NOTE: HWH CORPORATION ASSUMES NO LIABILITY FOR DAMAGES OR INJURIES RESULTING FROM THE INSTALLATION OR REPAIR OF THIS PRODUCT.

1. If the jacks cannot be retracted, see TROUBLE SHOOTING PART 15 Step 2 for temporary measures. Make sure the manual retract valves are closed before trouble shooting.
2. The Trouble Shooting Guide must be followed in order. Problems checked for in one step are assumed correct and may not be checked again in following steps.
3. Check that the oil reservoir is full with the jacks in the fully retracted position. If the vehicle is equipped with HWH room extensions, refer to the HWH Owners Manual for proper position of the room when checking the oil level.
4. Most coaches have more than one battery; one for the engine and the other(s) for the coach. The engine battery supplies power for the control box and hydraulic pump. Batteries under no load should read 12.6 volts. Batteries must maintain good voltage under load. Batteries must be in good condition with no weak cells. An alternator, converter or battery charger will not supply enough power for the system to operate properly.
5. Proper grounding of all components is critical. See the electrical circuit for specific grounds required. Faulty grounds, especially for the control box, solenoid manifold or the pump assembly, may cause control box component damage and /or improper or erratic operation.

6. Do not replace the control box unless the Repair Steps say to replace it. Otherwise the malfunctions may damage the new control box.

This manual is intended for use by experienced mechanics with knowledge of hydraulic and automotive electrical systems. People with little or no experience with HWH leveling systems should contact HWH technical service (800-321-3494) before beginning. Special attention should be given to all cautions, wiring, and hydraulic diagrams.

Special note: When installing a new control box, make sure the box is properly grounded before applying power to the system.

Tightening of hose ends: If tightening a new hose end, make the hose end snug (finger tight) on the fitting, then tighten the hose end 1/3 turn (2 FLATS). If tightening an existing hose end, tighten the hose end to snug plus 1/4 turn (1 FLAT).

Suggested tools for trouble shooting the HWH leveling systems:
JUMPER WIRES (UP TO 10 GAUGE)
PRESSURE GAUGE (3500 PSI MIN.)
MULTI-METER
12 VOLT TEST LIGHT

PROCEED WITH THE TROUBLE SHOOTING STEPS ON THE FOLLOWING PAGE



CONTROL IDENTIFICATION

625 SERIES LEVELING SYSTEM

COMPUTER-CONTROL

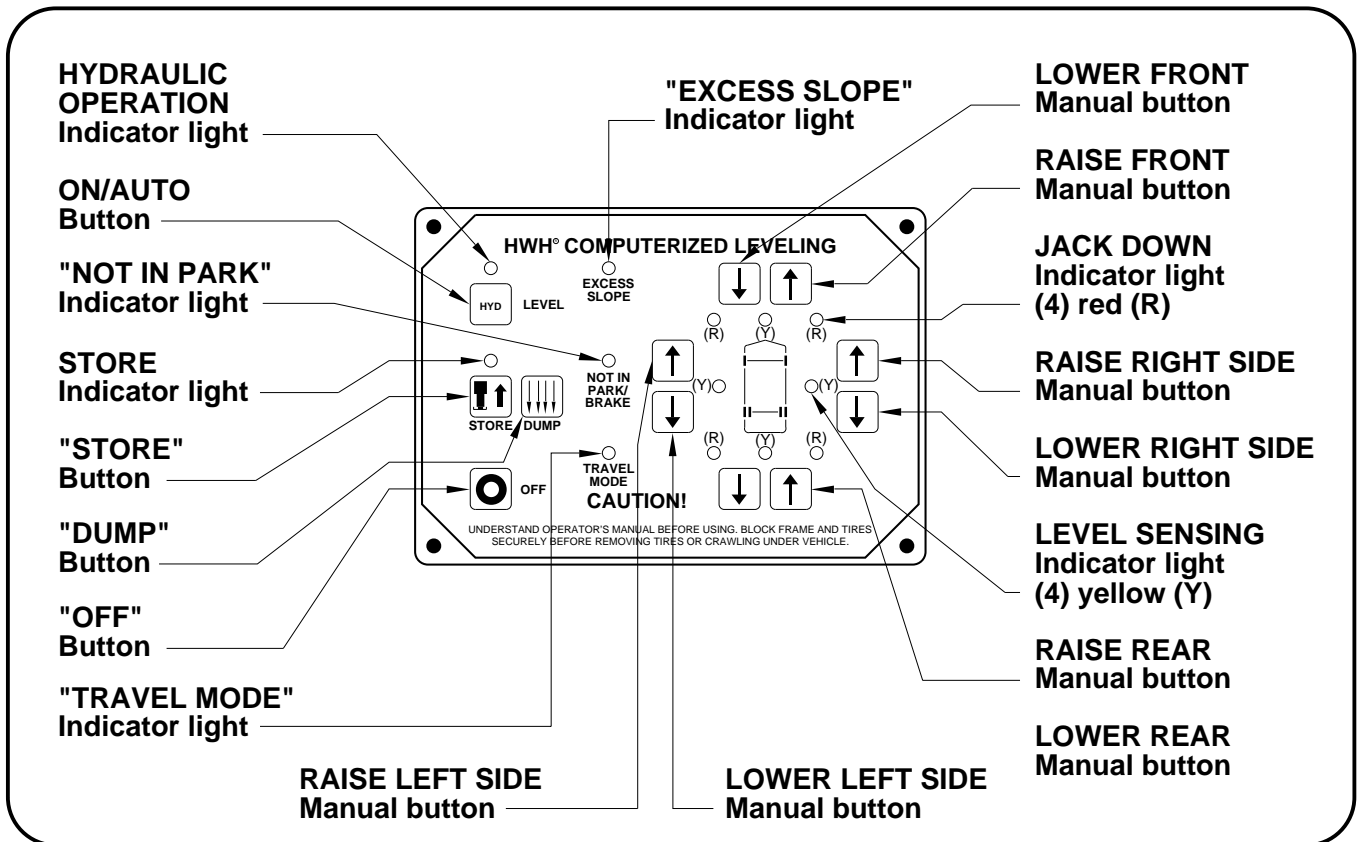

CONTROL FUNCTIONS

CONTROL BUTTONS

ON/AUTO BUTTON: This is the ON button and automatic operation button. The ON indicator light is above the (HYD) button.

"OFF" BUTTON: Push the "OFF" button to stop hydraulic operation.

"STORE" BUTTON: The store indicator light is above the "STORE" button. This button is used to automatically retract the jacks.

"DUMP" BUTTON: This is the manual button for dumping air from the vehicle suspension.

EXTEND BUTTONS (UP ARROWS): These buttons will extend their respective jack pairs to lift the vehicle.

RETRACT BUTTONS (DOWN ARROWS): These buttons will retract their respective jack pairs to lower the vehicle.

INDICATOR LIGHTS

HYDRAULIC OPERATIONS (I) LIGHT: This light indicates that the panel is active.

"NOT IN PARK/BRAKE" LIGHT: This indicator will light when the hand/auto brake is not set and the "LEVEL" button is being pushed.

INDICATOR LIGHTS (Continued)

STORE LIGHT: This light indicates that the system is in STORE mode.

"TRAVEL MODE" LIGHT: This indicator light will be on when the ignition is on, when the jacks are retracted and there are no red WARNING lights on.

LEVELING LIGHTS: The four yellow indicating lights are level sensing indicators. When a yellow light is on, it indicates that its side, end, or corner of the vehicle is low. No more than two lights should be on at the same time.

JACK DOWN LIGHTS: The four red lights surrounding the yellow level indicators are jacks down WARNING lights. They are functional only when the ignition is in the "ON" or "ACC" position, the system is on, and the jacks are extended 1/4 to 1/2 inch.

MASTER "JACKS DOWN" WARNING LIGHT: This is a light mounted in the dash separate from the touch panel. It will be on when any one or more jacks are extended and the ignition is "ON".

BUZZER: This is a jacks down warning. It will sound if the master "JACKS DOWN" warning light is on.

SYSTEM OPERATION

The 625 leveling system is a computer controlled, BI-AXIS push button system. This system has automatic or optional manual control. This system will always extend two (2) jacks at the same time in the automatic or manual mode, both front jacks, the left front and left rear jacks, the right front and right rear jacks or both rear jacks. In the manual mode, the jacks are controlled by the UP and DOWN arrow buttons on the right hand side of the touch panel. The UP arrows extend jack pairs and the DOWN arrows retract jack pairs.

There are two parts to leveling a vehicle. First the vehicle is leveled. The jacks are used to turn all the yellow level indicators off. The second part of leveling is to stabilize the vehicle. This is accomplished by extending any jacks not used for leveling to the ground and lifting the vehicle about 3/4 to 1 inch.

If the vehicle is equipped with an air suspension, the air must be exhausted from the suspension before leveling the vehicle. If the air is not exhausted, the suspension height control valves will interfere with the leveling procedure. There are two types of air dump systems that HWH controls. One system uses air solenoid valves supplied by HWH. The second system is supplied by the chassis manufacturer. This is a pilot air dump system. In the automatic mode, the air is dumped automatically before the leveling process is started. For manual leveling, the HWH touch panel has a "DUMP" button. The "DUMP" button will only work if the POWER ON light is on. If the vehicle uses the HWH air dump valves, the "DUMP" button must be pushed and held until all of the air is exhausted from the vehicle suspension system. The engine must be off. If a pilot air dump system is used, the engine may be on or off. The "DUMP" button can be pushed and released. The pilot air dump system will return to the travel position if the ignition is on and the "STORE" button is pushed or the park brake is released.

NOTE: Releasing the park brake to return the suspension to travel mode (vehicle to ride height) is not recommended for normal operation. This is a fail safe if the "STORE" button is not used to retract the jacks.

AUTOMATIC OPERATION

The ignition must be in the "ON" or "ACC." position and the park brake must be set to turn the system on. The "NOT IN PARK/ BRAKE" indicator light will come on while the "ON" button is being pushed if the park brake signal is not present. The system will not turn on.

Pushing the "ON" (I) button will turn the system on. The POWER ON light should be lit and the DUMP button (if so equipped) will function.

Push the "ON" (I) button a second time. The POWER ON light will flash. If applicable, the air will dump for thirty (30) seconds before the leveling procedure starts.

On the right hand side of the touch panel there are four (4) red and four (4) yellow indicator lights. The four red indicator lights are JACK DOWN warning lights. There is one light for each jack. These warning lights come on when their respective jacks are extended about 1/4 to 1/2 inch. The four yellow indicator lights are level indicators, front, left side, right side and rear. A lit yellow level light indicates that a side, end or corner is low. When all four yellow level lights are out, the vehicle is level within the tolerance of the level sensing unit.

The computer will extend jack pairs according to the level lights starting with a lit side light. When all four level lights are out, the computer will extend any jacks not used for leveling to stabilize the vehicle. The computer looks for a jack pressure switch from each jack to know all jacks are on the ground. **NOTE: Both front solenoid valves will come on during the stabilize procedure when either front jack pressure switch is not on. When both front jack pressure switches are on, both front solenoid valves will be off.**

EXCESS SLOPE: Excess slope is when one or two jacks extend as far as they can without turning a yellow level light out. The pump will go to relief and trip a 3000# pressure switch on the leveling manifold. The "EXCESS SLOPE" light will come on. Jacks that have not been extended will not extend when the "EXCESS SLOPE" light is on. The "EXCESS SLOPE" light will be on whenever the ignition is on until the park brake is released (with the ignition on) or the jacks are completely retracted with the "STORE" button.

The "OFF" button will turn the system off at any time.

625 TROUBLE SHOOTING GUIDE

MANUAL OPERATION

The ignition must be in the "ON" or "ACC." position and the park brake must be set to turn the system on. The "NOT IN PARK/BRAKE" indicator light will come on while the "ON" button is being pushed if the park brake signal is not present. The system will not turn on.

Pushing the "ON" (I) button will turn the system on. The POWER ON light should be lit. With the POWER ON light on, the UP or DOWN arrows and the DUMP button will function.

Use the DUMP button to dump the air before extending jacks.

On the right hand side of the touch panel there are four (4) red and four (4) yellow indicator lights. The four red indicator lights are JACK DOWN warning lights. There is one light for each jack. These warning lights come on when their respective jacks are extended about 1/4 to 1/2 inch. The four yellow indicator lights are level indicators, front, left side, right side and rear. A lit yellow level light indicates that a side, end or corner is low. When all four yellow level lights are out, the vehicle is level within the tolerance of the level sensing unit.

Use the UP ARROW (Extend jack pairs) and DOWN ARROW (Retract jack pairs) buttons to extend jack pairs as needed to level and stabilize the vehicle. Side level lights should be turned off before turning off front or rear level lights.

The "OFF" button will turn the system off at any time.

STORE MODE

The touch panel has a "STORE" button and light. The "STORE" button will work with the POWER ON light on or off. The ignition must be in the "ON" or "ACC." position. The STORE light will come on when the "STORE" button is pushed. The STORE light will go out six (6) minutes after the last of the four individual red WARNING lights go out. If the POWER ON light is on while the STORE light is on, the POWER ON light will go out at this time also. Vehicles equipped with a pilot air dump system should return to ride height when the "STORE" button is pushed.

The "STORE" button should always be used to retract the jacks. This allows the system to store any jack that extends due to thermal expansion of the hydraulic fluid while traveling. When traveling, if a jack extends enough to allow a jack warning switch to turn on, the processor will turn the appropriate solenoid valve on so the jack can retract. The master warning light and buzzer will NOT come on at this time. If thirty (30) seconds after the solenoid valve is turned on the warning switch is still on, the processor will turn the master warning light, the buzzer and the appropriate red WARNING light on the touch panel on.

IMPORTANT: When testing a leveling system, all four sets of UP and DOWN arrow buttons should be used to make sure the complete system operates correctly, including the red WARNING lights and the yellow LEVEL lights. If the system will not work in the manual mode it is very unlikely the system will function properly in the automatic mode.

625 TROUBLE SHOOTING STEPS

MANUAL OPERATION

NOTE: The following diagnostic functions are written in order of operation and should be checked in this order. Failure to do so may cause improper diagnoses of the problem(s) and increase the time needed to repair the system.

PART 1. WITH THE IGNITION OFF THE HWH TOUCH PANEL SHOULD HAVE NO LIGHTS ON AND SHOULD NOT FUNCTION.

1. If the touch panel has lights on or will function, the red 6120 wire in the touch panel harness is connected to a constant power source and should be moved to the "ACC." side of the ignition switch.
SEE: MP85.102A or MP85.056C

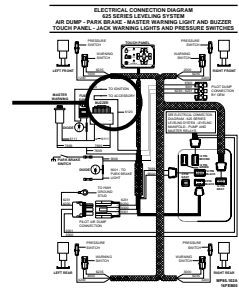

**MP85.102A
OR
MP85.056C**

PART 2. WITH THE IGNITION ON, THE "TRAVEL MODE" LIGHT IS THE ONLY LIGHT ON THE TOUCH PANEL THAT SHOULD BE ON. THE MASTER "JACKS DOWN" LIGHT AND BUZZER SHOULD NOT BE ON.

1. The "TRAVEL MODE" light is not on. The ignition is on, the master "JACKS DOWN" warning light and buzzer are on and none of the jacks are extended.

- a. Check the four yellow LEDs for the warning switch inputs in the control box. Number 21 is for the left front jack, 22 is for the right front jack, 23 is for the right rear jack and 24 is for the left rear jack. If no warning switch LEDs are on, replace the control box. **SEE: MP85.184C**
- b. If a warning switch LED is on, unplug the warning switch for the jacks that have a lit LED. If the LEDs go out, the problem is the warning switch. **NOTE: The magnet in the jack may be bad. If a new switch does not fix the problem, contact HWH customer service. If the LED stays on with the warning switch unplugged, unplug the 12 pin gray connector from the back of the control box. If the LED remains on, replace the control box. If the LED goes out, the warning switch wire(s) for the LEDs that are on are shorted to ground. SEE: MP85.102A or MP85.056C**

NOTE: Make sure the white wires of the harness and warning switch are in the "A" pins of the Packard connectors. The black wires must be in the "B" pins of the connectors.

2. The "TRAVEL MODE" light is not on. The ignition is on, the master "JACKS DOWN" warning light and buzzer are NOT on and none of the jacks are extended.

- a. Push the ON (I or HYD) button. If the panel will turn on replace the control box. If the panel will not turn on, proceed to PART 4.

3. The "TRAVEL MODE" light is on AND the master "JACKS DOWN" warning light and buzzer are on.

- a. Check red LED 32. If the LED is on, replace the control box. **SEE: MP85.184C** If the LED is not on, the 7699 wire going to the master warning light and buzzer is shorted to ground. **SEE: MP85.304R & MP85.102A or MP85.056C**

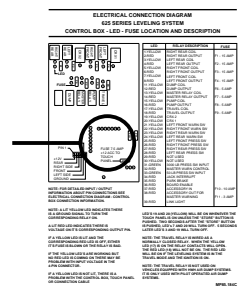

MP85.184C

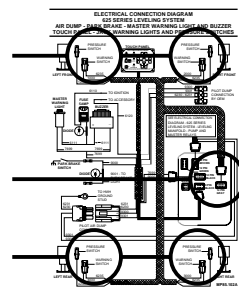

**MP85.102A
OR
MP85.056C**

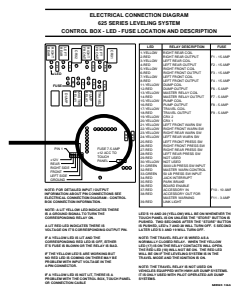

MP85.184C

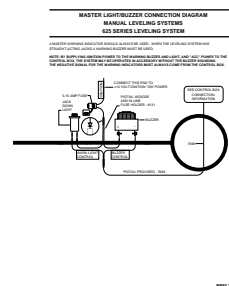

MP85.304R

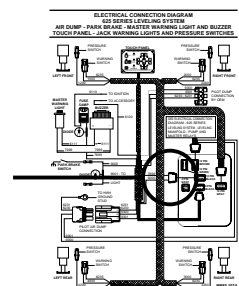

**MP85.102A
OR
MP85.056C**

625 TROUBLE SHOOTING STEPS

MANUAL OPERATION

PART 3. THE PANEL WILL NOT TURN ON. THE IGNITION IS ON. THE "NOT IN PARK/BRAKE" LIGHT IS ON WHILE PUSHING THE LEVEL (I or HYD) BUTTON.

1. Check that the park brake is set.
2. Check LED 35 on the board in the control box. LED 35 should be on.

SEE: **MP85.184C**

- a. If LED 35 is on, replace the control box.
- b. If LED 35 is off, check for a ground on the 9000 wire on pin 7 of the 12 pin black connector on the back of the control box. If there is a ground on wire 9000, unplug the 12 pin black connector and ground pin 7 in the box receptacle. If LED 35 does not come on, replace the control box. If LED 35 does come on the problem is wire 9000 or the 12 pin black connection. If there is no ground on wire 9000, the problem is wire 9000 or the park brake switch. SEE: **MP85.102A or MP85.056C & MP85.186E**

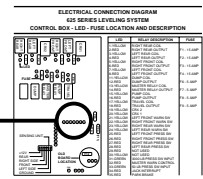

MP85.184C

PART 4. THE PANEL WILL NOT TURN ON. THE IGNITION IS ON. THE "NOT IN PARK/BRAKE" LIGHT IS NOT COMING ON WHEN THE LEVEL (I or HYD) BUTTON IS PUSHED.

1. Check LEDs 36, 37 and 39. They Should be on if the ignition is on. LED 39 will pulsate dimly. SEE: **MP85.185J**

- a. **LED's 36, 37 and 39 are off.** Check fuse F10. If F10 is blown, check the 6800 wire in the touch panel harness, it may be shorted to ground. If the 6800 wire is ok, replace the control box. If F10 is OK, check for +12 volts between PIN 4 (gnd) and PIN 6 (ign) of CN8. If +12 is present, replace the control box. If +12 is not present, check for +12 between T2 and PIN 6 (ign) of CN8. If voltage is present, replace the control box. If +12 is not present, the problem is either the ground for the control box in the 4 pin gray connector or +12 ignition power on wire 6120, PIN 6 of CN8. Voltage to the control box on the 6120 wire should be above 12 volts. SEE: **MP85.185J**

- b. **LED's 36 and 37 are on, LED 39 is off. Check for +12 volts between PIN 4 (ground-white wire) and PIN 5 (+12-red wire) at the touch panel.** Less than 11.3 volts at the touch panel may indicate that there is a low voltage situation for the leveling system but the system may still function. If there is less than 11 volts at the touch panel, the voltage problem should be taken care of before proceeding. If there is a voltage problem, check the voltage between PIN 4 (gnd) and PIN 6 (ign) of CN8 at the control box and PIN 4 (gnd) and PIN 3 (ign out) of CN8. If there is more than 1(one) volt difference, replace the control box. If voltage between PIN 4 and PIN 6 is low, the problem is the ground from the white wire in the 4 pin gray connector or the voltage on the red 6120 wire in the CN8 connector for PIN 6. SEE: **MP85.2930 & MP85.185J**

If there is good voltage between PIN 4 and PIN 5 at the touch panel, check the link light at the touch panel. If it is blinking, the touch panel is probably the problem. If the link light is not blinking check the resistance between PIN 1 (yellow wire) and PIN 2 (green wire) at the touch panel with the harness plugged in. The ignition must be off when checking resistance on these wires. **NOTE: If the vehicle is a towable vehicle or the control box is not wired to the ignition circuit, remove power from the 6120 wire in the 8 PIN black connector CN8.** There should be 60 ohms of resistance ± 7.5 ohms. If the resistance is OK, the problem is probably the control box but could be the touch panel. If the resistance is not correct, unplug the harness from the touch panel. Check the resistance between the yellow and green wire in the harness plug and between PIN 1 and PIN 2 of the panel plug. The resistance should be 120 ohms ± 15 ohms. If the resistance between the panel pins is wrong, replace the touch panel. If the resistance between the harness pins is wrong, unplug the touch panel cable (CN8-8 pin black connector) at the control box. Check the resistance between PIN 7 (CL) and PIN 8 (CH) of CN8 in the control box. If the resistance is OK (120 ohms ± 15 ohms), replace the touch panel cable. If not replace the control box. SEE: **MP85.2930 & MP85.185J**

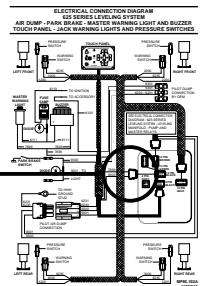

MP85.102A

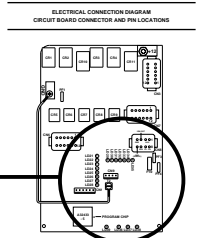

MP85.185J

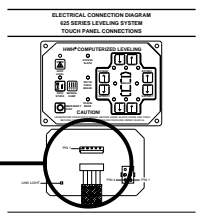

MP85.2930

625 TROUBLE SHOOTING STEPS

MANUAL OPERATION

PART 4. continued. . .

If there is no voltage between PIN 4 and PIN 5 at the touch panel, check for voltage between pins 3 (ign out) and 4 (gnd) of CN8 at the control box. If there is good voltage, the problem is the touch panel cable or it's connections. If there is no voltage between pins 3 and 4, check for voltage on the legs of poly fuse PF3. If there is no voltage on either leg, replace the control box. If there is voltage on one leg of the poly fuse, unplug the touch panel cable at the touch panel and recheck pins 3 and 4. (It will take about 30 seconds for the poly fuse to reset). If voltage is now present, replace the touch panel. If there is still no voltage, remove the 6800 wire from the CN8 connector and recheck pins 3 and 4. If there is voltage now, the 6800 wire is shorted to ground. If voltage is still not present, replace the control box.

SEE: MP85.2930 & MP85.185J & MP85.102K

- c. LED 37 is on. LED 36 is off. LED 39 may or may not be on, blinking. Check voltage between PIN 4 (gnd) and PIN 6 (ign) of CN8 at the control box. If there is less than 12 volts present, check the ground and ignition supply connections for any problems including corrosion. If there is good voltage between pins 4 and 6, replace the control box. SEE: MP85.185J

PART 5. THE PUMP STARTS TO RUN WHEN THE TOUCH PANEL IS TURNED ON.

1. Check LEDs 15 (YELLOW) and 16 (RED)

SEE: MP85.184C

- a. If LEDs 15 and/or 16 are on, replace the control box.
- b. If LEDs 15 and/or 16 are off replace the pump relay. The pump relay contacts are stuck.

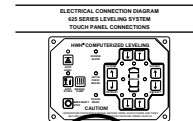

MP85.2930

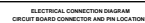

MP85.185J

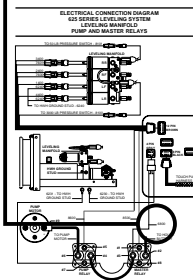

MP85.102K

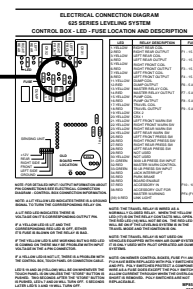

MP85.184C

625 TROUBLE SHOOTING STEPS

MANUAL OPERATION

PART 6. FOR VEHICLES EQUIPPED WITH AN AIR SUSPENSION. THE AIR WILL NOT EXHAUST FROM THE SUSPENSION AIR BAGS WHEN THE "DUMP" BUTTON ON THE TOUCH PANEL IS PUSHED. THE IGNITION AND THE TOUCH PANEL POWER ON LIGHT ARE ON.

1. For vehicles equipped with the HWH air dump valves. There is normally one air dump valve for each height control valve on the suspension. Air will only be exhausted while the "DUMP" button is being pushed.
 - a. Check LEDs 11, 12, 17 and 18 while the "DUMP" button is being pushed. LEDs 11 and 17 (YELLOW) along with LED 12 (RED) should be on. LED 18 (RED) should be off. If LEDs 11 and/or 17 are not on, or LED 18 is on, replace the control box. If LED 11 is on but LED 12 is off, check fuse F6. If F6 is not blown, push any manual UP arrow button. If the pump runs, check for power on the two black wires in the four pin connector on the back of the control box. If power is present, replace the control box. If power is not present, there is a problem with these wires or their connection to the master relay. If the pump does not run, proceed to PART 7. If F6 is blown, there may be a short on the 9300 wire going to the HWH air dump valves or one or more of the air dump valves may be bad.
SEE: MP85.184C
 - b. LEDs 11 and 17 (YELLOW) and LED 12 (RED) are on. LED 18 is off. There should be power on the 9300 wire on pin 11 in the 12 pin brown connector on the back of control box. If not, there is a problem with the connector, pin connections or the 9300 wire. If there is power on the 9300 wire at the control box, check for power between the 9300 (BLACK) wire and the white wire in the Packard connector at the air dump valves. If there is no power, the problem is the 9300 wire, the white ground wire or their pin connections. If power is present at the connectors, replace the air dump valve(s). Check that the exhaust ports for the air dump valves are not plugged.
SEE: MP85.184C & MP85.102K
2. For vehicles equipped with a pilot air dump system supplied by the chassis manufacturer and controlled electronically by the HWH leveling system. The "DUMP" button may be pushed and released. The pilot valve should shift to the dump position and remain there.
 - a. Check LEDs 11, 12, 17 and 18 while the "DUMP" button is being pushed. LEDs 11 and 17 (YELLOW) along with LED 12 (RED) should be on. LED 18 (RED) should be off. If LEDs 11 and/or 17 are not on, or LED 18 is on, replace the control box. If LED 11 is on but LED 12 is off, check fuse F6. If F6 is not blown, push any manual UP arrow button. If the pump runs, check for power on the two black wires in the four pin connector on the back of the control box. If power is present, replace the control box. If power is not present, there is a problem with these wires or their connection to the master relay. If the pump does not run, proceed to PART 7. If F6 is blown, there may be a short on the 9300 wire or a problem with the suspension pilot dump valve. Locate the 4 pin UML connector in the HWH harness. Unplug the 4 pin connector. Replace the F6 fuse and retry. If the fuse blows again, the problem is with the HWH 9300 wire. If the fuse does not blow, the problem is with the pilot dump valve. Contact the vehicle manufacturer for assistance.
SEE: MP85.184C & MP85.102A
 - b. LEDs 11 and 17 (YELLOW) and LED 12 (RED) are on and LED 18 (RED) is off. Find the 4 pin UML plug for the pilot dump in the HWH harness. While pushing the "DUMP" button, check between the pins in the 4 pin UML connector for the black 9300 wire and the white ground wire. If there is no power on the 9300 wire, the problem is the 9300 wire, the white ground wire or their connections. If there is power on the 9300 wire, the problem is the suspension pilot dump valve. Contact the vehicle manufacturer for assistance.
SEE: MP85.184C & MP85.102A

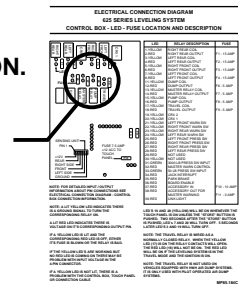

MP85.184C

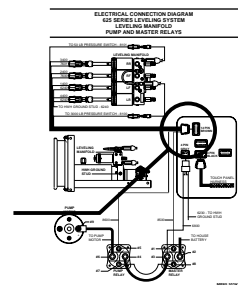

MP85.102K

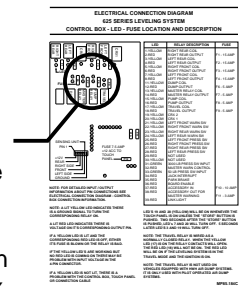

MP85.184C

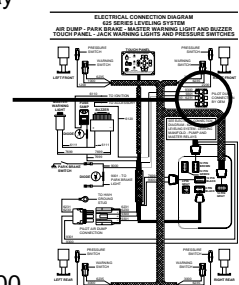

MP85.102A

625 TROUBLE SHOOTING STEPS

MANUAL OPERATION

PART 7. THE PUMP WILL NOT RUN OR RUNS ERRATICALLY WHEN AN UP ARROW (EXTEND) BUTTON IS PUSHED. THE ON LIGHT IS ON.

1. If the pump will not run when one or more UP ARROWS are pushed but other UP ARROWS will run the pump, replace the touch panel.
2. Check LEDs 13 (YELLOW), 14 (RED), 15 (YELLOW) and 16 (RED) while an UP ARROW is being pushed. All four LEDs should be lit. If all four LED's are lit, proceed to #3. **SEE: MP85.184C**

- a. **If either yellow LED is not lit**, replace the control box. If both yellow LEDs are lit, both red LEDs should be lit. (Check LEDs while pushing an UP ARROW)
- b. **If red LED 14 is not lit, check fuse F7.** If F7 is OK, replace the control box. If F7 is blown, the 8500 wire going to the master relay is shorted to ground or the master relay is bad. Wire 8500 is in pin 1 in the 12 pin brown connector on the back of the control box. Disconnect this wire from the master relay, replace the fuse and retry. If the fuse only blows with the 8500 wire connected to the master relay, the master relay is bad. **SEE: MP85.102K**
- c. **If red LED 16 is not lit, check fuse F8.** If F8 is OK, replace the control box. If F8 is blown, the 8600 wire going to the pump relay is shorted to ground or the pump relay is bad. Wire 8600 is on pin 12 in the 12 pin brown connector on the back of the control box. Disconnect this wire from the pump relay, replace the fuse and retry. If the fuse only blows with the 8600 wire connected to the pump relay, the pump relay is bad. **SEE: MP85.102K**

3. LEDs 13 (YELLOW), 14 (RED), 15 (YELLOW) and 16 (RED) are lit when an UP ARROW is being pushed. The problem is with the relays or the pump motor. **SEE: MP85.184C**

IMPORTANT: THE DEFINITION OF POWER IS 10.0 VOLTS OR MORE AT THE MASTER AND PUMP RELAYS WITH LEDs 13, 14, 15 AND 16 ON.

- a. Terminals 1, 2, 3, 4, 5, 6 and 9 should all have power when above LEDs are lit. Terminals 7 and 8 should be connected to the ground stud on the side of the pump. Make sure all terminals are tight and that the wires, ring terminals and the relay terminals are free of corrosion. **SEE: MP85.1035**
- b. If terminal 1 has no power, the problem is the 8500 wire or it's connections to the control box or to the master relay. **SEE: MP85.1035**
- c. If terminal 2 has no power, the problem is the battery cable from the battery supply or it's connections to the battery supply or to the master relay. **SEE: MP85.1035**
- d. If terminals 1 and 2 have power, check terminal 8 for ground. If ground is not present, the problem is the white ground wire or it's connections to the ground stud or to the master relay. **SEE: MP85.1035**
- e. If terminals 1 and 2 have power and terminal 8 has a ground, check terminal 3 for power. If there is no power on terminal 3, replace the master relay. **SEE: MP85.1035**
- f. If terminals 1,2 and 3 have power, check terminal 4. If terminal 4 has no power, the problem is the short cable between terminals 3 and 4 or it's connection to these terminals. **SEE: MP85.1035**
- g. If terminal 4 has power, check terminal 5 for power. If terminal 5 has no power, the problem is the 8600 wire or it's connections to the control box or to the pump relay. **SEE: MP85.1035**
- h. If terminal 5 has power, check terminal 7 for ground. If a ground is not present, the problem is the white ground wire or it's connections to the ground stud or to the pump relay. **SEE: MP85.1035**
- i. If terminal 5 has power and terminal 7 has a ground, check terminal 6 for power. If terminal 6 does not have power, replace the pump relay. **SEE: MP85.1035**
- j. If terminal 6 has power, check terminal 9 on the pump motor. If terminal 9 has no power, the problem is the short cable between the pump relay and the pump motor or it's connections. If terminal 9 has power, make sure the power unit assembly has a good frame mounting. The pump motor is internally grounded and the mounting of the assembly supplies the ground for the motor. Make sure the stud on the pump motor is tight. If all connections, mountings and wires are OK, replace the pump motor. **SEE: MP85.1035**

4. The pump runs erratically or slowly. Review number 3 of PART 7.

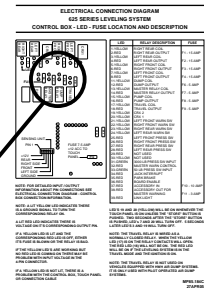

MP85.184C

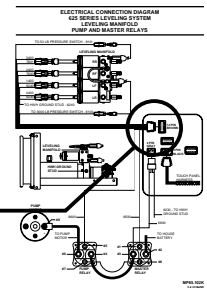

MP85.102K

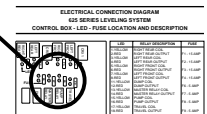

MP85.184C

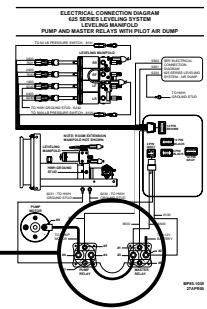

MP85.1035

625 TROUBLE SHOOTING STEPS

MANUAL OPERATION

PART 8. WHEN PUSHING ANY UP ARROW (EXTEND) BUTTON, NO JACKS WILL EXTEND, THE PUMP RUNS UNDER A LOAD.

1. The shuttle valve must shift and the control box must see the 50 p.s.i. manifold pressure switch before the control box will allow any solenoid valves to open.

IMPORTANT: Check the number on the program chip on the board in the control box. (See MP85.185J) If the number on the chip is a -5 or greater number, the control box does not need to see the 50 P.S.I. pressure switch. If the chip number is a -5 or greater and the LED's in PART 8 step 1, are not working properly, replace the control box. After replacing the control box, check step 2. If the LED's in step 1 are working properly, proceed to PART 8 step 2b.

- a. Check yellow LEDs 19 and 20. If either LED is not lit, replace the control box. **SEE: MP85.184C**

- b. Check yellow LEDs 1 (right rear solenoid valve), 3 (left rear solenoid valve), 5 (right front solenoid valve) and 7 (right rear solenoid valve). If these LEDs are coming on when UP ARROWS are being pushed, the shuttle valve and the 50 p.s.i. switch are functioning properly. The red LEDs 2 (right rear solenoid valve), 4 (left rear solenoid valve), 6 (right front solenoid valve) and 8 (left front solenoid valve) should come on. The LEDs will come on with their respective UP ARROWS as follows:
FRONT UP ARROW LEDs 5 and 7 (YELLOW) and LEDs 6 and 8 (RED)
REAR UP ARROW LEDs 1 and 3 (YELLOW) and LEDs 2 and 4 (RED)
RIGHT SIDE UP ARROW LEDs 1 and 5 (YELLOW) and LEDs 2 and 6 (RED)
LEFT SIDE UP ARROW LEDs 3 and 7 (YELLOW) and LEDs 4 and 8 (RED) **SEE: MP85.184C**

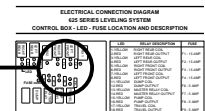

MP85.184C

- c. If the red LEDs are not coming on, the 6800 wire going to the 4 pin gray connector on the back of the control box may be the problem. Check fuses F1, F2, F3 and F4. If these fuses are blown, the solenoid valves may be bad. Whenever the system is on, the 6800 wire should have power on it. The 6800 wire connects to terminal 3 of the master relay. If there is no power on the 6800 wire, the problem is with the 6800 wire or it's connections to the control box or to the master relay. If the pump runs, the master relay is good. If the pump does not run, refer to PART 7, 2a. and 2b. If there is power on the 6800 wire, fuses F1, F2, F3 and F4 are OK and the red LEDs will not come on, replace the control box. **SEE: MP85.102K**

- d. If the red LEDs are coming on as necessary, this indicates there should be power on the appropriate output pins for the solenoid valves. There is most likely a problem with the 12 pin brown connector on the back of the control box the wires to the solenoid valves or their connections. **SEE: MP85.102K**

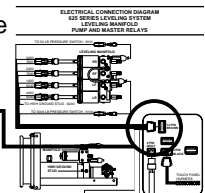

MP85.102K

2. If yellow LEDs 1,3,5, and 7 are not coming on, (or the yellow LEDs are coming on and the chip is -5 or greater) check LED 33 (GREEN). This LED should be on when the pump is running. This would indicate the control box is receiving a ground signal from the 50 p.s.i. switch on the manifold. **SEE: MP85.184C**

- a. If LED 33 is coming on and the yellow LEDs are not, replace the control box.

- b. If LED 33 is not coming on, the shuttle valve is not shifting, the 50 p.s.i. switch or its connections to the control box are bad, the control box is bad or the pump is bad. Open a valve release nut or T-handle **IMPORTANT: (SEE: MI91.999X)** and push an UP ARROW. If the jacks start to extend, the shuttle valve is shifting. The problem is the 50 p.s.i. switch, its connections to the control box or the control box. Proceed to c. If the jacks do not extend, check the pump pressure. The pump pressure should be a minimum of 3300 p.s.i. and a maximum of 3600 p.s.i. (if the pump develops at least 1000 p.s.i., the shuttle valve should shift.) If the pump pressure is low, check voltage at the power stud on the motor while the motor is running. Less than 9 volts at the motor while it is running may cause a pressure drop. If the pressure is OK, the problem is the shuttle valve. **SEE: MP65.600C**

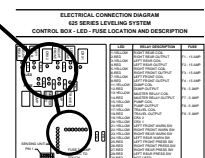

MP85.184C

- c. If the shuttle valve and the pump are OK, unplug the 50 p.s.i. switch and apply a ground on the 8101 wire going to the control box. If the green LED 33 comes on, replace the pressure switch. If the LED does not come on, unplug the 12 pin brown connector from the control box and apply a ground to pin 3 in the 12 pin brown control box connector. If LED 33 comes on, the problem is the 8101 wire or it's connections in the harness plugs. If LED 33 does not come on, replace the control box. **SEE: MP85.1035**

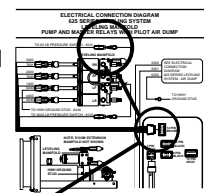

MP85.1035

**MI91.1232
22OCT07**

625 TROUBLE SHOOTING STEPS

MANUAL OPERATION

PART 9. WHEN PUSHING ANY UP ARROW (EXTEND) BUTTON, NO JACKS WILL EXTEND OR WILL EXTEND BUT NOT LIFT THE VEHICLE. THE PUMP IS FREE WHEELING UNDER NO LOAD.

1. The problem is most likely the shuttle valve or the pump. Voltage at the pump motor, while running, should not be less than 9.0 volts. If the vehicle is equipped with any HWH hydraulic room extensions, make sure none of the room extension solenoid valves are open.
 - a. Check the pump pressure. The pump pressure should be between 3300 p.s.i. and 3600 p.s.i. If the pump is not developing adequate pressure, replace the pump. If the pump pressure is OK, replace the shuttle valve. **SEE: MP65.600C**

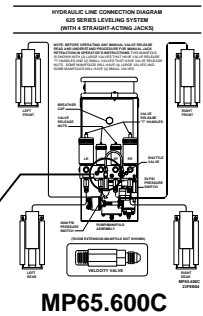

PART 10. WHEN PUSHING AN UP ARROW, THE CORRECT JACKS DO NOT EXTEND.

1. When testing the function of the UP ARROWS, always test all four UP ARROWS. Make sure that not only the correct jacks are operating but also other jacks are not moving. The problem most likely the plumbing or wire connections at the solenoid valves or control box. Check that the correct yellow and red LEDs are coming on for the UP ARROW that is being pushed. If the correct LEDs are not coming on, the control box is bad. Refer to the plumbing diagram and check that the correct jack is connected to the appropriate solenoid valve. Move hose connections as necessary. **SEE: MP65.600C**

NOTE: If the plumbing is incorrect, change the plumbing as necessary, DO NOT change the way the solenoid valves are wired. Do not remove hoses until all jacks are retracted. When re-tightening a hose end, tighten the hose end finger tight (snug) plus 1/4 turn. DO NOT OVER TIGHTEN.

If the plumbing is OK, refer to the wiring diagrams to check the wiring. The solenoid valve wires are in the 12 pin brown connector on the back of the control box as follows:

LEFT FRONT SOLENOID VALVE ---- WIRE 1400 ---- PIN 5
RIGHT FRONT SOLENOID VALVE -- WIRE 2400 ---- PIN 10
RIGHT REAR SOLENOID VALVE ---- WIRE 3400 ---- PIN 9
LEFT REAR SOLENOID VALVE ----- WIRE 4400 ---- PIN 8

Move the wires in the plug or at the solenoid valves as necessary. Retry the system. **SEE: MP85.1035**

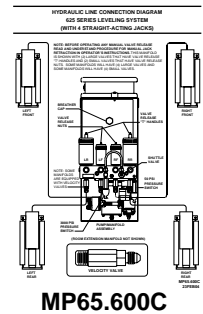

PART 11. ONE OR MORE JACKS WILL NOT EXTEND, OTHER JACKS ARE FUNCTIONING PROPERLY. THE PUMP IS RUNNING NORMALLY.

1. Check yellow LEDs 19 and 20. If either LED is off, replace the control box. Check the yellow and red LEDs for the jack(s) that will not extend. **SEE: MP85.184C & MP85.1035**
 - a. If the yellow LED is not coming on, replace the control box.
 - b. If the yellow LED is coming on but the red LED is not coming on, check the appropriate fuse. If the fuse is OK, replace the control box. If the fuse is blown, unplug the solenoid valve, replace the fuse and retry. If the fuse blows, the wires for the valve or their connections are shorted OR the control box is bad.
 - c. If the yellow and red LEDs are coming on, check for power between the two wires in the plug at the solenoid valve. If there is power at the plug, replace the solenoid valve. If there is no power at the plug, the problem is the wires or their connections. The solenoid valve wires are in the 12 pin brown connector on the back of the control box. Wiring for the solenoid valves is as follows:

LEFT FRONT VALVE ----- POWER ----- WIRE 1400 ----- PIN 5
GROUND --- WHITE WIRE TO GROUND STUD
RIGHT FRONT VALVE --- POWER ----- WIRE 2400 ----- PIN 10
GROUND --- WIRE 7600 ----- PIN 6
RIGHT REAR VALVE ----- POWER ----- WIRE 3400 ----- PIN 9
GROUND --- WIRE 7601 ----- PIN 7
LEFT REAR VALVE ----- POWER ----- WIRE 4400 ----- PIN 8
GROUND --- WHITE WIRE TO GROUND STUD

NOTE: Low voltage can be a problem. With the valve plugged in and turned on, there should be a minimum of 9.0 volts between the two wires for the valve. If there is less than 9.0 volts, low volts may be the problem

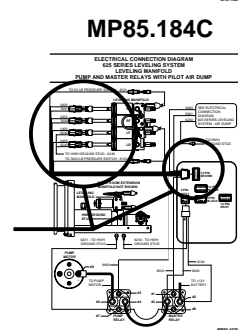
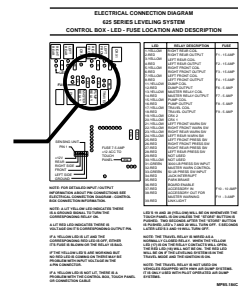
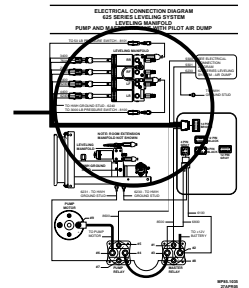

625 TROUBLE SHOOTING STEPS

MANUAL OPERATION

PART 12. ONE OR MORE JACKS WILL NOT STAY DOWN AFTER BEING EXTENDED TO THE GROUND.

1. If a jack retracts more than 1/2 inch after being extended to the ground, if there are no visible leaks, replace the solenoid valve. To check this, extend the jacks to the ground and lift the coach slightly. Allow the vehicle to set on the jacks for 10 minutes before marking the rods. Mark the rods of the jacks with a piece of tape about 1 inch down from the barrel of the jack. Monitor this to see how far the jack will retract. Extreme changes in temperature can affect the movement of the jacks.
2. If a jack retracts quickly after being extended, retry and push the OFF button as soon as the UP ARROW is released. If the jack continues to retract, replace the solenoid valve. If the jack stops retracting, the control box is most likely the problem.

PART 13. A RED WARNING LIGHT ON THE TOUCH PANEL WILL NOT TURN ON WHEN IT'S JACK IS EXTENDED 1/4 TO 1/2 INCH OR MORE.

1. Each jack has a two wire magnetic warning switch. The switch is located on top of the jack. There is a magnet inside the jack. The contacts of the switch close when the jack has extended approximately 1/4 to 1/2 inch. The contacts open when the jack is retracted. The white wire in the harness supplies a ground to the switch and the black wire carries a ground signal to the control box when the jack is extended and the switch contacts are closed. There is a yellow LED in the control box for each warning switch input. A lit yellow LED indicates the warning switch is on. The warning switch LEDs and inputs are:
LEFT FRONT ----- LED 21 ----- PIN 3 ----- WIRE 1000
RIGHT FRONT --- LED 22 ----- PIN 4 ----- WIRE 2000
RIGHT REAR ----- LED 23 ----- PIN 9 ----- WIRE 3000
LEFT REAR ----- LED 24 ----- PIN 10 --- WIRE 4000
SEE: MP85.184C

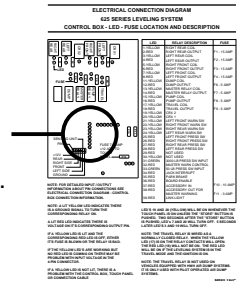

MP85.184C

The warning switch inputs are in the 12 pin gray connector on the back of the control box.
SEE: MP85.102A

- a. The warning switch LED in the control box is coming on but the warning light on the touch panel is not coming on. The problem is most likely the control box but could be the touch panel.
- b. The warning switch LED in the control box is not coming on. Unplug the 12 pin connector from the back of the control box. Ground the appropriate pin in the box connector. If the warning switch LED does not come on, replace the control box. If the warning switch LED comes on, the problem is the wire harness or the jack warning switch. Plug the 12 pin connector back into the control box.
SEE: MP85.102A
- c. If the problem is the wire harness or warning switch, unplug the warning switch at the jack. Short the two pins in the harness plug together. If the warning switch LED comes on, replace the warning switch. If the warning switch LED does not come on, short the black warning switch wire in the harness to ground. If the warning switch LED does not come on, the problem is the black wire or it's connections. If the warning switch LED comes on, the problem is the white ground wire. **SEE: MP85.102A**

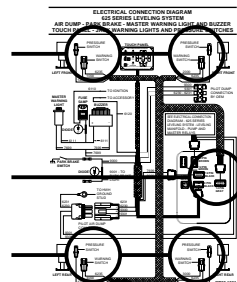

MP85.102A

PART 14. THE MASTER WARNING LIGHT AND BUZZER WILL NOT COME ON WHEN A TOUCH PANEL WARNING LIGHT IS ON.

1. The master "JACKS DOWN" warning light and buzzer are controlled by one wire from the control box. If one works but the other does not, the problem would only be with the component that is not working.
2. The LED 32 should be on if any warning switch LED is on. **SEE: MP85.184C**
 - a. If LED 32 is not on and any warning switch LED is on, replace the control box.
 - b. If LED 32 is on, unplug the 12 pin black connector from the control box and check pin 11 for a ground. If a ground is not present, replace the control box. **SEE: MP85.102A**
 - c. If there is a ground on pin 11 in the 12 pin black connector, the problem is the 7699 wire, the light, buzzer, their connections or the ignition power to the light and buzzer.
SEE: MP85.304R

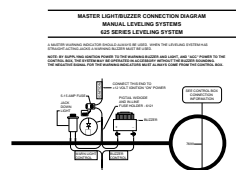

MP85.304R

**MI91.1252
28NOV07**

625 TROUBLE SHOOTING STEPS

MANUAL OPERATION

PART 15. ONE OR MORE JACKS WILL NOT RETRACT WHEN A DOWN ARROW (RETRACT) BUTTON IS PUSHED. SOME JACKS WILL RETRACT.

1. The pump should not run when a DOWN ARROW is pushed. If a pump runs when a DOWN ARROW is pushed, the control box or touch panel is the problem.
2. Open the valve release nut (small valve) 4 1/2 complete turns or the valve release T-handle (large valve) approximately 5 full turns counter-clockwise. **SEE: MP85.600C**
 - a. If the jack will not retract, the problem is the hose, velocity valve (if so equipped) or the jack. Slowly remove the hose from the jack. If the jack does not retract, replace the jack. If the jack starts to retract, tighten the hose and loosen the hose at the manifold. If the jack does not retract, there is a problem with the hose, such as a kink. If the jack retracts and the manifold is equipped with a velocity valve, the valve is most likely the problem. If there is no velocity valve, there may be a check valve or solenoid valve problem. Contact HWH technical service. **SEE: MP85.600C**
3. If the jack retracts when the valve is manually opened, the control box is most likely the problem. If the jack will extend, the valve and its connection to the control box should be OK.
 - a. Check the yellow and red LEDs for the jack that is not retracting. If the yellow LED is not coming on while the down arrow is being pushed, replace the control box. If the yellow LED is coming on, review PART 11, 1b and 1c. If a jack will extend, the solenoid valve and wiring should be OK when pushing a DOWN ARROW also. REMEMBER LOW VOLTAGE WILL CAUSE PROBLEMS. **SEE: MP85.184C**

CAUTION: DO NOT CRAWL UNDER ANY VEHICLE SUPPORTED ON THE LEVELING JACKS WITHOUT PROPERLY SUPPORTING THE FRAME OF THE VEHICLE SO IT CANNOT DROP WHEN THE FLUID IS RELEASED FROM A JACK.

PART 16. NO JACKS WILL RETRACT WHEN PUSHING ANY OF THE DOWN ARROW (RETRACT) BUTTONS.

1. Check the yellow and red LEDs for the solenoid valves while pushing the DOWN ARROW buttons. If the yellow LEDs are not coming on, the problem is the control box or touch panel. If the red LEDs are not coming on, the master relay may have a problem, refer to PART 7. If the yellow and red LEDs are coming on, the problem is most likely the shuttle valve. Turn the valve release nuts (small valves) 4 1/2 complete turns (no more) or valve release T-handles (large valves) 5 full turns counterclockwise. If the jacks retract, the problem is the solenoid valves or their connections. If the jacks do not retract, replace the shuttle valve. **IMPORTANT:** Do not remove the shuttle valve until all solenoid valves are closed, electrically or manually. **SEE: MP85.184C & MP65.600C**

NOTE: Remember yellow LEDs 19 and 20 should be on whenever the touch panel is on except during the automatic retract mode. If LED 19 is not on, the right rear solenoid valve will not function. If LED 20 is not on, the right front solenoid valve will not function. If either LED 19 or 20 is not on, replace the control box. **SEE: MP85.184C**

PART 17. THE RED WARNING LIGHT FOR A JACK WILL NOT GO OUT WHEN THE JACK IS FULLY RETRACTED.

1. Check the yellow LED for the proper warning switch input in the control box. Number 21 is for the left front jack, 22 is for the right front jack, 23 is for the right rear jack and 24 is for the left rear jack. If the warning switch LED is not on, replace the control box. **SEE: MP85.184C**
2. If a warning switch LED is on, unplug the warning switch for the jack(s) that have a lit LED. If the LED(s) go out, the problem is the warning switch. **NOTE:** The magnet in the jack may be bad. If a new switch does not fix the problem, contact HWH customer service. If the LED stays on with the warning switch unplugged, unplug the 12 pin gray connector from the back of the control box. If the LED remains on, replace the control box. If the LED goes out, the warning switch wire(s) for the LED(s) that are on are shorted to ground. **SEE: MP85.102A**

NOTE: Make sure the white wires of the harness and warning switch are in the "A" pins of the Packard connectors. The black wires must be in the "B" pins of the connectors.

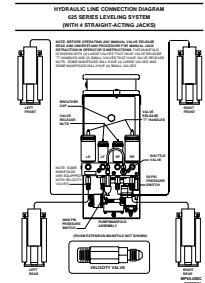

MP65.600C

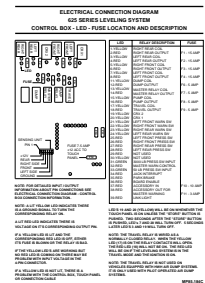

MP85.184C

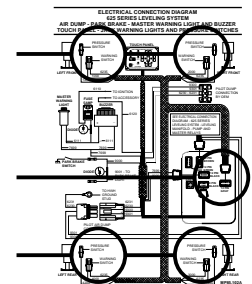

MP85.102A

625 TROUBLE SHOOTING STEPS

MANUAL OPERATION

PART 18. THE YELLOW LEVEL INDICATORS ON THE TOUCH PANEL ARE NOT FUNCTIONING PROPERLY.

A lit yellow level light indicates that side or end is low. When all of the yellow lights are out, the vehicle should be level. One or two yellow lights may be on at one time but opposing yellow lights should never be on. The sensing unit is located in the control box. Because the control box can be mounted with the clear Plexiglas cover pointing in any of four directions, the sensing unit must be programmed for direction and also the type of suspension, air or spring. Most systems that are installed by the vehicle manufacturer have a preprogrammed sensing unit. After market systems will most likely have a programmable sensing unit. Replacement control boxes will usually be a generic type with a programmable sensing unit. Replacement sensing units will be programmable. When replacing a control box or sensing unit, refer to instruction sheet ML31215 for detailed instructions for programming the sensing unit. No special tools are needed.

1. The yellow lights do not correspond to the position of the vehicle, such as the right side of the vehicle is low but the left side yellow level indicator light is on.
 - a. There are four yellow LEDs on the sensing unit board. These LEDs should correspond to the yellow level indicators on the touch panel. If they do not, the sensing unit is not programmed properly. If the sensing unit is programmable, reprogram the sensing unit. If the sensing unit is not programmable, the position of the complete power unit assembly will have to be changed. If this is not reasonable to do, the sensing unit will have to be replaced with a programmable one. **SEE: MI91.1152 & MP45.271M**
 - b. If the sensing unit LEDs and the touch panel lights correspond, the sensing unit may be out of adjustment. There is an adjustment nut and screw on the outside of the control box for the sensing unit. Refer to the maintenance sheet for sensing unit adjustment procedures. Minor, gentle movement of the adjustment nut and screw work best. **SEE: MP45.271M**
2. No yellow level indicators on the touch panel will come on. The yellow LEDs on the sensing unit board are NOT working.
 - a. Unplug the sensing unit. Use a test light to check pin 1 on the board for +12 volts and pin 6 for a ground. If these pins are OK, replace the sensing unit. If either pin is not working, replace the control box.
3. No yellow level indicators on the touch panel will come on. The yellow LEDs on the sensing unit board ARE working.
 - a. Unplug the sensing unit. Use a test light to ground pins 2 (rear), 3 (right side), 4 (front) and 5 (left side). If the appropriate yellow lights on the touch panel come on, replace the sensing unit. If the appropriate yellow lights do not come on, replace the control box.
4. Yellow level indicator lights on the touch panel will not go out or opposing yellow indicator lights are on.
 - a. Compare the yellow LEDs on the sensing unit board to the yellow indicators on the touch panel. If the LEDs on the sensing unit board match the yellow level lights on the touch panel, replace the sensing unit. If the LEDs on the sensing unit board DO NOT match the yellow lights on the touch panel, replace the control box. **SEE: MI91.1152 & MP45.271M**

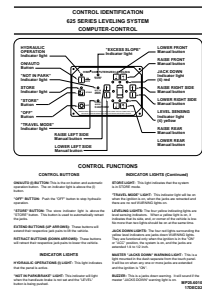

MI91.1152

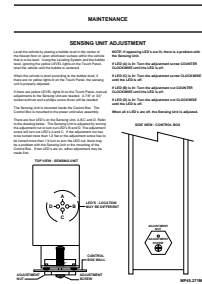

MP45.271M

625 TROUBLE SHOOTING STEPS

AUTOMATIC LEVELING

It is assumed at this point the different components of the leveling system are all functioning properly in the manual mode. It is also assumed the level sensing unit is properly adjusted with the yellow level indicator lights on the touch panel off and the vehicle level.

1. With the ignition on (or in ACC.) push the LEVEL (L or HYD) button. The ON light will be lit.
2. Push the LEVEL button a second time. The On light will start to flash.
3. If the vehicle is equipped with an air suspension, the air will start to dump at this time. The air will dump for approximately 25 seconds before the leveling sequence starts.
4. The pump will come on and the system will start to extend jacks to level the vehicle. The system will start by extending jacks to turn a lit side yellow level indicator off first.
5. The appropriate red jack down warning light on the touch panel will come on as the jacks extend 1/4 to 1/2 inch. If the ignition is in the ON position, the master warning light and buzzer will come on.
6. The system will extend jacks as necessary until the yellow level lights are all off. When all of the level lights are off, there will be a short (2 seconds) pause before the system goes into the stabilize mode. Once in the stabilization mode, yellow level lights will not come back on.
7. STABILIZE MODE: Stabilize mode is when any jack not used to level the vehicle is extended to the ground. Jacks that are used to stabilize the vehicle should lift the vehicle at least 3/4 to 1 inch after the jack touches the ground. Each jack has a pressure switch mounted on it. The pressure switch is a normally open, one wire switch. The switch closes when the jack touches the ground and lifts the vehicle 3/4 to 1 inch. This sends a ground signal to the control box. The control box will then shut off the solenoid valve for that jack.

NOTE: If either pressure switch for the front jacks is not on, both front solenoid valves will remain on until both front pressure switches are on.

8. When all four jack pressure switches are on, the pump will shut off and the ON light along with all other touch panel lights will turn off. The leveling sequence is over.

DIAGNOSTICS

PART 1. IF ANY PROBLEMS OCCUR DURING STEPS 1 THROUGH 6 REVIEW THE DIAGNOSTICS IN THE MANUAL OPERATION DIAGNOSTIC SECTION OF THIS MANUAL.

PART 2. DURING THE STABILIZE MODE ONE OR MORE JACKS WILL NOT EXTEND TO THE GROUND AND LIFT THE VEHICLE 3/4 TO 1 INCH.

1. If jacks that are stabilizing extend but don't quite reach the ground or don't lift enough, the pressure switch may need adjusted. Remove the rubber boot, loosen the jam nut and turn the threaded portion clockwise 1/4 turn and retry. Repeat this as necessary. If adjusting the switch does not work, replace the switch.
2. If a jack does not extend at all, check the red LED in the control box for that pressure switch.

SEE: MP85.184C

- a. If the red LED is not on, retry that jack manually. If the jack will extend manually but not in stabilize and the red LED is not on, replace the control box. If the jack will not extend manually, review PART 11 of the MANUAL OPERATION diagnostic section of this manual.

- b. If the red LED is on, the jack pressure switch is stuck on, the wire in the harness is shorted to ground or the control box is bad. Unplug the pressure switch and check the LED. If the red LED goes out, replace the pressure switch. If the red LED is still on, unplug the 12 pin gray connector from the control box. If the red LED goes out, the wire in the harness is shorted to ground. If the red LED stays on, replace the control box. The pressure switch LEDs and wires are as follows:
LEFT FRONT PRESSURE SWITCH ----- LED 25 ----- WIRE 1200 ----- PIN 5
RIGHT FRONT PRESSURE SWITCH --- LED 26 ----- WIRE 2200 ----- PIN 6
RIGHT REAR PRESSURE SWITCH ----- LED 27 ----- WIRE 3200 ----- PIN 7
LEFT REAR PRESSURE SWITCH ----- LED 28 ----- WIRE 4200 ----- PIN 8

SEE: MP85.184C & MP85.102A

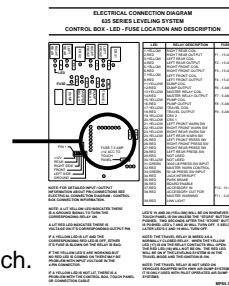

MP85.184C

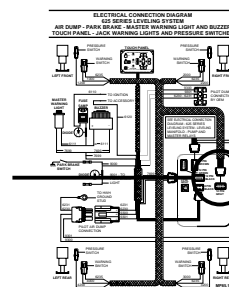

MP85.102A

MI91.1282
31MAY05

625 TROUBLE SHOOTING STEPS

AUTOMATIC LEVELING

PART 3. DURING THE STABILIZING MODE ONE OR MORE JACKS LIFTS THE VEHICLE TO HIGH.

1. If a jack lifts the vehicle more than 1 inch but does not extend completely, the pressure switch may need to be adjusted. Remove the rubber boot, loosen the jam nut and turn the threaded portion counterclockwise 1/4 turn and retry. Repeat as necessary. If adjusting the switch does not work, replace the pressure switch.
2. If a jack continues to extend and the pump will not shut off, check the red LED in the control box for that pressure switch. **SEE: MP85.184C**

NOTE: If both red LEDs for the front pressure switches are not on, both front jacks will continue to extend.

- a. If the red LEDs for the front pressure switches are on and the front jacks continue to extend, replace the control box. If a rear pressure switch LED is on and its jack continues to extend, replace the control box.
- b. If a jack is on the ground lifting the vehicle and its pressure switch LED is not on, the pressure switch is bad, the wire is bad or the control box is the problem. Unplug the pressure switch and ground the harness pin for that wire. If the red LED comes on, replace the pressure switch. If the red LED does not come on, unplug the 12 pin gray connector from the control box. Ground the appropriate pin in the box receptacle. If the LED come son, the harness wire or its connections are bad. If the red LED does not come on, replace the control box. **SEE: MP85.184C & MP85.102A**

EXCESS SLOPE: EXCESS SLOPE IS WHEN ONE OR TWO JACKS REACH FULL EXTENSION AND ONE OR MORE YELLOW LEVEL LIGHTS REMAIN ON. WHEN THIS HAPPENS, THE 3000# PRESSURE SWITCH ON THE MANIFOLD CLOSSES SENDING A GROUND SIGNAL TO THE CONTROL BOX. THE PUMP WILL SHUT OFF, THE SYSTEM WILL NOT STABILIZE AND THE TOUCH PANEL WILL TURN OFF WITH THE "EXCESS SLOPE" LIGHT REMAINING ON. THE "EXCESS SLOPE" LIGHT WILL BE ON WHENEVER THE IGNITION IS ON UNTIL THE JACKS ARE COMPLETELY RETRACTED WITH THE "STORE" BUTTON OR THE PARK BRAKE IS RELEASED.

1. If the system will not go EXCESS SLOPE, the pressure switch is not working, the control box is bad, the pressure wire (8100) is bad or the pump is the problem. The green LED 31 in the control box should be on when the 3000# pressure switch comes on.
 - a. Unplug the 3000# switch and ground wire 8100. If LED 31 does not come on, unplug the 12 pin brown plug from the control box and ground pin 2 in the control box receptacle. If LED 31 does not come on, replace the control box. If the LED comes on, the problem is the wire 8100 or its connections. **SEE: MP85.1035 & MP85.184C**
 - b. If LED 31 comes on when wire 8100 is grounded, retry automatic leveling with wire 8100 grounded. Make sure a yellow level indicator light is lit. The pump should shut off and the "EXCESS SLOPE" light should come on several seconds after the pump starts running. If the pump continues to run, the problem is the control box. If the panel shows "EXCESS SLOPE" the problem is the pressure switch or the pump pressure is not high enough. Check the pump pressure. The pressure should be between 3300# and 3600#. If the pump pressure is too low, replace the pump. If the pump pressure is OK, replace the 3000# pressure switch.

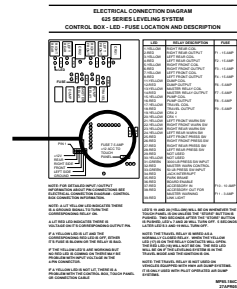

MP85.184C

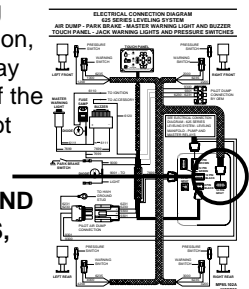

MP85.102A

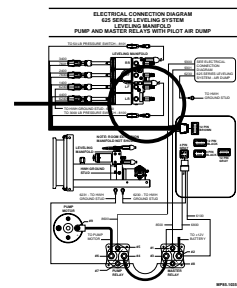

MP85.1035

AUTOMATIC STORE (RETRACT) SEQUENCE

1. The ignition must be in the ON or ACC. position. If the ignition is in the ON position, the master warning light and buzzer will be on while the jacks are retracting.
2. Push the "STORE" button. The touch panel does not have to be on.
3. Vehicles equipped with an air suspension should start to return to ride height at this time.
4. The two front jacks will start to retract.
5. Five (5) seconds later the rear jacks will start to retract.
8. The red warning lights on the touch panel will go out as each jack retracts within 1/4 to 1/2 inch.
7. Six minutes after the last red warning light goes out, the touch panel will turn off.

NOTE: If one or more jacks will not retract and/or a red jack down warning light will not go out, the system will stay in the STORE mode for thirty (30) minutes from the time the "STORE" button was pushed then the system will turn off. The "TRAVEL MODE" light will not be on.

625 TROUBLE SHOOTING STEPS

SERIES/PARALLEL OPERATION OF SOLENOID VALVES

During manual leveling, manual retract and automatic leveling, the solenoid valves are operated independently of each other. That is, each valve has its own ground and switched +12 volts. The ground wires for the right front (7600) and right rear (7601) solenoid valves are routed to the control box and through CRX1 (7600) and CRX2 (7601) to ground. The ground wires for the left front and left rear are white wires that are attached to the ground stud on the side of the pump. When the "STORE" button is pushed, the solenoid valves for the two front jacks are turned on first. The solenoid valves for the rear jacks are turned on five (5) seconds later.

Two (2) seconds after the front valves are turned on, the left front relay (LED 7) is turned off along with the CRX1 relay (LED 20). Current is routed through the right front valve coil, back to the control box on wire 7600, out to the left front valve, then through the left front valve coil to find a ground at the ground stud. The two front valves are now wired in series. Five (5) seconds after the front valves are turned on, the two rear valves are turned on. Two (2) seconds after the two rear valves are turned on, the left rear relay (LED 3) is turned off along with the CRX2 relay (LED 19). Current is routed through the right rear valve coil, back to the control box, out to the left rear valve on wire 7601, then through the left rear valve coil to find a ground at the ground stud. The two rear valves are now wired in series. Approximately seven (7) seconds after the "STORE" button is pushed, the two front valves are operating in series and the two rear valves are operating in series. When checking voltage at the solenoid valves in the automatic STORE mode, seven (7) seconds after the "STORE" button is pushed, the voltage to each valve should be in the 5 to 6 volt range.

The proper sequence of the LEDs for the four valve relays along with CRX1 and CRX2 is as follows:

1. Push "STORE", LEDs 5, 6, 7, 8, 19 and 20 will come on.
2. Two (2) seconds later, LEDs 7 and 20 will turn off.
3. Three (3) seconds later, LEDs 1, 2, 3 and 4 will turn on.
4. Two (2) seconds later, LEDs 3 and 19 will turn off.

SEE: MP85.184C

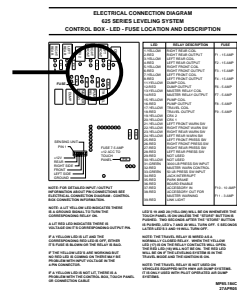

DIAGNOSTICS FOR THE AUTOMATIC STORE SEQUENCE

PART 1. ONE OR MORE JACKS WILL NOT RETRACT AFTER THE "STORE" BUTTON IS PUSHED.

MP85.184C

1. If at least one jack retracts properly but others will not review PART 15 of the manual operation section.
2. If no jacks will retract, review PART 16 of the manual operation section.

PART 2. THE LEFT FRONT OR THE LEFT REAR START TO RETRACT BUT STOP AFTER SEVERAL SECONDS. THEY RETRACT PROPERLY IN THE MANUAL MODE.

1. If the left front jack starts to retract but stops, replace the right front solenoid valve.
2. If the left rear jack starts to retract but stops, replace the right rear solenoid valve.

PART 3. ONE OR MORE RED WARNING LIGHTS ON THE TOUCH PANEL WILL NOT TURN OFF WHEN THE JACKS ARE FULLY RETRACTED.

1. Review PART 17 of the manual operation section.

PART 4. VEHICLES WITH AIR SUSPENSION WILL NOT RETURN TO RIDE HEIGHT

Vehicles equipped with HWH air dump System

1. Make sure there is at least 100 psi of air in the vehicle air tanks. The vehicle engine should be running. Make sure the touch panel LEVEL Mode light is OFF.
 - a. If air is not exhausted from the dump valves, the problem is in the vehicle suspension, most likely a height control valve.
 - b. If air is exhausting from the dump valve(s) unplug the dump valve(s). If the air continues to exhaust from the valve(s), replace the valve(s).
2. If the air stops exhausting from the dump valve(s) when they are unplugged, either the 9300 wire in the harness is shorted to +12 voltage or the control box is bad. Unplug the 12 pin brown connector from the back of the control box. Make sure the ignition is on and the "STORE" light on the touch panel is on. Check the red LED 12.
 - a. If the LED is on, replace the control box.
 - b. If the LED is not on, the problem has to be in the harness.

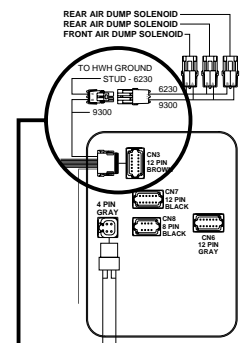

MP85.1045

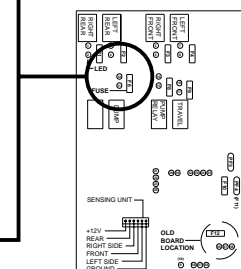

MP85.184C

**MI91.1302
03AUG09**

625 TROUBLE SHOOTING STEPS

AUTOMATIC STORE (RETRACT) SEQUENCE

Continued PART 4. VEHICLES WITH AIR SUSPENSION WILL NOT RETURN TO RIDE HEIGHT

Vehicles equipped with a pilot air dump system

1. Make sure there is at least 100 psi of air in the vehicle air tanks. The ignition must be on. Make sure the STORE light is ON. Check the YELLOW (17) LED and the RED (18) LED for travel. Only red LED (18) should be lit. If red LED (18) is lit, check for +12 volts between the white ground wire and the 9301 wire in the HWH 4 pin UML plug.
 - a. If power is not present, the problem is either the white ground wire, the 9301 wire or their connections. If power is present, the problem is with the chassis equipment or harness. Contact the vehicle manufacturer for assistance.
 - b. **If red LED 18 is not lit**, check fuse F9. If F9 is not blown, check red LED 37. If LED 37 is off, there is no ignition power to the control box. Recheck PART 4 of this manual. If red LED 37 is on, replace the control box.
 - c. **If F9 is blown**, unplug the 4 pin UML connector from the pilot dump harness. Replace the fuse and retry. If the fuse blows, the problem is probably the harness. If the fuse does not blow, the problem is the suspension equipment. Contact the vehicle manufacturer for assistance.
 - d. **If yellow LED (17) is lit**, replace the control box.

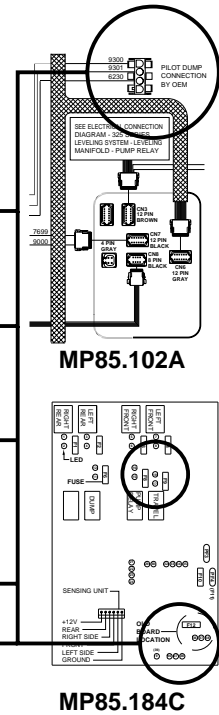

MANUAL VALVE RELEASE PROCEDURES

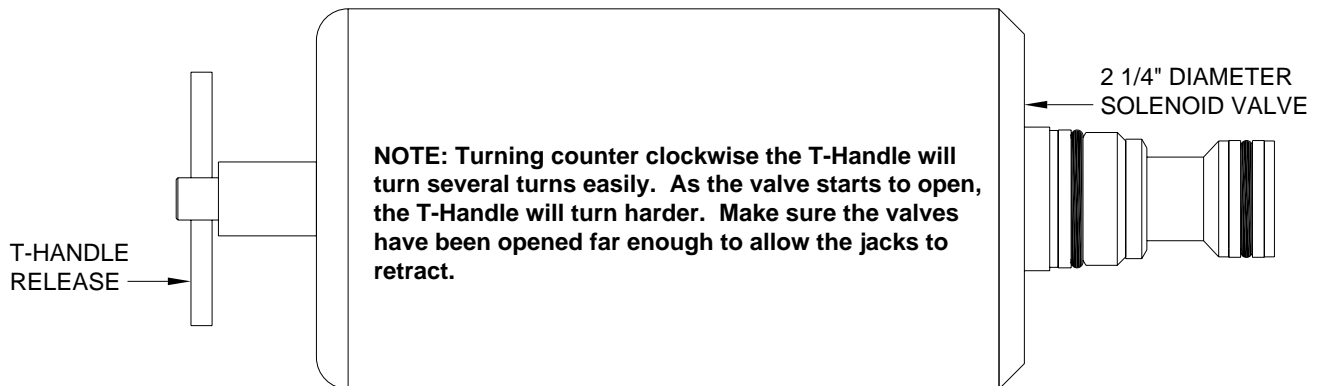
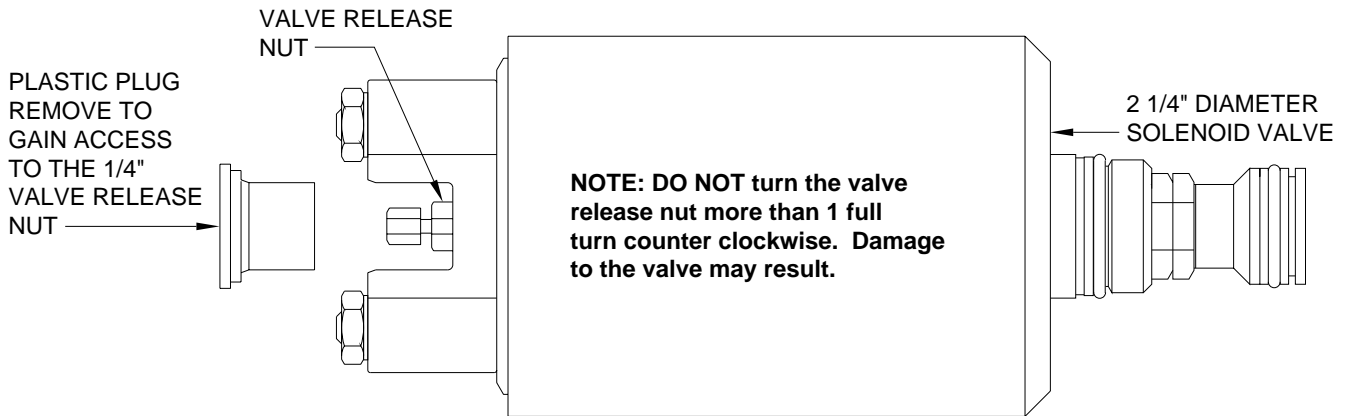
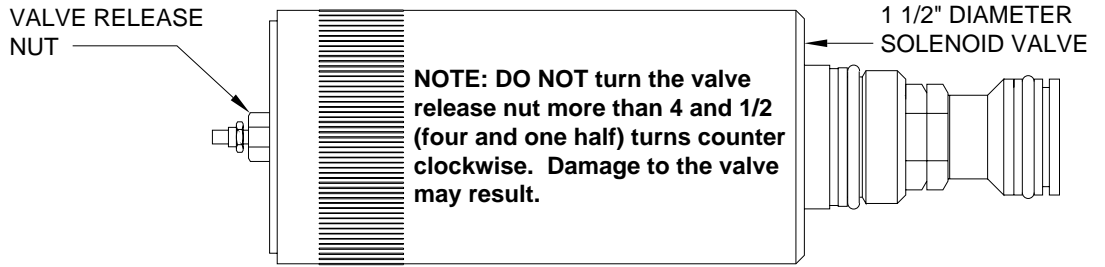

SENSING UNIT MAINTENANCE/SERVICE

SENSING UNIT ACCURACY TOLERANCE

The sensing unit has an accuracy tolerance of ± 5.4 inches front to rear and ± 1 inch side to side on a 36 foot vehicle. Typical leveling results will be better.

SENSING UNIT ADJUSTMENT

To adjust the sensing unit, first the vehicle must be level. Either position the vehicle on a level surface or use the leveling system to manually level the vehicle. It is recommended to use the vehicle trim line to determine level. An alternative would be to use a small bubble level. If using a bubble level, the level should be placed on a flat surface close to the mounting location of the control box/sensing unit.

With the vehicle level, if there are no yellow light lit on the Touch Panel, the sensing unit is properly adjusted. If there are yellow LEVEL lights lit on the Touch Panel, manual adjustments to the Sensing Unit are needed. A Phillips screw driver or sockets w/driver or box end wrenches of 7/8, 3/4, 1/2, 5/16 or 1/4 sizes will be needed.

The Sensing Unit is mounted inside the Control Box. The Control Box is mounted to the power unit/valve assembly.

There are four LED's on the Sensing Unit, A,B,C and D. Refer to the drawing below. The Sensing Unit is adjusted by turning the adjustment nut to turn out LED's B and D. The adjustment screw will turn out LED's A and C. If the adjustment nut has to be turned more than 1/2 flat or the adjustment screw has to be turned more than 3/4 turn to turn the LED out, there may be a problem with the Sensing Unit or the mounting of the Control Box. If two LED's are on, it is best to make the B-D adjustments first, then hold the adjustment nut from moving while making the A-C adjustment.

NOTE: If opposing LED's are lit, there is a problem with the Sensing Unit.

If LED (A) is lit: Turn the adjustment screw COUNTER CLOCKWISE until the LED is off.

If LED (C) is lit: Turn the adjustment screw CLOCKWISE until the LED is off.

If LED (B) is lit: Turn the adjustment nut COUNTER CLOCKWISE until the LED is off.

If LED (D) is lit: Turn the adjustment nut CLOCKWISE until the LED is off.

IMPORTANT: When all 4 LED's are off, move the vehicle to an unlevel position so one or two yellow lights are on. Level the vehicle according to the yellow LEVEL lights. Recheck the level. If more adjustment is needed, DO NOT try to adjust the sensing unit until the yellow level lights go out, instead just "tweak" the sensing unit, ignoring the LED's on the sensing unit.

Example: After the initial adjustment and releveling the vehicle, the front is still low. This means the front yellow level light is turning off too soon. Determine which sensing unit light is the front light, A-B-C or D. Move the adjustment for that light very, very, slightly in the OPPOSITE direction that is given in the above instructions for LED's A, B, C, and D. This will allow the front yellow light to stay on slightly longer to bring the front up more. Again, unlevel the vehicle then relevel the vehicle using the yellow level lights on the touch panel. Recheck with a level. Repeat the "tweaking" process until the system levels the vehicle properly.

TOP VIEW - SENSING UNIT

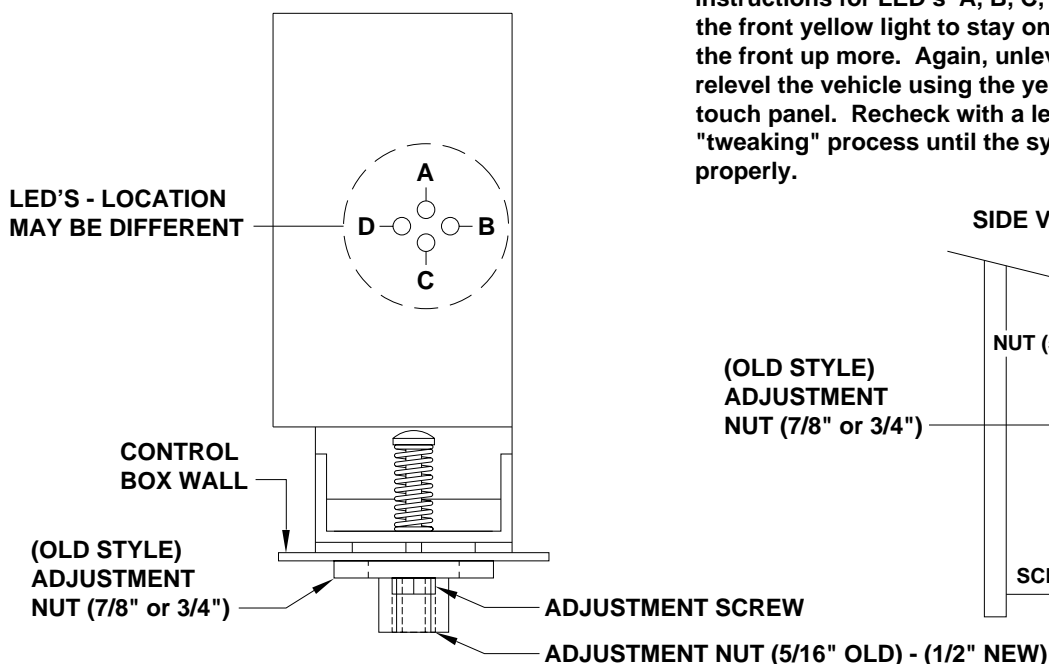

SIDE VIEW - CONTROL BOX

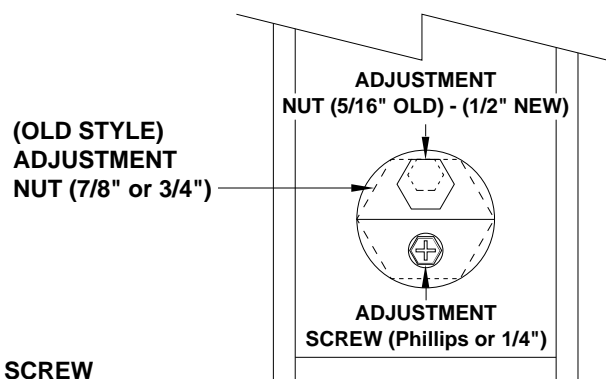



**READ
INSTRUCTIONS
THOROUGHLY
BEFORE
PROCEEDING**

INSTRUCTION SHEET - JUMPER PLACEMENT FOR 325 AND 625 AFTER MARKET INSTALLATIONS OR ELECTRONIC SENSING UNIT REPLACEMENT

IMPORTANT: 325 AND 625 ELECTRONIC SENSING UNITS USED IN AFTER MARKET INSTALLATIONS OR REPLACEMENT SITUATIONS ARE PROGRAMMABLE. DURING INSTALLATION OF A SYSTEM OR REPLACEMENT OF AN ELECTRONIC SENSING UNIT DO NOT ASSUME THAT THE SENSING UNIT JUMPERS ARE PRE-SET. THE MOUNTED ORIENTATION OF THE CONTROL BOX ASSEMBLY AND THE SUSPENSION TYPE MUST BE ESTABLISHED IN ORDER TO SET THE JUMPERS AS NEEDED TO PROGRAM THE SENSING UNIT TO THE COACH.

JP1 AND JP2 - CONTROL BOX ORIENTATION (Page 1 of 2)

MOVE JUMPERS JP1 AND JP2 ACCORDING TO THE ORIENTATION OF THE CONTROL BOX. USE THE DRAWINGS PROVIDED TO DETERMINE WHICH APPLICATION IS FOR THE ORIENTATION OF YOUR CONTROL BOX.

FOR SHIPPING PURPOSES THE (4) JUMPERS ARE SLID ONTO ONE SIDE OF JP1 THROUGH JP4. MOVE ONLY THE JUMPERS NEEDED TO DETERMINE ORIENTATION AND SUSPENSION. LEAVING THE REMAINING JUMPERS AS THEY ARE SHIPPED WILL NOT CAUSE PROBLEMS.

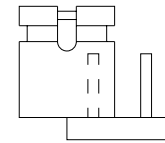
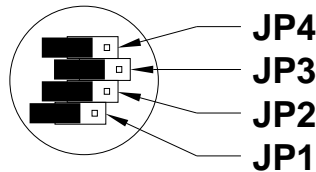

SHIPPED POSITION

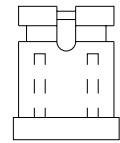

MOVED POSITION

THE FOLLOWING DRAWINGS SHOW THE SENSING UNIT, INSIDE THE CONTROL BOX, AS VIEWED WHEN LOOKING DOWN FROM THE TOP OF THE CONTROL BOX. REMOVE THE RUBBER RING AND PLASTIC COVER ONLY IF NEEDED. THE RING AND COVER MUST BE REINSTALLED.

FRONT OF VEHICLE

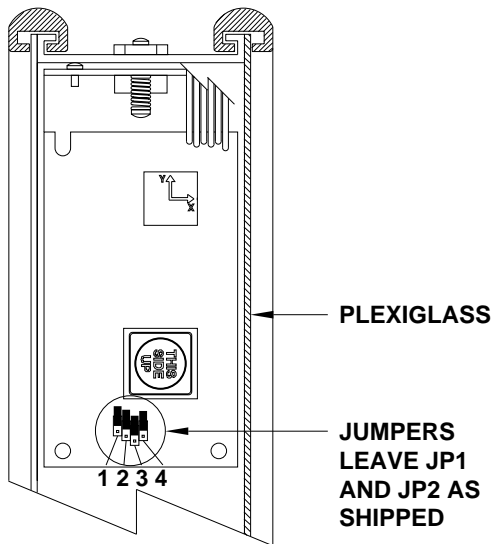

FRONT OF VEHICLE

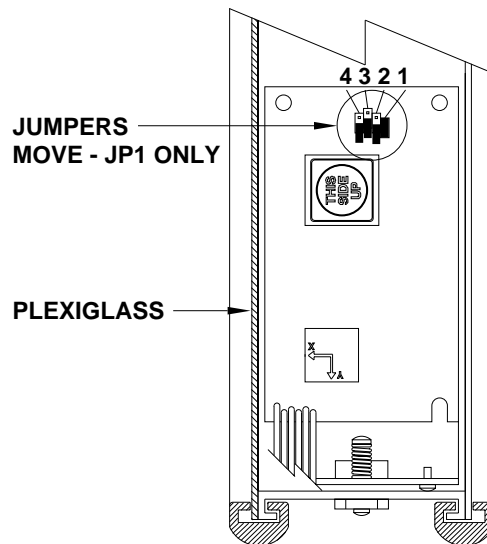

FRONT OF VEHICLE

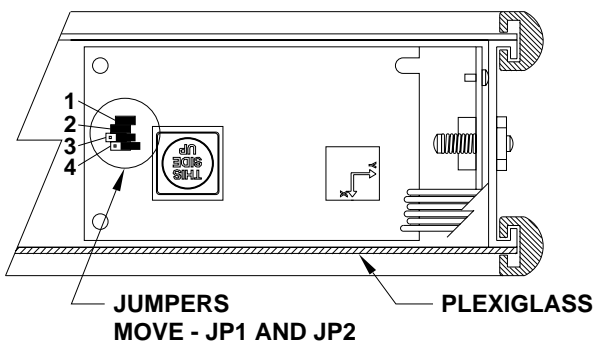

FRONT OF VEHICLE

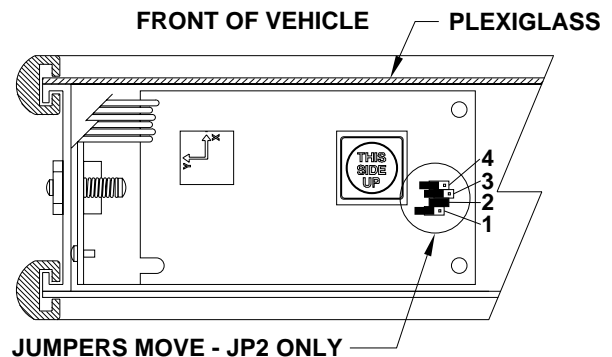

NOTE: AFTER MOVING THE JUMPERS, REMOVE AND REAPPLY +12 POWER FOR THE CONTROL BOX. THIS WILL "RE-BOOT" THE SENSING UNIT.

**MP45.272M
17SEP07**



**READ
INSTRUCTIONS
THOROUGHLY
BEFORE
PROCEEDING**

INSTRUCTION SHEET - JUMPER PLACEMENT FOR 325 AND 625 AFTER MARKET INSTALLATIONS OR ELECTRONIC SENSING UNIT REPLACEMENT

IMPORTANT: 325 AND 625 ELECTRONIC SENSING UNITS USED IN AFTER MARKET INSTALLATIONS OR REPLACEMENT SITUATIONS ARE PROGRAMMABLE. DURING INSTALLATION OF A SYSTEM OR REPLACEMENT OF AN ELECTRONIC SENSING UNIT DO NOT ASSUME THAT THE SENSING UNIT JUMPERS ARE PRE-SET. THE MOUNTED ORIENTATION OF THE CONTROL BOX ASSEMBLY AND THE SUSPENSION TYPE MUST BE ESTABLISHED IN ORDER TO SET THE JUMPERS AS NEEDED TO PROGRAM THE SENSING UNIT TO THE COACH.

JP3 AND JP4 - CONTROL SUSPENSION TYPE (Page 2 of 2)

MOVE JUMPERS JP3 AND JP4 ACCORDING TO THE TYPE OF SUSPENSION ON THE VEHICLE.

JUMPERS JP3 AND JP4 DETERMINE SUSPENSION TYPE.

SPRING - LEAVE JUMPERS JP3 AND JP4 AS SHIPPED.
NEITHER JUMPER NEEDS TO BE MOVED.

AIR - LEAVE JUMPER JP4 AS SHIPPED, MOVE JP3 ONLY.
DIAGRAM BELOW SHOWS AIR SUSPENSION SETUP.

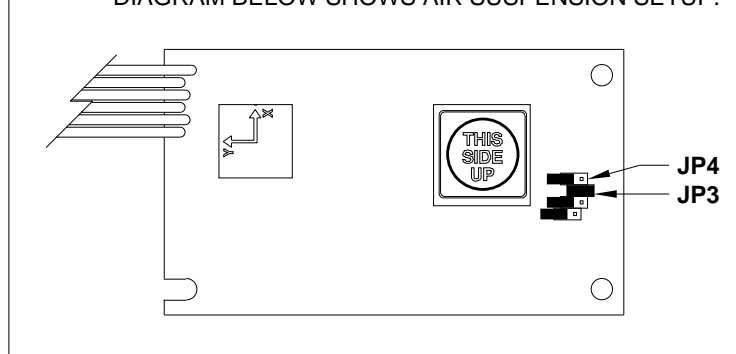

HYDRAULIC LINE CONNECTION DIAGRAM 625 OR 625S SERIES LEVELING SYSTEMS (WITH 4 STRAIGHT-ACTING JACKS)

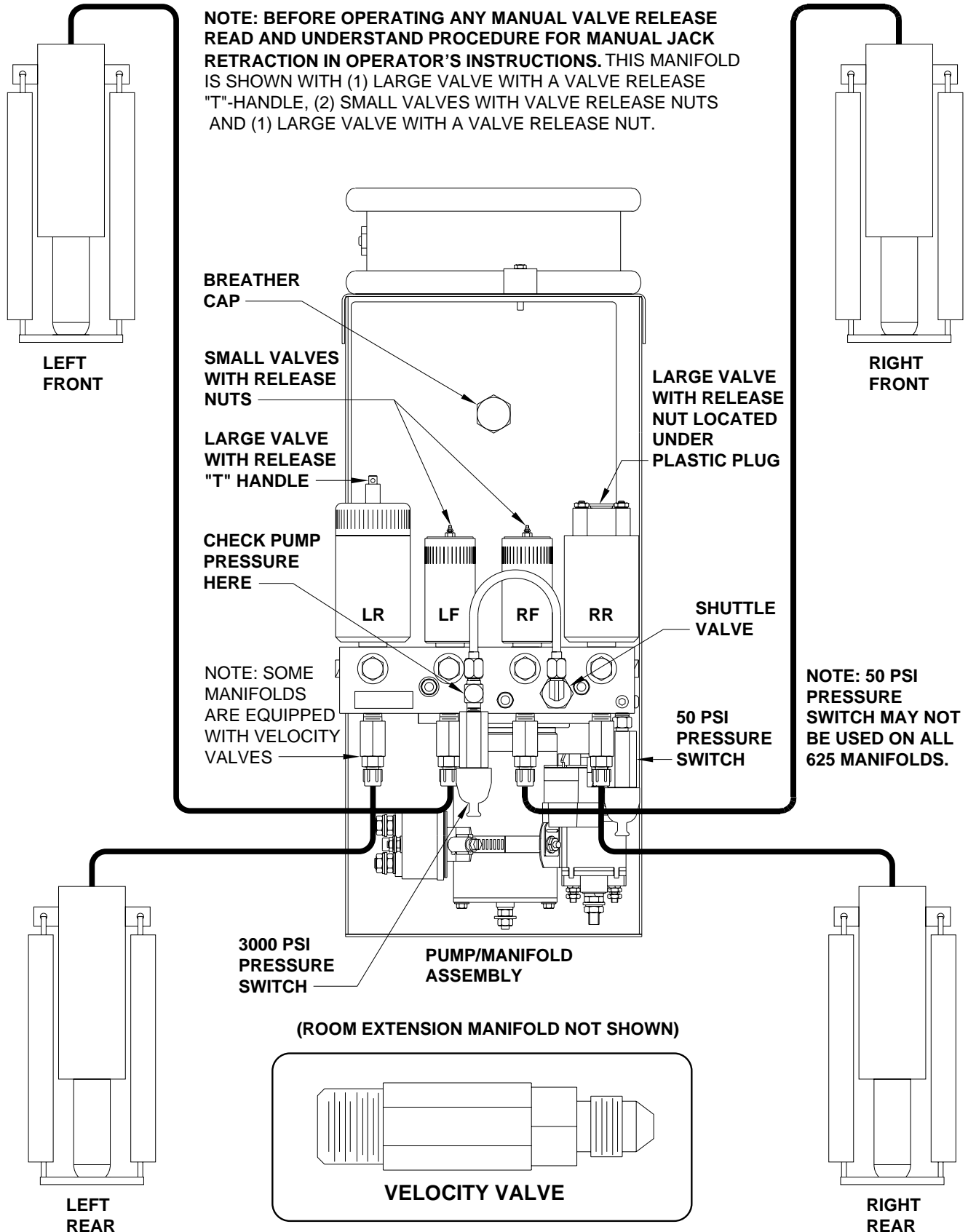

HYDRAULIC SCHEMATIC DIAGRAM

BI-AXIS LEVELING WITH STRAIGHT-ACTING JACKS

625 OR 625S SERIES

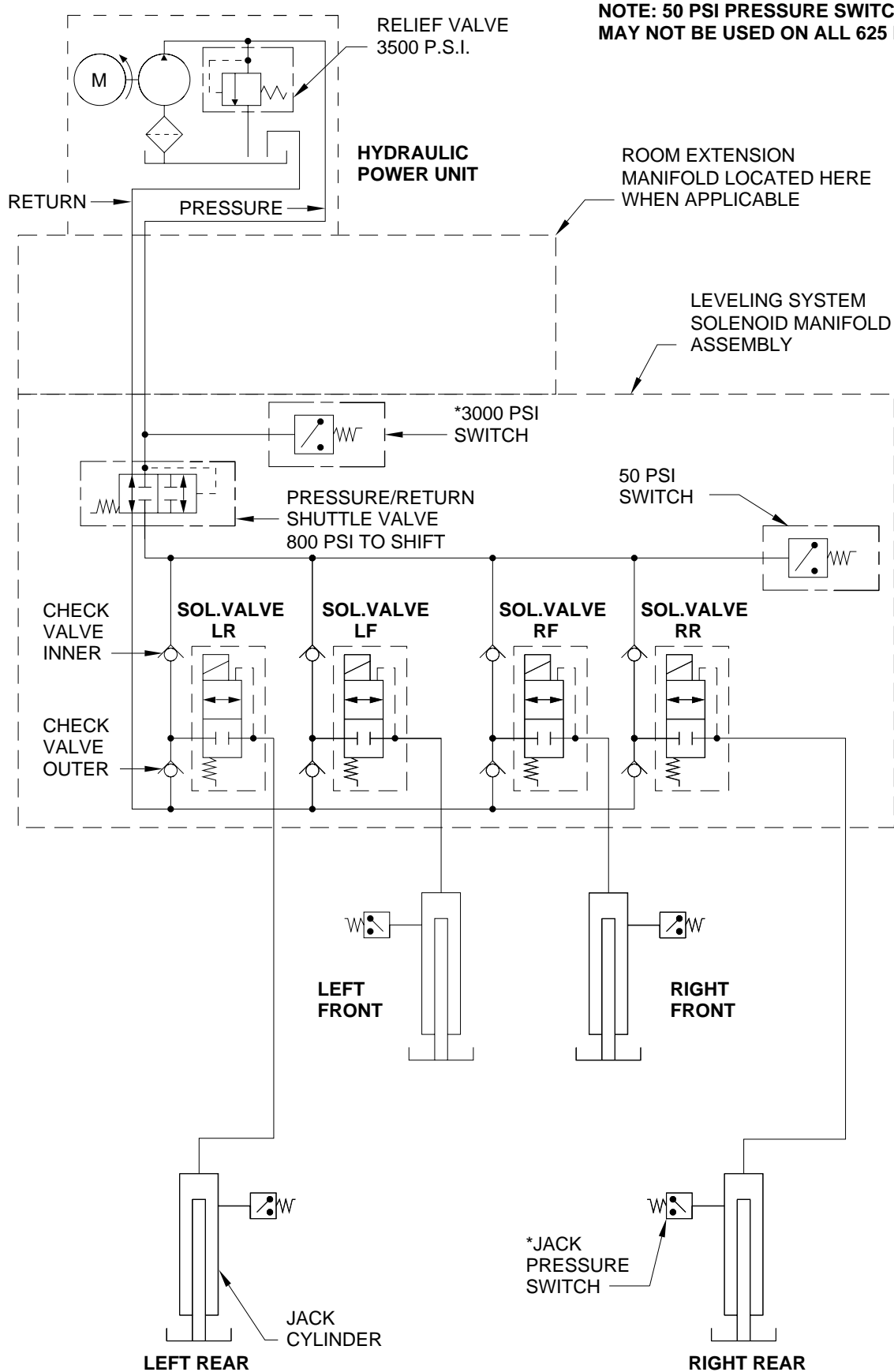

* USED ON AUTOMATIC SYSTEMS ONLY

MP65.601C
08SEP09

ELECTRICAL CONNECTION DIAGRAM

625 SERIES LEVELING SYSTEM

PARK BRAKE - MASTER WARNING LIGHT AND BUZZER

TOUCH PANEL - JACK WARNING LIGHTS AND PRESSURE SWITCHES

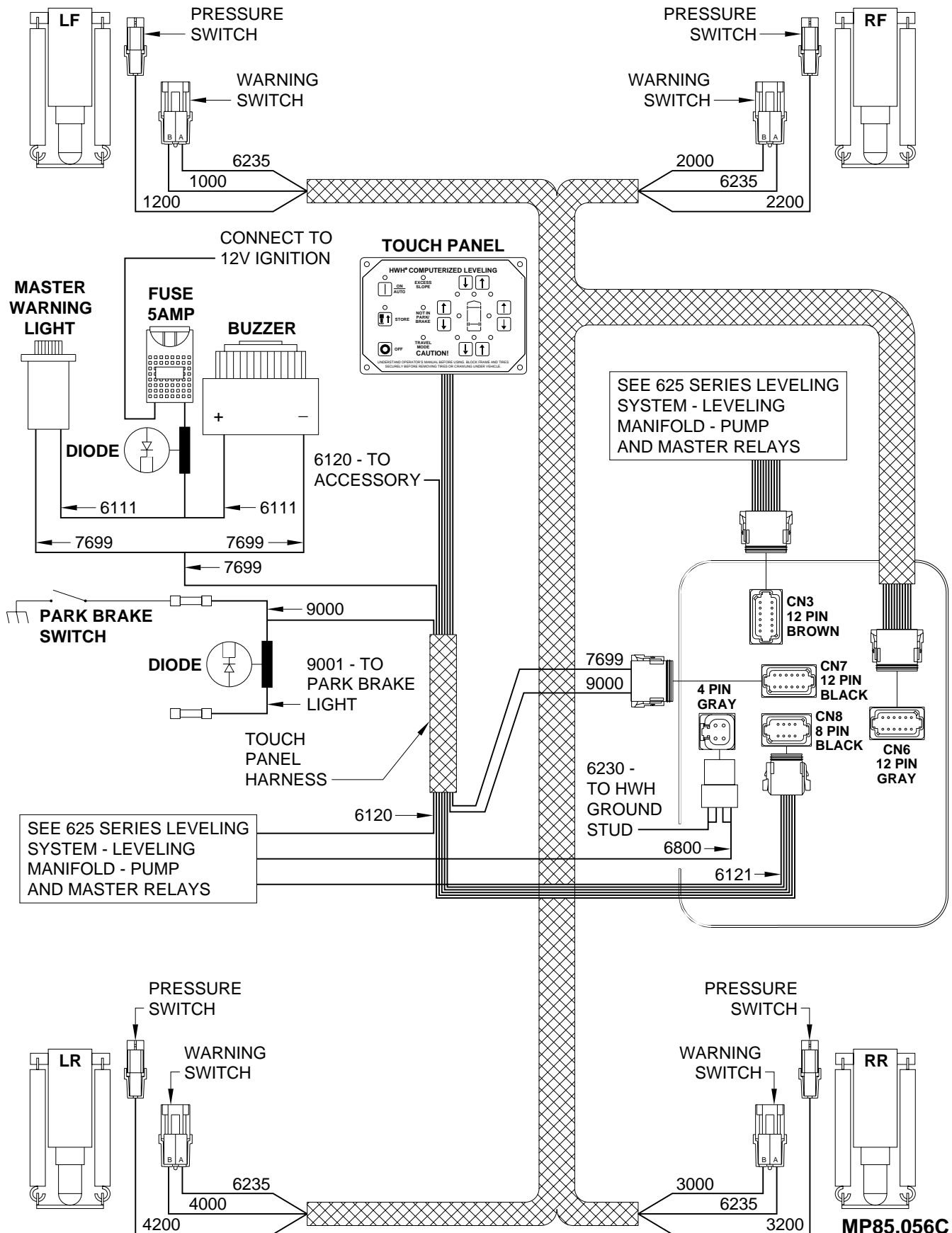

ELECTRICAL CONNECTION DIAGRAM

625 SERIES LEVELING SYSTEM

PILOT AIR DUMP - PARK BRAKE - MASTER WARNING LIGHT AND BUZZER TOUCH PANEL - JACK WARNING LIGHTS AND PRESSURE SWITCHES

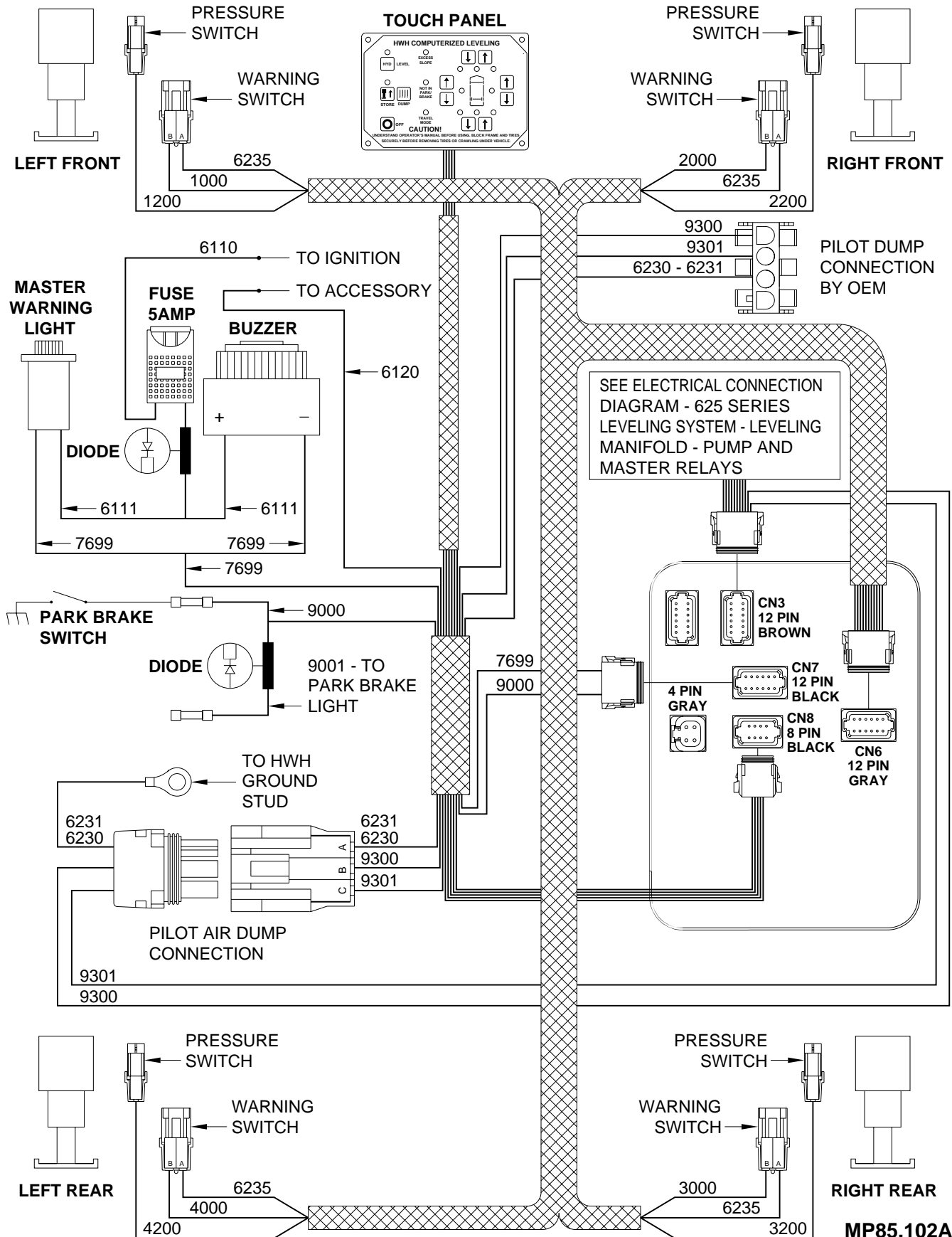

ELECTRICAL CONNECTION DIAGRAM

625 SERIES LEVELING SYSTEM

LEVELING MANIFOLD

PUMP AND MASTER RELAYS

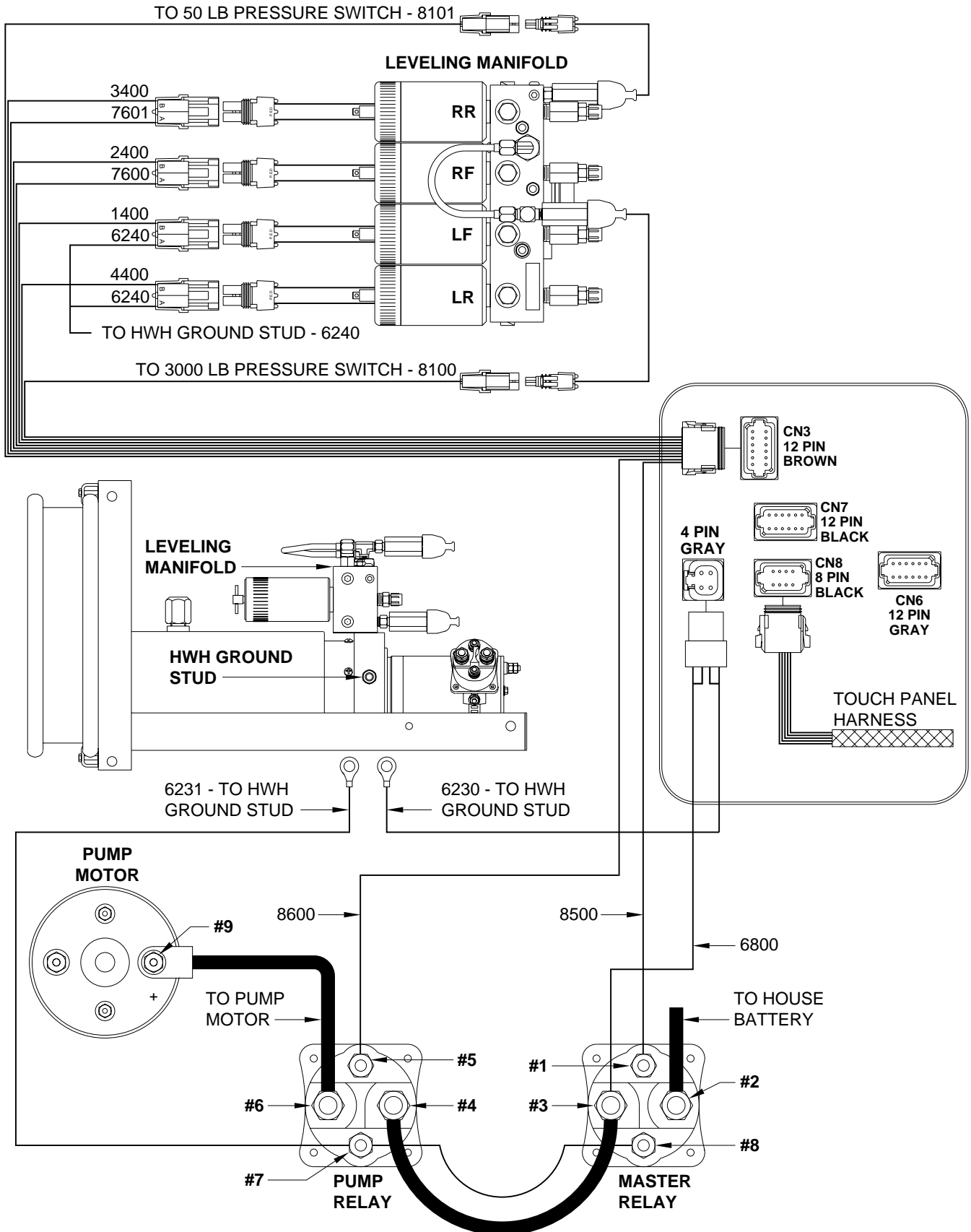

ELECTRICAL CONNECTION DIAGRAM 625 SERIES LEVELING SYSTEM LEVELING MANIFOLD PUMP AND MASTER RELAYS WITH PILOT AIR DUMP

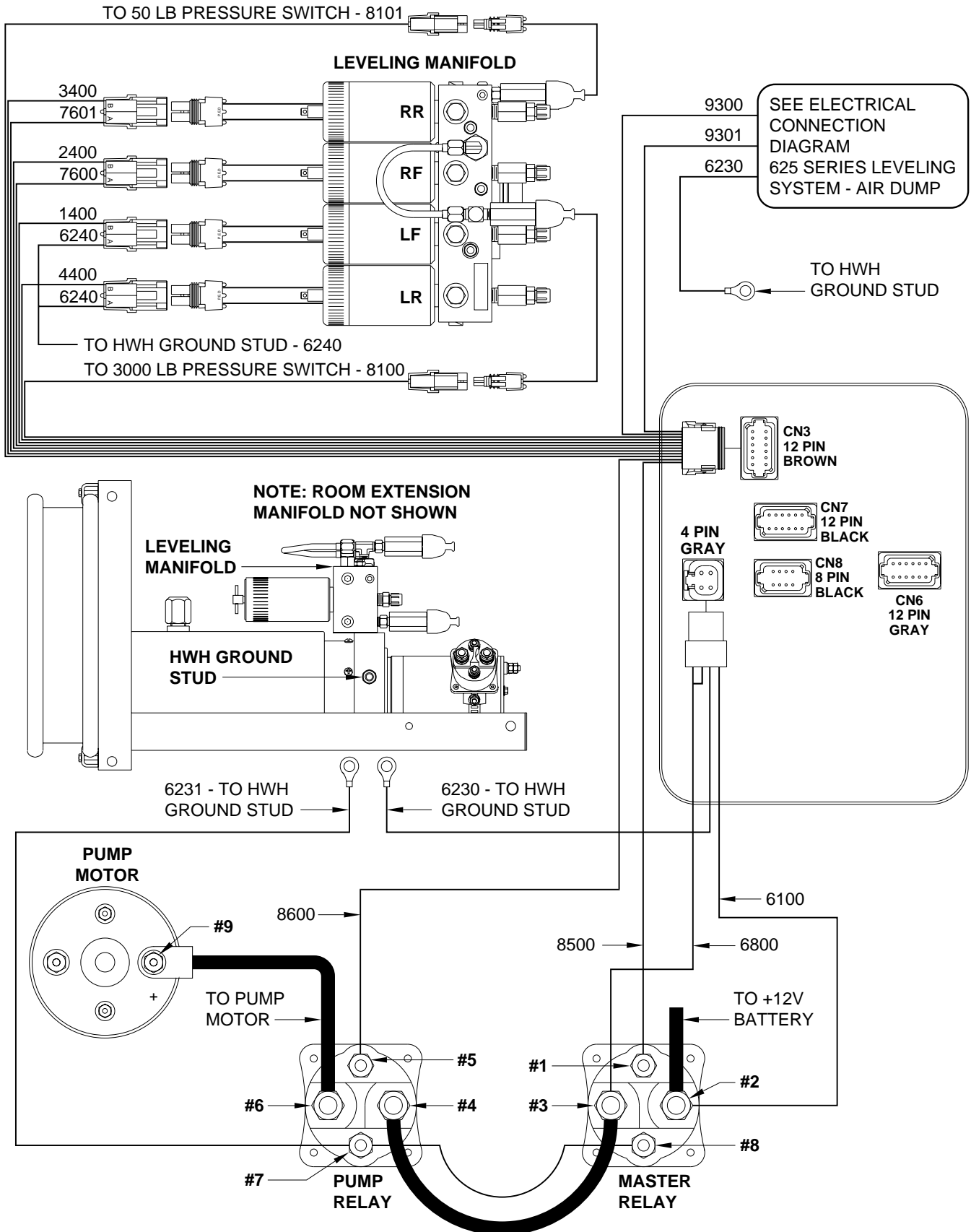

ELECTRICAL CONNECTION DIAGRAM 625 SERIES LEVELING SYSTEM LEVELING MANIFOLD - AIR DUMP PUMP AND MASTER RELAYS

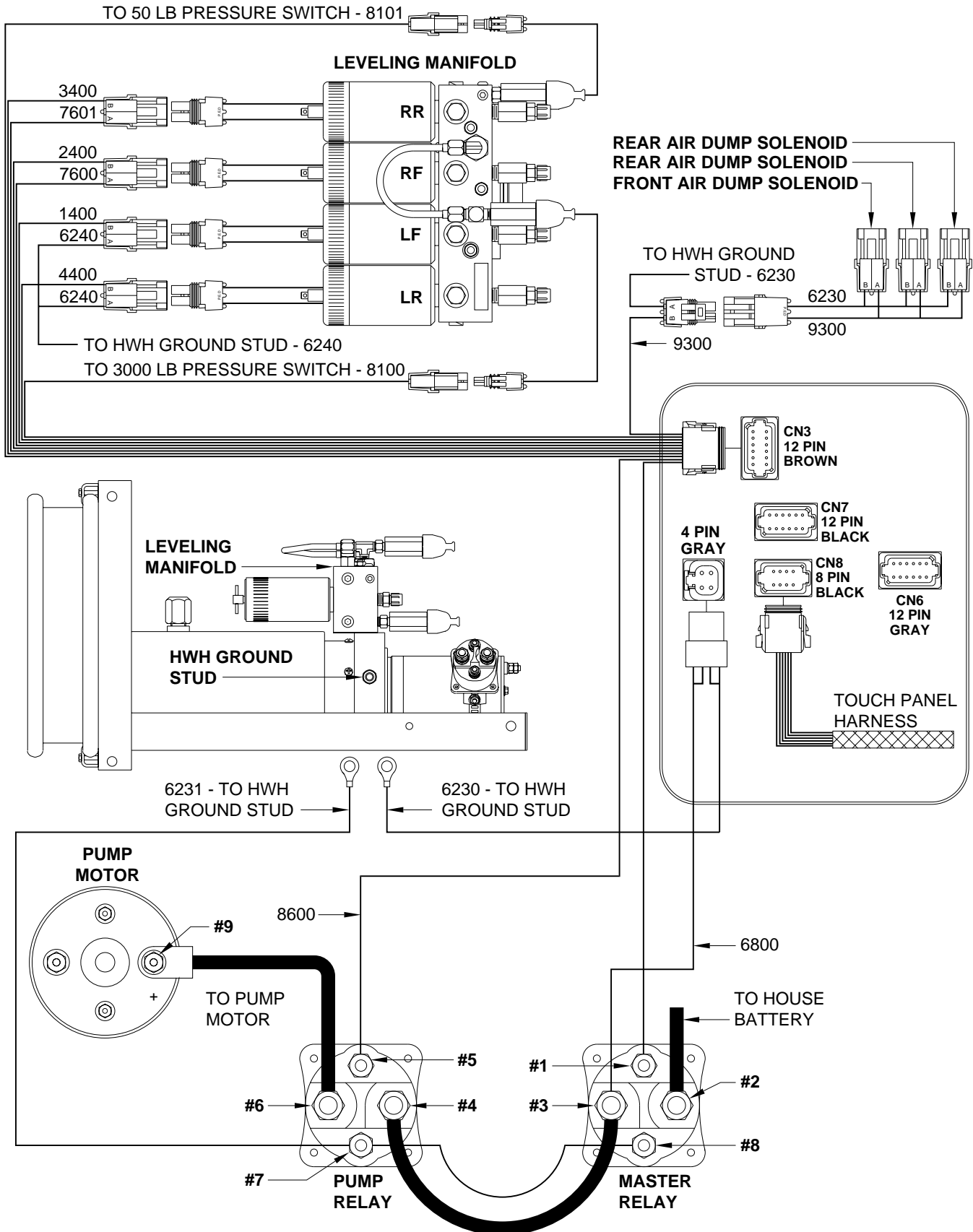

ELECTRICAL CONNECTION DIAGRAM

625 OR 625S SERIES LEVELING SYSTEMS

CONTROL BOX - LED - FUSE LOCATION AND DESCRIPTION

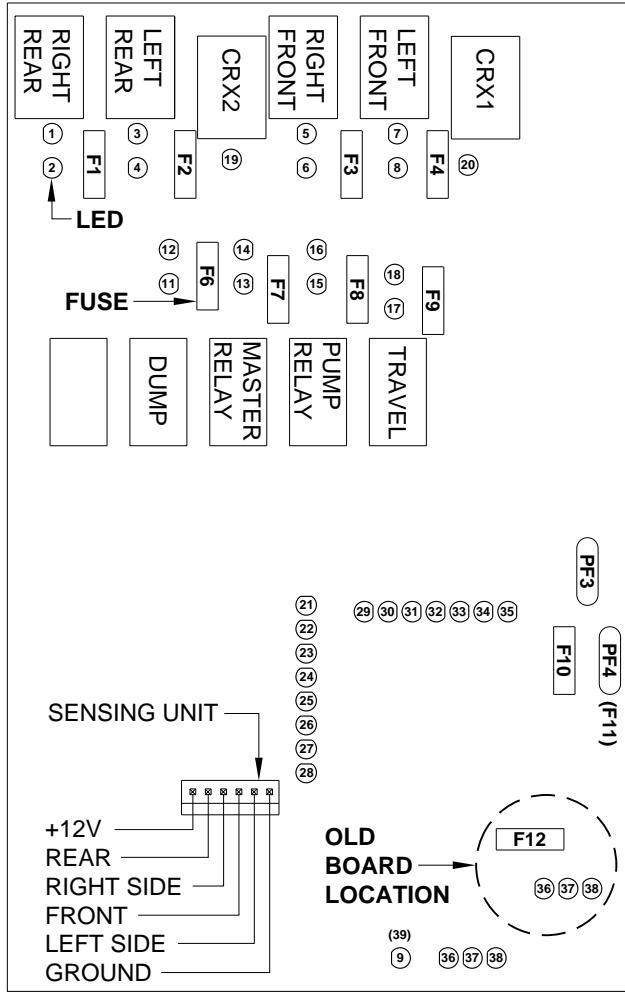

| LED | RELAY DESCRIPTION | FUSE |
|------------|----------------------------------|--------------|
| 1-YELLOW | RIGHT REAR COIL | |
| 2-RED | RIGHT REAR OUTPUT | F1 - 15 AMP |
| 3-YELLOW | LEFT REAR COIL | |
| 4-RED | LEFT REAR OUTPUT | F2 - 15 AMP |
| 5-YELLOW | RIGHT FRONT COIL | |
| 6-RED | RIGHT FRONT OUTPUT | F3 - 15 AMP |
| 7-YELLOW | LEFT FRONT COIL | |
| 8-RED | LEFT FRONT OUTPUT | F4 - 15 AMP |
| 11-YELLOW | DUMP COIL | |
| 12-RED | DUMP OUTPUT | F6 - 5 AMP |
| 13-YELLOW | MASTER RELAY COIL | |
| 14-RED | MASTER RELAY OUTPUT | F7 - 5 AMP |
| 15-YELLOW | PUMP COIL | |
| 16-RED | PUMP OUTPUT | F8 - 5 AMP |
| 17-YELLOW | TRAVEL COIL | |
| 18-RED | TRAVEL OUTPUT | F9 - 5 AMP |
| 19-YELLOW | CRX 2 | |
| 20-YELLOW | CRX 1 | |
| 21-YELLOW | LEFT FRONT WARN SW | |
| 22-YELLOW | RIGHT FRONT WARN SW | |
| 23-YELLOW | RIGHT REAR WARN SW | |
| 24-YELLOW | LEFT REAR WARN SW | |
| 25-RED | LEFT FRONT PRESS SW | |
| 26-RED | RIGHT FRONT PRESS SW | |
| 27-RED | RIGHT REAR PRESS SW | |
| 28-RED | LEFT REAR PRESS SW | |
| 29-RED | NOT USED | |
| 30-YELLOW | NOT USED | |
| 31-GREEN | 3000 LB PRESS SW INPUT | |
| 32-RED | MASTER WARN CONTROL | |
| 33-GREEN | 50 LB PRESS SW INPUT | |
| 34-RED | JACK INTERRUPT | |
| 35-RED | PARK BRAKE | |
| 36-RED | BOARD ENABLE | |
| 37-RED | ACCESSORY IN | F10 - 10 AMP |
| 38-RED | ACCESSORY OUT FOR MASTER WARNING | PF4 (F11) |
| (39) 9-RED | LINK LIGHT | |

NOTE: FOR DETAILED INPUT / OUTPUT INFORMATION ABOUT PIN CONNECTIONS SEE ELECTRICAL CONNECTION DIAGRAM - CONTROL BOX CONNECTION INFORMATION.

NOTE: A LIT YELLOW LED INDICATES THERE IS A GROUND SIGNAL TO TURN THE CORRESPONDING RELAY ON.

A LIT RED LED INDICATES THERE IS VOLTAGE ON IT'S CORRESPONDING OUTPUT PIN.

IF A YELLOW LED IS LIT AND THE CORRESPONDING RED LED IS OFF, EITHER IT'S FUSE IS BLOWN OR THE RELAY IS BAD.

IF THE YELLOW LED'S ARE WORKING BUT NO RED LED IS COMING ON THERE MAY BE PROBLEM WITH INPUT VOLTAGE IN THE 4-PIN CONNECTOR.

IF A YELLOW LED IS NOT LIT, THERE IS A PROBLEM WITH THE CONTROL BOX, TOUCH PANEL OR CONNECTION CABLE.

LED'S 19 AND 20 (YELLOW) WILL BE ON WHENEVER THE TOUCH PANEL IS ON UNLESS THE "STORE" BUTTON IS PUSHED. TWO SECONDS AFTER THE "STORE" BUTTON IS PUSHED, LED'S 7 AND 20 WILL TURN OFF. 5 SECONDS LATER LED'S 3 AND 19 WILL TURN OFF.

NOTE: THE TRAVEL RELAY IS WIRED AS A NORMALLY CLOSED RELAY. WHEN THE YELLOW LED (17) IS ON THE RELAY CONTACTS WILL OPEN. THE RED LED (18) WILL NOT BE ON. THE RED LED WILL BE ON IF THE LEVELING SYSTEM IS IN THE TRAVEL MODE AND THE IGNITION IS ON.

NOTE: THE TRAVEL RELAY IS NOT USED ON VEHICLES EQUIPPED WITH HWH AIR DUMP SYSTEMS. IT IS ONLY USED WITH PILOT OPERATED AIR DUMP SYSTEMS.

NOTE: ON NEWER CONTROL BOXES, FUSE F11 AND FUSE F12 HAVE BEEN REPLACED WITH POLY SWITCHES PF4 AND PF3. POLY SWITCHES PROTECT A COMPONENT OR WIRE AS A FUSE DOES EXCEPT THE POLY SWITCH WILL ALLOW CURRENT THROUGH WHEN THE OVERLOAD OR SHORT IS REMOVED. POLY SWITCHES ARE NOT REPLACEABLE.

ELECTRICAL CONNECTION DIAGRAM

625 SERIES LEVELING SYSTEM

TOUCH PANEL CONNECTIONS

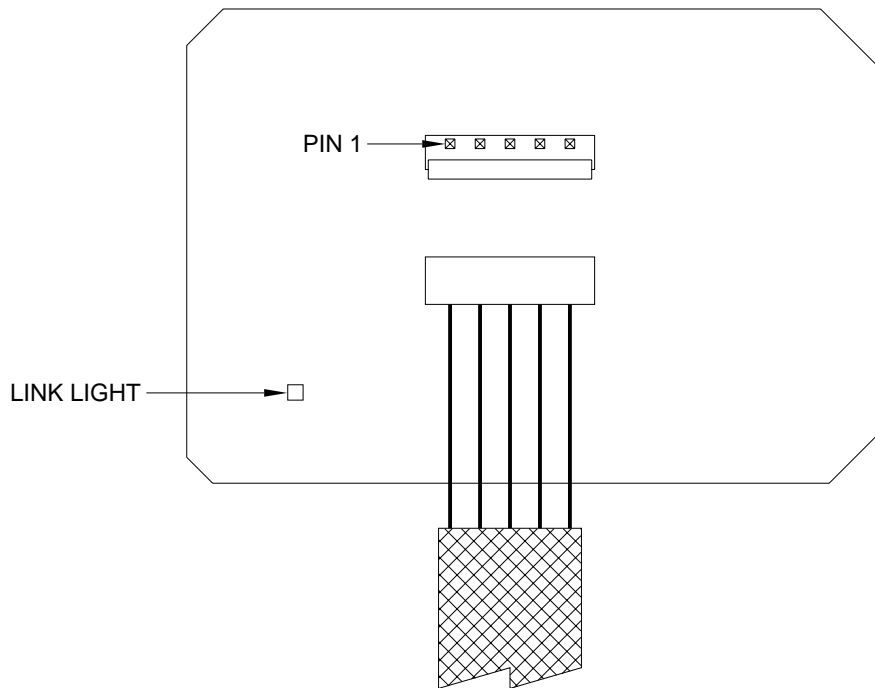
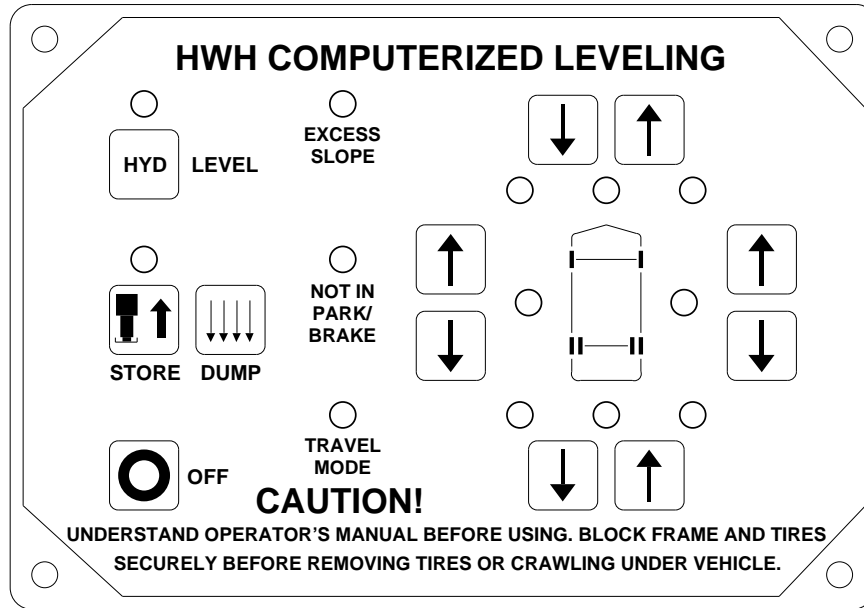

| PIN # | WIRE COLOR | WIRE NUMBER | WIRE DESCRIPTION AND FUNCTION |
|-------|------------|-------------|-----------------------------------|
| 1 | YELLOW | | CAN HIGH |
| 2 | GREEN | | CAN LOW |
| 3 | | | CAN SHEILD |
| 4 | WHITE | 6230 | GROUND FROM CONTROL BOX |
| 5 | RED | 6800 | SWITCHED BATTERY FROM CONTROL BOX |

ELECTRICAL CONNECTION DIAGRAM

CIRCUIT BOARD CONNECTOR AND PIN LOCATIONS

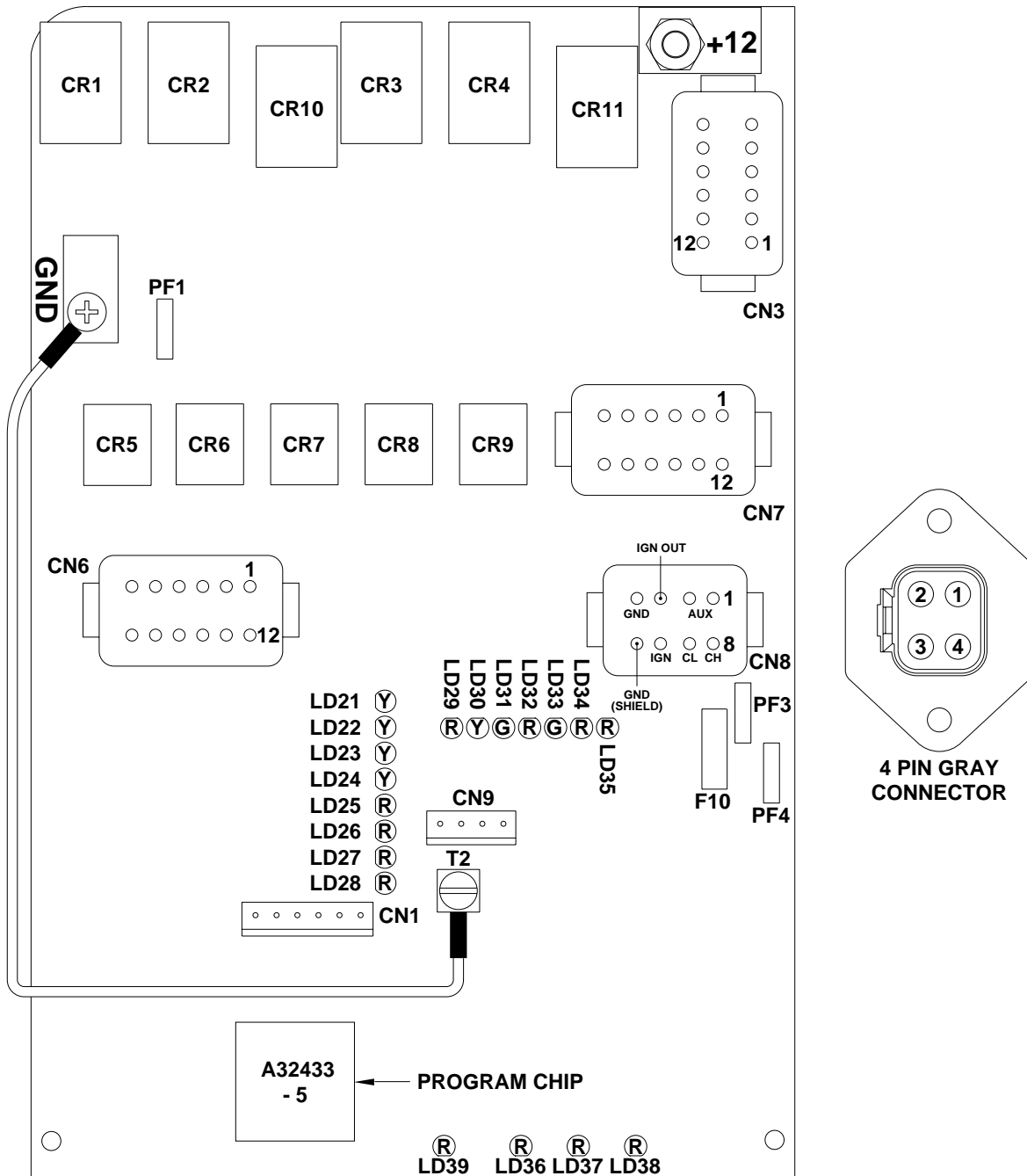

ELECTRICAL CONNECTION DIAGRAM

625 OR 625S SERIES LEVELING SYSTEMS

CONTROL BOX CONNECTION INFORMATION

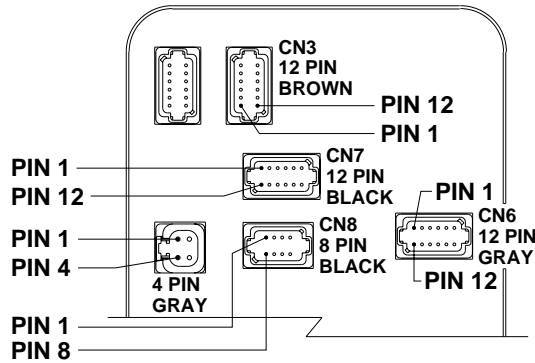

| PIN # | WIRE COLOR | WIRE NUMBER | WIRE DESCRIPTION AND FUNCTION |
|-------------------------------------|------------|-------------|---|
| 4 PIN GRAY CONNECTOR | | | |
| 1 | BLACK | 6800 | SWITCHED +12V BATTERY POWER FROM MASTER RELAY |
| 2 | BLACK | 6800 | SWITCHED +12V BATTERY POWER FROM MASTER RELAY |
| 3 | WHITE | 6230 | GROUND FROM HWH GROUND STUD |
| 4 | RED | 6100 | +12 BATTERY FROM MASTER RELAY |
| 12 PIN BROWN CONNECTOR - CN3 | | | |
| 1 | BLACK | 8500 | MASTER RELAY CONTROL - SWITCHED +12 |
| 2 | BLACK | 8100 | 3000 LB PRESSURE SWITCH - SWITCHED GROUND |
| 3 | BLACK | 8101 | 50 LB PRESSURE SWITCH - SWITCHED GROUND |
| 4 | BLACK | 9301 | SWITCHED +12 FOR TRAVEL |
| 5 | BLACK | 1400 | SWITCHED +12 FOR LEFT FRONT SOLENOID VALVE |
| 6 | BLACK | 7600 | GROUND FOR RIGHT FRONT SOLENOID VALVE |
| 7 | BLACK | 7601 | GROUND FOR RIGHT REAR SOLENOID VALVE |
| 8 | BLACK | 4400 | SWITCHED +12 FOR LEFT REAR SOLENOID VALVE |
| 9 | BLACK | 3400 | SWITCHED +12 FOR RIGHT REAR SOLENOID VALVE |
| 10 | BLACK | 2400 | SWITCHED +12 FOR RIGHT FRONT SOLENOID VALVE |
| 11 | BLACK | 9300 | SWITCHED +12 FOR DUMP |
| 12 | BLACK | 8600 | PUMP RELAY CONTROL - SWITCHED +12 |
| 12 PIN BLACK CONNECTOR - CN7 | | | |
| 1 THRU 6 | | | NO CONNECTION |
| 7 | BLACK | 9000 | SWITCHED GROUND FROM PARK BRAKE SWITCH |
| 8 THRU 10 | | | NO CONNECTION |
| 11 | BLACK | 7699 | BUZZER & MASTER WARNING LIGHT CONTROL - SWITCHED GROUND |
| 12 | | | NO CONNECTION |
| 8 PIN BLACK CONNECTOR - CN8 | | | |
| 1 AND 2 | | | NO CONNECTION |
| 3 | RED | 6800 | SWITCHED BATTERY |
| 4 | WHITE | 6230 | GROUND |
| 5 | | | CAN SHIELD |
| 6 | RED | 6120 | +12 ACCESSORY / IGNITION |
| 7 | GREEN | | CAN LOW |
| 8 | YELLOW | | CAN HIGH |
| 12 PIN GRAY CONNECTOR - CN6 | | | |
| 1 AND 2 | | | NO CONNECTION |
| 3 | BLACK | 1000 | SWITCHED GROUND FROM LEFT FRONT WARNING SWITCH |
| 4 | BLACK | 2000 | SWITCHED GROUND FROM RIGHT FRONT WARNING SWITCH |
| 5 | BLACK | 1200 | SWITCHED GROUND FROM LEFT FRONT PRESSURE SWITCH |
| 6 | BLACK | 2200 | SWITCHED GROUND FROM RIGHT FRONT PRESSURE SWITCH |
| 7 | BLACK | 3200 | SWITCHED GROUND FROM RIGHT REAR PRESSURE SWITCH |
| 8 | BLACK | 4200 | SWITCHED GROUND FROM LEFT REAR PRESSURE SWITCH |
| 9 | BLACK | 3000 | SWITCHED GROUND FROM RIGHT REAR WARNING SWITCH |
| 10 | BLACK | 4000 | SWITCHED GROUND FROM LEFT REAR WARNING SWITCH |
| 11 | | | NO CONNECTION |
| 12 | WHITE | 6235 | SHARED GROUND FOR WARNING SWITCHES |

MASTER LIGHT/BUZZER CONNECTION DIAGRAM

MANUAL LEVELING SYSTEMS

625 SERIES LEVELING SYSTEM

A MASTER WARNING INDICATOR SHOULD ALWAYS BE USED. WHEN THE LEVELING SYSTEM HAS STRAIGHT-ACTING JACKS A WARNING BUZZER MUST BE USED.

NOTE: BY SUPPLYING IGNITION POWER TO THE WARNING BUZZER AND LIGHT, AND "ACC" POWER TO THE CONTROL BOX, THE SYSTEM MAY BE OPERATED IN ACCESSORY WITHOUT THE BUZZER SOUNDING. THE NEGATIVE SIGNAL FOR THE WARNING INDICATORS MUST ALWAYS COME FROM THE CONTROL BOX.

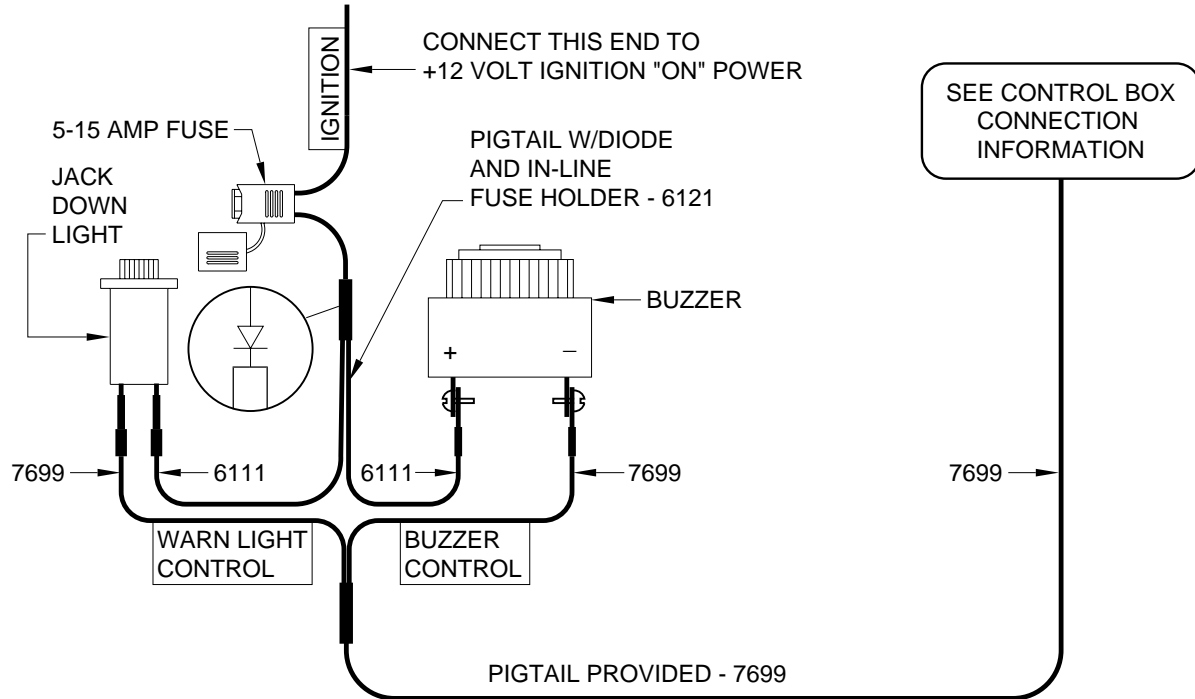

625 TROUBLE SHOOTING GUIDE

GLOSSARY

AIR DUMP - PILOT: The pilot operated air dump system is supplied by the chassis manufacturer. This system uses an electronically controlled two position pilot valve that switches the suspension from a travel mode to a dump mode. In the travel mode, the height control valves control the suspension. In the dump mode, the height control valves are isolated from the air bags and the air is exhausted from the air bags. Only the air in the bags is exhausted, the air in the rest of the system remains. The pilot valve has a simple 12 volt coil on each end of the valve. Part of the control harness is supplied by the vehicle manufacturer and the harness from the HWH control box is supplied by HWH. There are normally three wires in the HWH harness, a white ground wire, a number 9300 black wire for the dump side and a number 9301 black wire for the travel side of the pilot valve. The HWH control box switches +12 volts to control the pilot valve. When power is supplied to either coil on the pilot valve, the valve remains in that position until power is supplied to the other coil.

NOTE: Other types of pilot operated air dump systems may be used such as manually controlled valves, but the above described system is controlled by the HWH leveling system controls.

AIR DUMP VALVE - HWH: The air dump valve is a normally closed valve that is actuated with a 12 volt coil. When power is supplied to the valve, the valve opens to allow air through. When power is removed, the valve is closed with a spring. Although there are different arrangements, the most common is one HWH dump valve for each suspension height control valve. The dump valve is teed into the air line between the height control valve and the suspension air bags. When the dump valves are open, they exhaust all the air from the air bags and the vehicle suspension. Normally the complete harness for this system is supplied by HWH. There are two wires to each valve, a white wire and a black number 9300 wire. The HWH control box switches +12 volts to open the air dump valves.

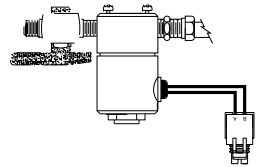

CHECK VALVE - LEVELING SYSTEM HYDRAULIC MANIFOLD: There are two check valves for each solenoid valve. The check valves allow two solenoid valves to be opened at the same time without fluid flowing from one jack to the other. This keeps the vehicle from dropping when one jack is on the ground and another jack is being extended. Although the check valves can be replaced, HWH should be contacted when there are check valve problems.

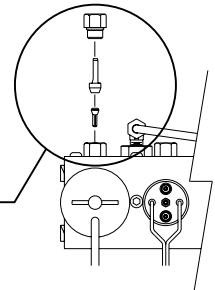

CONTROL BOX: The control box utilizes inputs from the touch panel, level sensing unit, manifold and jack pressure switches and jack warning switches to control the leveling system. The control box supplies outputs to the touch panel to control indicator lights and to the pump/manifold assembly to control the hydraulic solenoid valves and the hydraulic pump. The control box also supplies outputs to control the air dump system if needed. The level sensing unit and the mini blade fuses are the only serviceable parts in the control box. The control box is mounted to the power unit/manifold assembly. Because the sensing unit is mounted in the control box, the orientation of the control box is critical. The sensing unit may need to be programmed if the control box is replaced. (SEE LEVEL SENSING UNIT) The ignition must be in the ON or ACC. position and the park brake must be set for the control box to function. The control box is equipped with LEDs to indicate different functions are operating. A lit LED indicates a function is working, LEDs are not turned on to indicate a problem.

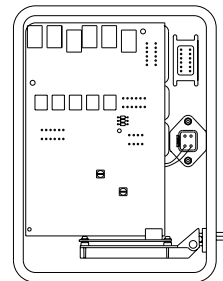

JACK CYLINDER: The jack cylinders are hydraulic, single acting cylinders which are used to level and stabilize the vehicle. The cylinders are extended with fluid supplied by the hydraulic pump under pressure. The jacks are retracted by the use of a pair of springs which pull the jack up when it's solenoid valve is open and the pump is not running. Jack cylinders are mounted to the frame of the vehicle in a pivot bracket. When a cylinder has a problem such as a leak, only the cylinder should be replaced. The cylinders are available in different capacities, lengths and spring arrangements. The capacities are 6,000#, 9,000#, 12,000#, 16,000# and 24,000#.



625 TROUBLE SHOOTING GUIDE

GLOSSARY

LEVEL SENSING UNIT: The level sensing unit controls the yellow LEVEL indicators on the touch panel. The sensing unit is mounted in the control box. The sensing unit must be programmed for the mounting direction of the control box and the type of suspension, air or spring. The sensing unit is equipped with four sets of pins with jumpers. These are used to program the sensing unit. There is a detailed instruction sheet available for programming the sensing unit. The sensing unit has six wires. There is a red +12 volt supply wire on one end of the MTA plug and a white ground wire on the other end of the plug. The red power wire is hot when the ignition is in the ON or ACC. position. The center four wires supply a ground signal to turn a yellow LEVEL light on when that side or end of the vehicle is low. The yellow wire is for the left side light, the black wire is for the front light, the green wire is for the right side light and the red wire is for the rear light. The sensing unit can be replaced if needed.

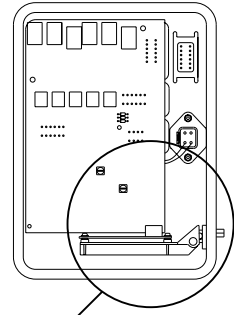

NOTE: The level sensing unit has a tolerance for leveling. The vehicle may not always be 100% level and may level somewhat differently when the vehicle is parked in different places. The vehicle should be within 3 to 4 inches front to rear and 1 inch side to side when all yellow level lights are out.

MANIFOLD HYDRAULIC: The hydraulic manifold is mounted on top of the pump. The manifold distributes the hydraulic fluid to the jacks as needed to extend the jacks. When retracting jacks the fluid returns to the pump through the manifold. The manifold consists of four solenoid valves, a pair of check valves for each solenoid valve, a 50 p.s.i. pressure switch, a 3000 p.s.i. pressure switch and a shuttle valve. The replaceable parts of the manifold are the solenoid valves, the pressure switches and the shuttle valve. If it is determined a check valve is bad, it may be required to replace the complete manifold. Contact HWH when check valve problems occur.

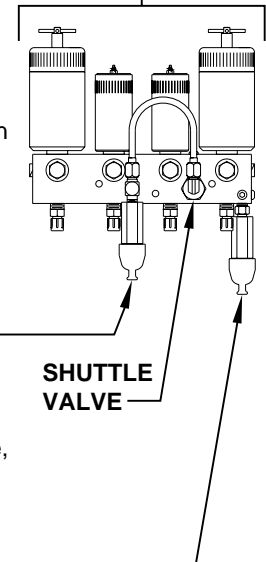

PRESSURE SWITCH - 3000 P.S.I. MANIFOLD: This pressure switch is a single wire, normally open switch. It is mounted on the leveling system hydraulic manifold. The contacts of this switch will close when the pressure in the manifold reaches 3000 p.s.i. When the contacts of the switch close, this supplies a ground signal to the control box. During the leveling mode, if a yellow level light is on and this switch closes, the control box will turn the "EXCESS SLOPE" light that is on the touch panel on. The panel will turn off with the "EXCESS SLOPE" light remaining on. The "EXCESS SLOPE" light will be on whenever the ignition is on until the jacks are completely retracted with the "STORE" button or the park brake is released with the ignition on.

PRESSURE SWITCH - 50 P.S.I. MANIFOLD: This pressure switch is a single wire, normally open switch. It is mounted on the leveling system hydraulic manifold. The contacts of this switch will close when the pressure in the manifold reaches 50 p.s.i. When the contacts of the switch close, this supplies a ground signal to the control box. The solenoid valves that control the jacks will not open until the control box sees the ground signal from the 50 p.s.i. switch. Without this ground signal, the pump will run under load and no jacks will extend. This switch will not interfere when retracting jacks.

PRESSURE SWITCH - JACK: This pressure switch is a single wire, normally open switch. There is one mounted on each jack. The contacts of this switch close when the pressure the switch is set at is reached. The contacts of this switch, when closed, supply a ground signal to the control box. Smaller jacks and replacement switches are set at 140 p.s.i. Larger jacks will be set at a higher pressure. The switches can be adjusted as necessary. The jack pressure switches are used to stabilize the vehicle during the automatic leveling procedure. The jack pressure switches should be adjusted so each jack lifts the vehicle at least 3/4 to 1 inch after reaching the ground when used to stabilize the vehicle.

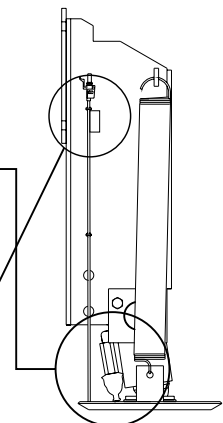

NOTE: All hydraulic pressure switches supplied by HWH at this time are manufactured by HWH. These switches all look the same. The switches can be identified by a tag near the Packard connector on the switch wire. The switch part number and the set pressure are listed on the tag.

625 TROUBLE SHOOTING GUIDE

GLOSSARY

PUMP: The hydraulic pump supplies fluid to extend the jacks and operate any HWH slide mechanisms. The pump is turned with a +12 volt motor. (Some systems may use a +24 volt motor) The motor is a replaceable part. The pump motor is internally grounded. This requires the pump/manifold assembly to have a good frame ground through the mounting of the assembly. This may require a separate ground cable, minimum size #2, to supply the necessary ground for the assembly. The oil level in the pump reservoir should be checked with all HWH cylinders, leveling jacks and/or slides retracted. The oil level should be (1) inch down from the top of the reservoir fill hole. The pump should not run when the leveling jacks are being retracted. The pump motor does not have thermal protection built into the motor. The correct pump pressure should be 3500 p.s.i. When checking the pump pressure, the minimum pressure should be 3300 p.s.i. and the maximum pressure should be 3600 p.s.i. The pump reservoir is equipped with a breather cap/dipstick that has a 1/4 inch nut driver in the end of the dipstick to manually open solenoid valves with valve release nuts. The reservoir has to be vented and should never be plugged tight.

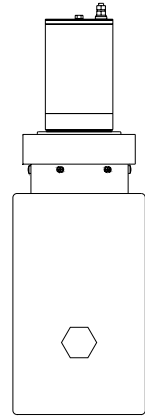

RELAY - MASTER: The master relay is a continuous duty, normally open, four post relay that consists of one pair of contacts and a coil. The contacts are used to switch +12 volts to the pump relay and to the control box. Power in and power out on the contacts can be reversed. The coil is a +12 coil. There is a small post on the relay for each side of the coil. Either post can be +12 volts with the other post being ground. The control box switches +12 volts to turn the relay on. With the relay turned on, the contacts will close supplying +12 volts to the pump relay and the control box. With the relay off, there should be power on one of the large posts only. With the relay on, the voltage on both large posts should be the same. With the relay off, both sides of the relay coil, the small posts, should show a ground. With the relay on, one small post should show +12 volts, the other small post should show ground. If the ground is missing, both small posts will show +12 volts. The master relay will be on whenever the POWER ON light on the touch panel is on or while a room control switch is being pushed to EXTEND or RETRACT.

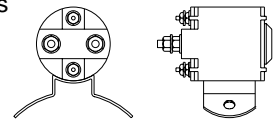

RELAY - PUMP: The pump relay is an intermittent duty, normally open, four post relay that consists of one pair of contacts and a coil. The contacts are used to switch +12 volts to the pump motor. Power in and power out on the contacts can be reversed. The coil is a +12 coil. There is a small post on the relay for each side of the coil. Either post can be +12 volts with the other post being ground. The control box switches +12 volts to turn the relay on. With the relay turned on, the contacts will close supplying +12 volts to the pump motor. With the relay off, there should be power on one of the large posts only. With the relay on, the voltage on both large posts should be the same. With the relay off, both sides of the relay coil, the small posts, should show a ground. With the relay on, one small post should show +12 volts, the other small post should show ground. If the ground is missing, both small posts will show +12 volts.

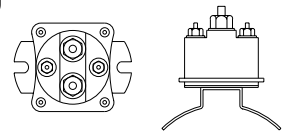

SHUTTLE VALVE: The shuttle valve is located on the leveling system hydraulic manifold. (See MANIFOLD HYDRAULIC) Fluid flows from the pump to the manifold, through a fitting on top of the manifold, through a U shaped tube to a fitting on top of the shuttle valve, then into the manifold to extend the jacks. The fluid flows from the manifold through the shuttle valve back to the pump when retracting the jacks. The shuttle valve is a hydraulically actuated valve. When the pump is running, the shuttle valve shifts to allow the fluid into the manifold. At the same time, the shuttle valve closes the path for fluid return to the pump. It takes approximately 800 p.s.i. to shift the shuttle valve. When the pump shuts off, the shuttle valve should shift back to the off position. This will allow fluid to flow from the manifold to the pump when the jacks are retracted. The shuttle valve is a replaceable part.

