

**Chassis**

**050 Driveline**

190 WHEELBASE

CAT 3126 WITH AT545, 2000 TRANS 1550 SERIES

*With: FEATURE 40187-01 & 40187-08 WITH 40421-01 & 40434-01  
From CSN 30043490*

1

CUMMINS ISB WITH AT545, 2000 TRANS 1550 SERIES

*With: FEATURE 40177-02 OR 40177-08 WITH 40421-01 OR 40434-01  
From CSN 30043490*

2

190, 211, 232 WHEELBASE

CAT C7 WITH 2500PTS TRANSMISSION

*With: FEATURE 40187 WITH FEATURE 40432-09*

3

CAT C7 WITH 3000PTS TRANSMISSION

*With: FEATURE 40187 WITH FEATURE 40432-10*

4

211 WHEELBASE

CAT 3126 WITH AT545, 2000 TRANS 1550 SERIES

*With: FEATURE 40187-01 & 40187-08 WITH 40421-01 & 40434-01  
From CSN 30043490*

5

CAT 3126 WITH MT643 TRANS 1610 SERIES

*From CSN 30087475*

6

CUMMINS ISB WITH AT545, 2000 TRANS 1550 SERIES

*With: FEATURE 40177-02 OR 40177-08 WITH 40421-01 OR 40434-01  
From CSN 30043490*

7

CUMMINS ISB/ISC WITH MT643 TRANS 1610 SERIES

*From CSN 30087475*

8

MD3060/B300 TRANS 1610 SERIES

*From CSN 30087475*

9

232 WHEELBASE

CAT 3126 WITH AT545, 2000 TRANS 1550 SERIES

*With: FEATURE 40187-01 & 40187-08 WITH 40421-01 & 40434-01  
From CSN 30043490*

10

CAT 3126 WITH MT643 TRANS 1610 SERIES

*From CSN 30087475*

11

CUMMINS ISB WITH AT545, 2000 TRANS 1550 SERIES

*With: FEATURE 40177-02 OR 40177-08 WITH 40421-01 OR 40434-01  
From CSN 30043490*

12

CUMMINS ISB/ISC WITH MT643 TRANS 1610 SERIES

*From CSN 30087475*

---

13

MD3060/B300 TRANS 1610 SERIES

*From CSN 30087475*

---

14

MD3060/B400 TRANS 1710 SERIES

*From CSN 30087475*

---

15

**Models:** A3FE, C3FE  
**190 WHEELBASE**  
**CAT 3126 WITH AT545, 2000 TRANS 1550 SERIES**  
**With:** FEATURE 40187-01 & 40187-08 WITH 40421-01 & 40434-01  
**BSN:** From CSN 30043490

Key	PartNumber	Qty	Description	Comment
-----	------------	-----	-------------	---------

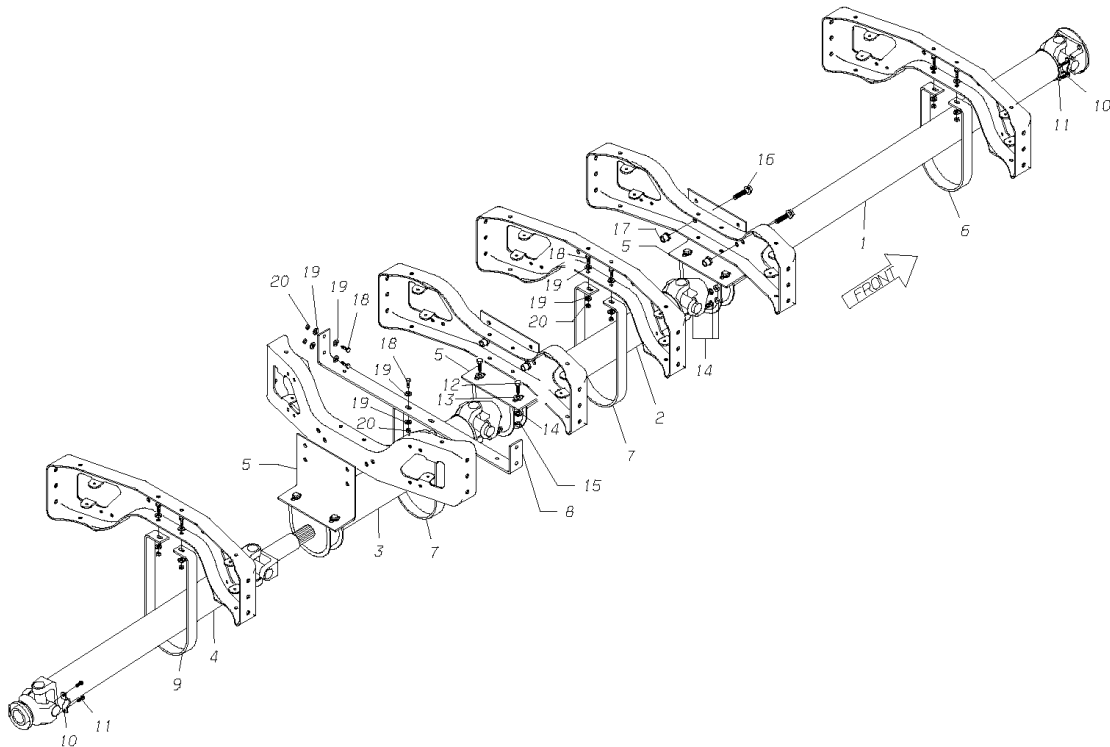

**Models:** A3FE, C3FE  
**190 WHEELBASE**  
**CAT 3126 WITH AT545, 2000 TRANS 1550 SERIES**  
**With:** FEATURE 40187-01 & 40187-08 WITH 40421-01 & 40434-01  
**BSN:** From CSN 30043490

Key	PartNumber	Qty	Description	Comment
1	0015184	1	SHAFT ASSY,1550,COUPLING,65.27 LONG,PUR	
2	0015187	1	SHAFT ASSY,1550,MALE SLIP,44.89 LONG,PUR	
3	0015194	1	SHAFT ASSY,1550,FEMALE SLIP,67.16 LONG,	WITH 19-21K AXLES
3	0039974	1	SHAFT ASSY,1550,FEMALE SLIP,65.25 LONG,	WITH 23K AXLES
5	0017251	2	BRACKET,MTG,DRIVELINE CENTER BEARING,	
6	0017245	1	STRAP,GUARD,DRIVELINE,10.75 LONG	
7	1987932	2	STRAP,GUARD,DRIVELINE,13.50 LONG	
8	0000096	2	BRACKET,SUPPORT,DRIVE SHAFT GUARD,HDFE	
NI	0664995		KIT,BEARING & JOURNAL 1700	ALL LOCATIONS
10	1326610	6	STRAP,YOKE,SPICER 3-70-99	
11	1567486	12	BOLT,3/8-24 X 3/4,SPICER 6-73-412	
12	1942135	4	CAPSCREW,HEX HD 1/2-13X 1 1/4,GR8,	
13	1003045	4	WASHER,FLAT,17/32 X 1 1/16 X 7/64,HDN,	
14	2001212	4	LOCKWASHER,SPLIT RING, 1/2 ,LHT,YEL ZN	
15	1003094	4	NUT,HEX HD,1/2-13,GR 8,YEL ZN DICH	
16	1636943	4	PIN,FLG HEAD,HUCKSPIN,.50X2.22,HSP8	
17	1636968	4	COLLAR,HUCKSPIN,.50,HSCH-R16	
18	0803213	14	CAPSCREW,HEX HD,3/8-16X1 1/4,GR8,YEL	
19	1107085	28	WASHER,FLAT,13/32 X 13/16 X 3/32,HDN,BLK	
20	0826297	14	NUT,HEX HD,3/8-16 LOCK,YEL ZN DICH	

**Models:** A3FE, C3FE  
**190 WHEELBASE**  
**CUMMINS ISB WITH AT545, 2000 TRANS 1550 SERIES**  
**With:** FEATURE 40177-02 OR 40177-08 WITH 40421-01 OR 40434-01  
**BSN:** From CSN 30043490

Key	PartNumber	Qty	Description	Comment
-----	------------	-----	-------------	---------

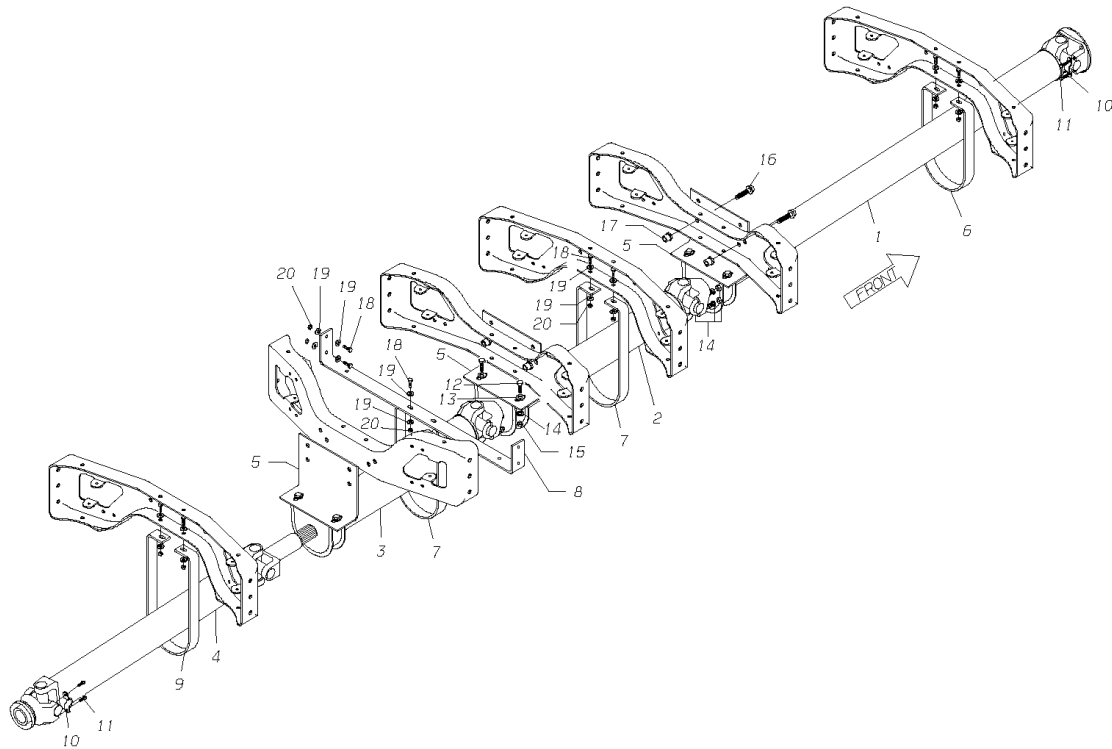

**Models:** A3FE, C3FE  
**190 WHEELBASE**  
**CUMMINS ISB WITH AT545, 2000 TRANS 1550 SERIES**  
**With:** FEATURE 40177-02 OR 40177-08 WITH 40421-01 OR 40434-01  
**BSN:** From CSN 30043490

Key	PartNumber	Qty	Description	Comment
1	0015184	1	SHAFT ASSY,1550,COUPLING,65.27 LONG,PUR	HYD BRAKES ONLY
1	0017292	1	SHAFT ASSY,1550,COUPLING,66.37 LONG,PUR	AIR BRAKES ONLY
2	0015187	1	SHAFT ASSY,1550,MALE SLIP,44.89 LONG,PUR	
3	0015194	1	SHAFT ASSY,1550,FEMALE SLIP,67.16 LONG,	67.16 LONG
3	0039974	1	SHAFT ASSY,1550,FEMALE SLIP,65.25 LONG,	65.25 LONG
4		1	N/A	
5	0017251	2	BRACKET,MTG,DRIVELINE CENTER BEARING,	
6	0017245	2	STRAP,GUARD,DRIVELINE,10.75 LONG	
7	1987932	1	STRAP,GUARD,DRIVELINE,13.50 LONG	
8	0000096	2	BRACKET,SUPPORT,DRIVE SHAFT GUARD,HDFE	
NI	0664995		KIT,BEARING & JOURNAL 1700	UNIVERSAL JOINT. ALL LOCATIONS
10	1326610	6	STRAP,YOKE,SPICER 3-70-99	
11	1567486	12	BOLT,3/8-24 X 3/4,SPICER 6-73-412	
12	1942135	4	CAPSCREW,HEX HD 1/2-13X 1 1/4,GR8,	
13	1003045	4	WASHER,FLAT,17/32 X 1 1/16 X 7/64,HDN,	
14	2001212	4	LOCKWASHER,SPLIT RING, 1/2 ,LHT,YEL ZN	
15	1003094	4	NUT,HEX HD,1/2-13,GR 8,YEL ZN DICH	
16	1636943	4	PIN,FLG HEAD,HUCKSPIN,.50X2.22,HSP8	
17	1636968	4	COLLAR,HUCKSPIN,.50,HSCH-R16	
18	0803213	14	CAPSCREW,HEX HD,3/8-16X1 1/4,GR8,YEL	
19	1107085	28	WASHER,FLAT,13/32 X 13/16 X 3/32,HDN,BLK	
20	0826297	14	NUT,HEX HD,3/8-16 LOCK,YEL ZN DICH	

**Models:** A3FE, C3FE  
**190, 211, 232 WHEELBASE**  
**CAT C7 WITH 2500PTS TRANSMISSION**  
**With: FEATURE 40187 WITH FEATURE 40432-09**

Key	PartNumber	Qty	Description	Comment
-----	------------	-----	-------------	---------

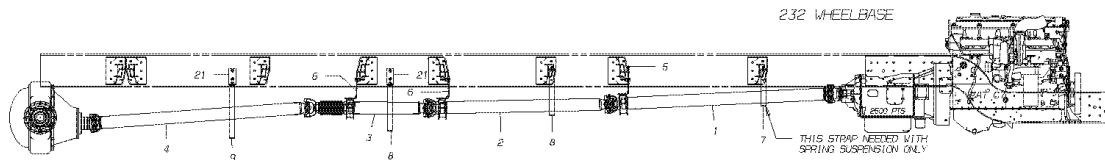
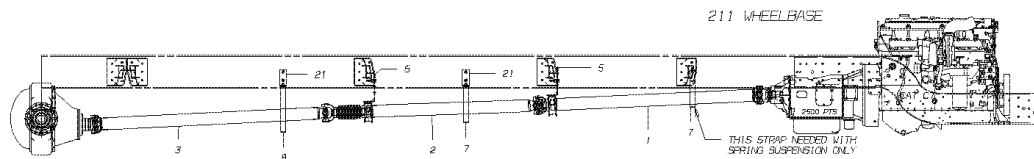
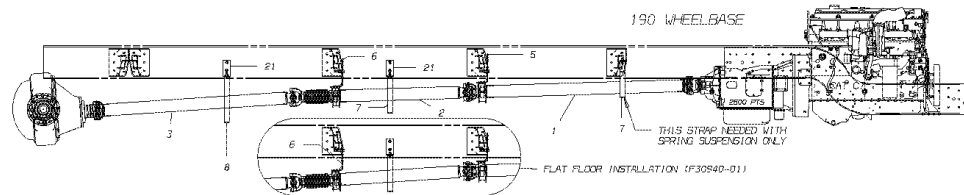
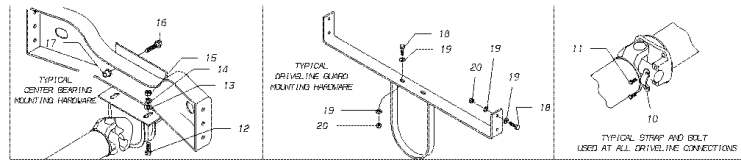

**Models:** A3FE, C3FE  
**190, 211, 232 WHEELBASE**  
**CAT C7 WITH 2500PTS TRANSMISSION**  
**With: FEATURE 40187 WITH FEATURE 40432-09**

Key	PartNumber	Qty	Description	Comment
1	0078795		SHAFT ASSY,SPL70,CPLG W/CTR BRG,65.39	65.39
1	0078794		SHAFT ASSY,SPL70,CPLG W/CTR BRG,64.20	64.20
2	0078798		SHAFT ASSY,SPL70,SLIP W/CTR BRG,50.06	
2	0078801		SHAFT ASSY,SPL70,SLIP W/CTR BRG,61.28	
2	0078793		SHAFT ASSY,SPL70,CPLG W/CTR BRG,52.59	
3	0078804		SHAFT ASSY,SPL70,CPLG W/O CTR BRG,57.82	57.82, 190 WHEELBASE
3	0057623		SHAFT ASSY,SPL70,CPLG W/O CTR BRG,55.26	55.3, 190 WHEELBASE
3	0057617		SHAFT ASSY,SPL70,CPLG W/O CTR BRG,66.87	66.9, 211 WHEELBASE
3	0057619		SHAFT ASSY,SPL70,CPLG W/O CTR BRG,65.30	65.3, 211 WHEELBASE
3	0078796		SHAFT ASSY,SPL70,SLIP W/CTR BRG,34.71	211 WHEELBASE
5	0070211		BRACKET,MTG,DRIVELINE,CENTER BEARING	211 WHEELBASE
6	0070210		BRACKET,MTG,DRIVELINE,CENTER RNG,6.63	WITH FEATURE 40072-01,-02
6	0034325		BRACKET,MTG,DRIVELINE CTR BRG,232 WB,	
6	0070210		BRACKET,MTG,DRIVELINE,CENTER RNG,6.63	WITH FEATURE 40072-01,-02
7	0017245		STRAP,GUARD,DRIVELINE,10.75 LONG	
8	1987932		STRAP,GUARD,DRIVELINE,13.50 LONG	
9	1987940		STRAP,GUARD,DRIVELINE,15.75 LONG	
10	1326610		STRAP,YOKE,SPICER 3-70-99	
11	1567486		BOLT,3/8-24 X 3/4,SPICER 6-73-412	
12	1942135		CAPSCREW,HEX HD 1/2-13X 1 1/4,GR8,	
13	1003045		WASHER,FLAT,17/32 X 1 1/16 X 7/64,HDN,	
14	2001212		LOCKWASHER,SPLIT RING, 1/2 ,LHT,YEL ZN	
15	1003094		NUT,HEX HD,1/2-13,GR 8,YEL ZN DICH	



**Models:** A3FE, C3FE  
**190, 211, 232 WHEELBASE**  
**CAT C7 WITH 2500PTS TRANSMISSION**  
**With: FEATURE 40187 WITH FEATURE 40432-09**

Key	PartNumber	Qty	Description	Comment
16	1636943		PIN,FLG HEAD,HUCKSPIN,.50X2.22,HSP8	
17	1636968		COLLAR,HUCKSPIN,.50,HSCH-R16	
18	0803213		CAPSCREW,HEX HD,3/8-16X1 1/4,GR8,YEL	
19	1107085		WASHER,FLAT,13/32 X 13/16 X 3/32,HDN,BLK	
20	0826297		NUT,HEX HD,3/8-16 LOCK,YEL ZN DICH	
21	0000096		BRACKET,SUPPORT,DRIVE SHAFT GUARD,HDFE	

**Models:** A3FE, C3FE  
**190, 211, 232 WHEELBASE**  
**CAT C7 WITH 3000PTS TRANSMISSION**  
**With: FEATURE 40187 WITH FEATURE 40432-10**

Key	PartNumber	Qty	Description	Comment
-----	------------	-----	-------------	---------

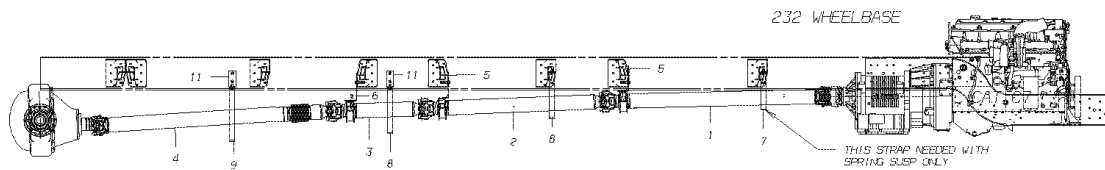
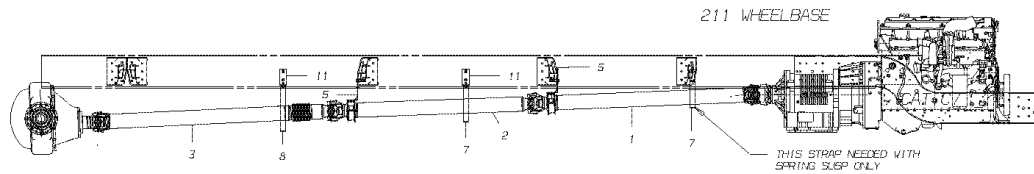
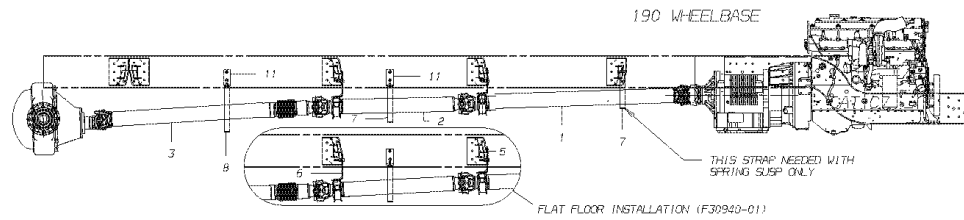
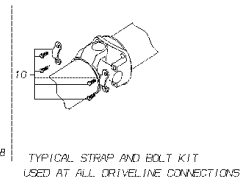
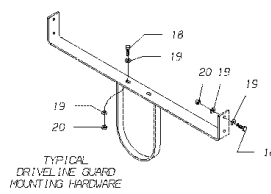
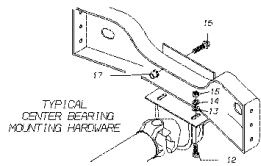

**Models:** A3FE, C3FE  
**190, 211, 232 WHEELBASE**  
**CAT C7 WITH 3000PTS TRANSMISSION**  
**With: FEATURE 40187 WITH FEATURE 40432-10**

Key	PartNumber	Qty	Description	Comment
1	0078885		SHAFT ASSY,SPL140,CPLG W/CTR BRG,65.24	
2	0078881		SHAFT ASSY,SPL140,CPLG W/CTR BRG,42.60	42.60
2	0078884		SHAFT ASSY,SPL140,CPLG W/CTR BRG,58.35	58.35
2	0078883		SHAFT ASSY,SPL140,CPLG W/CTR BRG,52.84	52.84
3	0078889		SHAFT ASSY,SPL140,SLIP W/O CTR BRG,62.99	62.99, 190 WHEELBASE
3	0078888		SHAFT ASSY,SPL140,SLIP W/O CTR BRG,60.63	60.63, 190 WHEELBASE
3	0078891		SHAFT ASSY,SPL140,SLIP W/O CTR BRG,67.91	67.91, 211 WHEELBASE
3	0078890		SHAFT ASSY,SPL140,SLIP W/O CTR BRG,66.34	66.34, 211 WHEELBASE
3	0078878		SHAFT ASSY,SPL140,CPLG W/CTR BRG,26.85	26.85, 211 WHEELBASE
5	0070211		BRACKET,MTG,DRIVELINE,CENTER BEARING	
6	0034325		BRACKET,MTG,DRIVELINE CTR BRG,232 WB,	
7	0017245		STRAP,GUARD,DRIVELINE,10.75 LONG	
8	1987932		STRAP,GUARD,DRIVELINE,13.50 LONG	
9	1987940		STRAP,GUARD,DRIVELINE,15.75 LONG	
10	0077110		KIT,STRAP,AND BOLT,140-70-18X	
11	0000096		BRACKET,SUPPORT,DRIVE SHAFT GUARD,HDFE	
12	1942135		CAPSCREW,HEX HD 1/2-13X 1 1/4,GR8,	
13	1003045		WASHER,FLAT,17/32 X 1 1/16 X 7/64,HDN,	
14	2001212		LOCKWASHER,SPLIT RING, 1/2 ,LHT,YEL ZN	
15	1003094		NUT,HEX HD,1/2-13,GR 8,YEL ZN DICH	
16	1636943		PIN,FLG HEAD,HUCKSPIN,.50X2.22,HSP8	
17	1636968		COLLAR,HUCKSPIN,.50,HSCH-R16	
18	0803213		CAPSCREW,HEX HD,3/8-16X1 1/4,GR8,YEL	

**Models:** A3FE, C3FE  
**190, 211, 232 WHEELBASE**  
**CAT C7 WITH 3000PTS TRANSMISSION**  
**With:** FEATURE 40187 WITH FEATURE 40432-10

Key	PartNumber	Qty	Description	Comment
19	1107085		WASHER,FLAT,13/32 X 13/16 X 3/32,HDN,BLK	
20	0826297		NUT,HEX HD,3/8-16 LOCK,YEL ZN DICH	

**Models:** A3FE, C3FE  
**211 WHEELBASE**  
**CAT 3126 WITH AT545, 2000 TRANS 1550 SERIES**  
**With:** FEATURE 40187-01 & 40187-08 WITH 40421-01 & 40434-01  
**BSN:** From CSN 30043490

Key	PartNumber	Qty	Description	Comment
-----	------------	-----	-------------	---------

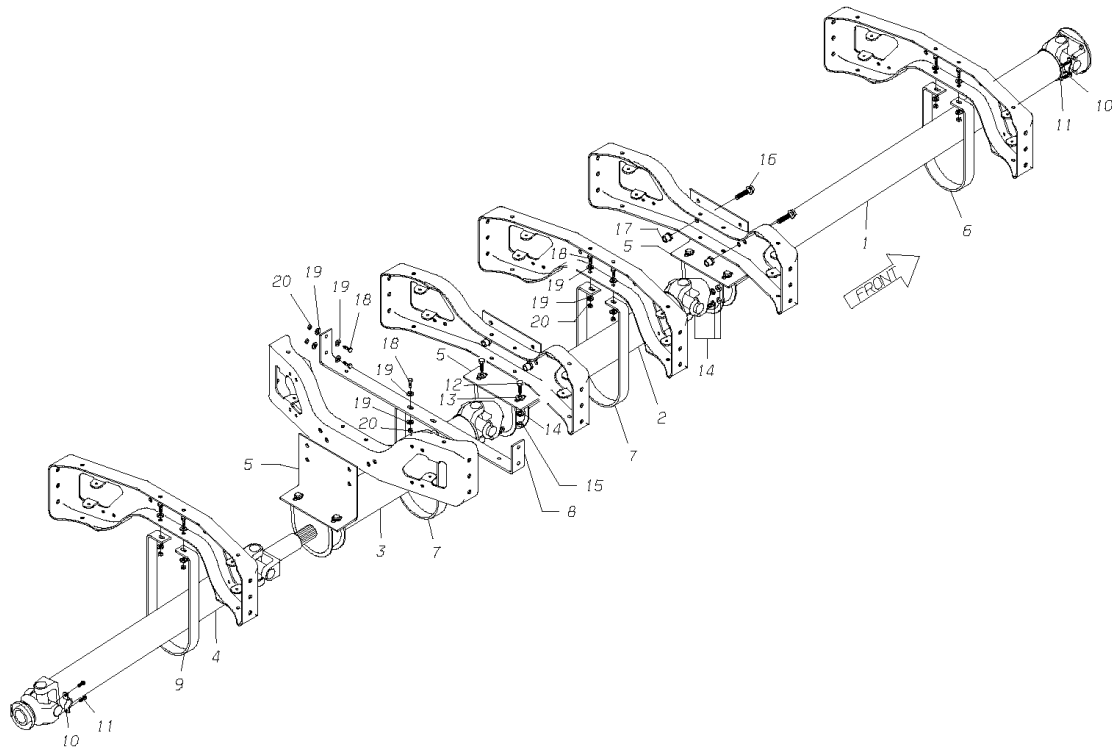

**Models:** A3FE, C3FE  
**211 WHEELBASE**  
**CAT 3126 WITH AT545, 2000 TRANS 1550 SERIES**  
**With:** FEATURE 40187-01 & 40187-08 WITH 40421-01 & 40434-01  
**BSN:** From CSN 30043490

Key	PartNumber	Qty	Description	Comment
1	0015184	1	SHAFT ASSY,1550,COUPLING,65.27 LONG,PUR	
2	0015190	1	SHAFT ASSY,1550,MALE SLIP,60.85 LONG,PUR	
3	0015196	1	SHAFT ASSY,1550,FEMALE SLIP,72.26 LG,90	WITH 19-21K AXLES
3	0039976	1	SHAFT ASSY,1550,FEMALE SLIP,70.34 LG,90	WITH 23K AXLES
5	0017251	3	BRACKET,MTG,DRIVELINE CENTER BEARING,	
6	0017245	1	STRAP,GUARD,DRIVELINE,10.75 LONG	
7	1987932	2	STRAP,GUARD,DRIVELINE,13.50 LONG	
8	0000096	2	BRACKET,SUPPORT,DRIVE SHAFT GUARD,HDFE	
NI	0664995		KIT,BEARING & JOURNAL 1700	ALL LOCATIONS
10	1326610	8	STRAP,YOKE,SPICER 3-70-99	
11	1567486	16	BOLT,3/8-24 X 3/4,SPICER 6-73-412	
12	1942135	4	CAPSCREW,HEX HD 1/2-13X 1 1/4,GR8,	
13	1003045	4	WASHER,FLAT,17/32 X 1 1/16 X 7/64,HDN,	
14	2001212	4	LOCKWASHER,SPLIT RING, 1/2 ,LHT,YEL ZN	
15	1003094	4	NUT,HEX HD,1/2-13,GR 8,YEL ZN DICH	
16	1636943	4	PIN,FLG HEAD,HUCKSPIN,.50X2.22,HSP8	
17	1636968	4	COLLAR,HUCKSPIN,.50,HSCH-R16	
18	0803213	14	CAPSCREW,HEX HD,3/8-16X1 1/4,GR8,YEL	
19	1107085	28	WASHER,FLAT,13/32 X 13/16 X 3/32,HDN,BLK	
20	0826297	14	NUT,HEX HD,3/8-16 LOCK,YEL ZN DICH	

**Models:** A3FE, C3FE  
**211 WHEELBASE**  
**CAT 3126 WITH MT643 TRANS 1610 SERIES**  
**BSN:** From CSN 30087475

Key	PartNumber	Qty	Description	Comment
-----	------------	-----	-------------	---------

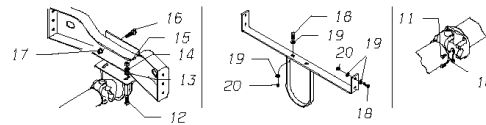

190 WHEELBASE

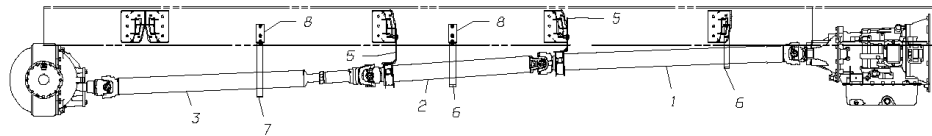

211 WHEELBASE

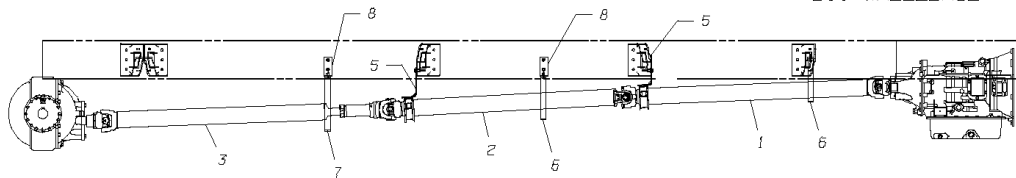

232 WHEELBASE

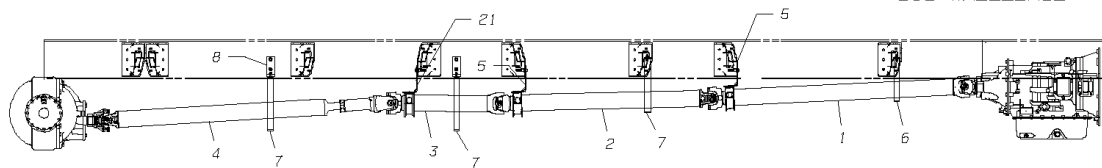

**Models:** A3FE, C3FE  
**211 WHEELBASE**  
**CAT 3126 WITH MT643 TRANS 1610 SERIES**  
**BSN: From CSN 30087475**

Key	PartNumber	Qty	Description	Comment
1	0000990	1	SHAFT ASSY,1610,62.720,PTD	
2	1967702	1	SHAFT ASSY,1610,NO.2,PAINTED,211 WB,	
3	1570464	1	SHAFT ASSY,1610,SLIP,L=69.00,PAINTED	WITH ALL AXLES
5	0017249	2	BRACKET,MTG,DRIVELINE CENTER BEARING,	
6	0017245	2	STRAP,GUARD,DRIVELINE,10.75 LONG	
7	1987932	1	STRAP,GUARD,DRIVELINE,13.50 LONG	
8	0000096	2	BRACKET,SUPPORT,DRIVE SHAFT GUARD,HDFE	
9	1708239	12	BOLT 5/16-24,SELF LOCKING,SPICER 5-73-709	
10	1326610	2	STRAP,YOKE,SPICER 3-70-99	
11	1567486	4	BOLT,3/8-24 X 3/4,SPICER 6-73-412	
12	1942135	4	CAPSCREW,HEX HD 1/2-13X 1 1/4,GR8,	
13	1003045	4	WASHER,FLAT,17/32 X 1 1/16 X 7/64,HDN,	
14	2001212	4	LOCKWASHER,SPLIT RING, 1/2 ,LHT,YEL ZN	
15	1003094	4	NUT,HEX HD,1/2-13,GR 8,YEL ZN DICH	
16	1636943	4	PIN,FLG HEAD,HUCKSPIN,.50X2.22,HSP8	
17	1636968	4	COLLAR,HUCKSPIN,.50,HSCH-R16	
18	0803213	14	CAPSCREW,HEX HD,3/8-16X1 1/4,GR8,YEL	
19	1107085	28	WASHER,FLAT,13/32 X 13/16 X 3/32,HDN,BLK	
20	0826297	14	NUT,HEX HD,3/8-16 LOCK,YEL ZN DICH	



**Models:** A3FE, C3FE  
**211 WHEELBASE**  
**CUMMINS ISB WITH AT545, 2000 TRANS 1550 SERIES**  
**With:** FEATURE 40177-02 OR 40177-08 WITH 40421-01 OR 40434-01  
**BSN:** From CSN 30043490

Key	PartNumber	Qty	Description	Comment
-----	------------	-----	-------------	---------

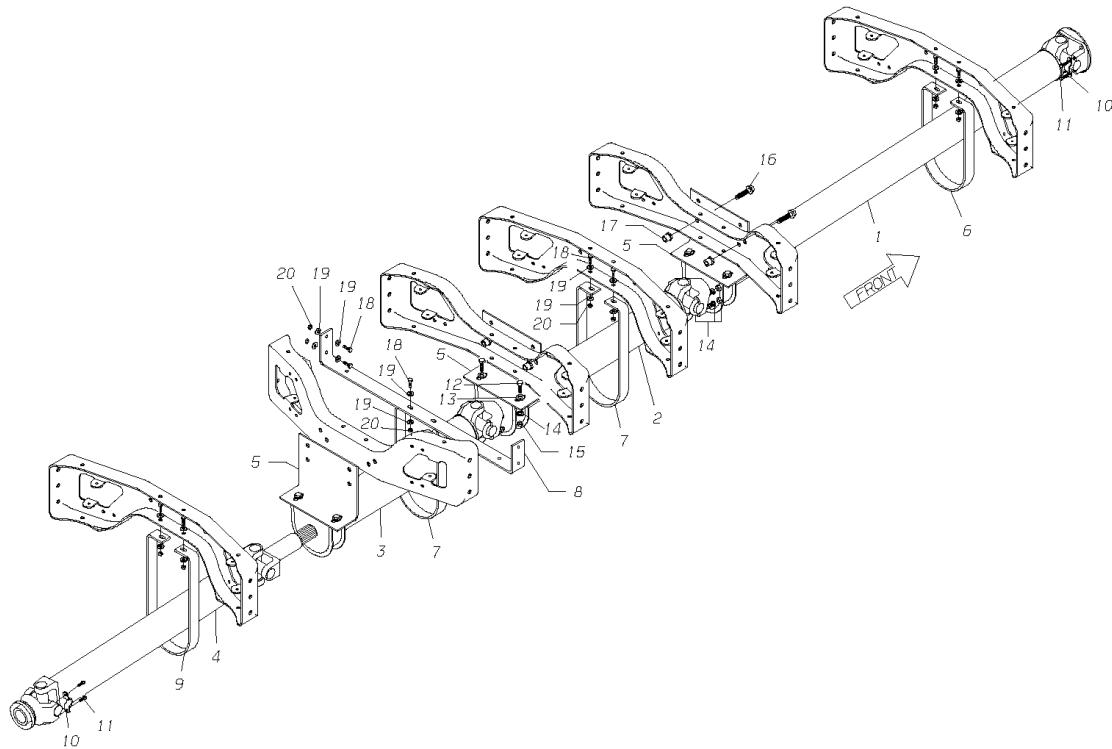

**Models:** A3FE, C3FE  
**211 WHEELBASE**  
**CUMMINS ISB WITH AT545, 2000 TRANS 1550 SERIES**  
**With:** FEATURE 40177-02 OR 40177-08 WITH 40421-01 OR 40434-01  
**BSN:** From CSN 30043490

Key	PartNumber	Qty	Description	Comment
1	0015184	1	SHAFT ASSY,1550,COUPLING,65.27 LONG,PUR	HYD BRAKES ONLY
1	0017292	1	SHAFT ASSY,1550,COUPLING,66.37 LONG,PUR	AIR BRAKES ONLY
2	0015190	1	SHAFT ASSY,1550,MALE SLIP,60.85 LONG,PUR	
3	0015196	1	SHAFT ASSY,1550,FEMALE SLIP,72.26 LG,90	72.26 LONG
3	0039976	1	SHAFT ASSY,1550,FEMALE SLIP,70.34 LG,90	70.34 LONG
4		1	N/A	
5	0017251	2	BRACKET,MTG,DRIVELINE CENTER BEARING,	
6	0017245	2	STRAP,GUARD,DRIVELINE,10.75 LONG	
7	1987932	1	STRAP,GUARD,DRIVELINE,13.50 LONG	
8	0000096	2	BRACKET,SUPPORT,DRIVE SHAFT GUARD,HDFE	
NI	0664995		KIT,BEARING & JOURNAL 1700	ALL LOCATIONS
10	1326610	6	STRAP,YOKE,SPICER 3-70-99	
11	1567486	12	BOLT,3/8-24 X 3/4,SPICER 6-73-412	
12	1942135	4	CAPSCREW,HEX HD 1/2-13X 1 1/4,GR8,	
13	1003045	4	WASHER,FLAT,17/32 X 1 1/16 X 7/64,HDN,	
14	2001212	4	LOCKWASHER,SPLIT RING, 1/2 ,LHT,YEL ZN	
15	1003094	4	NUT,HEX HD,1/2-13,GR 8,YEL ZN DICH	
16	1636943	4	PIN,FLG HEAD,HUCKSPIN,.50X2.22,HSP8	
17	1636968	4	COLLAR,HUCKSPIN,.50,HSCH-R16	
18	0803213	14	CAPSCREW,HEX HD,3/8-16X1 1/4,GR8,YEL	
19	1107085	28	WASHER,FLAT,13/32 X 13/16 X 3/32,HDN,BLK	
20	0826297	14	NUT,HEX HD,3/8-16 LOCK,YEL ZN DICH	

**Models:** A3FE, C3FE  
**211 WHEELBASE**  
**CUMMINS ISB/ISC WITH MT643 TRANS 1610 SERIES**  
**BSN:** From CSN 30087475

Key	PartNumber	Qty	Description	Comment
-----	------------	-----	-------------	---------

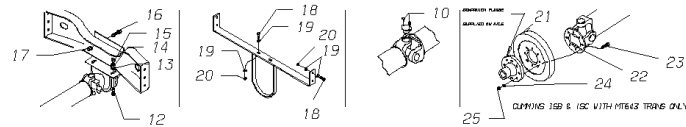

190 WHEELBASE

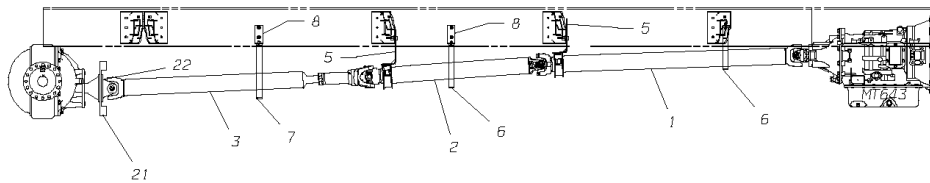

211 WHEELBASE

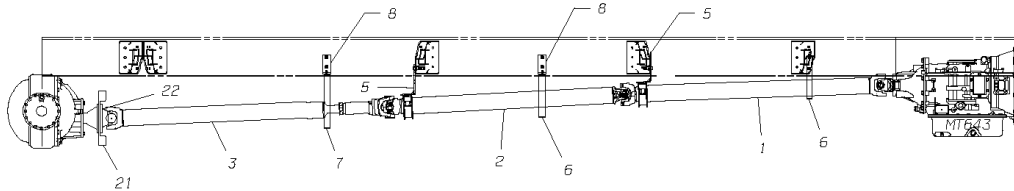

232 WHEELBASE

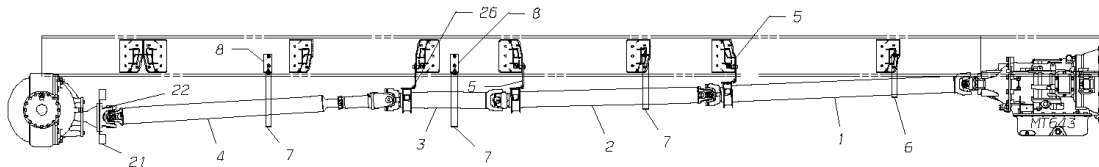

**Models:** A3FE, C3FE  
**211 WHEELBASE**  
**CUMMINS ISB/ISC WITH MT643 TRANS 1610 SERIES**  
**BSN:** From CSN 30087475

Key	PartNumber	Qty	Description	Comment
1	1609817	1	SHAFT ASSY,1610,L=63.406,PTD, TCFC	<i>ISB ONLY</i>
1	1240076	1	SHAFT ASSY,1610,NO 2&3 SHAFT,60 LG,PNTD	<i>ISC ONLY</i>
2	1967702	1	SHAFT ASSY,1610,NO.2,PAINTED,211 WB,	
3	1607571	1	SHAFT ASSY,1610,SLIP,L=68.50,PTD, TCFC	<i>WITH 19-21K AXLES</i>
3	0039809	1	SHAFT ASSY,1610,SLIP TYPE,FULL RD,L-66.50	<i>WITH 23K AXLE</i>
5	0017249	2	BRACKET,MTG,DRIVELINE CENTER BEARING,	
6	0017245	2	STRAP,GUARD,DRIVELINE,10.75 LONG	
7	1987932	1	STRAP,GUARD,DRIVELINE,13.50 LONG	
8	0000096	2	BRACKET,SUPPORT,DRIVE SHAFT GUARD,HDFE	
10	1708239	16	BOLT 5/16-24,SELF LOCKING,SPICER 5-73-709	
12	1942135	4	CAPSCREW,HEX HD 1/2-13X 1 1/4,GR8,	
13	1003045	4	WASHER,FLAT,17/32 X 1 1/16 X 7/64,HDN,	
14	2001212	4	LOCKWASHER,SPLIT RING, 1/2 ,LHT,YEL ZN	
15	1003094	4	NUT,HEX HD,1/2-13,GR 8,YEL ZN DICH	
16	1636943	4	PIN,FLG HEAD,HUCKSPIN,.50X2.22,HSP8	
17	1636968	4	COLLAR,HUCKSPIN,.50,HSCH-R16	
18	0803213	14	CAPSCREW,HEX HD,3/8-16X1 1/4,GR8,YEL	
19	1107085	28	WASHER,FLAT,13/32 X 13/16 X 3/32,HDN,BLK	
20	0826297	14	NUT,HEX HD,3/8-16 LOCK,YEL ZN DICH	
21	1308584	1	DAMPER,TORSIONAL,STAHL 630103	
22	1035732	1	YOKE,FLANGE,BRG PLT CONST SPCR 5-2-279	
23	1267442	8	CAPSCREW,HEX HD,3/8-24 X 2 ,GR8,YEL ZN	
24	0882795	8	LOCKWASHER,SPLIT RING,3/8,MED,YELLOW	

**Models:** A3FE, C3FE  
211 WHEELBASE  
CUMMINS ISB/ISC WITH MT643 TRANS 1610 SERIES  
**BSN:** From CSN 30087475

Key	PartNumber	Qty	Description	Comment
25	0803189	8	NUT,HEX,3/8-24,GR8,BLACK ZINC	

**Models:** A3FE, C3FE  
**211 WHEELBASE**  
**MD3060/B300 TRANS 1610 SERIES**  
**BSN:** From CSN 30087475

Key	PartNumber	Qty	Description	Comment
-----	------------	-----	-------------	---------

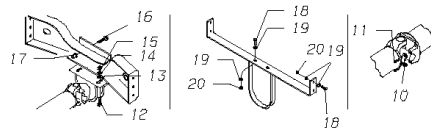

190 WHEELBASE

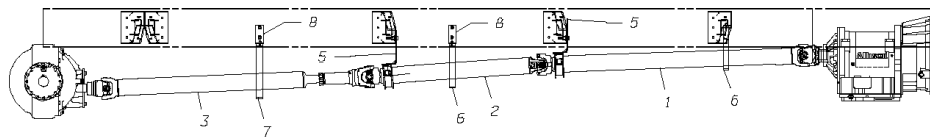

211 WHEELBASE

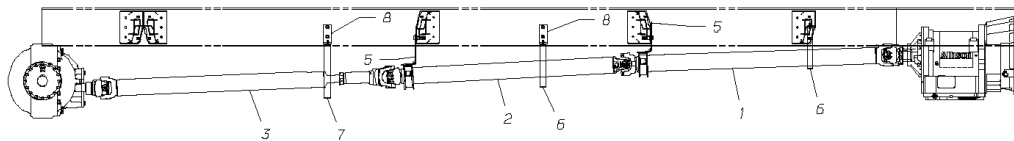

232 WHEELBASE

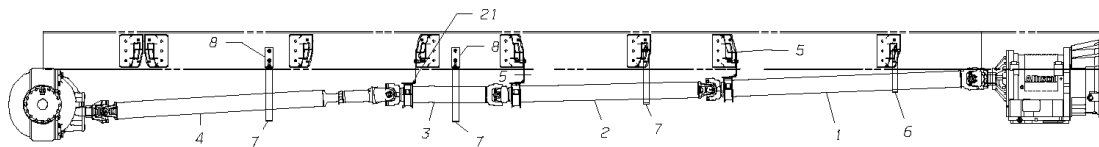

**Models:** A3FE, C3FE  
**211 WHEELBASE**  
**MD3060/B300 TRANS 1610 SERIES**  
**BSN:** From CSN 30087475

Key	PartNumber	Qty	Description	Comment
1	0048648	1	SHAFT ASSY,1610,PROP,L=65.00,PUR	ISB ONLY
1	0048646	1	SHAFT ASSY,1610,PROP,L=62.00,PUR	ISC ONLY
1	0048647	1	SHAFT ASSY,1610,PROP,L=64.50,PUR	CAT ONLY
2	1967702	1	SHAFT ASSY,1610,NO.2,PAINTED,211 WB,	
3	1570464	1	SHAFT ASSY,1610,SLIP,L=69.00,PAINTED	WITH ALL AXLES
5	0017249	2	BRACKET,MTG,DRIVELINE CENTER BEARING,	
6	0017245	2	STRAP,GUARD,DRIVELINE,10.75 LONG	
7	1987932	1	STRAP,GUARD,DRIVELINE,13.50 LONG	
8	0000096	2	BRACKET,SUPPORT,DRIVE SHAFT GUARD,HDFE	
9	1708239	8	BOLT 5/16-24,SELF LOCKING,SPICER 5-73-709	
10	1326610	4	STRAP,YOKE,SPICER 3-70-99	
11	1567486	8	BOLT,3/8-24 X 3/4,SPICER 6-73-412	
12	1942135	4	CAPSCREW,HEX HD 1/2-13X 1 1/4,GR8,	
13	1003045	4	WASHER,FLAT,17/32 X 1 1/16 X 7/64,HDN,	
14	2001212	4	LOCKWASHER,SPLIT RING, 1/2 ,LHT,YEL ZN	
15	1003094	4	NUT,HEX HD,1/2-13,GR 8,YEL ZN DICH	
16	1636943	4	PIN,FLG HEAD,HUCKSPIN,.50X2.22,HSP8	
17	1636968	4	COLLAR,HUCKSPIN,.50,HSCH-R16	
18	0803213	14	CAPSCREW,HEX HD,3/8-16X1 1/4,GR8,YEL	
19	1107085	28	WASHER,FLAT,13/32 X 13/16 X 3/32,HDN,BLK	
20	0826297	14	NUT,HEX HD,3/8-16 LOCK,YEL ZN DICH	

**Models:** A3FE, C3FE  
**232 WHEELBASE**  
**CAT 3126 WITH AT545, 2000 TRANS 1550 SERIES**  
**With:** FEATURE 40187-01 & 40187-08 WITH 40421-01 & 40434-01  
**BSN:** From CSN 30043490

Key	PartNumber	Qty	Description	Comment
-----	------------	-----	-------------	---------

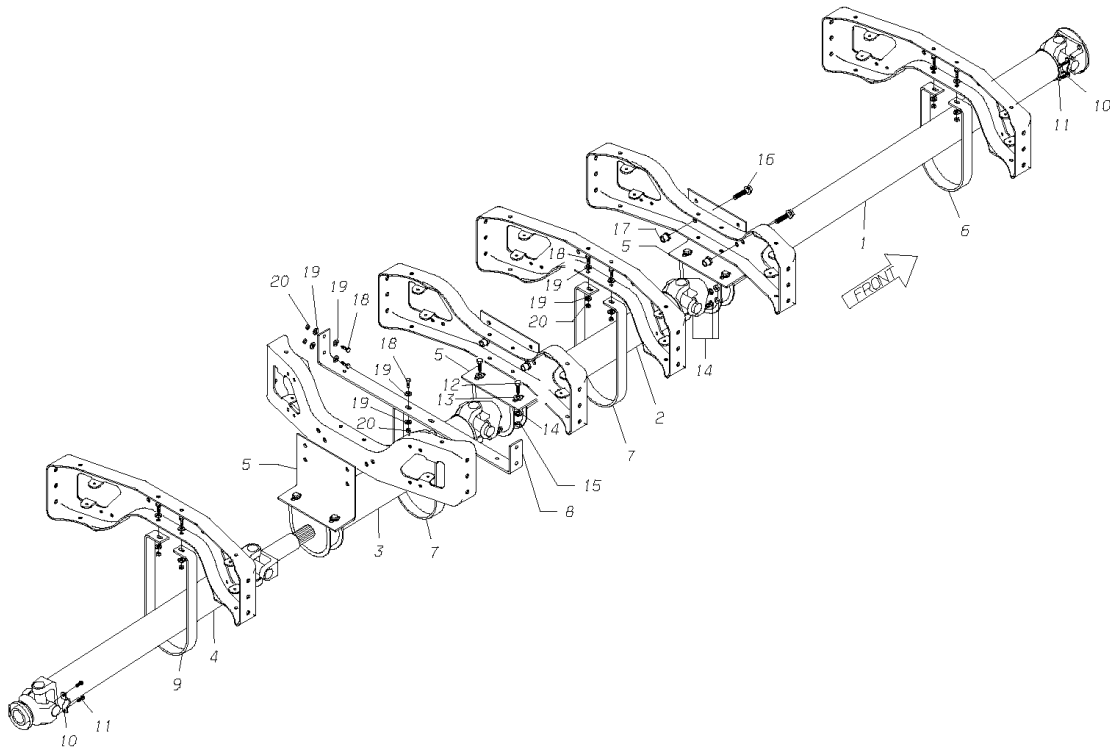



**Models:** A3FE, C3FE  
**232 WHEELBASE**  
**CAT 3126 WITH AT545, 2000 TRANS 1550 SERIES**  
**With:** FEATURE 40187-01 & 40187-08 WITH 40421-01 & 40434-01  
**BSN:** From CSN 30043490

Key	PartNumber	Qty	Description	Comment
1	0015184	1	SHAFT ASSY,1550,COUPLING,65.27 LONG,PUR	
2	0015182	1	SHAFT ASSY,1550,COUPLING,52.45 LONG,PUR	
3	0015185	1	SHAFT ASSY,1550,MALE SLIP,32.14 LONG,PUR	
4	0015195	1	SHAFT ASSY,1550,FEMALE SLIP,69.12 LG,90	WITH 19-21K AXLES
4	0039976	1	SHAFT ASSY,1550,FEMALE SLIP,70.34 LG,90	WITH 23K AXLES
5	0017252	3	BRACKET,MTG,DRIVELINE CENTER BEARING,	
6	0017245	1	STRAP,GUARD,DRIVELINE,10.75 LONG	
7	1987932	2	STRAP,GUARD,DRIVELINE,13.50 LONG	
8	0000096	2	BRACKET,SUPPORT,DRIVE SHAFT GUARD,HDFE	
9	1987940	1	STRAP,GUARD,DRIVELINE,15.75 LONG	
NI	0664995	6	KIT,BEARING & JOURNAL 1700	ALL LOCATIONS
10	1326610	8	STRAP,YOKE,SPICER 3-70-99	
11	1567486	16	BOLT,3/8-24 X 3/4,SPICER 6-73-412	
12	1942135	6	CAPSCREW,HEX HD 1/2-13X 1 1/4,GR8,	
13	1003045	6	WASHER,FLAT,17/32 X 1 1/16 X 7/64,HDN,	
14	2001212	6	LOCKWASHER,SPLIT RING, 1/2 ,LHT,YEL ZN	
15	1003094	6	NUT,HEX HD,1/2-13,GR 8,YEL ZN DICH	
16	1636943	6	PIN,FLG HEAD,HUCKSPIN,.50X2.22,HSP8	
17	1636968	6	COLLAR,HUCKSPIN,.50,HSCH-R16	
18	0803213	16	CAPSCREW,HEX HD,3/8-16X1 1/4,GR8,YEL	
19	1107085	32	WASHER,FLAT,13/32 X 13/16 X 3/32,HDN,BLK	
20	0826297	16	NUT,HEX HD,3/8-16 LOCK,YEL ZN DICH	

**Models:** A3FE, C3FE  
**232 WHEELBASE**  
**CAT 3126 WITH MT643 TRANS 1610 SERIES**  
**BSN:** From CSN 30087475

Key	PartNumber	Qty	Description	Comment
-----	------------	-----	-------------	---------

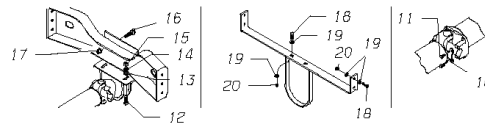

190 WHEELBASE

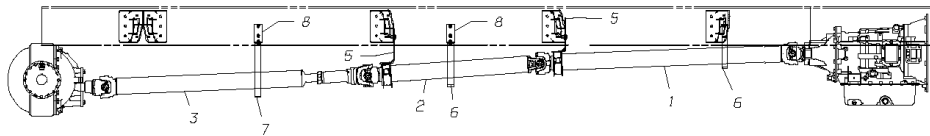

211 WHEELBASE

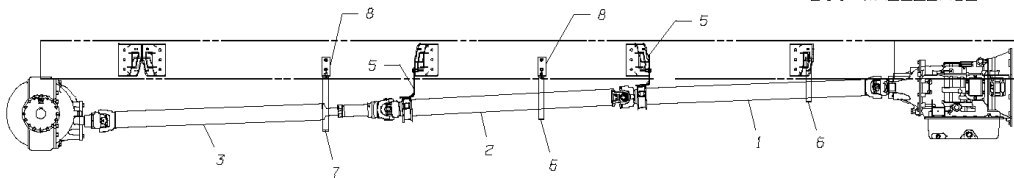

232 WHEELBASE

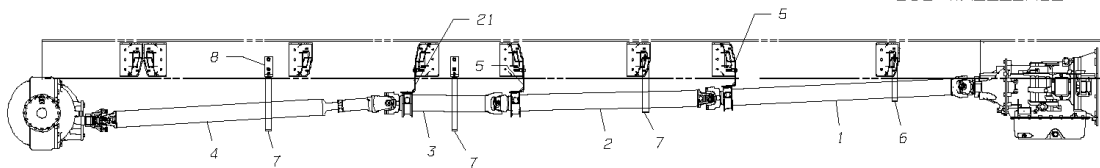

**Models:** A3FE, C3FE  
**232 WHEELBASE**  
**CAT 3126 WITH MT643 TRANS 1610 SERIES**  
**BSN:** From CSN 30087475

Key	PartNumber	Qty	Description	Comment
1	0000990	1	SHAFT ASSY,1610,62.720,PTD	
2	1240068	1	SHAFT ASSY,1610,NO 2&3 SHAFT,52 1/2 LG,	
3	1967686	1	SHAFT ASSY,1610,NO.3,PAINTED,232 WB,	
4	1570464	1	SHAFT ASSY,1610,SLIP,L=69.00,PAINTED	WITH ALL AXLES
5	1514751	2	BRACKET,SUPT,M/S BRG,FRMD,1610,TCFC	
6	0017245	1	STRAP,GUARD,DRIVELINE,10.75 LONG	
7	1987932	3	STRAP,GUARD,DRIVELINE,13.50 LONG	
8	0000096	2	BRACKET,SUPPORT,DRIVE SHAFT GUARD,HDFE	
9	1708239	12	BOLT 5/16-24,SELF LOCKING,SPICER 5-73-709	
10	1326610	2	STRAP,YOKE,SPICER 3-70-99	
11	1567486	6	BOLT,3/8-24 X 3/4,SPICER 6-73-412	
12	1942135	6	CAPSCREW,HEX HD 1/2-13X 1 1/4,GR8,	
13	1003045	6	WASHER,FLAT,17/32 X 1 1/16 X 7/64,HDN,	
14	2001212	6	LOCKWASHER,SPLIT RING, 1/2 ,LHT,YEL ZN	
15	1003094	6	NUT,HEX HD,1/2-13,GR 8,YEL ZN DICH	
16	1636943	6	PIN,FLG HEAD,HUCKSPIN,.50X2.22,HSP8	
17	1636968	6	COLLAR,HUCKSPIN,.50,HSCH-R16	
18	0803213	16	CAPSCREW,HEX HD,3/8-16X1 1/4,GR8,YEL	
19	1107085	32	WASHER,FLAT,13/32 X 13/16 X 3/32,HDN,BLK	
20	0826297	16	NUT,HEX HD,3/8-16 LOCK,YEL ZN DICH	
21	0034325	1	BRACKET,MTG,DRIVELINE CTR BRG,232 WB,	

**Models:** A3FE, C3FE  
**232 WHEELBASE**  
**CUMMINS ISB WITH AT545, 2000 TRANS 1550 SERIES**  
**With:** FEATURE 40177-02 OR 40177-08 WITH 40421-01 OR 40434-01  
**BSN:** From CSN 30043490

Key	PartNumber	Qty	Description	Comment
-----	------------	-----	-------------	---------

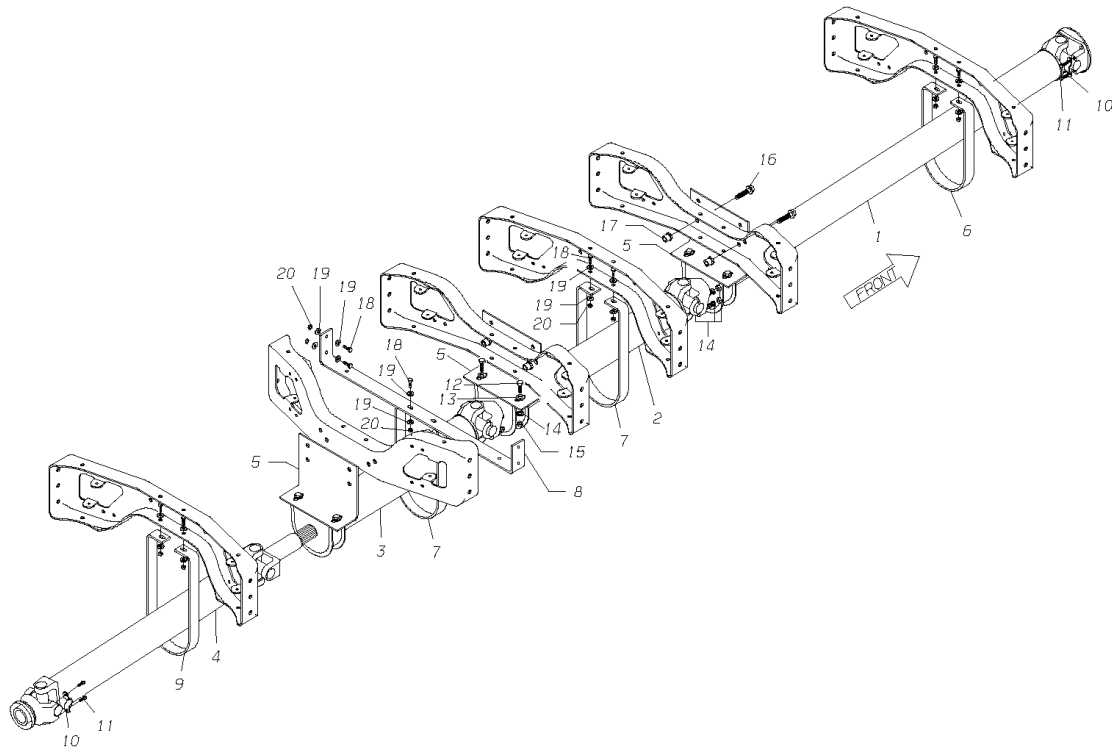

**Models:** A3FE, C3FE  
**232 WHEELBASE**  
**CUMMINS ISB WITH AT545, 2000 TRANS 1550 SERIES**  
**With:** FEATURE 40177-02 OR 40177-08 WITH 40421-01 OR 40434-01  
**BSN:** From CSN 30043490

Key	PartNumber	Qty	Description	Comment
1	0015184	1	SHAFT ASSY,1550,COUPLING,65.27 LONG,PUR	HYD BRAKES ONLY
1	0017292	1	SHAFT ASSY,1550,COUPLING,66.37 LONG,PUR	AIR BRAKES ONLY
2	0015182	1	SHAFT ASSY,1550,COUPLING,52.45 LONG,PUR	
3	0015185	1	SHAFT ASSY,1550,MALE SLIP,32.14 LONG,PUR	
4	0015195	1	SHAFT ASSY,1550,FEMALE SLIP,69.12 LG,90	69.52 LONG
4	0018492	1	SHAFT ASSY,1550,FEMALE SLIP,67.16 LG,90	67.16 LONG
5	0017252	3	BRACKET,MTG,DRIVELINE CENTER BEARING,	
6	0017245	1	STRAP,GUARD,DRIVELINE,10.75 LONG	
7	1987932	2	STRAP,GUARD,DRIVELINE,13.50 LONG	
8	0000096	2	BRACKET,SUPPORT,DRIVE SHAFT GUARD,HDFE	
9	1987940	1	STRAP,GUARD,DRIVELINE,15.75 LONG	
NI	0664995	6	KIT,BEARING & JOURNAL 1700	ALL LOCATIONS
10	1326610	8	STRAP,YOKE,SPICER 3-70-99	
11	1567486	16	BOLT,3/8-24 X 3/4,SPICER 6-73-412	
12	1942135	6	CAPSCREW,HEX HD 1/2-13X 1 1/4,GR8,	
13	1003045	6	WASHER,FLAT,17/32 X 1 1/16 X 7/64,HDN,	
14	2001212	6	LOCKWASHER,SPLIT RING, 1/2 ,LHT,YEL ZN	
15	1003094	6	NUT,HEX HD,1/2-13,GR 8,YEL ZN DICH	
16	1636943	6	PIN,FLG HEAD,HUCKSPIN,.50X2.22,HSP8	
17	1636968	6	COLLAR,HUCKSPIN,.50,HSCH-R16	
18	0803213	16	CAPSCREW,HEX HD,3/8-16X1 1/4,GR8,YEL	
19	1107085	32	WASHER,FLAT,13/32 X 13/16 X 3/32,HDN,BLK	
20	0826297	16	NUT,HEX HD,3/8-16 LOCK,YEL ZN DICH	

**Models:** A3FE, C3FE  
**232 WHEELBASE**  
**CUMMINS ISB/ISC WITH MT643 TRANS 1610 SERIES**  
**BSN:** From CSN 30087475

Key	PartNumber	Qty	Description	Comment
-----	------------	-----	-------------	---------

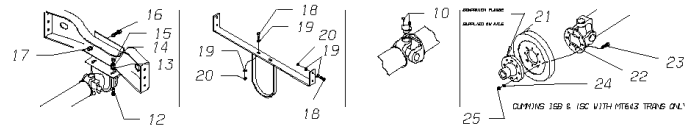

190 WHEELBASE

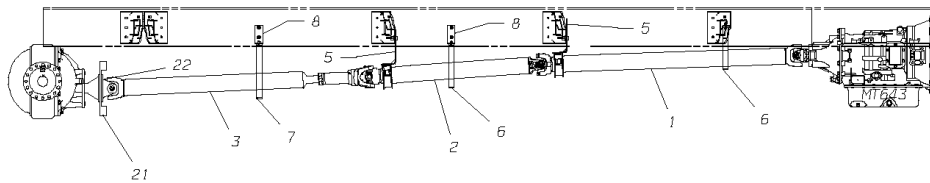

211 WHEELBASE

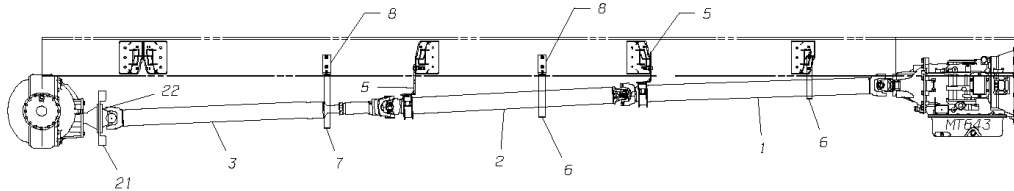

232 WHEELBASE

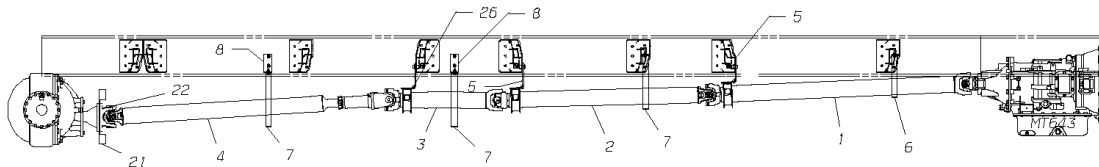

**Models:** A3FE, C3FE  
**232 WHEELBASE**  
**CUMMINS ISB/ISC WITH MT643 TRANS 1610 SERIES**  
**BSN:** From CSN 30087475

Key	PartNumber	Qty	Description	Comment
1	1609817	1	SHAFT ASSY,1610,L=63.406,PTD, TCFC	ISB ONLY
1	1240076	1	SHAFT ASSY,1610,NO 2&3 SHAFT,60 LG,PNTD	ISC ONLY
2	1240068	1	SHAFT ASSY,1610,NO 2&3 SHAFT,52 1/2 LG,	
3	1967686	1	SHAFT ASSY,1610,NO.3,PAINTED,232 WB,	
4	1607571	1	SHAFT ASSY,1610,SLIP,L=68.50,PTD, TCFC	WITH 19-21K AXLES
4	0039809	1	SHAFT ASSY,1610,SLIP TYPE,FULL RD,L-66.50	WITH 23K AXLE
5	1514751	2	BRACKET,SUPT,M/S BRG,FRMD,1610,TCFC	
6	0017245	1	STRAP,GUARD,DRIVELINE,10.75 LONG	
7	1987932	3	STRAP,GUARD,DRIVELINE,13.50 LONG	
8	0000096	2	BRACKET,SUPPORT,DRIVE SHAFT GUARD,HDFE	
10	1708239	20	BOLT 5/16-24,SELF LOCKING,SPICER 5-73-709	
12	1942135	4	CAPSCREW,HEX HD 1/2-13X 1 1/4,GR8,	
13	1003045	4	WASHER,FLAT,17/32 X 1 1/16 X 7/64,HDN,	
14	2001212	4	LOCKWASHER,SPLIT RING, 1/2 ,LHT,YEL ZN	
15	1003094	4	NUT,HEX HD,1/2-13,GR 8,YEL ZN DICH	
16	1636943	4	PIN,FLG HEAD,HUCKSPIN,.50X2.22,HSP8	
17	1636968	4	COLLAR,HUCKSPIN,.50,HSCH-R16	
18	0803213	16	CAPSCREW,HEX HD,3/8-16X1 1/4,GR8,YEL	
19	1107085	32	WASHER,FLAT,13/32 X 13/16 X 3/32,HDN,BLK	
20	0826297	16	NUT,HEX HD,3/8-16 LOCK,YEL ZN DICH	
21	1308584	1	DAMPER,TORSIONAL,STAHL 630103	
22	1035732	1	YOKE,FLANGE,BRG PLT CONST SPCR 5-2-279	
23	1267442	8	CAPSCREW,HEX HD,3/8-24 X 2 ,GR8,YEL ZN	

**Models:** A3FE, C3FE  
232 WHEELBASE  
CUMMINS ISB/ISC WITH MT643 TRANS 1610 SERIES  
**BSN:** From CSN 30087475

Key	PartNumber	Qty	Description	Comment
24	0882795	8	LOCKWASHER,SPLIT RING,3/8,MED,YELLOW	
25	0803189	8	NUT,HEX,3/8-24,GR8,BLACK ZINC	
26	0034325	1	BRACKET,MTG,DRIVELINE CTR BRG,232 WB,	



**Models:** A3FE, C3FE  
**232 WHEELBASE**  
**MD3060/B300 TRANS 1610 SERIES**  
**BSN:** From CSN 30087475

Key	PartNumber	Qty	Description	Comment
-----	------------	-----	-------------	---------

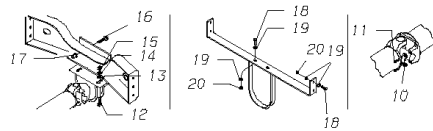

190 WHEELBASE

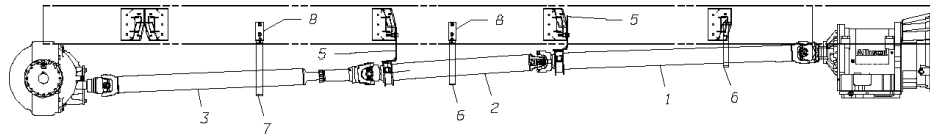

211 WHEELBASE

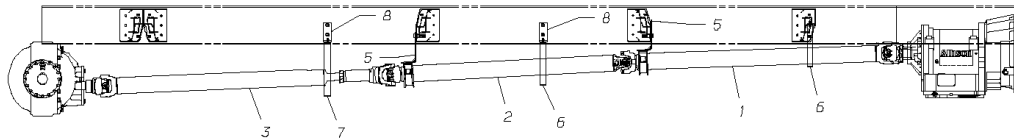

232 WHEELBASE

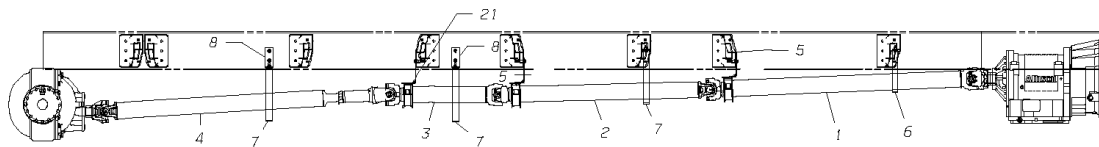

**Models:** A3FE, C3FE  
**232 WHEELBASE**  
**MD3060/B300 TRANS 1610 SERIES**  
**BSN:** From CSN 30087475

Key	PartNumber	Qty	Description	Comment
1	0048648	1	SHAFT ASSY,1610,PROP,L=65.00,PUR	ISB ONLY
1	0048646	1	SHAFT ASSY,1610,PROP,L=62.00,PUR	ISC ONLY
1	0048647	1	SHAFT ASSY,1610,PROP,L=64.50,PUR	CAT ONLY
2	1240068	1	SHAFT ASSY,1610,NO 2&3 SHAFT,52 1/2 LG,	
3	1967686	1	SHAFT ASSY,1610,NO.3,PAINTED,232 WB,	
4	0015195	1	SHAFT ASSY,1550,FEMALE SLIP,69.12 LG,90	WITH ALL AXLES)
5	1514751	2	BRACKET,SUPT,M/S BRG,FRMD,1610,TCFC	
6	0017245	1	STRAP,GUARD,DRIVELINE,10.75 LONG	
7	1987932	2	STRAP,GUARD,DRIVELINE,13.50 LONG	
8	0000096	2	BRACKET,SUPPORT,DRIVE SHAFT GUARD,HDFE	
9	1708239	12	BOLT 5/16-24,SELF LOCKING,SPICER 5-73-709	
10	1326610	6	STRAP,YOKE,SPICER 3-70-99	
11	1567486	12	BOLT,3/8-24 X 3/4,SPICER 6-73-412	
12	1942135	6	CAPSCREW,HEX HD 1/2-13X 1 1/4,GR8,	
13	1003045	6	WASHER,FLAT,17/32 X 1 1/16 X 7/64,HDN,	
14	2001212	6	LOCKWASHER,SPLIT RING, 1/2 ,LHT,YEL ZN	
15	1003094	6	NUT,HEX HD,1/2-13,GR 8,YEL ZN DICH	
16	1636943	6	PIN,FLG HEAD,HUCKSPIN,.50X2.22,HSP8	
17	1636968	6	COLLAR,HUCKSPIN,.50,HSCH-R16	
18	0803213	16	CAPSCREW,HEX HD,3/8-16X1 1/4,GR8,YEL	
19	1107085	32	WASHER,FLAT,13/32 X 13/16 X 3/32,HDN,BLK	
20	0826297	16	NUT,HEX HD,3/8-16 LOCK,YEL ZN DICH	
21	0034325	1	BRACKET,MTG,DRIVELINE CTR BRG,232 WB,	

**Models:** A3FE, C3FE  
**232 WHEELBASE**  
**MD3060/B400 TRANS 1710 SERIES**  
**BSN:** From CSN 30087475

Key	PartNumber	Qty	Description	Comment
-----	------------	-----	-------------	---------

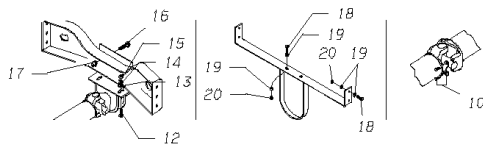

190 WHEELBASE

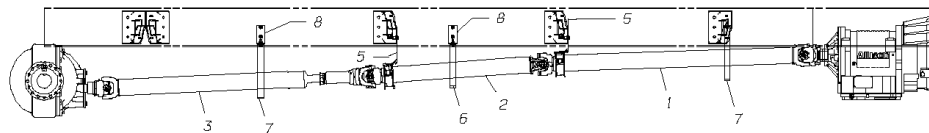

211 WHEELBASE

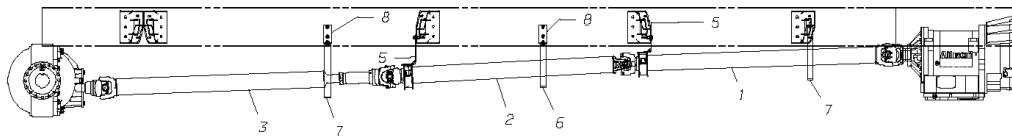

232 WHEELBASE

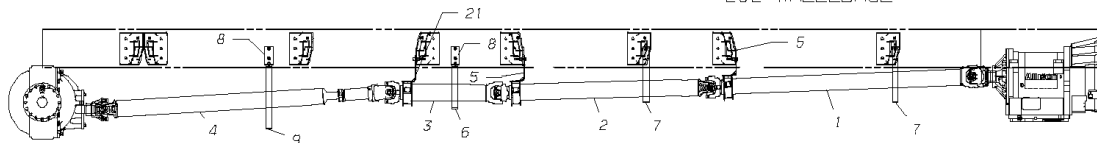

**Models:** A3FE, C3FE  
**232 WHEELBASE**  
**MD3060/B400 TRANS 1710 SERIES**  
**BSN:** From CSN 30087475

Key	PartNumber	Qty	Description	Comment
1	0004981	1	SHAFT ASSY,1710,63.75,PTD	ISC ONLY
1	0003912	1	SHAFT ASSY,1710,66.14,PTD	CAT ONLY
2	1979343	1	SHAFT ASSY, 1710,52,15, PTD	
3	0003918	1	SHAFT ASSY,1710,27.10,PTD	
4	0003925	1	SHAFT ASSY,1710,SLIP,65.84,PTD	WITH ALL AXLES
5	1514751	2	BRACKET,SUPT,M/S BRG,FRMD,1610,TCFC	
6	0017245	1	STRAP,GUARD,DRIVELINE,10.75 LONG	
7	1987932	2	STRAP,GUARD,DRIVELINE,13.50 LONG	
8	0000096	2	BRACKET,SUPPORT,DRIVE SHAFT GUARD,HDFE	
9	1987940	1	STRAP,GUARD,DRIVELINE,15.75 LONG	
10	1631506	5	KIT,STRAP AND BOLT,6.5-70-18X	
12	1942135	6	CAPSCREW,HEX HD 1/2-13X 1 1/4,GR8,	
13	1003045	6	WASHER,FLAT,17/32 X 1 1/16 X 7/64,HDN,	
14	2001212	6	LOCKWASHER,SPLIT RING, 1/2 ,LHT,YEL ZN	
15	1003094	6	NUT,HEX HD,1/2-13,GR 8,YEL ZN DICH	
16	1636943	6	PIN,FLG HEAD,HUCKSPIN,.50X2.22,HSP8	
17	1636968	6	COLLAR,HUCKSPIN,.50,HSCH-R16	
18	0803213	16	CAPSCREW,HEX HD,3/8-16X1 1/4,GR8,YEL	
19	1107085	32	WASHER,FLAT,13/32 X 13/16 X 3/32,HDN,BLK	
20	0826297	16	NUT,HEX HD,3/8-16 LOCK,YEL ZN DICH	
21	0034325	1	BRACKET,MTG,DRIVELINE CTR BRG,232 WB,	