

---

# AIR SEAL REPLACEMENT INSTRUCTIONS

---

## NOTES:

- A. Access is needed to the air seal. Room may need to be removed or retracted further into the coach. Consult vehicle manufacturer for access procedures and safety precautions.
- B. After installation is complete, the air seal may need to be pressurized for 12 hours to conform to room.
- C. Air seal is designed to fill 3/8" nominal gap, maximum allowable gap is 1/2". If larger gaps are present, consult vehicle manufacturer.
- D. Read through instructions completely before starting.

## STEPS FOR SEAL REPLACEMENT

1. Remove old air seal by first removing seal retainers. Take care not to damage the hose when removing it from the hole in the track. Existing hose may be reused if enough slack is present, or new hose installed on seal may be used. If a wiper brush is installed next to the seal, use 2 inch masking tape to keep bristles out of the way (see DETAIL A).
2. Remove tape (if installed) from track (see DETAIL B). Old tape will come off in small pieces. Adhesive will come with tape if done carefully. Do not scrape. No solvent or cleaner is known to help remove the old tape.
3. Examine track and room for sharp objects or edges that may damage the air seal.
4. Clean track with acetone. Follow manufacturer's precautions and directions for use when handling cleaning solvents. Insure track joints are sealed after cleaning. Allow track at least 5 minutes to dry.
5. Install new tape (3M #4658F) to track, leave liner on tape until steps 10 and 18 (see DETAIL B).
6. Clean back side of seal (see DETAIL C) using acetone. Follow manufacturer's precautions and directions for use when handling cleaning solvents. Completely saturate a small piece of lint free paper towel or cloth with cleaning solvent. Using the saturated towel, wipe the seal in one direction only. Wipe seal until all mold release is removed. Do not clean over the seam or the air seal stem (see DETAIL G). Stay approximately 2" from these areas. A clean towel is important. Do not allow residue to build up on the towel. Allow seal to dry at least 5 minutes. Do not soak seal in cleaning solvent. Do not allow solvent near stem or seam.
7. Apply 3M Primer 94 to cleaned area on seal (see DETAIL C). Follow manufacturer's precautions and directions. Shake well. Apply a thin uniform coating to the seal. Use a brush or piece of lint free cloth. Allow Primer 94 to dry at least 5 minutes but not more than 2 hours before installing seal. Keep the primed surface free from contaminants during seal installation.
8. Before installing new seal, test seal regulator pressure. With maximum system pressure input to regulator, output pressure should be between 12 psi and 15 psi. Do not exceed 15 psi in seal.
9. Starting at the hole in the track for the seal stem, pull back approximately 12" of the tape liner. Do not tear it off or remove it at this point. Take care to avoid contaminating the exposed adhesive (see DETAIL H).
10. Install air seal stem into hole in track. Use existing hose or hose attached to new seal. To remove new hose from seal, carefully cut hose off stem. Do not nick or scratch barbs on stem. To install existing hose onto air seal stem, wet barbs with soapy water and push hose onto barbs. Make sure all four barbs are covered by hose.
11. Install seal along bottom to tangents of each bottom corner. Snap into place (see DETAIL E & FIGURE 1).
12. Using 1 inch long retainer pieces, stake both sides of each corner on bottom tangent points. Only insert 1" retainers half way down. This will make removing them later, easier (see DETAIL F).
13. Stretch seal across corner and stake down at the vertical tangent points. Note: Seal must go across corner not into corner. Failure to do so can cause a buckle in corner and no seal contact with room (see FIGURE 1).
14. Find center of remaining seal, use 1" retainer pieces to stake at center of top (see FIGURE 2).
15. Apply seal across top of opening and snap in place. Add 1" retainer to horizontal tangents (see FIGURE 3).
16. Stretch seal across top corners and stake down at vertical tangent points. Note: Seal must go across corner, not into corner. Failure to do so can cause a buckle in a corner and no seal contact with room (see FIGURE 4).
17. Finish positioning the seal into the track on the sides insuring a uniform fit all around the track. If not uniform, remove appropriate retainers and adjust seal and restake tangent points (see DETAIL E).
18. Remove the tape liner from under the air seal 12" at a time. Press the retainers into the inside groove and then into the outside groove 12" at a time. Remove the 1" temporary retainer pieces only when needed to advance retainer around the track (see DETAIL D). Use a 5% soapy water solution to aid in retainer installation. Dip a rag in the solution and wipe retainer to apply soapy water. Do not get the double sided tape wet. Be sure retainer is fully seated.

**IMPORTANT: After the seal is completely installed, inflate the seal to a MAXIMUM of 5 p.s.i. and check for leaks or buckling in the corners before reinstalling the room.**

# AIR SEAL REPLACEMENT INSTRUCTIONS

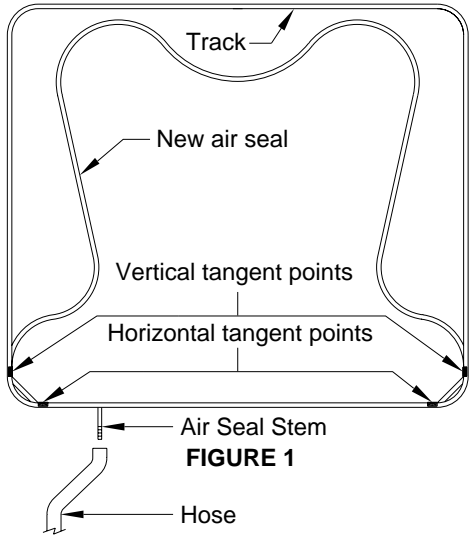

**FIGURE 1**

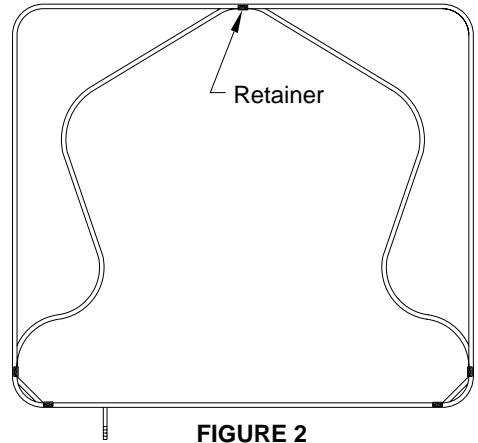

**FIGURE 2**

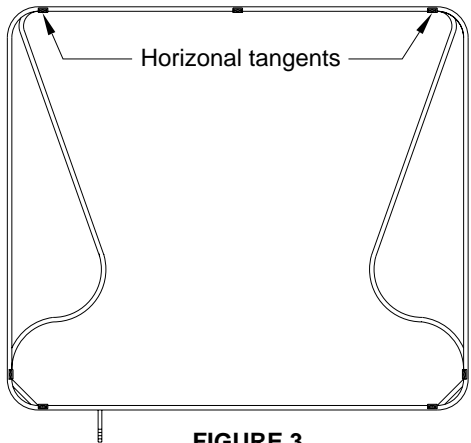

**FIGURE 3**

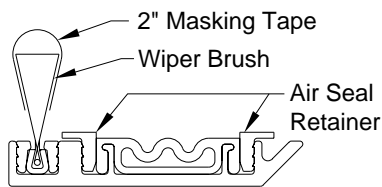

**DETAIL A**

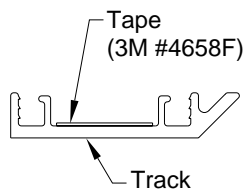

**DETAIL B**

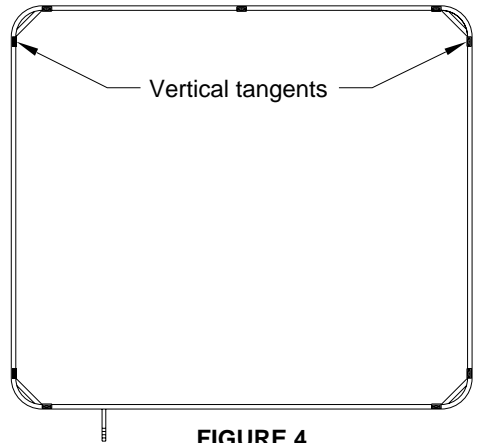

**FIGURE 4**

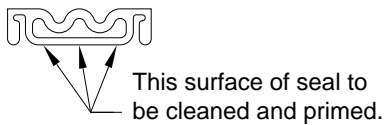

**DETAIL C**

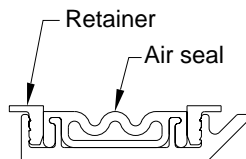

**DETAIL D**

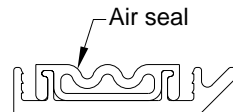

**DETAIL E**

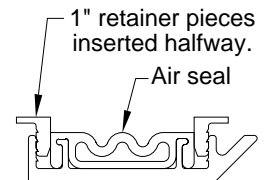

**DETAIL F**

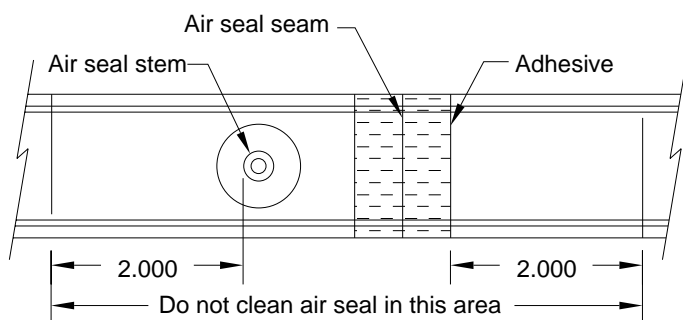

**DETAIL G**

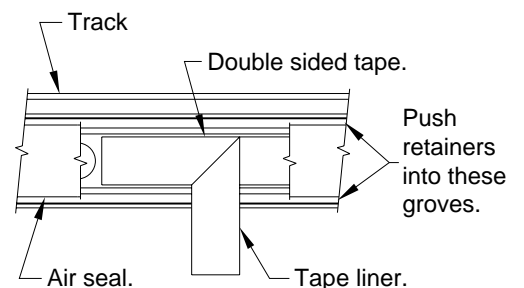

**DETAIL H**