

INDICATOR LIGHTS  
 REMOTE THERMOMETER  
 REMOTE THERMOMETER  
 REMOTE THERMOMETER

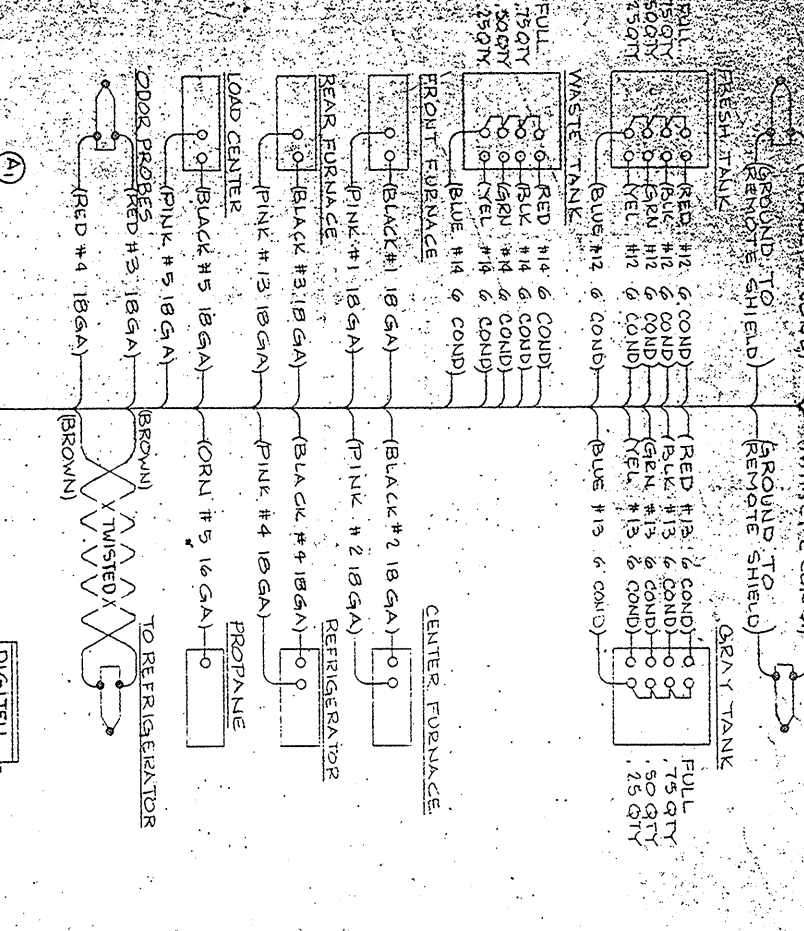

A.C. MONITOR

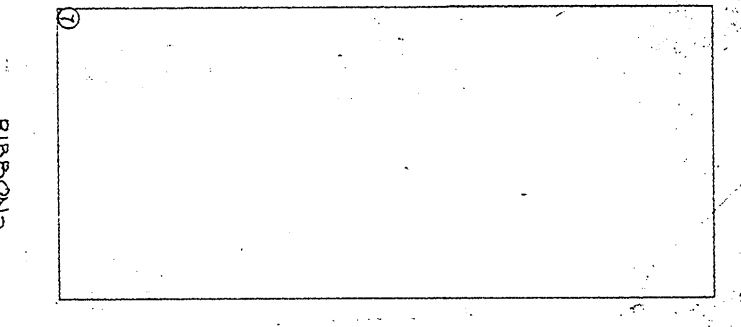

RIGHT SIDE OF SITE VIEW  
 LEFT SIDE OF SITE VIEW

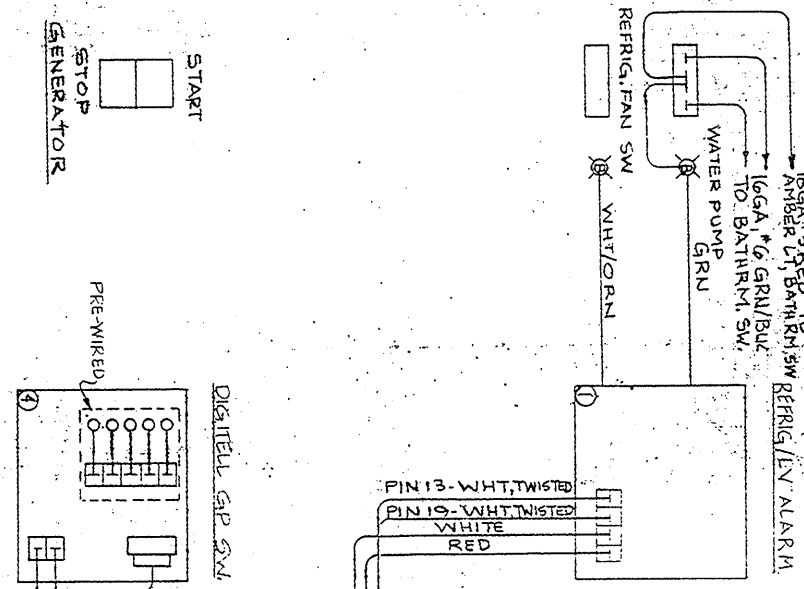

GAS/SMOKE ALARM

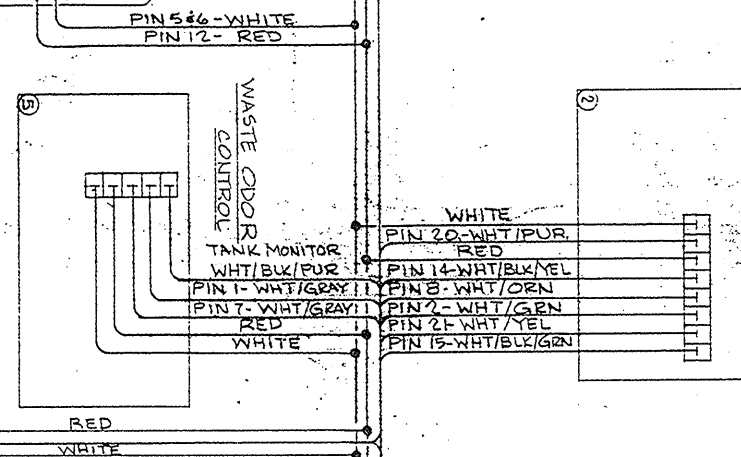

CLOCK/THERMOMETER

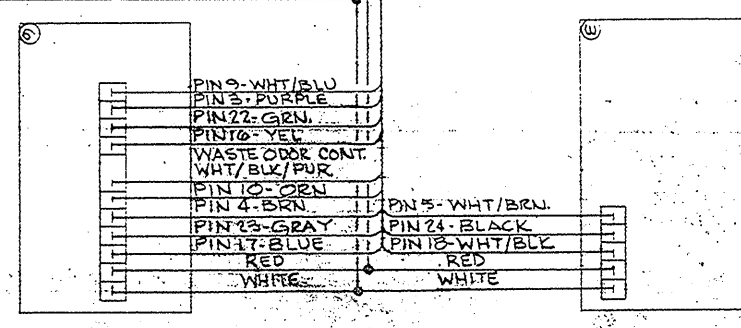

TANK MONITOR

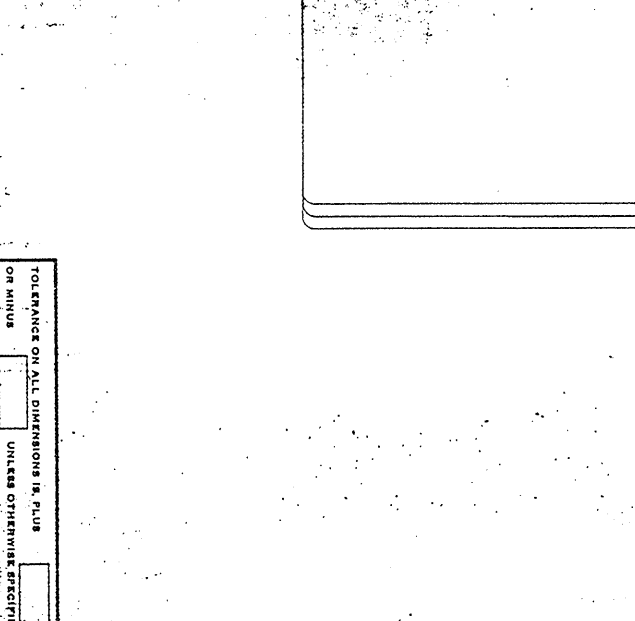
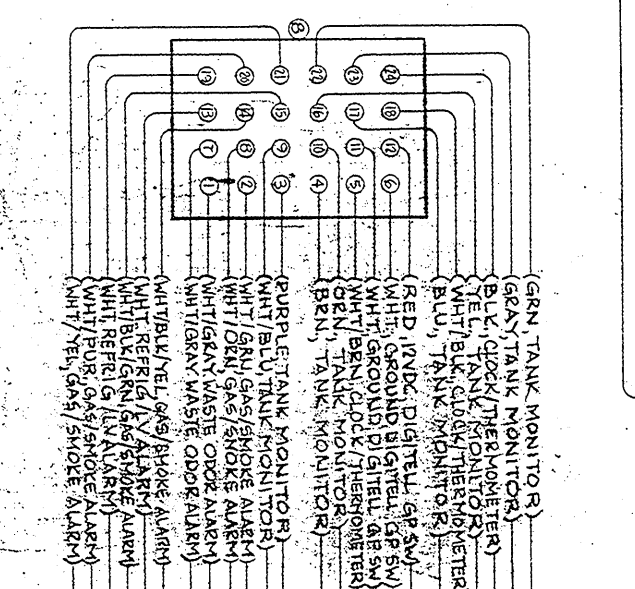
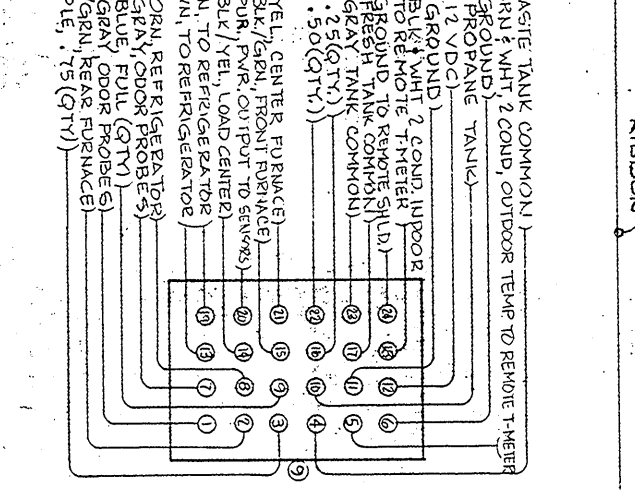
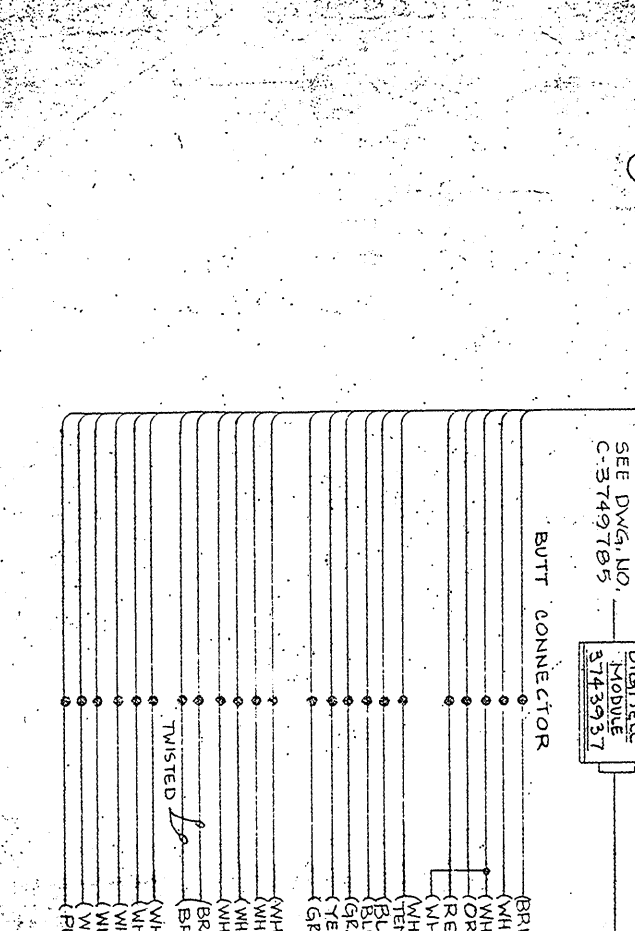
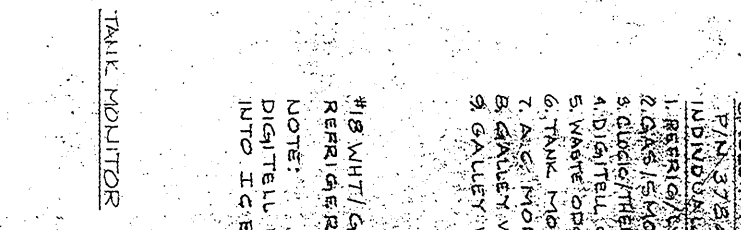

Blue Bird Wanderlog, Inc. 3749597

REV.	DATE	BY	DESCRIPTION
1			REDRAWN AND ADDED FIELD WIRING

Blue Bird Wanderlog, Inc. 3749597

DIAGRAM WIRING GALLEY PANEL

WILLIP & WILCO

DR: 15-023 B.C. BURRILL  
 CK: DO NOT SCALE

GALLEY PANEL COMPLETE  
 P/N 3784998 - 2pp 1/27/24  
 INDIVIDUAL COMPONENTS:  
 1. REFRIG. COMP. P/N 3749597  
 2. GAS/SMOKE ALARM P/N 3749597  
 3. CLOCK/THERMOMETER P/N 3749597  
 4. DIGITAL SR SW P/N 3749597  
 5. WASTE ODOR CONTROL P/N 3749597  
 6. TANK MONITOR P/N 3749597  
 7. A.C. MONITOR P/N 3749597  
 8. GALLEY WIRE HARNESS P/N 3749597  
 9. GALLEY WIRE HARNESS P/N 3749597

#18 WHT/GRN 16 GA., 2 WIRES TO REFRIGERATOR SWITCH.

NOTE: DIGITEL MODULE TAPS PLUGS INTO IC BOARD #4.

TOLERANCE ON ALL DIMENSIONS IS PLUS OR MINUS UNLESS OTHERWISE SPECIFIED.

INACTIVATES NOS

REPLACES 07-0100